

electronics

A MCGRAW-HILL PUBLICATION PRICE 75 CENTS

ANTENNAS for GUIDED MISSILES page 166

Color From Monochrome Slides page 169

Basic Logic Circuits page 196



CHECKING AUTOPILOT
OF JET DRONE MISSILE



DOTS

Deci-ouncer Transformers

REVOLUTIONARY TRANSISTOR TRANSFORMERS

of unequalled power handling capacity and reliability

TYPICAL DOT PERFORMANCE CURVES

Power curves based on setting output power at 1 KC, then maintaining same input level over frequency range.

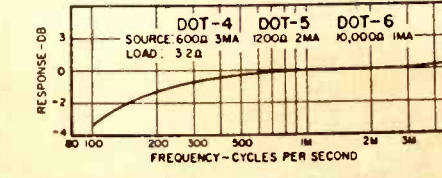
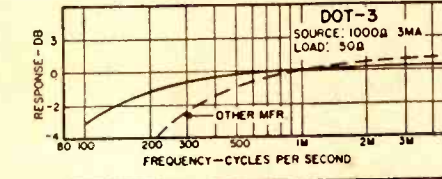
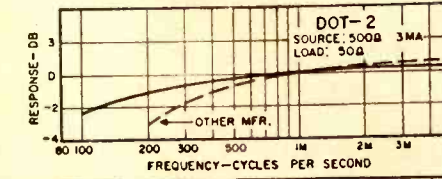
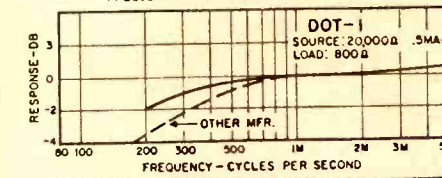
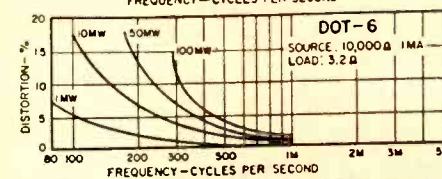
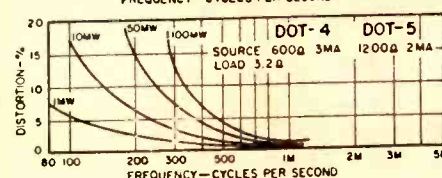
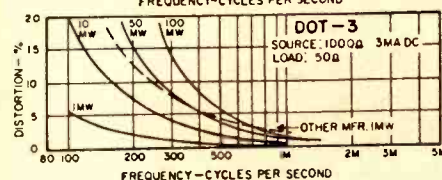
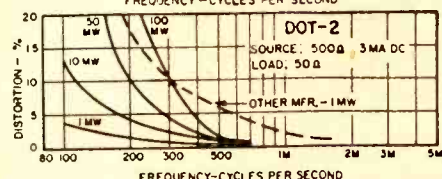
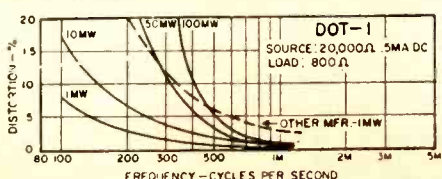

Conventional miniaturized transistor transformers have inherently poor electrical characteristics, perform with insufficient reliability and are woefully inadequate for many applications. The radical design of the new UTC DOT transistor transformers provides unprecedented power handling capacity and reliability, coupled with extremely small size. Twenty-two stock types cover virtually every transistor application. Special types can be made to order.

High Power Rating . . . up to 100 times greater.

DOT-1 has 5% distortion at 100 mw, other mfr. 6% at 1 mw.

Excellent Response . . . twice as good at low end.

DOT-3 is down 1 db at 200 cycles, other mfr. is down 4 db.

Low Distortion . . . reduced 80%.

DOT-1 shows 3% distortion where other mfr. shows 20%.

High Efficiency . . . up to 30% better.

DOT-1 has 850 ohm pri. resistance, 125 ohm sec.; other mfr. approx. 1200 and 200.

Moisture Proof . . . processed to hermetic specs.

DOT units are hermetic sealed compared to other mfr. open structures.

Rugged . . . completely cased.

DOT units can withstand all mechanical stresses.

Anchored leads . . . will withstand 10 pound pull test.

Lead strain completely isolated from coil winding.

Printed Circuit Use . . . plastic insulated leads at one end.

Other variations available.

1.3X ACTUAL SIZE

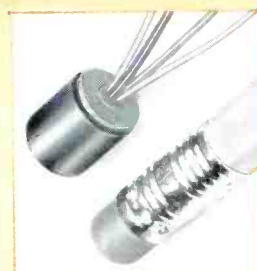

DOT CASE

Diameter 5/16"
Length 1 3/32"
Weight 1/10 oz.

Type No.	Application	Level Mw.	Pri. Imp.	D.C. Ma.± in Pri.	Pri. Res.	Sec. Imp.
DOT-1	Interstage	50	20,000 30,000	.5 .5	850	800 1200
DOT-2	Output	100	500 600	3 3	60	50 60
DOT-3	Output	100	1000 1200	3 3	115	50 60
DOT-4	Output	100	600	3	60	3.2
DOT-5	Output	100	1200	2	115	3.2
DOT-6	Output	100	10,000	1	1000	3.2
DOT-7	Input	25	200,000	0	8500	1000
DOT-8	Reactor 3.5 Hys. @ 2 Ma. DC				630	
DOT-9	Output or driver	100	10,000 12,500	1 1	930	500 CT 600 CT
DOT-10	Driver	100	10,000 12,500	1 1	930	1200 CT 1500 CT
DOT-11	Driver	100	10,000 12,500	1 1	930	2000 CT 2500 CT
DOT-12	Single or PP output	500	150 CT 200 CT	10 10	11	12 16
DOT-13	Single or PP output	500	300 CT 400 CT	7 7	20	12 16
DOT-14	Single or PP output	500	600 CT 800 CT	5 5	43	12 16
DOT-15	Single or PP output	500	800 CT 1070 CT	4 4	51	12 16
DOT-16	Single or PP output	500	1000 CT 1330 CT	3.5 3.5	71	12 16
DOT-17	Single or PP output	500	1500 CT 2000 CT	3 3	108	12 16
DOT-18	Single or PP output	500	7500 CT 10,000 CT	1 1	505	12 16
DOT-19	Output to line	500	300 CT	7	19	600
DOT-20	Output or matching to line	500	500 CT	5.5	31	600
DOT-21	Output to line	500	900 CT	4	53	600
DOT-22	Output to line	500	1500 CT	3	86	600

±DCMA shown is for single ended useage (under 5% distortion—100MW—1KC) . . . for push pull, DCMA can be any balanced value taken by .5W transistors (under 5% distortion—500MW—1KC)

UNITED TRANSFORMER CO.

150 Varick Street, New York 13, N. Y. • EXPORT DIVISION: 13 E. 40th St., New York 16, N. Y.

CABLES: "ARLAB"

PACIFIC DIVISION: 4008 W. JEFFERSON BLVD., LOS ANGELES 16, CALIF.

*DOT units have been designed for transistor applications only . . . not for vacuum tube service **Pats. Pending

A McGRAW-HILL PUBLICATION

H. W. MATEER, *Publisher*
W. W. MacDONALD, *Editor*

Managing Editors
VIN ZELUFF
JOHN M. CARROLL

Feature Editor
JOHN MARKUS

Associate Editors
ALEXANDER A. McKENZIE
JOHN M. KINN, Jr.
FRANK LEARY
MICHAEL F. TOMAINO
HOWARD K. JANIS
SYLVESTER P. CARTER

Assistant Editors
WILLIAM P. O'BRIEN
WILLIAM G. ARNOLD
DAVID A. FINDLAY
HAI G. A. MANOOGIAN
GEORGE SIDERIS
LAWRENCE KAMARCK
EDWARD DeJONGH
JOHN F. MASON

Pacific Coast Editor (Los Angeles)
HAROLD C. HOOD

Midwestern Editor (Chicago)
HAROLD HARRIS

New England Editor (Boston)
ROLAND J. CHAREST

HARRY PHILLIPS, *Art Director*
ROY THOMPSEN
BARBARA ELLWOOD
JOHN C. WRIGHT, Jr., *Production*
JEAN L. MATIN

Editorial Assistants
GLORIA J. FILIPPONE
ARLENE SCHILP
BERNICE DUFFY
BARBARA HEARST
NOREEN HENNESSY
PHYLIS A. CRONIN
BARBARA M. SHAW

JAMES GIRDWOOD, *Adv. Sales Mgr.*
R. S. QUINT, *Assistant Adv. Sales Mgr. and Buyers' Guide Mgr.*
FREDERIC STEWART, *Promotion Mgr.*
FRANK H. WARD, *Business Mgr.*
G. E. POMEROY, *Classified Mgr.*
JEAN W. HEIGES, *Research*
WALLACE B. BLOOD, *Market Consultant*

New York
DONALD H. MILLER
HENRY M. SHAW
MARTIN J. GALLAY

Boston
WM. S. HODGKINSON

Philadelphia
JAMES T. HAUPTLI

Chicago
BRUCE WINNER
WALTER M. LUCE

Cleveland
WARREN H. GARDNER

San Francisco
T. H. CARMODY
R. C. ALCORN

Los Angeles
CARL W. DYSINGER

Atlanta
R. H. POWELL

Dallas
GORDON L. JONES

London
HERBERT LAGLER
KEITH HENNEY, *Consultant*

CHECKING AUTOPILOT OF JET DRONE MISSILE—Technicians work on autopilot tray assembly of Ryan Firebee turbojet pilotless plane. Drone is capable of serving as 600-mph ground-controlled target for guided missiles or as missile itself (see p 182). Photo by David A. Gossett. **COVER**

SHOPTALK **2**

FIGURES OF THE MONTH **6**

INDUSTRY REPORT **7**

Computers In Canada	7	Small Sets Do Business	20
New Amplifier Gains	7	Experimental Radio Expands	20
More Radar Picket Ships	7	FCC Actions	22
Transistor Registrations	8	Computer Centers Increase	22
Multiplex F-M Gains	8	Electronics Sinks New Roots	24
Magnistors Catch On	10	Financial Roundup	24
Business Briefs	10	Magnetron Research	24
Snark Finds Its Way	12	Radar-Computer Finds Mortars	26
Magnetic Recording Grows	12	Envelope Sales Growing	26
New Batteries Bow	14	Stand-in For Atlas	28
Military Electronics	14	Meetings Ahead	28
1957 IRE National Convention	16	Industry Shorts	28
Electronics Output Pace	16		

CROSSTALK **155**

FEATURES

Ultrasonic Gong Controls TV Sets	156
By Robert Adler, Peter Desmares and John Spracklen	
Solar-Flare Detection for IGY	162
By Robert H. Lee	
Beacon Antennas for Guided Missiles	166
By W. E. Barrick and D. L. Brannon	
Monochrome Slides Broadcast Color	169
By Edward L. Covington	
Measuring Corona from Radioactive Point	172
By R. W. Hendrick Jr., F. C. Martin and Seville Chapman	
Simple Sync Circuits Time ITV Systems	174
By Haig A. Manoogian	
Air-Drop System Broadcasts Message	179
By F. C. Fischer, A. A. Gerlach and D. S. Schover	
Ground-Controlled Drone Tests Missiles	182
By Forrest Warren and Carlton Corden	
Wide-Range Analyzer Traces Precise Curves	184
By Edward F. Feldman	

Intercarrier Failure Rings Alarm.....	188
By Kenneth Atwood	
Boosting Transistor Switching Speed.....	190
By Richard H. Baker	
Dual-Triode Tester Measures Tube Balance.....	194
By Ronald L. Ives	
Basic Logic Circuits for Computer Applications.....	196
By G. W. Booth and T. P. Bothwell	
Sweeper Determines Power-Gain Parameter.....	201
By W. N. Coffey	
Transistor Transformer Design Nomographs (Reference Sheet).....	204
By C. J. Savant and C. A. Savant	

ELECTRONS AT WORK..... 208

Atmosphere Affects Propagation.....	208	Rectifier Locomotive.....	220
Sleeve Radiator for TV.....	208	By J. E. Wallace and J. L. Zehner	
By George P. Kearse		Ultrasonic Cleaner.....	224
Canada Computing Center.....	210	Small Missile Recorder.....	228
Light Actuated Counter.....	212	Movable-Anode Tube.....	232
By John Grant		Voltage Multiplier.....	236
Remote Boiler Analysis.....	212	Tester Checks Grid Emission.....	238
Grid-Operated Thyatron.....	214	By E. A. Bramsen	
By L. L. Boyarsky		Rapid Missile Tester.....	242
British Research Uses TV.....	214	Effects of Radiation.....	244
Printed Circuit Attenuator.....	216	Radiation Whiskers.....	244
By John W. Fallon		Irradiated Polyethylene.....	246
Megawatt Beam Triode.....	216	Two Megawatt Klystron.....	248
C-D Alarm.....	218	Iron Dust Magnet.....	250

PRODUCTION TECHNIQUES..... 252

Shell Blast Strips Enamel.....	252	Plug-In Toroid Assembly.....	260
New Drafting Materials.....	252	By Arthur J. Rose	
By N. J. Schuster		Tape Core Welder.....	274
Design of Month: Stepper Switch.....	254	Miniature Soldering Iron.....	276
Rollers Hold Large Circuits.....	254	Inserting Tubes in Cartons.....	278
Cutting Long Coaxial Cables.....	256	Hermetic Seal Leak Detector.....	284
Press Crimps Metal on Ceramic.....	259	By B. W. Schumacher	
Solder-Flux Dispenser.....		294	

NEW PRODUCTS..... 296

LITERATURE..... 422

PLANTS AND PEOPLE..... 436

NEW BOOKS..... 473

THUMBNAIL REVIEWS..... 481

BACKTALK..... 485

INDEX TO ADVERTISERS..... 553

SHOP

► **DATA HANDLING** . . . Statistics on some segments of the industry are indeed difficult to obtain, for various commercial reasons. Most companies are cooperative, and we are truly thankful.

To obtain some material for this month's *Industry Report*, assistant editor Arnold long-distanced a dozen companies. Most supplied figures immediately on the phone.

One made bingo in its cooperation, however. It telegraphed the reply, six pages of business statistics!

► **GRACIOUS** . . . Occasionally an author is in a position where he cannot accept a check we have sent him in payment for a manuscript.

Recently we noted that one author, R. R. Unterberger of California Research Corp., LaHabra, California, endorsed his check over to Whittier College, to further its liberal arts educational program.

► **BRAIN FOOD** . . . Readers in certain parts of the world have problems peculiar to the climate; many of us in temperate zones do not fully appreciate them.

The following suggestion has been received from Frank Watlington, chief electronics engineer at a geophysical field station of Columbia University.

"Of interest to your readers may be the following. We have had a great deal of trouble in Bermuda due to the fact that cockroaches find the backs of your magazines

electronics

MARCH 1, 1957

Vol. 30, No. 3



Member ABC and ABP

TALK

excellent feeding material, and sooner or later they consume it to a point where the cover falls off.

"We have been able to discourage them by spraying the backs with a clear acrylic protective coating."

► **WAS OUR SECRET . . .** Letters from a company making high-fidelity equipment have a pair of musical notes typed right at the beginning of each paragraph. The effect is quite pleasing and serves to remind the recipients of the company's products.

For many months **ELECTRONICS** has used an intentionally ambiguous device for a similar purpose. It's the integration sign that starts the word **SUMMARY** up near the top of each feature article. We would have preferred to use a summation sign but shuddered at the appearance of Σ UMMARY. So did the print shop.

Even the integration sign we use is not on a typesetting machine; it is made as a cut which, in the mechanics of the printing business, meets the type only in one of the final operations. For many months the printer's proofreader sent galleys to us questioning **UMMARY**.

► **DATA STORAGE . . .** Perennial problem for readers (and editors) is that of keeping copies of **ELECTRONICS** and other periodicals out of normal traffic patterns around the house. A centralized storage system that also provides ready access for quick-look pur-



ELECTRONICS stacks nicely in shelving spaced for maximum utilization of space

poses has been built by feature editor Markus for his cellar. Shelf space totals 96 feet.

Even this isn't enough for orderly storage of the technical material that accumulates for reference. As a result, the one-of-each items get piled on the top shelves and those at the lower rear. Only the guy who put them there can find what he wants, provided no one else tries to house-keep the mess.

Construction hints: No. 2 pine, with one coat rubbed-effect varnish. Shelves run full 16-ft length. Risers are 12 inches, lightly nailed between shelves since weight of magazines holds them in position. Back is quarter-inch plywood.

Assembled upright in middle of room, back sheets were nailed on, then entire unit slid into position against wall and top trim added. Height, 7 feet. A dehumidifier was found essential.

Published three times a month, with an additional issue in June, by McGraw-Hill Publishing Company, Inc., James H. McGraw (1860-1948), Founder. Executive, Editorial and Advertising Offices: McGraw-Hill Building, 330 W. 42 St., New York 36, N. Y. Longacre 4-3000. Publication Office, 99-129 North Broadway, Albany 1, N. Y. Donald C. McGraw, President; Joseph A. Gerardi, Executive Vice President and Treasurer; John J. Cooke, Secretary; Nelson Bond, Executive Vice President, Publications Division; Ralph B. Smith, Vice President and Editorial Director; Joseph H. Allen, Vice President and Director of Advertising Sales; A. R. Venezian, Vice President and Circulation Coordinator. Subscriptions: Address correspondence to **Electronics**—Subscription Service, 330 W. 42nd St., New York 36, N. Y. Allow one month for change of address. Subscriptions are solicited only from persons engaged in theory, research, design, production, maintenance and use of electronic and industrial control components, parts and products. Position and company connection must be indicated on subscription orders.

Single copies 75¢ for Technical Edition and 50¢ for Business Edition in United States and possessions, and Canada; \$1.50 and \$1 for Latin America; \$2.00 and \$1.50 for all other foreign countries. Buyers' Guide \$3.00. Subscription rates—United States and possessions, \$6.00 a year; \$9.00 for two years. Canada, \$10.00 a year; \$16.00 for two years. Other western hemisphere countries and the Philippines, \$15.00 a year; \$25 for two years. All other countries \$20.00 a year; \$30.00 for two years. Three-year rates accepted on renewals only, are double the one-year rate. Entered as second-class matter August 29, 1936, at the Post Office at Albany, N. Y., under act of Mar. 3, 1879. Printed in U.S.A. Copyright 1957 by McGraw-Hill Publishing Co., Inc.—All Rights Reserved. BRANCH OFFICES: 320 North Michigan Avenue, Chicago 11, Ill.; 68 Post Street, San Francisco 4; McGraw-Hill House, London E. C. 4; National Press Bldg., Washington, D. C. 4; Architects Bldg., 17th & Sansom Sts., Philadelphia 3; 1510 Hanna Bldg., Cleveland 15; 856 Penobscot Bldg., Detroit 26; 3615 Olive St., St. Louis 8; 350 Park Square Bldg., Boston 16; 1321 Rhodes Hagerly Bldg., Atlanta 3, Ga.; 1125 West Sixth St., Los Angeles 17; 919 Oliver Building, Pittsburgh 23. **ELECTRONICS** is indexed regularly in The Engineering Index.

at last a completely new kind of regulator!



ACTUALLY THREE REGULATORS IN ONE—PLUS MULTIPLE SENSING!

The APR 1010 combines many new regulation and sensing systems in one versatile package. Here's flexibility of operation never before possible . . . saves space, eliminates instrument duplication, means greater economy in engineering operations.

- RMS VOLTAGE REGULATION
 - AVERAGE REGULATION
 - PEAK REGULATION
 - FIVE PRINCIPAL SENSING ARRANGEMENTS
1. INTERNAL 2. EXTERNAL 3. REMOTE 4. CONSTANT CURRENT 5. DC

ELECTRICAL CHARACTERISTICS:

Input	95-130 VAC, 1 ϕ (50 or 60 cps \pm 10%)
Output	115 VAC, adj. 110-120V
Regulation accuracy (RMS, average, or peak, switch selected)	\pm 0.1% against line \pm 0.1% against load
Distortion	3% max.
Load	0-1000VA
P.F. range	Unity to 0.7 lagging
Recovery time	0.1 sec.

Write for complete technical data.



See the new
APR 1010
at Booths 2627-9
I.R.E. Show!

SORENSEN & COMPANY, INC.



STAMFORD • CONN.

In Europe, contact Sorensen-Ardag, Eichstrasse 29, Zurich, Switzerland, for all products including 50 cycle, 220 volt equipment.



246/C

YOUR COPY OF 'TECHNIQUE'

Many readers have expressed their surprise and pleasure at the amount of information, free from irrelevant matter, that is to be found in our journal of instrument engineering 'TECHNIQUE'.

Each quarterly issue contains articles on the latest developments and applications of Muirhead instruments. Included in the April issue, Volume 11, No. 2, is the article 'Unusual Applications of Magslips', also the latest news on 'Muirhead Synchros'.

On receipt of your enquiry, we will place your name on our mailing list for this journal.

SEE US AT THE I.R.E. SHOW, NEW YORK

We invite you to our Booth No. 3230 where we shall be demonstrating the Muirhead Synchro Test Equipment. Bring a 115V 400c/s Control Synchro Type 11, 15, 18 or 23 and have it checked to MIL Specification. See that the Synchro Manufacturer's Test Equipment is your synchro test equipment. Described in Publication 7741.

MUIRHEAD

MUIRHEAD INSTRUMENTS INC. • 677 Fifth Avenue • New York 22 • N.Y. • U.S.A.
MUIRHEAD INSTRUMENTS LIMITED • STRATFORD • ONTARIO • CANADA
MUIRHEAD & CO. LIMITED • BECKENHAM • KENT • ENGLAND

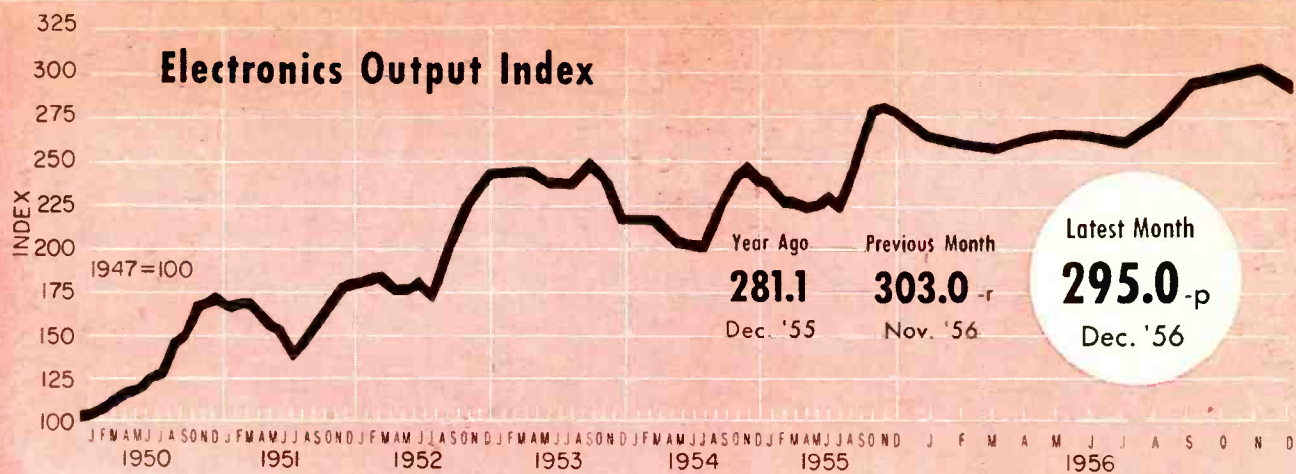

FIGURES OF THE MONTH

	Latest Month	Previous Month	Year Ago		Latest Month	Previous Month	Year Ago
RECEIVER PRODUCTION				BROADCAST STATIONS			
(Source: RETMA)				(Source: FCC)			
Television sets, total	Dec. '56	Nov. '56	Dec. '55	TV stations on air	Jan. '57	Dec. '56	Jan. '56
With UHF	626,984	679,993	604,626	TV stations CPs—not on air	513	511	484
Color sets	104,205	116,183	89,606	TV stations—new requests	120	120	105
Radio sets, total	nr	nr	nr	A-M stations on air	62	59	26
With F-M	1,715,209	1,381,831	1,786,330	A-M stations CPs—not on air	3,014	3,008	2,834
Auto sets	513	2,326	40,305	A-M stations—new requests	123	117	120
	840,359	609,139	864,261	F-M stations on air	288	291	242
				F-M stations CPs—not on air	527	530	538
				F-M stations—new requests	24	24	16
					8	5	3

	Dec. '56	Nov. '56	Dec. '55
RECEIVER SALES			
(Source: RETMA)			
Television sets, units	957,193	560,391	933,467
Radio sets (except auto)	1,651,950	689,409	1,388,801

	Dec. '56	Nov. '56	Dec. '55
RECEIVING TUBE SALES			
(Source: RETMA)			
Receiv. tubes, total units	34,340,000	39,489,000	38,049,000
Receiv. tubes, value	\$29,111,000	\$31,476,000	\$30,673,000
Picture tubes, total units	795,476	957,765	881,465
Picture tubes, value	\$13,423,157	\$16,014,839	\$17,533,105

	Quarterly Figures		
	Latest Quarter	Previous Quarter	Year Ago
INDUSTRIAL TUBE SALES			
(Source: NEMA)			
Vacuum	3rd '56	2nd '56	3rd '55
Gas or vapor	\$8,895,012	\$7,680,250	\$9,027,845
Magnetrons and velocity modulation tubes	\$2,936,765	\$2,983,488	\$3,438,835
Gaps and T/R boxes	\$14,948,477	\$16,254,025	\$10,998,967
	\$1,196,369	\$1,238,469	\$1,421,138

	3rd '56	2nd '56	3rd '55
MILITARY PROCUREMENT			
(Source: Defense Dept.)			
Army	\$23,107,000	\$44,882,000	\$19,477,000
Navy	\$22,273,000	\$34,132,000	\$20,054,000
Air Force	\$84,952,000	\$128,781,000	\$128,023,000
Total—Electronics	\$130,332,000	\$207,795,000	\$167,554,000

	Dec. '56	Nov. '56	Dec. '55
COMMUNICATION AUTHORIZATIONS			
(Source: FCC)			
Aeronautical	54,231	53,192	44,836
Marine	60,390	60,153	53,950
Police, fire, etc.	22,066	21,829	19,885
Industrial	33,046	32,788	27,269
Land transportation	9,346	9,287	8,481
Amateur	155,203	154,839	142,819
Citizens radio	22,463	22,036	14,426
Disaster	330	330	321
Experimental	764	775	674
Common carrier	2,585	2,559	2,093

	Nov. '56	Oct. '56	Nov. '55
EMPLOYMENT AND PAYROLLS			
(Source: Bur. Labor Statistics)			
Prod. workers, comm. equip.	423,900-p	418,400-r	409,400
Av. wkly. earnings, comm.	\$78.74-p	\$78.12	\$75.53
Av. wkly. earnings, radio	\$74.96-p	\$75.70-p	\$71.81
Av. wkly. hours, comm.	40.8 -p	40.9	41.5
Av. wkly. hours, radio	40.3 -p	40.7 -r	40.8

	Oct. '56	Sept. '56	Aug. '56*
SEMICONDUCTOR SALES ESTIMATES			
Transistors, Units	1,290,000	1,155,000	1,315,000

	Jan. '57	Dec. '56	Jan. '56
STOCK PRICE AVERAGES			
(Source: Standard and Poor's)			
Radio-tv & electronics	336.3	345.2	435.6
Radio broadcasters	439.9	454.1	500.5
	p—provisional	r—revised	nr—not reported
	*1955 not available		

FIGURES OF THE YEAR

	1956	1955	Percent Change
Television set production	7,357,029	7,756,521	- 5.2
Radio set production	13,981,800	14,894,695	- 6.1
Television set sales	6,804,756	7,421,084	- 8.3
Radio set sales (except auto)	8,332,077	6,921,384	+ 20.4
Receiving tube sales	464,186,000	479,802,000	- 3.3
Cathode-ray tube sales	10,987,021	10,874,234	+ 1.0

INDUSTRY REPORT

electronics—March 1 • 1957

Computers Multiply In Canadian Market

Doubled sales in three years indicate bright future for all computer types

PROCESS industries as well as aircraft, electrical-electronic and chemical are responsible for the growth of the computer industry in Canada. The pulp and paper industry, primarily a Canadian market, offers several possible applications for analog computers in the fields of pH control in sulphite mills, pipe line pulsation studies as well as heat-balance studies between groundwood and paper mills.

► **Digital**—It is estimated that the next five years will see about 50 large digital computers installed in Canada. Outlook for the small and medium sized units is more optimistic with an estimated 150 units installed during the same period.

► **Analog**—Potential sales of analog units are difficult to estimate owing to the number of unexplored applications that exist, however it appears that the next three years should see sales of general-purpose units climb from \$700,000 to \$1.5 million.

► **Latest**—Most recent example of the expanding computer business is the opening of a computing center at Bells Corners, Ontario, by Computing Devices of Canada Ltd. The center contains a specially built Reac computer having a total of 96 amplifiers.

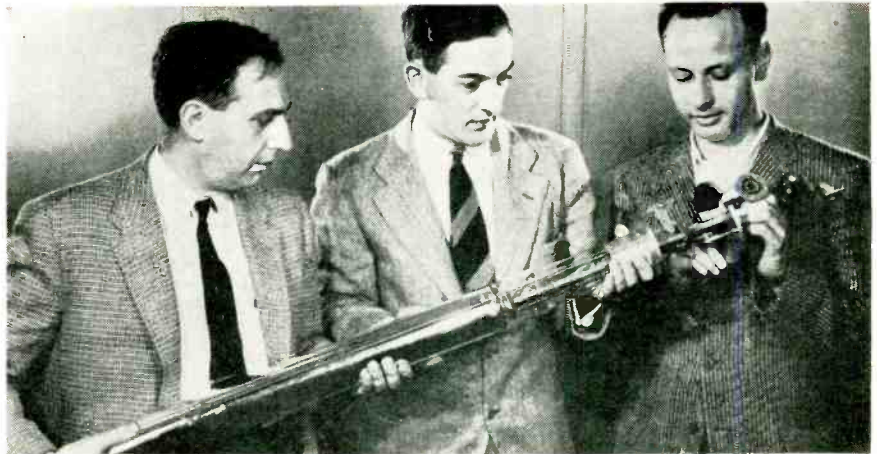

ENGINEERS of BTL hold experimental solid-state oscillator showing how . . .

New Amplifier Gains Are Forecast

Solid-state oscillator development leads to low-noise amplifier employing electron spin

SUCCESSFUL operation of a new solid-state microwave oscillator putting out 20 microwatts at 9,000 mc has been announced by Bell Labs where a crystal containing a small amount of paramagnetic salt was employed.

Ordinary electronic oscillators depend upon the motion of charged particles at high temperatures. Since the new device operates with electron spin in a paramagnetic crystal, it should have, according to theory, very low inherent noise.

► **Equipment**—Operating in a magnetic field, the solid-state oscillator comprises a waveguide cavity immersed in liquid helium. Energy at 17,500 kc is fed into the cavity and radiation at 9,000

mc is taken out by means of a strip waveguide.

Concurrent with the Bell Labs' announcement was one from Massachusetts Institute of Technology in which a new amplifying device called the Versitron was postulated. Uses of the amplifier to be operated at low temperature include differentiating between sources with slightly unequal temperatures and located some distance away.

More Picket Ships Join Radar Net

ELECTRONIC gear on the recently commissioned radar picket ship *USS Outpost*, YAGR-10, is valued at more than \$3 million, including installation costs.

The *Outpost* is the tenth converted Liberty ship to join the sea-going portions of the horse-shoe-shaped radar warning net



Height-finding radar aboard USS Outpost

that extends roughly from Santa Barbara, Calif. through Alaska and northern Canada, down to Savannah, Ga.

► **Firms** — The ship's electronics

officer estimates that electronic equipment on board was supplied by from 50 to 100 companies. Radar equipment includes: GE's AN/SPS-8A; Raytheon's surface search, AN/SPS-5; RCA's air search, AN/SPS-17; and Westinghouse air-search radar.

Bendix, Federal Telephone and Radio and others supplied communications equipment.

► **DER** — Beyond the ten YAGR ships now commissioned, the Continental Air Defense Command's sea surveillance includes converted destroyers known as DER's. Ships will patrol offshore and in midocean. Plans call for several hundred new radar sites which will include the chain of radar sea platforms extending 125 miles off the East Coast from Norfolk to Newfoundland.

Transistor Registrations Double

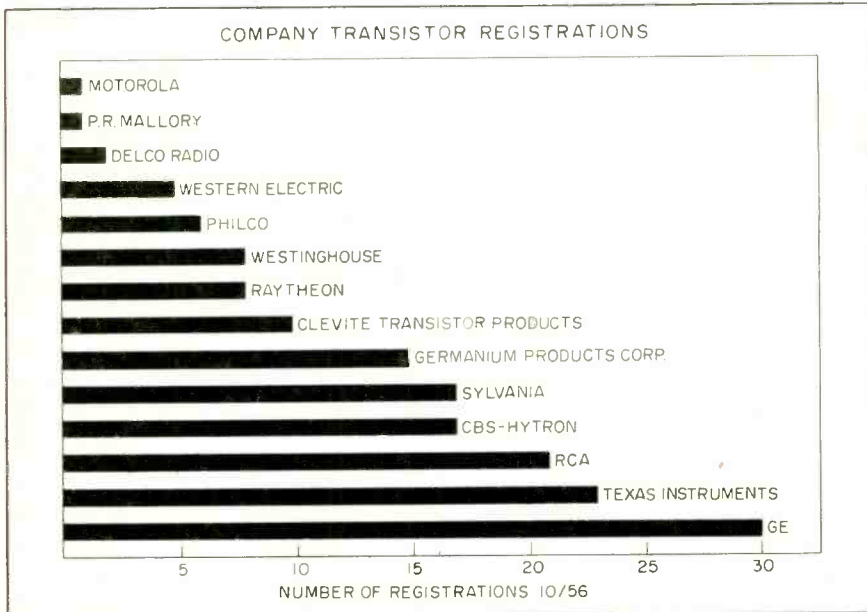

Number of types registered reached 164 in 1956, up 89 over the 1955 grand total

SUMMARY of all transistors registered through October 1, 1956 with the Joint Electron Tube Engineering Council indicates that as many of the devices were registered in the first nine months of 1956 as in all previous years combined. The number of registrations now totals over 164. Five

companies, GE, Texas Instrument, RCA, Sylvania and CBS-Hytron account for well over half of the registrations. Nine other companies had units registered.

► **Production**—Registration of a transistor type with JETEC does not mean that the type is in actual production. But, according to RETMA, it is a good indication that production is underway or will be shortly.

► **Types**—Over 90 of the registrations were for *pnp* transistors and 55 were *npn* types. The remainder were point-contact types. Although specific applications were not disclosed for many of the units, of those that were given hearing-aid applications were numerous along with switching and power output applications.

► **Production Progress**—The upward trend in registrations is expected to continue. Sylvania estimates that its production and sales of all transistor types in 1956 were about ten times the company's 1955 totals. The firm expects its transistor output this year to be about four times the 1956 total.

► **Volume**—The industry's production of transistors in 1957 will total 30 million units, according to another company. It estimates that potential uses which cannot now be foreseen will require from one-third to one-half of the industry's total transistor volume beginning in 1960.

The firm estimates that annual transistor production will reach over 290 million units by 1966.

Multiplex F-M Gathers Momentum

Subcarrier programs may replace wire lines to subscribers of background music

ESTIMATED as a market with billings in excess of \$200 million, background music is beginning seriously to consider getting its programs from studio to customer by radio rather than wire.

Two methods are available—one is temporary and the other more expensive. Until July, the Federal Communications Commission will permit operators of f-m broadcast stations to transmit programs in which announcements are accompanied by an ultrasonic, inaudible, beep. Unheard in the average receiver, the beep tone actuates controls in special subscribers' re-

(Continued on page 10)

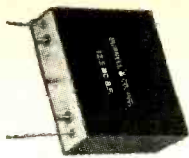

SUBMINIATURE FILTERS

- for I.F. amplifiers, printed circuit use
- temperature compensated to .15% from -55°C to $+85^{\circ}\text{C}$
- for operations above 1 mc
- dimensions: $13/16'' \times 2-1/2'' \times 2''$ high



ENCAPSULATED TOROIDS

- hermetically sealed
- high Q
- center-mounting permits stacking
- complete range of sizes and types
- dimensions: $21/32'' \times 3/8''$



TOM THUMB TELEMETERING FILTERS

- miniaturized for guided missiles
- high temperature stability
- designed to withstand shock and vibration
- hermetically sealed —wt. 1.5 oz.
- dimensions: $45/64'' \times 45/64'' \times 2''$ high



SUBMINIATURE ADJUSTORIDS

- precise continuous adjustment of inductance over a 10% range
- no external control current needed
- hermetically sealed
- low cost—wt. .83 oz.
- dimensions: $45/64'' \times 45/64'' \times 3/4''$ high



you're all set to roll...

... with a toroid, filter or related network by Burnell.

For Burnell *specializes* in these components; in manufacturing them *and* in delivering them on schedule — at competitive prices.

Today Burnell makes toroids, and the filters of which they are the basic components, small enough to meet a multitude of new purposes . . . in aircraft and guided missiles . . . in receivers, carrier and telemetering systems.

Very likely we already have the answer to your network needs among our extensive files. If not, we can swiftly find that answer for you. Try us and see.

Burnell & Co., Inc.



first in toroids, filters and related networks

45 WARBURTON AVENUE, YONKERS 2, N. Y. TELEPHONE: YONkers 5-6800 DEPT. E-37

PACIFIC DIVISION: 720 MISSION STREET, SOUTH PASADENA, CALIFORNIA TELETYPE: PASADENA 7578

You are warmly invited to visit our Booth, #2131 on the second floor of the IRE show

ceivers to step up volume (to make announcements more penetrating) or to cut out the commercial announcement entirely.

► **Multichannel Plan**—Broadcasters may obtain a subsidiary communications authorization that permits use of one or more subcarriers—each carrying a separate program—that can be picked up by appropriate receivers. While the main channel transmits classical music for hi-fi enthusiasts, the other channels can carry paid commercial programs or furnish special background music to special subscribers.

Out of some 520 f-m stations on the air, only 77 are licensed for the special services. According to one industry authority, about 60 percent are simplex (beep tone) and the rest multiplex. However, the percentages seem to be shifting in the other direction. Probably about half of those licensed are actually multiplexing now.

► **Dollar Value**—Independent market research claims an equipment potential (transmitter modulators and subcarrier receivers) of \$5 million over the next five years. This splits into \$1 million for transmitting equipment and \$4 million for receivers.

Less than half a dozen electronics manufacturers are known to be building equipment. Installations to date have been generally hand-adjusted.

Business Briefs

► **Higher sales** than a year ago are expected for the second quarter of 1957 by almost 66 percent of some 1,500 business men surveyed by Dun & Bradstreet. Profit margins were expected by many to be lower

► **Electronics** constituted at least 40 percent of Bendix Aviation's output in terms of finished products utilizing electronic circuits or controls. The firm's net sales in 1956 totaled \$581.4 million compared to \$567.2 million for 1955

► **Merger of Beckman Instruments and Statham Labs** is in the works. It will involve a stock exchange of up to 400,000 shares of Beckman for all of the Statham interests. The firm, with annual sales of \$5 million, produces precision pressure transducers, accelerometers and other devices

► **New orders** totaling \$80.9 million were booked by Lear in 1956, the largest volume in the firm's history. Backlog reached \$64.7 million compared to \$53.4 million in 1955. Much of the gain is attributed to expanded sales of automatic flight control and flight reference systems

► **World-wide sales** exceeded \$100 million in 1956 for Addressograph-Multigraph Corp., a 15-percent increase over 1955. No defense contract work was done in 1956 by either the corporation or any of its subsidiaries

Magnistors Catch On And Output Expands

Expect up to a five-fold increase in output as facilities in Puerto Rico are opened

THE magnistor, a type of saturable reactor developed by Potter Instrument about two years ago, is gaining ground fast. Today at least 10,000 of the units are in use representing a gross dollar volume of about \$200,000.

Potter recently opened a new 12,500 sq ft branch plant in Lugville, Puerto Rico to manufacture the devices. By the end of 1957

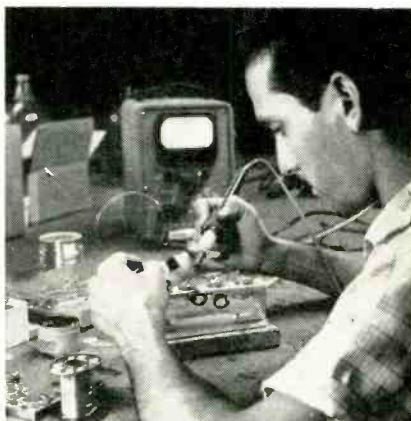

Magnistor production setup

30,000 to 50,000 of the components are expected to be in use.

► **Production**—The company set up its new magnistor plant in Puerto Rico because most coil winding machines are not delicate enough to handle the fine wire used in magnistors without breaking it. Puerto Ricans, known for their needle work and manual dexterity, do the job better and cheaper than machines. The favorable tax laws along with other economic factors also were behind the move.

The company had planned to

(Continued on page 12)

Hyrel[®] Q the most reliable capacitors available anywhere!

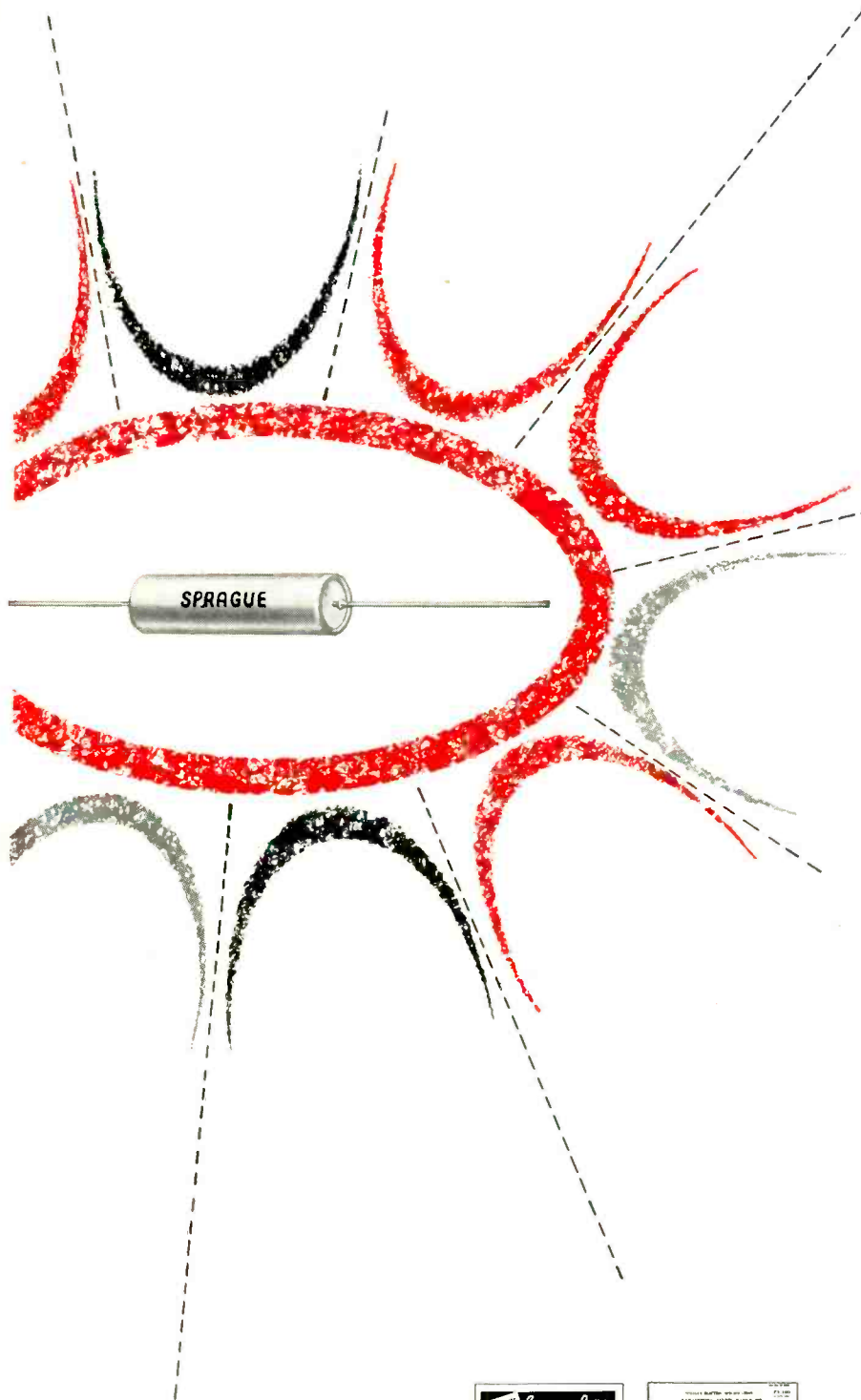

The name "Hyrel" heralds a complete new line of Sprague Capacitors conforming to the most rigorous set of capacitor specifications ever written. Techniques, materials, and processes combine to make it the most reliable paper capacitor possible within the present state of the art. After two years of exhaustive pilot runs, these high reliability units are in high volume production *now*.

In missiles, jets, warning networks, computers, controls . . . *wherever reliability is important* . . . Hyrel Q capacitors find scores of applications. A glance at Sprague Specification PV-100 tells you why. It's far above and beyond commercial or present MIL military levels . . . and it calls for outstanding performance under high *g* shock, vibration, humidity, immersion, as well as under accelerated life test. Complete facilities for making every test called for have been installed in a special plant area in which Hyrel Q capacitors are manufactured by specially selected personnel.

The first Hyrel Q capacitors—Type 195P—are subminiature metal-clad paper units hermetically sealed with *compression*-type glass-to-metal solder-seal terminals. Available in both conventional tubular and screw-neck mounting styles, all are Vitamin Q impregnated and designed for operation from -55°C to $+125^{\circ}\text{C}$. Voltage ratings of 200, 300, 400, and 600 VDC are standard.

Complete technical information is provided in Engineering Bulletin 2900 and Specification PV-100. Both are available on letterhead request to the Technical Literature Section, Sprague Electric Company, 35 Marshall St., North Adams, Mass.

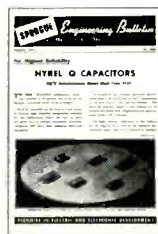

CAPACITORS • RESISTORS • MAGNETIC COMPONENTS • TRANSISTORS • INTERFERENCE FILTERS • HIGH TEMPERATURE MAGNET WIRE • PULSE NETWORKS • PRINTED CIRCUITS

SEE US AT THE I.R.E. SHOW—Booths 2416-18-20-22

hire 50 workers to reach its initial production goals. Workers were hired one at a time and trained in making the components. The firm found that by the time it had hired some 16 people, its production rate had been reached. Thus output per worker was three times higher than expected.

► **Markets**—Chief reason for the rise in magnistor sales and production is increasing applications in computers and in aircraft. One large manufacturer has built a computer that uses magnistors instead of tubes. Potter is manufacturing its flying typewriter utilizing the devices. Because prices of the units range between \$18 and \$25 the market is still limited. But the future outlook is bright and a drop in prices is foreseen as production grows.

► **Growth**—Electronics industry in Puerto Rico has grown from a few plants in 1950 to 44 at the start of 1957. Shipments to the U.S. have increased from under \$1 million six years ago to a record \$20 million in 1955-56. Under the islands complete freedom from Federal corporate taxes, electronics and electrical product manufacturers there earned a profit on sales of 33 percent net compared to a U.S. average of 5 percent.

Snark Finds Its Way With Gyros



Business-end of Air Force's Snark intercontinental missile which uses an inertial guidance system. In the 5,000-mile-range category, the missile has overall length of 69 feet



NINE HUNDRED pages of typing are eliminated at GE by 2,400 feet of magnetic tape as . . .

Magnetic Recording Adds Volume

Business increased about 20 percent in 1956. More foreign companies enter field

ALTHOUGH final official business statistics for the magnetic recording industry are not yet available, estimates from leading manufacturers in the field indicate that the industry scored a 20-percent gain in volume during 1956.

► **Volume**—An estimated 430,000 tape recorders were sold in 1956, a 20-percent increase over the 360,000 sold in 1955. This was nearly 200,000 more than the 235,000 reported sold in 1954 by Magnetic Recording Industry Association. The Census Bureau estimates that there were 274,000 tape recorders shipped in 1954 with a total value of \$25.7 million or an average value per unit of about \$94.

There are about 1.6 million tape recorders in use today, according to one leading manufacturer. The following breakdown shows the major markets: About 800,000 recorders are in use in the home, 160,000 in schools, 80,000 in churches and some 560,000 in business, studios, stations, agencies

and industry in general. Of the 1.6 million units in use, about 1.4 million are home-type machines and the remainder are professional units.

► **Tape**—Minnesota Mining and Manufacturing Co., which began making magnetic tape in 1947, estimates that total tape production for the industry in 1956 reached a value of \$10 million. This is nearly a \$2-million increase over 1955 volume of \$8.1 million and nearly \$3 million more than 1954 value of \$7.1 million. It also represents the largest yearly increase in tape production since the product has been on the market. For 1957, 3M expects tape production to increase 17 percent to a value of \$11.7 million.

The 3M figures on tape production are considered to be conservative. Census Bureau pegs the value of tape shipped in 1954 at \$8.3 million, about \$1.2 million higher than 3M estimates for '54.

► **Manufacturers** — Armour Research Foundation's licensing operations during 1956 indicate the changes that have taken place

(Continued on page 14)

Component Specification: ARNOLD

- ✓ SILECTRON CORES
Types C, E and O
- ✓ TOROIDAL CORES
Nylon and Aluminum cased
- ✓ BOBBIN CORES

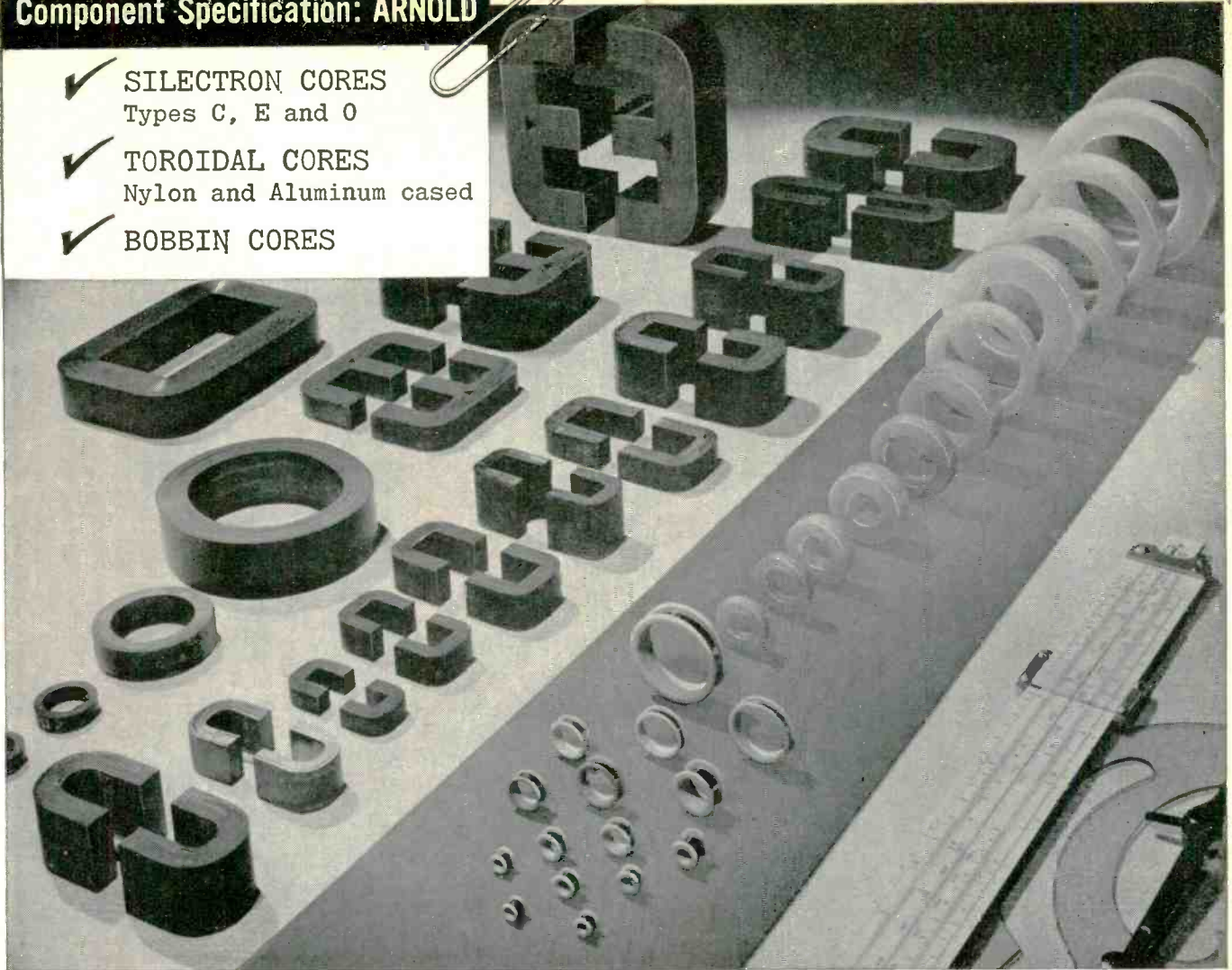

The ARNOLD LINE-UP includes ANY TAPE CORES you need

APPLICATIONS

We'll welcome your inquiries on your Tape Wound Core requirements for Pulse and Power Transformers, 3-Phase Transformers, Magnetic Amplifiers, Current Transformers, Wide-Band Transformers, Non-Linear Retard Coils, Reactors, Coincident Current Matrix Systems, Static Magnetic Memory Elements, Harmonic Generators, etc.

ENGINEERING DATA

For data on the various types of Arnold Tape Cores, write for these Bulletins:

SC-107—Silectron Cores, Types C, E and O

TC-101A—Toroidal Cores, nylon and aluminum cased

TC-108—Bobbin Cores

ADDRESS DEPT. E-73

How to be *sure* of tape core performance and uniformity? Just specify and use *Arnold* Cores in your transformer, magnetic amplifier, reactor and computer assemblies, etc.

Here's why!

To begin with, Arnold is a fully integrated company, controlling every manufacturing step from the raw material to the finished core. Then, modern testing equipment permits 100% inspection of cores before shipment. Finally, you're matching your requirements against the most experienced and complete line of tape cores in the industry. Arnold produces Types C, E and O Silectron cores,

nylon and aluminum cased toroidal cores, and bobbin cores to meet whatever your designs may require in tape thickness, material, core size or weight. Wide selections of cores are carried in stock as standard items for quick delivery: both for engineering prototypes to reduce the need for special designs, and for production-quantity shipments to meet your immediate requirements.

Let us help you solve your tape core problems. Check Arnold, too, for your needs in Mo-Permalloy or iron powder cores, and for cast or sintered permanent magnets made from Alnico or other materials.

WSW6447

THE ARNOLD ENGINEERING COMPANY



Main Office & Plant: Marengo, Illinois

Repat Pacific Division Plant: 641 East 61st Street, Los Angeles, Calif.

District Sales Offices:

New York: 350 Fifth Ave. Los Angeles: 3450 Wilshire Blvd. Boston: 200 Berkeley St.

among manufacturers in the tape recording field. Five new magnetic recording licenses were added during the year, according to Armour, bringing the total of participating companies to 66. There are 49 U. S. magnetic recording manufacturers and 17 foreign manufacturers. The new licensees are Telectro Industry, of Long Island City, N. Y. and EMI, Ltd., Collaro, Ltd., Simon Equipment, Ltd., and Tape Recorders, Ltd., all in Great Britain. Two U. S. licensees dropped out of the field in 1956.

During 1956, 11 new magnetic recording patents were issued in the U. S. and 17 in foreign countries. Five new applications for patents were filed domestically and four overseas, according to Armour.

New Batteries Bid For Electronics Market

Transistorized equipment along with new developments boost the market potential

THREE new batteries have been introduced in the past few months. National Carbon has a new 1.5-volt platinum-cobalt battery in the Hamilton electric wrist watch now on the market. Elgin National Watch and Walter Kidde Nuclear Labs developed a battery that uses the decay energy of a beta-emitting radioisotope as its source of energy. GE has a one-inch long battery in pilot production that is said to be 60 times stronger than the ordinary flashlight battery and to have a projected life of more than 20 years.

► **Applications**—The National Carbon battery is expected to have important applications in the hearing aid field. The Kidde-Elgin battery, although not yet commercially available, is expected to be used in transistorized portable radios and in civil defense warning receivers for the home. Use of the units for missile, rocket and deep space work is foreseen. The GE device is seen as a power source in remote fire and radiation warning devices, deep well



Atomic-powered battery, developed by Elgin Watch and Kidde Labs, can deliver usable current for five years

Military Electronics

► **Army** has set up a special agency to push development and production of electronic combat surveillance systems for use by battlefield commanders. The new unit is called Army Combat Surveillance Agency (ACSA) and will be headed by Brig. Gen. Francis F. Uhrhane, former Army Signal Corps r & d chief. Now being tested is a system using helicopter-borne tv gear

► **Six-million** dollar electronics plant is planned by Hughes Aircraft in California to produce components of ground radar systems for the Army, Navy and civil airways

► **Guided** missile instrumentation subcontract worth \$19.5 million has been awarded by Martin to Associated Missile Products of Pomona, Calif., subsidiary of AMF. The firm has leased 46,000 sq ft of space to handle the work

► **Plant** representing a \$50-million government investment has been operated in Kansas City for the past eight years by Bendix Aviation, the firm recently revealed. The operation is devoted exclusively to the atomic weapons program of the AEC under contract. The plant has a work force of 4,300 employees and occupies 1 million sq ft of floor space. It manufactures and assembles a wide variety of complex electronic, electromechanical and mechanical devices

► **Contract** totaling \$9.9 million has been awarded Collins Radio by Air Force for uhf ground communication equipment. Included in the order are over 1,500 units each of transmitters, receivers and modulator-power supplies, which make up the AN/GRC-27 radio set

survey equipment, and in transistorized instruments.

► **Market**—Importance of the electronics field as a market for battery makers shows in Department of Commerce figures. Hearing aids took over 40 million batteries in 1954 worth nearly \$10 million.

Battery shipments for portable radios totaled 12.4 million units in 1954 worth \$12.3 million. Farm radio battery shipments totaled 1.9 million units worth \$7.4 million. In the military field, dry-cell primary battery shipments were valued at \$32.8 million.

(Continued on page 16)

FROM START TO FINISH...WITH COMPLETE OR PARTIAL AUTOMATION

KÄHLE

MACHINES

FOR EVERY STEP OF DIODE MANUFACTURING

Manufacturers know there are no short cuts to diode quality. Each production phase is a vital one . . . because of this, Kahle designs these machines to account for and accurately control every possible factor . . . from the initial cutting of the glass tubing, to the growing of the Germanium or Silicon crystal, to the final sealing and testing of the diode.

Illustrated are a few of the intricate operations that can be accomplished with high speed Kahle Automatic Machines . . . because manufacturing needs vary so widely, Kahle's skilled engineers will develop individually "customized" machines or completely "automated" production lines to meet your specific requirements. 25 years' experience can help with your production problems.

Send for technical information about all Kahle Semiconductor Manufacturing Machines . . . please mention your applications or requirements.

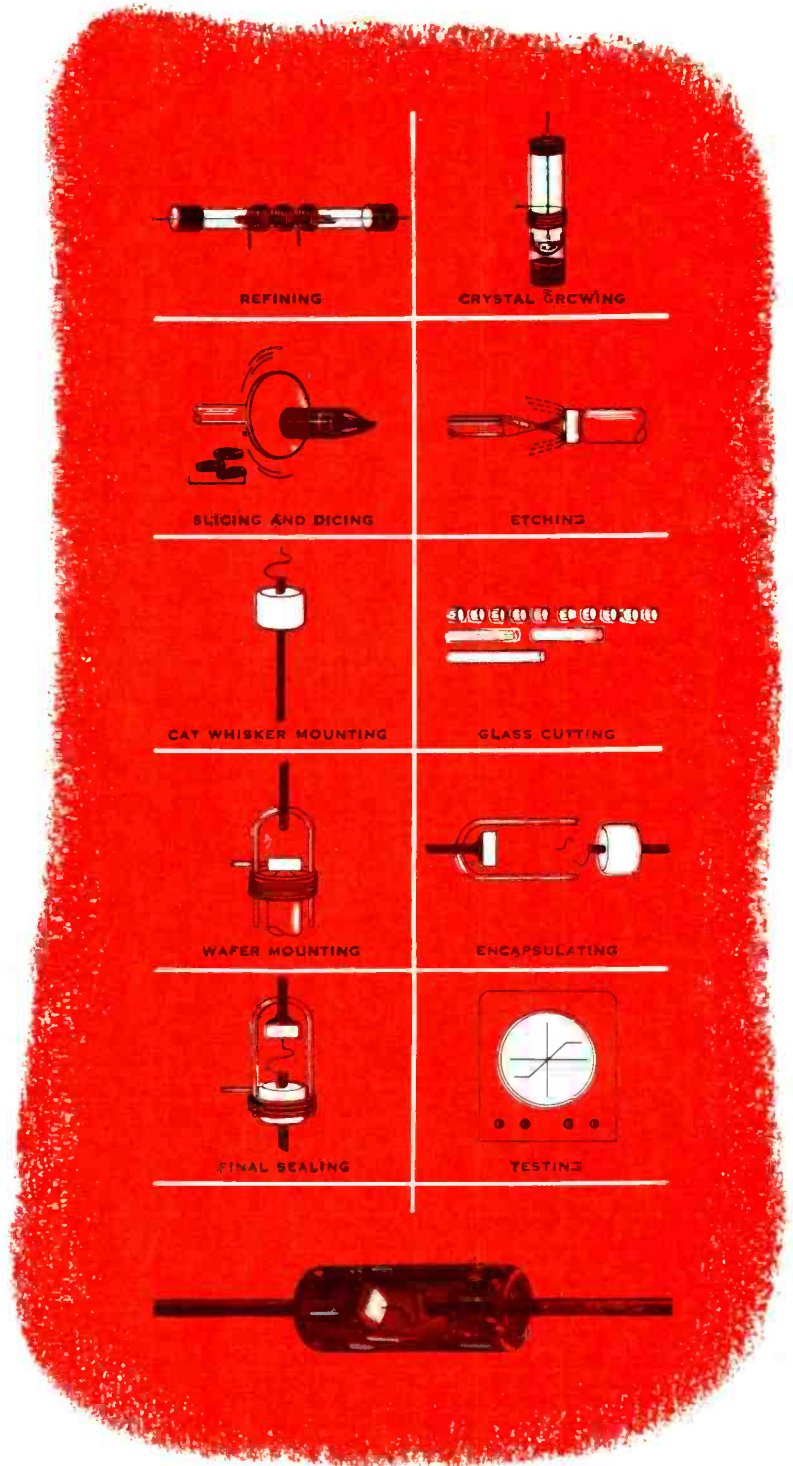

KÄHLE

ENGINEERING COMPANY

GENERAL OFFICES:
1310 SEVENTH STREET
NORTH BERGEN, N. J.

PLANTS:
SEVENTH STREET, NORTH BERGEN, N. J.
HUDSON AVE., UNION CITY, N. J.



NEW YORK'S giant new coliseum at Columbus Circle will house the latest in electronics as . . .

Industry's Biggest Convention Readies 1957 Program

More than 50,000 visitors are expected at the IRE show March 18-21 in Manhattan

COMPREHENSIVE program of fifty-five technical sessions at which over 150 technical papers will be delivered will be featured at the annual IRE show and convention to be held at the Waldorf-Astoria Hotel and at New York's new Coliseum.

All four floors of the Coliseum will be occupied by some 840 exhibitors of electronics products and by-products. Last year there were 714 exhibits.

► **Sessions**—Of the 55 technical sessions scheduled for this year's convention, 33 will be held at the Waldorf and 22 at the Coliseum. Two highlight sessions will cover the future use of air space and microminiaturization, both to be held March 19 in the evening. A list of scheduled technical papers and sessions begins on page 461 of this issue of *ELECTRONICS*.

► **Show** — Exhibits at the Radio Engineering Show have been grouped to save some time and wear on visitors. Computer and communications exhibits will be together on the first floor; component parts on the second, instruments, microwave and components on the third and production tools,

materials and services on the fourth floor.

► **Time**—Even with the convenient exhibit arrangement and new exhibit building this year, it will still be quite an endurance feat to cover the show. Spending just two minutes at each exhibitors display will consume nearly 30 hours or

about three days of the show leaving one day for attending technical sessions.

The annual meeting of the IRE will be held on the opening morning of the convention. Registration for the convention and show may be made at either the Waldorf or the Coliseum.

Electronics Output Paces Industry

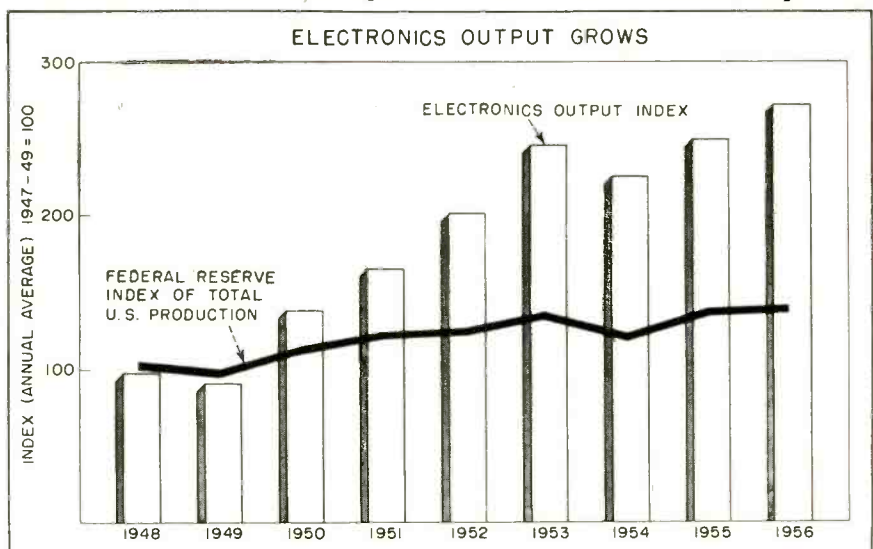

Growth has almost tripled since 1949 while total U.S. industrial output has risen 50 percent

THE electronics industry has been one of the fastest growing major industries in the U.S. Basis for

this is evident when the ELECTRONICS output index is compared to the Federal Reserve Board Industrial Production Index for U.S. industry as a whole. The industry has nearly tripled its business ac-

(Continued on page 20)



2-Year Warranty

We warrant that each new instrument sold by us is free from defects in material and workmanship and that properly used it will perform in full accordance with applicable specifications for a period of two years after original shipment. Any instrument or component that is found within the two-year period not to meet these standards after examination by our factory, district office, or authorized repair agency personnel will be repaired or, at our option, replaced without charge, except for tubes or batteries that have given normal service.

GENERAL RADIO Company
275 Massachusetts Avenue, Cambridge 39, Mass., U.S.A.

Inspected and Standardized by



Every
G-R Instrument
is Built to Last

It is the essence of G-R's design and manufacturing philosophy that every General Radio instrument shall be built to operate as reliably years later as it did upon first purchase by the customer.

This policy has built the reputation for

quality and long life which has come to be synonymous with the G-R trademark and now makes possible a *two-year warranty* to purchasers of G-R products. This warranty applies to all newly purchased General Radio products shipped after March 1, 1957.



General Radio Company

Since 1915, Manufacturers of Precision Electronic Equipment for Science and Industry

275 Massachusetts Avenue, Cambridge, Massachusetts
NEW YORK PHILADELPHIA WASHINGTON, D. C. CHICAGO LOS ANGELES SAN FRANCISCO

FOR GUIDED MISSILES...



ANNOUNCES A NEW LINE
OF SUBMINIATURE TUBES



WITH **RELIABILITY +**

Here are some of the features of this line of RAYTHEON RELIABILITY + SUBMINIATURE TUBES:

- Reduced vibration output after shock
- Increased clearance between elements
- Controlled operation time
- Tighter limits for important characteristics
- Greater uniformity
- Lower microphonics
- Better resistance to shock and fatigue
- Pulse emission specification (where applicable)

ASSEMBLED UNDER GLASS

Raytheon RELIABILITY + Subminiature Tubes are made and assembled under glass in air conditioned, lint-free and dust-proof quality controlled areas. Every detail of construction is subject to the most advanced mechanical techniques including semi-automatic jigs and fixtures so that operator skill is no longer the critical factor. That's why these Raytheon Subminiature Tubes provide *Reliability Plus* performance.

RAYTHEON RELIABLE SUBMINIATURE TUBES For Guided Missile, Military and All Other Critical Applications
TYPICAL CHARACTERISTICS

TYPE	DESCRIPTION	Vibration Output* (maximum) mVac	Vibration Output** (peak to peak) mV	Heater Volts mA		Plate Volts mA		Cathode Bias Resistor ohms	Screen Volts mA		Amplification Factor	Mutual Conductance μ mhos
CK5702WB	Video Amplifier, Pentode	50	240	6.3	200	120	7.5	200	120	2.6	—	5000
CK5703WB	High Frequency Triode	10	50	6.3	200	120	9.4	220	—	—	25.5	5000
CK5704†	High Frequency Diode	—	25	6.3	150	Max. inverse peak = 460 volts; max. I_b = 10 mA						
CK5744WB	High Mu Triode	15	75	6.3	200	250	4.2	500	—	—	70	4000
CK5783WB	Voltage Reference	50	—	Operating voltage approximately 85 volts between 1.5 and 3.5 mA								
CK5784WB	RF Mixer Pentode	75	300	6.3	200	120	5.5	230	120	4.1	—	3200
CK5787WB	Voltage Regulator	50	—	Operating voltage approximately 98 volts between 5 and 25 mA								
CK6247WA	Low Microphonic	2.5	25	6.3	200	250	4.2	500	—	—	60	2650
CK6533WA	Low Microphonic Triode	1.0	—	6.3	200	120	0.9	1500	—	—	54	1750

Each type is electrically and mechanically interchangeable with earlier versions of the same basic type. Developed under Navy sponsorship.

Bulb temperature ratings to 265°C.

†Type number for improved CK5704 not assigned.

*15g, 40 cps, fixed frequency
**15g, 30 to 1000 cps sweep



SPECIAL TUBE DIVISION

RELIABLE MINIATURE AND SUBMINIATURE TUBES • VOLTAGE REFERENCE TUBES
VOLTAGE REGULATOR TUBES • PENCIL TUBES • NUCLEONIC TUBES

NEWTON, MASS.: 55 Chapel St. • B1gelow 4-7500
NEW YORK: 589 Fifth Ave. • PLaza 9-3900
CHICAGO: 9501 Grand Ave., Franklin Park • TUxedo 9-5400
LOS ANGELES: 5236 Santa Monica Blvd. • NOrmandy 5-4221

VISIT RAYTHEON BOOTHS 2611-12-13-14, I.R.E. SHOW, N.Y.C.

Now! 7/16" STUD type as well as WIRE-IN type

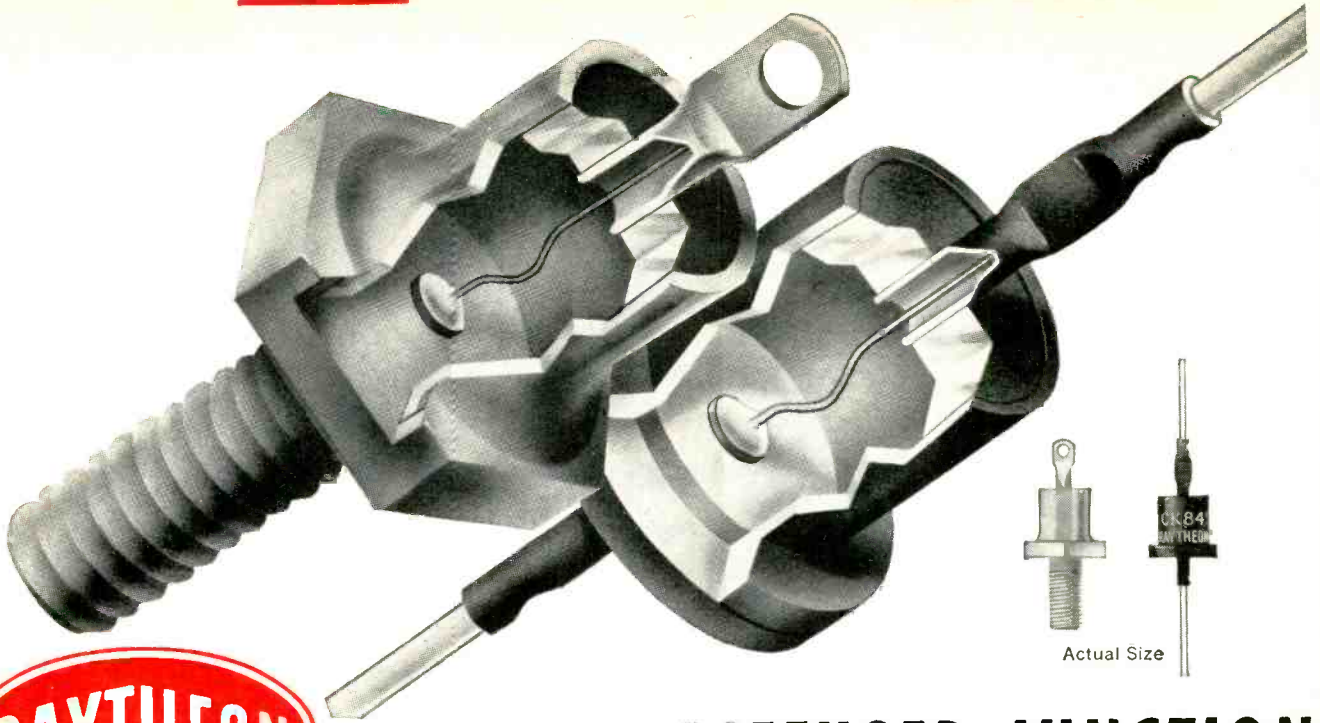

SOLID STATE DIFFUSED JUNCTION

SILICON RECTIFIERS

AVERAGE CHARACTERISTICS				Case Dimensions***		
Type	Peak Inverse Volts*	Forward Current** Amps. 150°C Case Temp.	Reverse Current (max.) at PIV mAdc at 25°C			
CK846	100	1.0	0.002			
CK847	200	1.0	0.002			
CK848	300	1.0	0.002			
CK849	400	1.0	0.002			
CK850	500	1.0	0.002			
CK851	600	1.0	0.002			
Type	Peak Inverse Volts*	Forward Current** Amps. 150°C Ambient	Amps. 100°C Ambient	Reverse Current (max.) at PIV mAdc at 25°C		
CK840 (1N537)	100	0.25	0.5	0.002		
CK841 (1N538)	200	0.25	0.5	0.002		
CK842 (1N539)	300	0.25	0.5	0.002		
CK843 (1N540)	400	0.25	0.5	0.002		
CK844	500	0.25	0.5	0.002		
CK845	600	0.25	0.5	0.002		

Operating Temperature—minus 65°C to plus 165°C

Storage Temperature — up to 175°C

Hermetically Sealed—Welded

Precise Junction Gradient for Specific Rectifier Applications

Flat Junctions for Uniformity and Control of Characteristics

Uniform characteristics and uniformly high quality are assured by the Raytheon Solid State Diffusion Process which permits flat junctions and provides exact control of junction penetration.

Now, you can have your choice of ratings in either stud or lead construction, and both are available in production quantities.

*PIV ratings apply from -65°C to +150°C
 **Average rectified current into inductive or resistive load
 ***All dimensions maximum except where noted



SEMICONDUCTOR DIVISION

Silicon and Germanium Diodes and Transistors • Silicon Rectifiers

NEWTON, MASS.: 150 California St. • DEatur 2-7177
 NEW YORK: 589 Fifth Ave. • PLaza 9-3900
 CHICAGO: 9501 Grand Ave., Franklin Park • TUXedo 9-5400
 LOS ANGELES: 5236 Santa Monica Blvd. • NORmandy 5-4221

VISIT RAYTHEON BOOTHS 2611-12-13-14, I.R.E. SHOW, N.Y.C.

tivity over that in the 1947-49 period while total U.S. industry increased its output 50 percent.

► **Rank**—A look at the FRB indexes of individual industries shows there are only a handful that have even doubled in activity since the 1947-49 base period and only one that exceeds electronics industry growth. They are specifically: electrical machinery,

which includes electronics, 212; aluminum, 269; aluminum mill shapes, 220; heavy trucks, 201; aircraft and parts, 578; concrete and plaster products, 206; mill-work and plywood, 200; synthetic rubber, 241; and canned and frozen foods, 247. Only aircraft outranks the electronics industry in rate of growth among the major industries covered by FRB indexes.



CHASSIS will be installed in portable tv sets at RCA's plant as . . .

Small Sets Do Big Business

Manufacturers say portable tv sets are still gaining and may hit 3 million in 1957

ALTHOUGH television set manufacturers do not like the low profit margins that come with portable tv sales they are impressed by the high unit volume record the sets have made and seem likely to surpass in 1957.

RETMA says that the portable tv set has been an outstanding success with about 1.5 million produced in 1956. It estimates that 3 million may be produced in 1957.

Here's how individual manufacturers look at the portable tv business:

► **Admiral**—Estimates that tv output of the entire industry might reach a record 9 million units in 1957 with nearly half in 10, 14 and 17-inch portable models.

► **Motorola**—Plans to emphasize

portables more so in 1957 than it did in 1956. It expects that portables will account for 2.5 million of a 6.8 million total tv volume in 1957.

► **Philco**—Says that units will have increasing popularity in 1957 following the trend toward second sets in the home. It expects the big volume of sales will be in lower priced receivers on which there is a small margin of profit.

► **Sylvania**—Sees the portable tv picture as similar to a period that the radio industry passed through 20 years ago when the public stopped buying consoles and began buying table models that were less expensive and carried a shorter margin of profit. The company sees more than 6.9 million sets sold to the public in 1957 with portables accounting for up to 40 percent of the total. In 1955 portable sales accounted for less than 4 per-

cent of all tv sales. In 1956 it jumped to 20 percent and in the final quarter had risen to 51 percent of distributor sales to dealers. The trend in portables is expected to get a boost during 1957 through the new 110-degree picture tube sets, according to the company.

Experimental Radio Service Expands

Activity in the field reaches new high with yearly applications exceeding 1,500

GROWING amount of research and development work being carried on by the electronics industry is partially reflected in the increased activity of the experimental radio service.

Today there are over 750 experimental stations licensed. Annual number of applications handled has climbed from less than 1,000 in fiscal 1952 to over 1,500 in fiscal 1956. This is the best measure of activity since a separate license is required for each experimental project and the license is cancelled when the project is completed.

► **Kinds**—The experimental radio service provides for four classes of stations: research, developmental, export and contract. Research stations are used for basic research in radio such as investigations of propagation, exploration of the various ionized layers in the ionosphere, studies of tropospheric effects and research in new circuitry and modulation techniques.

Developmental stations cover development of new radio services, new techniques and procedures in existing services. Export stations are used to test equipment for overseas markets and contract stations are those used for contract work for the government, much of which is classified.

► **Techniques**—Most present experimental stations are operated in behalf of contract work

(Continued on page 22)

"FOR MAXIMUM KILL-PROBABILITY"

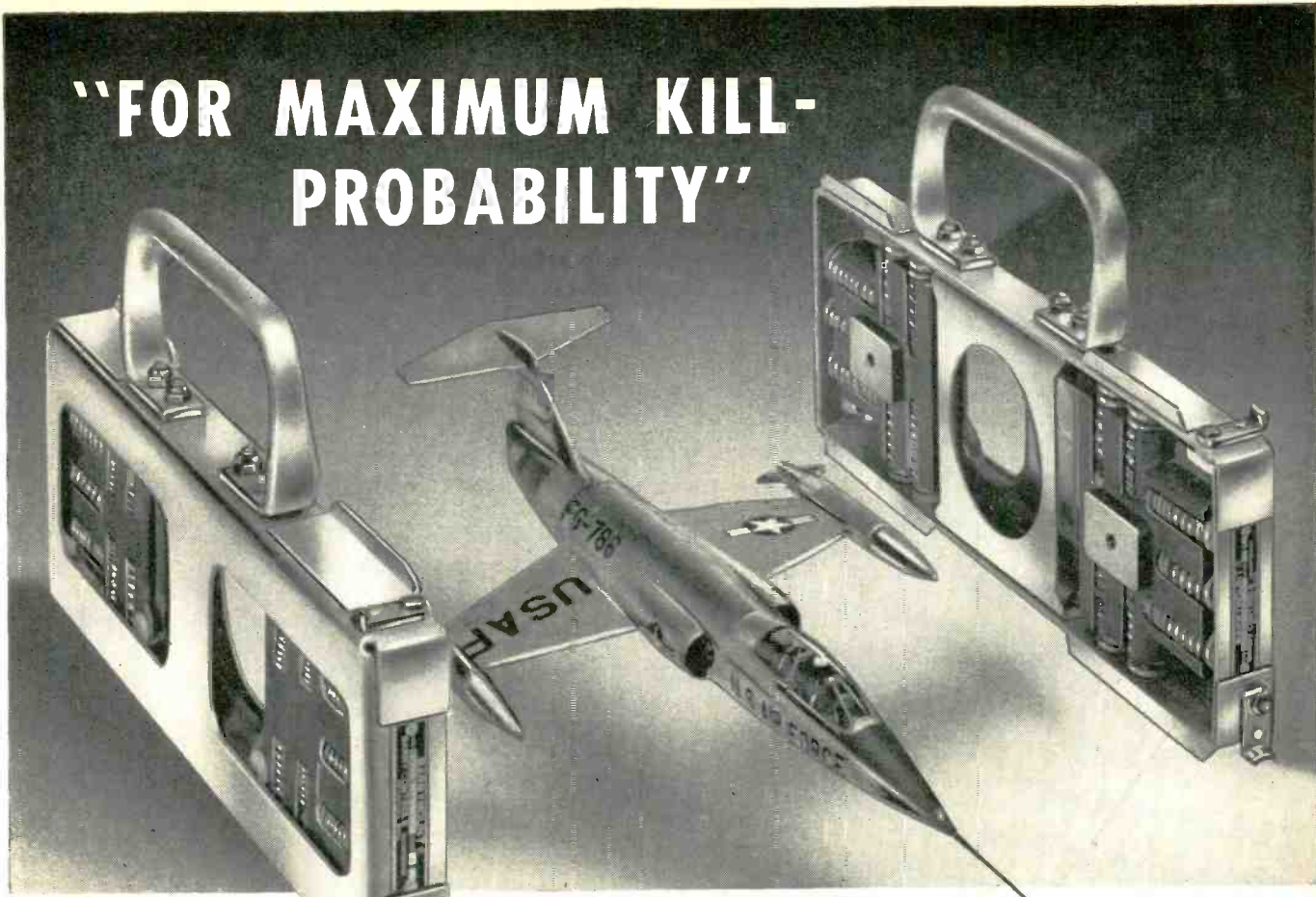

See All-Angl demonstration Booth 2534, I.R.E. Show

Starfighters' Fire-control Radars Use Barry's NEW Integral* Mounting Systems

In the most advanced airplane of its type ever developed — Lockheed's F-104A Starfighter — Barry's new Integral* Mounting Systems are solving the toughest combination of shock, vibration, and sustained-acceleration problems ever posed by jet aircraft. Literally a "missile with a man in it", the F-104A demands that equipment mounts give superior performance, in less space, and at lighter weight than ever before.

Here's how Barry's Integral* Mounting Systems are meeting this demand in the production models of the Starfighter.

In a space only $12\frac{3}{4} \times 5\frac{3}{8} \times 1-13/32$ " on each side of a 150-pound load . . . a pair of units weighing less than three pounds each . . . provides adequate vibration isolation at 4g sustained acceleration in all radial directions . . . passes all shock-test requirements of this supersonic fighter . . . performs reliably through wide temperature and altitude ranges . . . and provides positive, quick-release attachment to the airframe to satisfy Lockheed's requirements for "plug-in" electronics-system components.

Here's the way this system works.

Helical springs designed to function in their axial direction only are grouped about the load attachment points so as to provide controlled resistance to movement along the *a* and *b* axes. For the *c* axis, resistance is provided by the slightly tapered side flanges of the mounting frame working against the displacement of all the load-carrying springs.

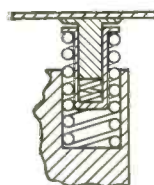
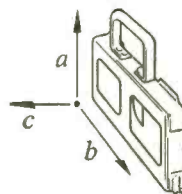

Damping adjustments (see diagram), completely independent of the stiffness of the load-carrying springs, provide design flexibility for obtaining desired natural frequency, transmissibility at resonance, and degree of vibration and shock isolation.

Write for THO-5 containing a full exposition of this All-Angl Integral* Mounting System.



BARRY CONTROLS

INCORPORATED

BARRY B MOUNT

SALES REPRESENTATIVES
IN ALL PRINCIPAL CITIES

707 PLEASANT STREET,

WATERTOWN 72, MASSACHUSETTS

*Integral means . . .

Designed specifically for the environment performance requirements. Built specifically for the equipment. You can save time, space, and trouble by bringing your shock and vibration problems to us. Call your Barry sales representative.

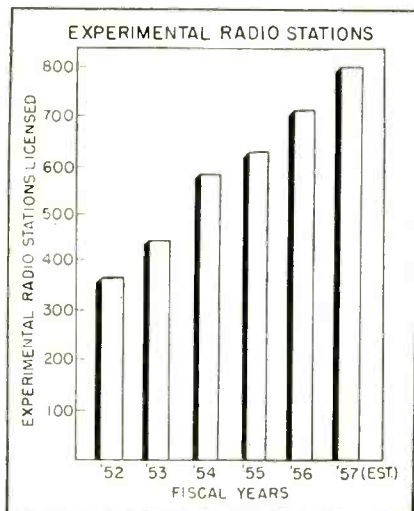

for Federal agencies, chiefly the Department of Defense. Stations operated by manufacturers and developmental labs are engaged primarily in development of new radio and electronic techniques.

Narrow band, split-channel communication is receiving increased attention, according to FCC. New aids to navigation are being developed, including high-definition radar sets as well as lightweight radar equipments. Broad-band multiple-channel microwave experimentation as well as ionospheric scatter tests are receiving greater attention from both civilian and military research development groups.

Among the organizations presently most active in the experimental radio field are RCA, GE, Bell Labs and Harvard University.

Some organizations have over 100 experimental station authorizations, according to FCC frequency assignments.

► **Problems**—Practically all usable frequency bands in the spectrum have been allocated to the regular radio services, according to FCC, and it is necessary to borrow frequencies from these services for experimentation. The difficulties of doing this have compelled the Commission to restudy its allocation policy and the frequency assignment procedures for the experimental radio services.

FCC Actions

- **Amended** motor carrier rules to permit 45-mc communications during local pickup and delivery by vehicles engaged in interurban transport
- **Clarified** requirements for filing data on allocations above 890 mc. Only those not intending to present oral testimony are bound by Feb. 4 deadline
- **Postponed** for six months the requirements concerning radiation interference above 260 mc for uhf-tv receivers on request of RETMA
- **Received** petition to amend rules looking towards allocation of new channels to reduce separations between frequencies in the 152-162 mc band
- **Scheduled** hearing on continued use of 6-mc for ship-shore public telephone on the Mississippi River system
- **Studied** request for changes in regulations concerning remote control of objects by radio—including the 27 and 460-mc regions

Computer Centers Increase Fast

Number of centers has tripled since 1954. Many foreign centers are scheduled

PLANS by Electronic Associates to establish an analog computer center in Brussels, Belgium by next July emphasizes the rapid growth of computer centers at home and abroad.

Today there are about 10 commercial computer centers abroad and about 50 in the U.S. In 1954 there were about 20 centers worldwide. In the past month, plans for 14 new centers were announced.

► **Why**—The centers have proved valuable to U.S. and European industry and to computer manufacturers themselves. Electronic Associates says that there is still a growing need in industry for a facility such as it will establish in Brussels. One purpose of the

centers is to educate business and industry on the capability of computers to economically solve many of their problems with a substantial saving of time and money.

► **Growth**—Increasing importance of computer centers to computer manufacturers is also indicated by the expanding operations of IBM. The company recently set up The Service Bureau Corp., a subsidiary, which operates the firm's 15 computer centers in the U.S. The IBM World Trade Corp. another subsidiary, has computer centers operating in Paris, Stuttgart, London and Toronto. A center in Caracas, Venezuela opened in February.

In the next two years, IBM data processing centers are scheduled to begin operation in eleven other cities outside the U.S.

(Continued on page 24)

ENVIRONMENTAL TEST CHAMBERS

AIRECO, INC. are designers and builders of standard and custom-built environmental testing equipment for maintaining thermo, sub-zero and stratosphere conditions. Each is individually designed for its specific purposes and will produce and maintain temperatures from

-150F to +750F, altitudes from sea level to 150,000 feet and humidity from 10 to 95%. Known the world over, you can rely on AIRECO, INC. service guaranteed test chambers.

CUSTOM BUILT FOR GE

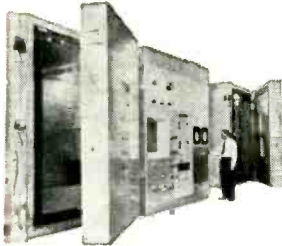

This custom built environmental test chamber was one of seven built for the General Electric Company, French Road Plant, Utica, New York. AIRECO, INC. in conjunction with the development engineers of G. E. decided on design temperatures of -100F to +250F; humidity from 20 to 95% and altitudes varying from sea level to 150,000 feet. This design assured long usage in the face of ever changing MIL specifications. Pull down is from ambient to -100F in 1 1/2 hours with 1500 lbs. mass load and 5 kw heat dissipation. The chambers were to hold -100F at 100,000 feet with a 5 kw heat dissipation load at all times; reach 250F from room ambient with the same mass load in 1 hour; maintain the desired humidity range from 33F to 250F; perform any one of these requirements for a period of 320 consecutive hours. Want more information?

TESTS TAIL GUN TURRETS

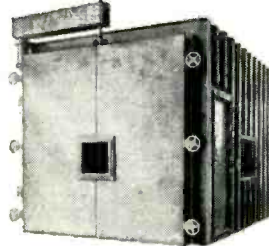

This environmental chamber is one of the largest of its kind in the country and was designed and constructed for the General Electric Company for the testing of complete jet bomber tail gun turrets under all conditions of temperature, humidity and altitude. The size of this chamber is 15' x 15' x 25'. The exterior pressure shell was designed to withstand 15 psi for simulated altitude conditions to 150,000 ft. The equipment door is opened, closed and locked by means of a high pressure hydraulic system. Chambers of this type are constructed on job because of their immense size and weight. The temperature range is -100F to +250F; with a cooling capacity from ambient to -65F in 1 hr.; humidity range, 20 to 95% relative, altitude to 150,000 ft.

FOR TESTING GAS TURBINE STARTERS

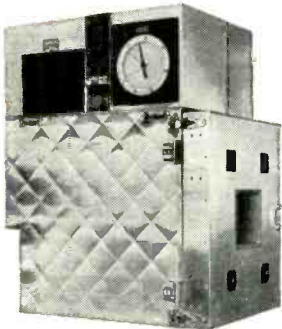

Custom front opening cabinet completely portable for the testing of gas turbine starters under varying temperature conditions for the Bendix Aviation Corp. This cabinet has all its refrigeration equipment mounted on top to allow the working area to be as close to the floor as possible. The temperature range is -85F to +200F, with a cooling capacity from ambient to -85F. in 3 hours. For normal operation the door is removed and a stationary bulkhead is used in its place for the mounting of the jet starter. The cabinet is then moved into position and clamped to the bulkhead. The equipment is then cooled or heated and the box is moved away for the starter to be fired.

IDEAL FOR ELECTRONIC COMPONENTS

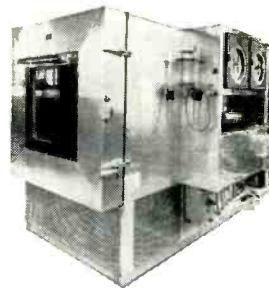

Standard front opening environmental chamber for testing electronic components and equipment under all conditions of temperature, humidity and altitude. This cabinet was originally manufactured for the General Electric Company. The working space is 27 cubic feet. The temperature range is -100F to +300F; humidity range from 20 to 95% relative; altitude to 150,000 ft; with a cooling capacity from ambient to -100F in 3 hours. This cabinet has wide applications throughout the electronic industry for either military, commercial or laboratory uses. Perhaps, you are interested in a larger or smaller capacity in this design, if so, please communicate directly with Aireco Inc at the address below.

COMPLETE OUTDOOR ALL WEATHER TESTING

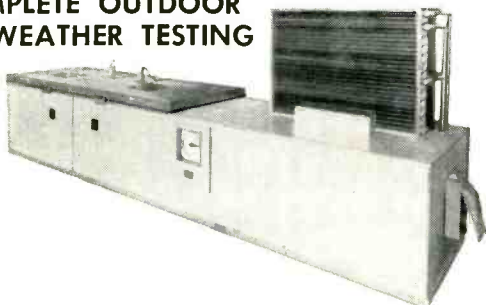

This lift lid type cabinet was specially designed and constructed for the U. S. Navy for the testing of rockets at -100F. It has a 75 cubic foot capacity and was completely constructed on both the inside and outside of stainless steel for operation in an outdoor location continuously exposed to the various elements. The refrigeration system was designed for year round operation under all weather conditions without the use of water. The temperature range is from -100F to +200F with a cooling capacity from ambient to -100F in 4 hours with full load.

FOR ELECTRONIC COMPONENTS AND EQUIPMENT

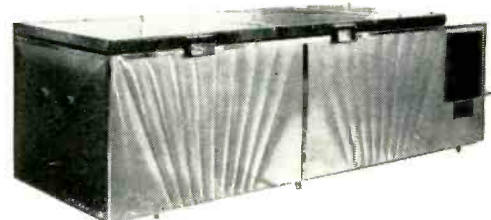

This standard lift lid type cabinet is for the testing of electronic components under all temperature conditions from -100 to +200F. Working space of 50 cubic feet with stainless steel interior. Cover is operated hydraulically. The temperature range is -100F to +225F, with a cooling capacity of ambient to -100F in 3 hours.

All types of testing equipment for lease. Contact us for particulars.



ENGINEERED ENVIRONMENTAL EQUIPMENT FOR RESEARCH AND TESTING
2323 SECOND AVENUE, CARMAN
SCHENECTADY 3, NEW YORK

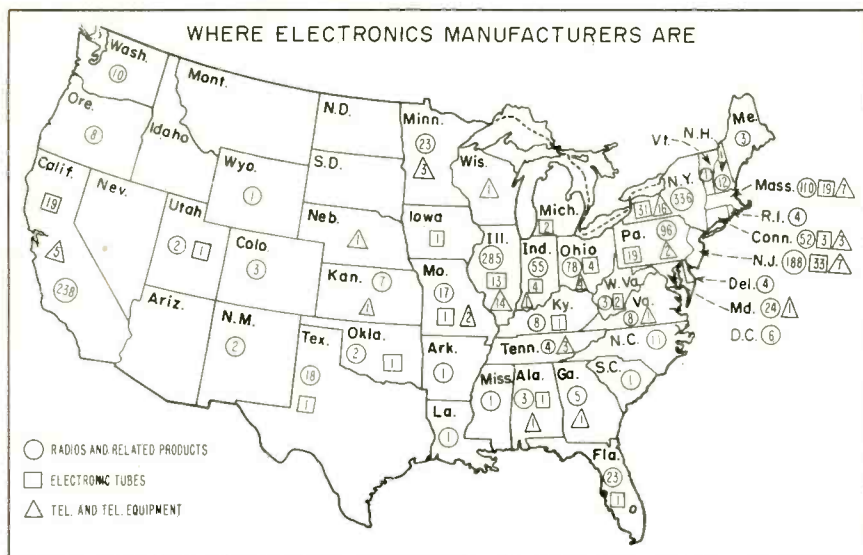

Magnetron Research Improves Cohos

New amplifier increases efficiency, aids in avoiding radar interference

A HIGH-POWERED broadband microwave amplifier has resulted from research by Raytheon on magnetrons. Called the amplatron, the new tube provides 800-kw peak power output and has a pass band of about 10 percent. It is said to have efficiencies of 50 to 70 percent.

► **Need**—Coherent moving-target indicating systems (cohos) require that there be no change in phase from one radar pulse to the next. The output of a continuously operating oscillator such as a klystron can drive the amplatron, which in turn radiates a pulse. The phase of the echo is remembered and compared with the phase of future echoes. If there is a difference, the target from which the echo is received is moving.

► **Interference**—The amplatron is also helpful in avoiding radar interference. Because it will amplify a broad band of frequencies without mechanical or electrical adjustments, the frequency of an oscillator operating into the amplatron can be changed quickly to a frequency where less interference is encountered.

Electronics Sinks New Roots

Six states continue to hold the bulk of the industry but new areas grow

ADVANCE report by the U. S. Census bureau gives the latest authoritative picture of where electronics manufacturers are located in the U. S. It shows that six states, long-term centers for electronics, maintain their positions as of 1954, latest Census figures.

► **Big Six**—As indicated on the map, New York, California, Illinois, New Jersey, Massachusetts and Pennsylvania lead in the number of manufacturers of radios and related products. They also lead in number of tube manufacturers and telephone and telegraph firms.

Importance of these six key states in the industry is indicated by the number of workers employed. Together, they employ some 207,000, about 70 percent of the 293,998 employees in radios and related products.

In electronic tube manufacturing, the six states account for about 53,000 of the tube industry's 71,000 employees or 74 percent. Of telephone and telegraph firms, about 57,000 employees out of 65,000 total, or 87 percent, are in these states.

► **Change**—Growth of the electronics industry, even since 1954, is changing its direction somewhat.

For some states the change has been drastic.

In Arizona, the map shows not one company classified by Census in the electronics field in 1954. Today there are ten major electronics firms in the state and a score of smaller subcontractors. Much of the growth has been due to the establishment of Ft. Huachuca Army Electronics Proving Ground.

Special weapons research centers in New Mexico are fostering the development of a small but growing electronics industry. The map shows that there were only 2 firms there classified as electronic. Today there are over a dozen.

Financial Roundup

DOZEN manufacturers in the electronics field that reported in the past month on net profits showed mixed results for the fiscal periods indicated. Here are the results for the 12 companies covered:

Company	1956	Net Profit	1955
ACF Industries 6m	\$3,758,407		\$3,874,775
American Elect. 9m	242,425		177,377
Bendix Aviation 12m	24,278,263		25,888,599
Cook Electric 6m	370,032		*50,840
Daystrom 9m	1,838,000		1,295,000
Emerson Radio 12m	84,852		2,468,063
General Instrument 9m	337,146		241,994
National Research 12m	130,000		*337,000
ORRadio Industries 9m	85,986		64,293
Topp Industries 9m	90,000		
Packard-Bell 3m	259,950		
Varian 3m	226,000		80,000
* (loss)			



Testing new microwave amplifier tube
(Continued on page 26)

NOW...A MORE COMPACT 28 VOLT, 100 AMPERE tubeless magnetic amplifier regulated DC POWER SUPPLY

by **PERKIN!**

24 to 32 Volts Adjustable Range...
IMMEDIATE DELIVERY!

This power supply represents the latest design thinking of the nation's top specialists in the field. Hundreds of these units are now in operation, replacing generators and batteries in electronic laboratories, industrial plants, and military ground radar systems, etc., where utmost reliability and performance are essential. Over 15,000 Perkin power supply units are in operation in industry today.

No tubes, moving parts or vibrating contacts.

Regulation $\pm 1/2\%$

IMMEDIATE DELIVERY!

DIMENSIONS:
26 1/2" L x 17" D
x 17" H.

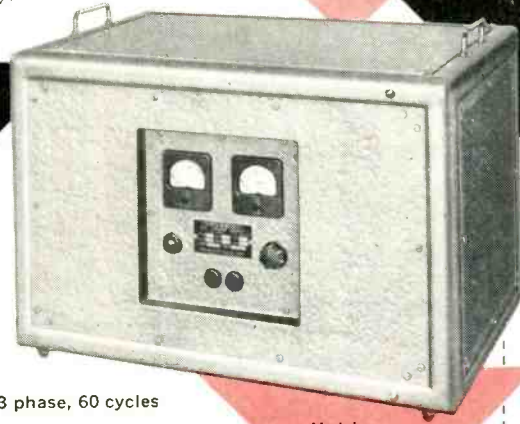

Model MR2432-100XA

Additional Specifications:

- Ripple: 1% RMS
- AC Input: 208, 230 or 460V $\pm 10\%$, 3 phase, 60 cycles
- Weight: 230 lbs.
- MODEL NO. MR917-100XA — also available: specifications same as above except output of 9 — 17 volts DC.

When you require a power supply, SPECIFY PERKIN, for a wider range of standard models and immediate delivery from stock.

Wire factory collect for prices. For a prompt reply on your application, write factory on your letterhead or contact local representatives listed below.

PERKIN

PERKIN ENGINEERING CORPORATION
345 KANSAS STREET, EL SEGUNDO, CALIFORNIA • OREGON 8-7215

Leader in Tubeless Magnetic Amplifier Regulation

New York Area: Sales and Warehousing: 1060 Broad St., Newark 2, N.J., Market 3-1454

SALES OFFICES: Chicago: PA 5-6824 • Philadelphia: BR 5-2600 • Boston: MI 8-0756 • Albuquerque: 5-9632
Atlanta: EL 3020 • Charlotte: ED 2-7356 • Dallas: FO 8-8306 • Denver: MA 3-0343 • Kansas City, Mo.: VA 1-5330 • Miami: MO 5-1563 • Minneapolis: MI 4-7884 • Seattle: MO 4895 • St. Louis: PA 5-7701
Winston-Salem: 4-9750 • Canada: Agincourt, Ontario: AX 3-7011.

OTHER PERKIN STANDARD DC POWER SUPPLIES

28 Volt Models

Model	Volts	Amps	Reg.	AC Input (60 cps)	Ripple rms
28-5VFM	0-32 V	5	15-20% (24-32V range)	115 V 1 phase	2%
28-10WX	24-32 V	10	$\pm 1/2\%$	100-125 V 1 phase	1%
MR532-15A	2-36V	15	$\pm 1/2\%$	105-125V 1 phase	1%
28-15VFM	0-32 V	15	15-20% (24-32V range)	115 V 1 phase	5%
M60V	0-32V	25	$\pm 1\%$	115V 1 phase	1%
MR1040-30A	5-40V	30	$\pm 1\%$	100-130V 1 phase	1%
28-30WXM	24-32V	30	$\pm 1/2\%$	100-125V 1 phase	1%
28-50WX	24-32 V $\pm 10\%$	50	$\pm 1/2\%$	230 V* 3 phase	1%
MR2432-100XA	24-32V	100	$\pm 1/2\%$	208/230V* 3 phase	1%
MR2432-200	24-32 V	200	$\pm 1/2\%$	208/230V* 3 phase	1%
MR2432-300	24-32 V	300	$\pm 1/2\%$	208/230V* 3 phase	1%
MR2432-500	24-32 V	500	$\pm 1/2\%$	208/230V* 3 phase	1%

* $\pm 10\%$. Also available in 460 V $\pm 10\%$ AC input. Will be supplied with 230 V input unless otherwise specified.

6, 12, 115 Volt Models

Model	Volts	Amps	Reg.	AC Input (60 cps)	Ripple rms				
6 Volt	6	5	$\pm 1\%$	95-130 V 1 phase	1%				
	6-5WX $\pm 10\%$								
	6-15WX $\pm 10\%$								
12 Volt	6	40	$\pm 1\%$	95-130 V 1 phase	1%				
	6-40WX $\pm 10\%$								
115 Volt	12	15	$\pm 1\%$	95-130 V 1 phase	1%				
	12-15WX $\pm 10\%$								
	115					5	$\pm 1/2\%$	95-130 V 1 phase	1%
	115-5WX $\pm 10\%$								
MR15125-5	15-125	5	$\pm 1\% \dagger$	95-130 V 1 phase	1% ††				
G125-25**	115-125	25	$\pm 1 1/2-4\%$	230/460 V 3 phase	5%				

**Germanium Rectifier Unit ††Increases to 4% @ 15V. †Increases to 2% @ 15V.



Radar-Computer Finds Mortars

Enables counter-fire within seconds. Set up from trailers in from 10 to 15 minutes

ARMY Signal Corps and GE have added an improved electronic computer to a modified version of the mobile radar equipment used in the Korean fighting for locating enemy mortars. Enemy position can be pinpointed in seconds.

GE will begin an accelerated manufacturing program to produce the first production models early this year. Completion of the order is expected by March, 1958.



Radar picks up enemy mortar shell in flight, computer determines location of mortar. New equipment is more compact and accurate than gear used in Korea

► **How** — Trajectory of enemy's mortar shell passing through the radar beam is registered by blips on the operator's indicator screen. Cross hairs lined up on the blips provide a direct map coordinate reading of the source of fire. Relayed to an artillery battery, this information triggers immediate counterattack.

Transportable on two small trailers, the equipment, known as AN/MPQ-4, can be set up in 10 to 15 minutes. It can be controlled in the trailer or from a remote position.

Impact point of the Army's own mortar shells can be read from the equipment for correcting fire direction.



INSPECTOR checks monochrome picture tubes at RCA plant as . . .

Envelope Sales Keep Growing

High volume of tube sales in 1956 meant more business for bulb companies

MORE tv picture tubes were sold by tube makers in 1956 than in any previous year. Cumulative picture tube sales for 1956 totaled 10.9 million units valued at \$196.2 million compared to 10.8 million units valued at \$209 million in 1955.

The number of receiving tubes produced by the industry last year was exceeded only by record sales in 1955. Receiving tube sales totaled 464.1 million units valued at \$374.1 million in 1956, compared to 479.8 million units valued at \$358.1 million in 1955.

► **Sales**—General Electric has estimated that about 14 million tv picture tubes will be sold in 1957. Of these, 6.8 million will be for replacement. It also estimates that receiving tube volume will reach \$400 million in 1957.

At an average tv bulb price of about \$8, next year's sales in picture tubes could mean a dollar volume of \$112 million for envelope makers. However, glass companies may never sell that much because tube rebuilders will take a sizable share of the market.

One glass maker estimates that the rebuilt tube business now runs at an annual volume of some 5 million units, half of the business accounted for by legitimate tube manufacturers and the other half by fringe operators that may not label the tubes as rebuilds.

► **Color**—One of the new developments that may boost glass envelope sales substantially in 1957 is RCA's recent adoption of an all-glass envelope for its color tv picture tube. It has used a metal envelope manufactured by I-T-E Circuit Breaker in Philadelphia.

RCA plans to produce the new tube about midyear. The envelope and a new technique of glass sealing were developed by glass manufacturers working with the company. Price of the new tube will be comparable to the present metal envelope type. The problem of sealing the faceplate and funnel in the all-glass tube was solved through use of a glass flux that initially melts at relatively low temperature but thereafter almost assumes the qualities of the original glass bulb.

► **Deflection**—Envelope makers are moving into the 110-degree deflection tube field fast. An increasing

(Continued on page 28)

DO YOU KNOW

... transistors can be 20-30 db less noisy than low noise vacuum tubes?

These two companies use the new "hushed transistor" circuit in their most sensitive instruments.



SENSITIVE
AC & DC
VOLTMETERS
LOW NOISE
LOW DRIFT
10 μ V
FULL SCALE

Type MV - 45A
TRANSISTOR
VOLTMETER
Range:
2 μ V to 1 kV
2 cps to 150 KC

"Hushed Transistors" (having zero or reversed collector junction voltage) exhibit noise voltages, referred to their shorted input terminals, which are at least 20 db lower than the noise voltages of the finest low-noise vacuum tubes, available today. In a direct coupled circuit they also have less drift. Our new transistor voltmeters for AC and DC have lowest ranges of 10 μ V and highest ranges of 1 kV full scale.

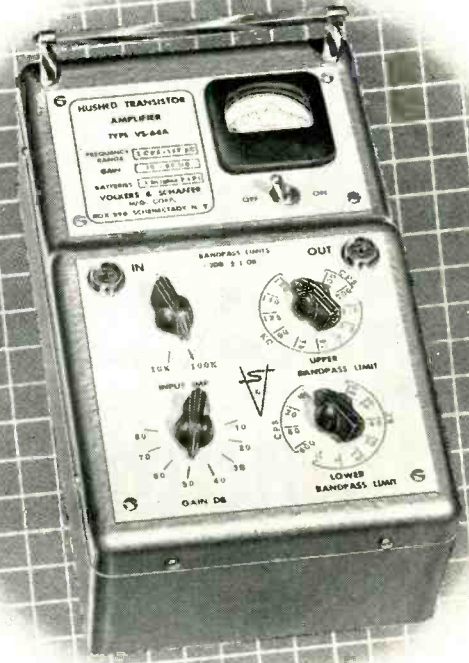

SENSITIVE
AC & DC
AMPLIFIERS
SINGLE &
PUSH - PULL

Type VS - 64A
LOW NOISE
AC-AMPLIFIER
Gain: 80 db
 $E_{Nsh} = 0.45 \mu$ V
(B = 60 kc)
Range: 2 cps-180
kc.

The discovery of the principle of "Hushed Transistor" operation by Dr. W. K. Volkers and Mr. Norman E. Pedersen, which was first disclosed at the National Electronic Conference in Chicago, a year ago, has led to the development of pre-amplifiers for AC and DC which have less than 500 μ V RMS noise voltage, referred to the shorted input terminals. These amplifiers have been in production during the past 12 months and have given an excellent account of themselves.

Visit Booths 3204-3206 IRE Show, N. Y. Coliseum.



MILLIVAC INSTRUMENT CORP.

BOX 997, SCHENECTADY, N. Y.



VOLKERS & SCHAFFER MFG. CORP.

Box 996, Schenectady, N. Y.

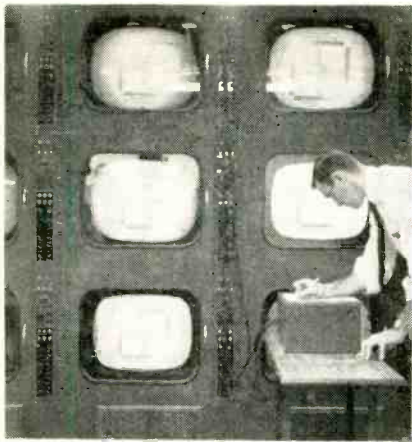

Envelopes undergo life test at Corning Glass

number of tv set makers have the wide angle receivers on the market. The bulbs are 3 inches shorter than 90-degree bulbs and weigh about five pounds less.

Corning Glass has two types of 110-degree 21-inch bulbs. One is ready for production and the other is being sampled to manufacturers. The company uses a process for flame-proofing the bulbs which substantially reduces thermal shock breakage during evacuation and other tube manufacturing operations.

Cathode-ray tubes for radar are also undergoing a change. The tubes are now being made with optical quality faceplates so that glass imperfections cannot hide small blips.

Stand-in For Atlas

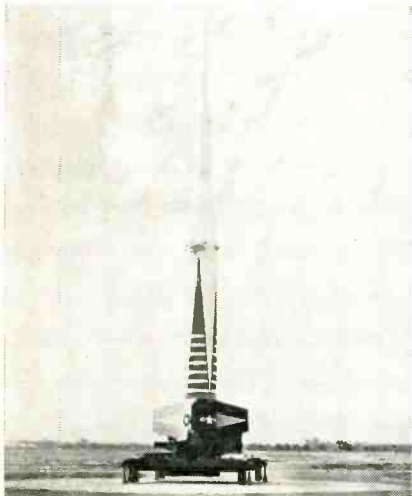

High as a four-story building Lockheed's three-stage X-17 missile helps solve problems that will arise when ICBM's reenter earth's atmosphere

Meetings Ahead

Feb. 27-28: Symposium On Nuclear Radiation Effects On Semi-conductor Devices and Materials, Advisory Group On Electron Tubes, Western Union Auditorium, New York, N. Y.

March 11-15: 1957 Nuclear Congress, EJC, Convention Hall, Phila., Pa.

March 18-21: IRE National Convention, Waldorf-Astoria Hotel, New York Coliseum, New York, N. Y.

March 18-21: Military Automation Show, Cancelled.

Apr. 8-11: British Radio And Electronic Component Show, Grosvenor House and Park Lake House, London, England.

Apr. 9-10: Annual Industrial Electronics Educational Conf., IRE, Armour Research, Ill. Institute of Technology, Chicago, Ill.

Apr. 11-13: Southwest IRE Regional Conference & Electronics Show, Shamrock Hilton Hotel, Houston, Texas.

Apr. 14-16: National Symposium On Telemetering, IRE, Sheraton Hotel, Phila., Pa.

Apr. 23-25: International Symposium On the Role of Solid State Phenomena In Electric Circuits, IRE, Eng. Soc. Bldg., New York, N. Y.

Apr. 24-26: Seventh IRE Region Technical Conference & Trade Show, San Diego, Calif.

Apr. 26-27: Eleventh Annual Spring Technical Conference On TV, IRE, Engineering Society Bldg., Cincinnati, Ohio.

Apr. 29-May 1: Third National Flight Test Instrumentation Symposium, ISA, Statler Hotel, Los Angeles.

May 1-3: 1957 Electronic Components Symposium, Morrison Hotel, Chicago, Ill.

May 9-10: 1957 PGM-TT Meeting, Western Union Auditorium, New York, N. Y.

May 13-15: National Aero & Navigational Electronics Conference, IRE, Dayton, Ohio.

May 14-16: Industrial Nuclear Technology Conference, ARF, Ill. Tech, Nucleonics Magazine, Museum of Science and Industry, Chicago, Ill.

May 20-23: 1957 Electronic Parts Distributors Show, Conrad Hilton Hotel, Chicago, Ill.

May 22-25: URSI Spring Meeting, Hotel Willard, Washington, D. C.

May 27-29: 1957 National Telemetering Conference, AIEE, ISA, IAS, Hotel Cortez, El Paso, Texas.

June 6-7: First National Symposium On Production Techniques, IRE, Willard Hotel, Washington, D. C.

Aug. 20-23: 1957 WESCON, IRE, WCEMA, Cow Palace, San Francisco, Calif.

Industry Shorts

► **Thirty-three** newly developed large-screen projection tv units have been acquired by Upjohn Co., pharmaceutical manufacturers, from GPL.

► **New magnetic alloy**, developed at Bell Labs called Supermendur, has high permeability and lower hysteresis losses at higher flux densities than any material heretofore available, according to Bell.

► **North American Philips Co.** has acquired about 2,000 U.S. patents and 1,200 patent applications for-

merly held by the Hartford National Bank and Trust Co., as trustee. They cover inventions made in the research labs of Philips in Holland and other countries.

► **Output** of electronic equipment in the capital goods field, by British firms in 1956, is expected to be greater than that in the radio and tv side of the industry, according to Britain's Radio Communication and Electronic Engineering Association.

► **Plant** for making electronic modules was opened in Puerto Rico by Modular Systems.

NEW

. . . All Electronic High-Level Broad-Band Sweeping Oscillator with MARKERS WHERE YOU WANT THEM!



KAY *Vari-Sweep* MODEL RADAR

A Vari-Sweep *With Markers* for Rapid, Accurate Alignment of Radar IF's

SWEEP

- High Output—1.0 V rms into 70 Ohms
- Wide Range—10-145 mc, All at Fundamental
- Constant Output—Fast-Acting A.G.C.

MARKERS

- Variable—Birdie Pip Direct Reading Frequency Dial 5-170 mc
- Crystal—11 Precise Markers, Individually Switched—to Customers' Specifications

SPECIFICATIONS

Range: Fundamental frequency—10-145 mc, continuously variable in 6 overlapping bands accurately calibrated on a direct reading dial.

RF Output: 1.0 V rms into 70 ohms. Flat within ± 0.5 db over widest sweep and tuning range.

Sweep Width: Continuously variable to 60% of center frequency below 50 mc, 30 mc sweep width above 50 mc.

Sweep Rate: Variable around 60 cps. Also line lock at 60 cps.

Markers: Variable, Birdie Pip type continuously variable from 5 to 170 mc in 6 overlapping

bands. Calibrated to $\pm 1.0\%$ on separate direct reading dial. 11 individually switched, crystal-controlled, pulse-type marks over the band width, providing separate and simultaneous operation.

Attenuators: Switched 20, 10, and 3db plus continuously variable 6 db.

Marker Amplitude: Continuously variable zero to 10 V positive.

Power Supply: Electronically regulated 105 to 125 V AC. 50-60 cycles.

Price: \$950.00 F.O.B. Plant

SEE US
AT THE IRE SHOW
BOOTHS 2608-09-10

KAY

ELECTRIC COMPANY

Dept. E-3, 14 Maple Avenue, Pine Brook, N. J. • CAldwell 6-4000

Announcing the Raytheon

— a new type of broadband,
high power.....



**QK520
AMPLITRON
TYPICAL OPERATION (PULSED)**

ANODE VOLTAGE	40 kv
ANODE CURRENT	35 amps
PEAK POWER OUTPUT	800 kw
AVERAGE POWER OUTPUT	1200 watts
EFFICIENCY	55%
OPERATING BAND (± 1 db)	1225--1350 Mc
PEAK POWER INPUT	80 kw
PHASE STABILITY WITH ANODE CURRENT	1°/amp

The Amplitron is a new type of tube developed by Raytheon, capable of power amplification at microwave frequencies. Amplification is obtained over a broad range of frequencies with no mechanical or electrical adjustments required. This device is a derivative of the magnetron and retains many of its advantages—such as high operating efficiency, construction simplicity, small size, light weight, low operating voltage. Where efficiency counts in high-power systems, the broadband Amplitron has applications of major significance.

The Amplitron uses crossed electric and magnetic fields, a reentrant beam produced by a magnetron-type cathode, and a non-reentrant broadband circuit matched at either end to external circuits.

AMPLITRON*

cross-field microwave amplifier

.....high efficiency

This amplifier has bandwidths of 10% with efficiencies of 50-70% over the entire band. Variations in anode current or voltage have little effect upon the total phase shift. This results in very low phase pushing and excellent reproduction of the input spectrum despite slow pulse rise time and ripple. Because the device has low insertion loss, duplexing may be accomplished at the input rather than the output of the final rf amplifier.

The Amplitron is another example of Raytheon's unequalled leadership in microwave tubes. A limited quantity of preliminary literature will be available shortly; to be sure of a copy, write now.

See it at the I.R.E.—Raytheon Booths 2611-14



Excellence in Electronics

RAYTHEON MANUFACTURING COMPANY

Microwave and Power Tube Operations, Section PT-02

Waltham 54, Massachusetts

*Raytheon Trademark

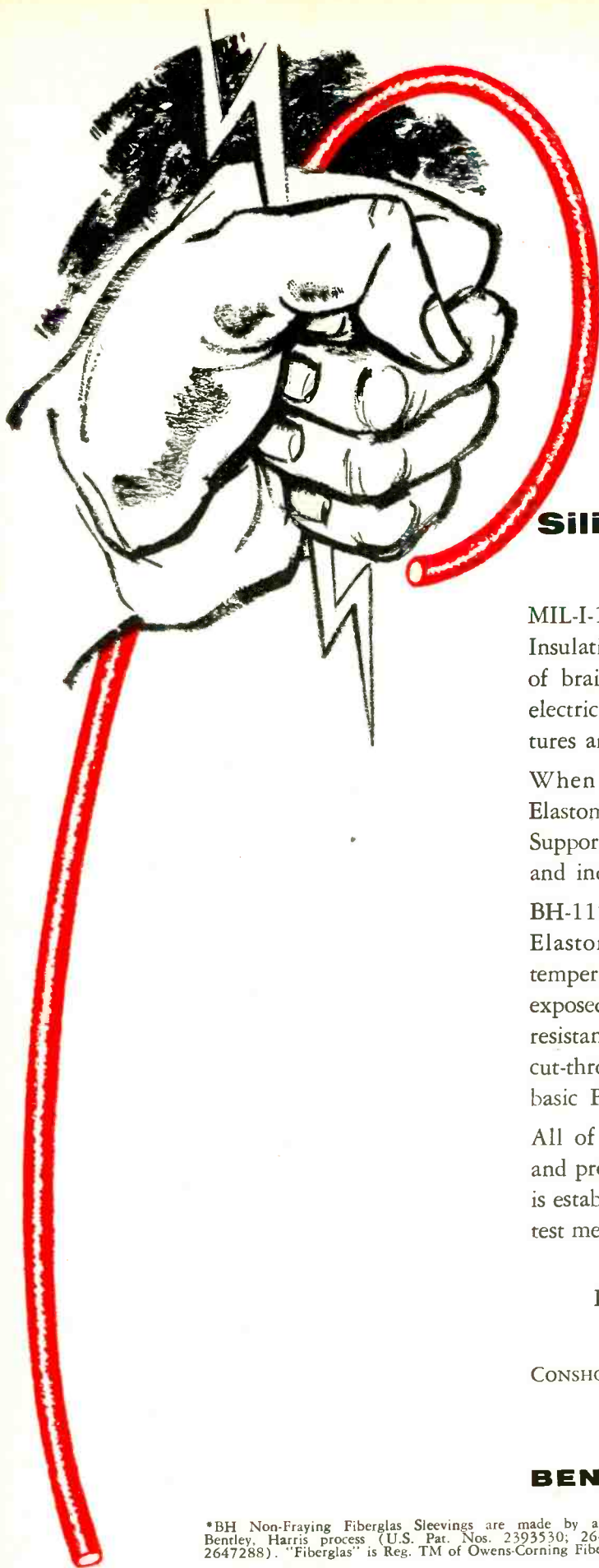

**For all the stringent
requirements of
MIL-I-18057**

BH "1151"

Silicone Rubber Sleeving

MIL-I-18057 is a functional type test — for Class H Insulating Sleeving. It sets the standard for performance of braided Fiberglas Silicone Elastomeric sleeving in electrical insulating systems subjected to high temperatures and mechanical stress.

When you specify BH-1151 Fiberglas Silicone Elastomeric Sleeving, it meets these high standards. Supported by long record of service in both military and industrial applications.

BH-1151 combines the superior qualities of Silicone Elastomer — extreme low temperature and high temperature flexibility, resistance to degradation when exposed to high temperature, chemical inertness, and resistance to crazing — with the support, resistance to cut-through and dimensional stability offered by the basic Fiberglas braid.

All of these properties are required by MIL-I-18057 and proof of BH-1151's ability to meet these standards is established by data obtained in each of the prescribed test methods. These data sheets are available on request.

BENTLEY, HARRIS MANUFACTURING CO.

303 Barclay Street

CONSHOHOCKEN, PA.

TELEPHONE: TAYLOR 8-0634

BENTLEY, HARRIS

*Fiberglas**
SLEEVINGS

*BH Non-Fraying Fiberglas Sleeveings are made by an exclusive Bentley, Harris process (U.S. Pat. Nos. 2393530; 2647296 and 2647288). "Fiberglas" is Reg. TM of Owens-Corning Fiberglas Corp.

For the most dependable printed circuits, you need the high bond strength, workability, heat-resistance of **C-D-F DILECTO[®] METAL-CLAD LAMINATES**

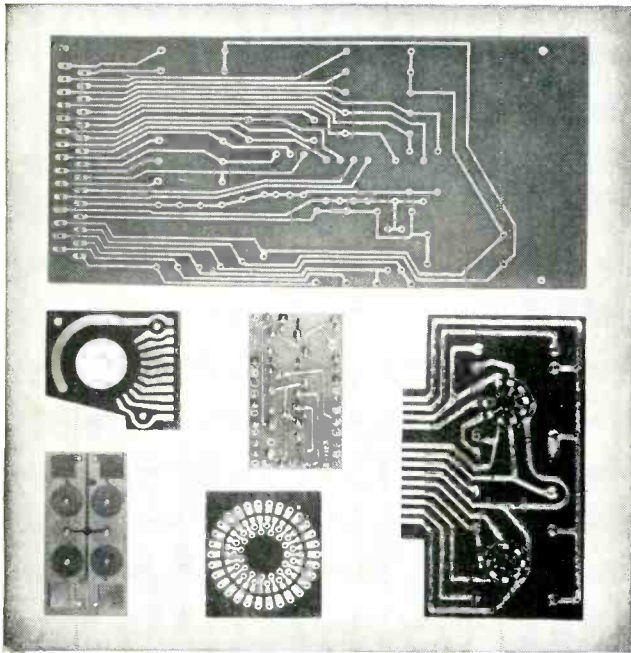

Printed circuits based on C-D-F materials are being used with great success in military electronic equipment, commercial television and radio sets, telephone switchboards—even sub-miniature radio-sonde equipment and hearing aids.

Photos courtesy of Photocircuits, Inc., Glen Cove, N. Y.

HIGH BOND STRENGTH—C-D-F's special adhesive for metal-clad Dilecto bonds the copper foil to the plastic without affecting the laminate's superior electrical properties. Heat-resistance, dissipation factor, dielectric constant, dielectric strength, and insulation resistance of the Dilecto base remain unaffected. The closely-bonded foil can be etched cleanly and dipped in hot solder to 450°F. for ten seconds with a guarantee of no blistering or separating. Metal-Clad Dilecto can be punched or machined either before or after etching.

EXCELLENT WORKABILITY—On all four Dilecto metal-clad grades, you can solder, punch, saw, and assemble components either by hand or automatically. Thanks to the inherently superior workability of the plastics laminate over that of ceramic-type materials, Dilecto can be dropped, jammed into tight chassis, and otherwise treated roughly on the assembly line and in service.

HIGH HEAT-RESISTANCE—Metal-Clad Dilecto Laminates are made of phenolic, epoxy, or Teflon* resin for various conditions of service and assembly, and have either cellulosic paper or woven glass-fabric base. All are ideally suited to printed-circuit applications in which heat-dissipation is a major problem. Continuous exposure to high ambient operating temperatures in enclosed electronic equipment has no significant effects on Dilecto's electrical and physical properties.

UNLOAD YOUR HEADACHE HERE! C-D-F, a big, reliable source of supply, can help you get the most for your printed-circuit money by reducing rejects, lowering fabrication costs, assuring dependable quality every time. Send us your print or problem, and we'll gladly supply appropriate test samples free. See our catalog in the Product Design File (Sweet's) or send for the new 20-page Dilecto catalog. Let your nearby C-D-F sales engineer (listed in Sweet's) help you right from the design stage!

TYPICAL PROPERTY VALUES

	Copper-Clad PHENOLIC (Grade XXXP-26)	Copper-Clad PHENOLIC (Grade XXXP-28)	Copper-Clad EPOXY (Grade GB-181E)	Copper-Clad TEFLON* (Grade GB-112T)
BOND STRENGTH—0.0014" foil (Lbs. reqd. to separate 1" width of foil from laminate)	7 to 11	5 to 9	8 to 12	4 to 8
MAXIMUM CONTINUOUS OPERATING TEMP. (Deg. C.)	120	120	150	200
DIELECTRIC STRENGTH (Maximum voltage per mil.)	800	800	650	700
INSULATION RESISTANCE (Megohms) 96 hrs. at 35° C. & 90% RH	50,000	25,000	20,000	Over 10 ⁶ megohms
DIELECTRIC CONSTANT 10 ⁶ Cycles	4.20	4.20	4.54	2.85
DISSIPATION FACTOR 10 ⁶ Cycles	0.026	0.052	0.018	0.0006
ARC-RESISTANCE (Seconds)	10	5	120	180
TENSILE STRENGTH (psi.)	16,000 x 13,000	12,000 x 10,000	48,000 x 44,000	23,000 x 21,000
FLEXURAL STRENGTH (psi.)	21,000 x 18,000	18,000 x 16,000	65,000 x 55,000	13,000 x 11,000
IZOD IMPACT STRENGTH edgewise (ft. lbs. per inch of notch)	0.40 x 0.35	0.40 x 0.35	13.5 x 11.5	6.0 x 5.0
COMPRESSIVE STRENGTH flatwise (psi.)	28,000	22,000	62,000	20,000
BASE MATERIAL OF LAMINATE	Cotton rag paper	Cotton rag paper	Medium-weave, medium-weight glass cloth	Fine-weave, medium-weight glass cloth
COLOR OF UNCLAD LAMINATE	Natural greenish	Natural Brown	Natural	Natural

All these standard grades are available with 0.0014", 0.0028", 0.0042", or thicker electrolytic or rolled copper foil on one or both surfaces. Other metal foils and other resin-and-base combinations can be supplied on special order.

*duPont Trademark



CONTINENTAL DIAMOND FIBRE

CONTINENTAL-DIAMOND FIBRE DIVISION OF THE BUDD COMPANY, INC.

NEWARK 16, DELAWARE

Direct Reading Spectrum Analyzer

- for
- Visual frequency calibration — high resolution
 - Leakage and interference measurements
 - Standing wave measurements
 - Pulse modulation analysis
 - Sensitive receiver

The **BASIC SCOPE** for **VISUAL** **MICROWAVE**

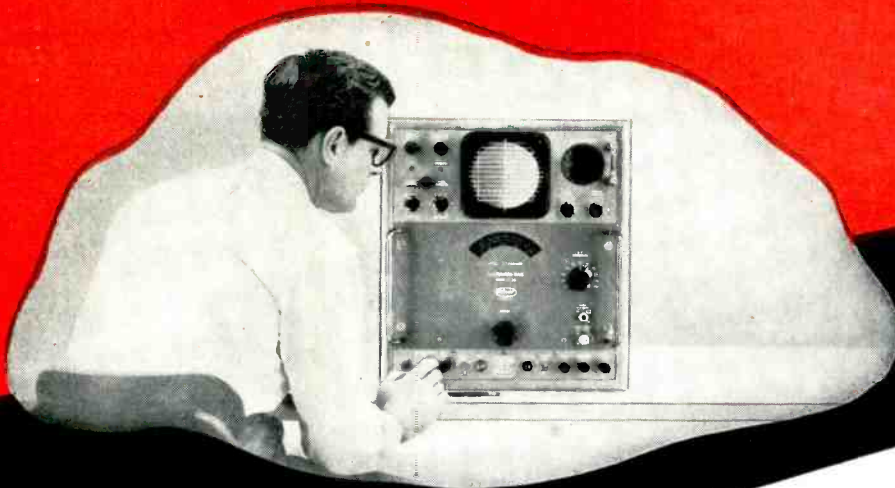

SPECIFICATIONS

Model No.	Equipment
Model Du.....	Spectrum Display and Power Unit
Model STU-1...	RF Tuning Unit 10-1,000 mc.
Model STU-2A.	RF Tuning Unit 910-4, 560 mc.
Model STU-3A.	RF Tuning Unit 4,370-22,000 mc.
Model STU-4...	RF Tuning Unit 21,000-33,000 mc.
Model STU-5...	RF Tuning Unit 33,000-44,000 mc.
	Frequency Range: 10 mc to 44,000 mc.
	Frequency Accuracy: $\pm 1\%$
	Resolution: 25 kc.
	Frequency Dispersion: Electronically controlled, continually adjustable from 400 kc to 25 mc per one screen diameter (horizontal expansion to 20 kc per inch)

Frequency differences as small as 40 kc measurable by means of variable frequency marker with adjustable amplitude. Portable and completely self-contained.

Input Impedance: 50 ohms—nominal
Overall Gain: 120 db
Input Power: 400 Watts
Sensitivity: (minimum discernible signal)
STU-1: 10-400 mcs—89 dbm
400-1,000 mcs—84 dbm
STU-2A: 910-2,200 mcs—87 dbm
1,980-4,560 mcs—77 dbm
STU-3A: 4,370-10,920 mcs—75 dbm
8,900-22,000 mcs—60 dbm
STU-4: 21,000-33,000 mcs—55 dbm
STU-5: 33,000-44,000 mcs—45 dbm
Attenuation:
RF internal 100 db continuously variable (STU-1, STU-2A, STU-3A)
IF 60 db continuously variable

Broadband 10-44,000 mc

Now, the Polarad Model TSA Spectrum Analyzer provides the same visual advantages for microwave testing as the standard oscilloscope accomplishes for low frequency signals. This is a "must" instrument for microwave work! It displays with high sensitivity on a bright easily defined CRT, pulse modulation components, frequency differences, attenuation and band width characteristics, leakage detection, radiation and interference signals, and VSWR information.

This is visual instrumentation—it provides immediate and complete information because of the high resolution obtainable.

Frequencies are read directly on the linear dial with 1% accuracy as the set is tuned. Maximum reliability and long life are assured through use of non-contacting oscillator plungers. A variable frequency marker with both frequency and amplitude adjustable is provided.

ANALYSIS

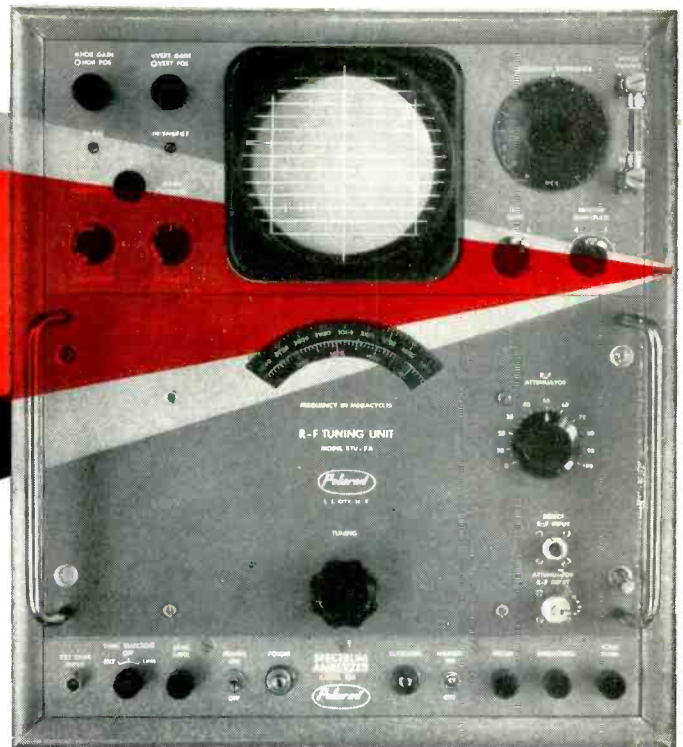

Write today—directly to Polarad, or your nearest Polarad representative—to find out how the Model TSA Spectrum Analyzer can speed your research and solve your microwave measurement and testing problems.

Write for your copy of the Polarad "Handbook of Spectrum Analyzer Techniques". 50c per copy. Includes discussion of Spectrum Analyzer operation, applications and formulae for analysis techniques.

AVAILABLE ON EQUIPMENT LEASE PLAN

FIELD MAINTENANCE SERVICE AVAILABLE THROUGHOUT THE COUNTRY

For private demonstration
without obligation
ask for the



to stop
at your plant



ELECTRONICS CORPORATION
43-20 34th Street, Long Island City 1, N. Y.

REPRESENTATIVES: Albany, Albuquerque, Atlanta, Baltimore, Boston, Chicago, Cleveland, Dayton, Denver, Englewood, Fort Worth, Kansas City, Los Angeles, New York, Philadelphia, Portland, Rochester, St. Louis, San Francisco, Schenectady, Stamford, Syracuse, Washington, D. C., Winston-Salem, Canada: Arnprior, Ontario.
Resident Representatives in Principal Foreign Cities

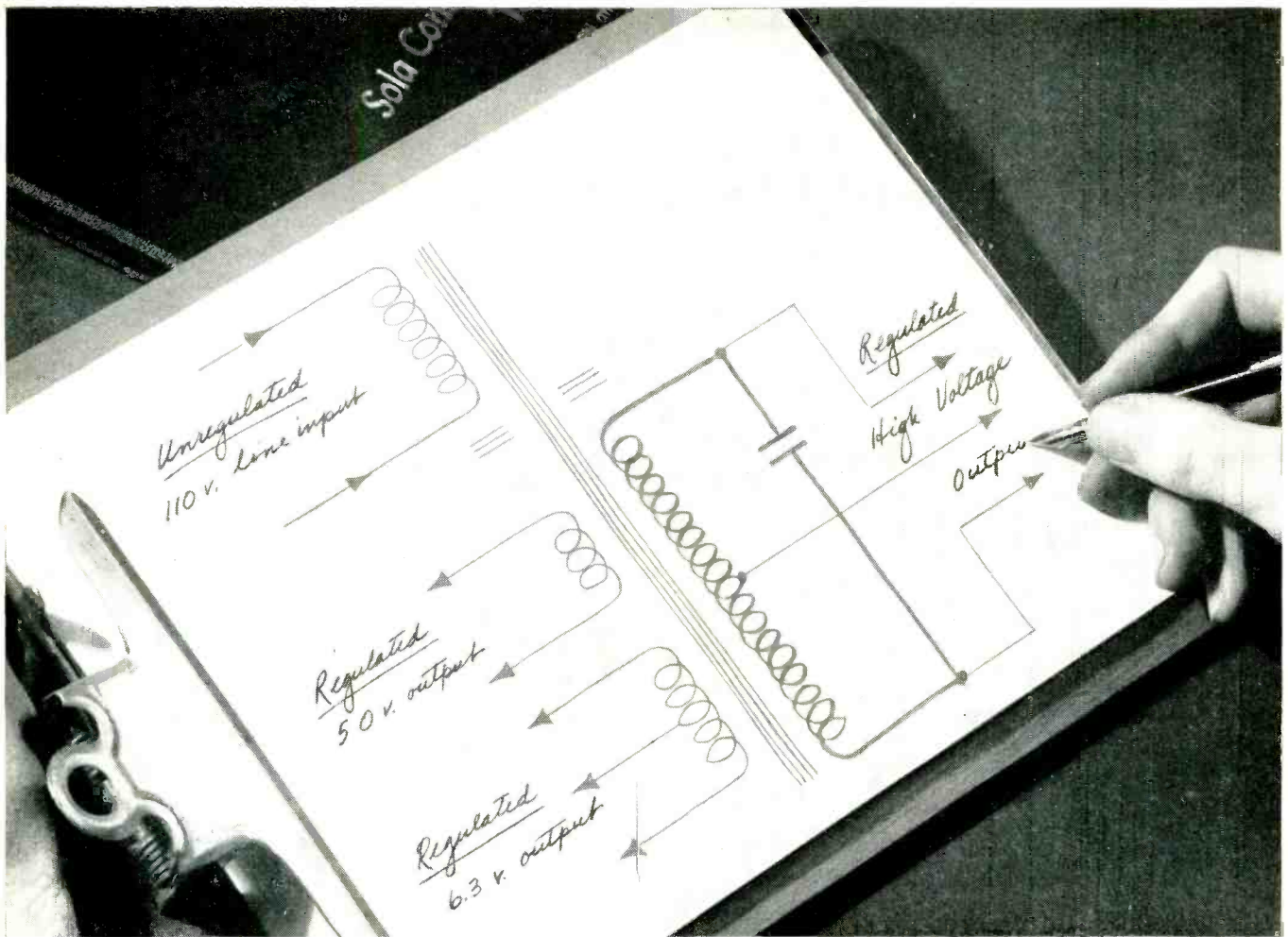

SCHEMATIC DIAGRAM OF SOLA CIRCUIT modified to supply regulated plate and filament voltages. Regulation on one stepped-up output and two

stepped-down outputs is within $\pm 3\%$ for input variations of $\pm 13\%$. Other units available regulate as close as $\pm 1\%$ for input variations of $\pm 15\%$.

YOU GET VOLTAGE REGULATION AND MORE FROM A SOLA:

Closely Regulated Voltage Plus Transformer Step-Up or Step-Down with Sola Constant Voltage Transformers

Today's complex electrical and electronic equipment, with its narrow limits for adequate performance, makes a fixed level of input voltage virtually essential. There are many fine voltage regulators available for this duty alone. However, the Sola Constant Voltage Transformer delivers one-to-one, stepped-up, or stepped-down voltages closely regulated. One Sola unit may replace both voltage-regulating circuit or component, and conventional power transformer.

The Sola Constant Voltage Transformer is a static-

magnetic voltage regulator. It offers many important advantages over other stabilizers which depend solely upon saturation of core materials for their regulating action; or electronic types employing tubes.

To meet the exact requirements of many load devices or service conditions, Sola voltage regulators are available in stock models, or custom designs in production quantities. Your Sola representative will be happy to provide you with information on their feasibility for your particular application.

SOLA

Constant Voltage
TRANSFORMERS



Write for Bulletin 7C-CV-170
SOLA ELECTRIC CO.
4633 W. 16th Street
Chicago 50, Illinois

CONSTANT VOLTAGE TRANSFORMERS • FLUORESCENT LIGHTING BALLASTS • MERCURY VAPOR LIGHTING TRANSFORMERS
SOLA ELECTRIC CO., 4633 West 16th Street, Chicago 50, Illinois, Bishop 2-1414 • NEW YORK 35: 103 E. 125th St., Trafalgar 6-6464
PHILADELPHIA: Commercial Trust Bldg., Rittenhouse 6-4988 • BOSTON: 272 Centre Street, Newton 58, Mass., Bigelow 4-3354 • CLEVELAND 15:
1836 Euclid Ave., Prospect 1-6400 • KANSAS CITY 2, MO.: 406 W. 34th St., Jefferson 4382 • LOS ANGELES 23: 3138 E. Olympic Blvd., Angelus
9-9431 • SOLA ELECTRIC (CANADA) LTD., TORONTO 17, ONTARIO: 102 Laird Drive, Mayfair 4554 • Representatives in Other Principal Cities

Waldes Truarc Retaining Rings Eliminate Machining and Parts—Cut Assembly Time on Drill and Tapper

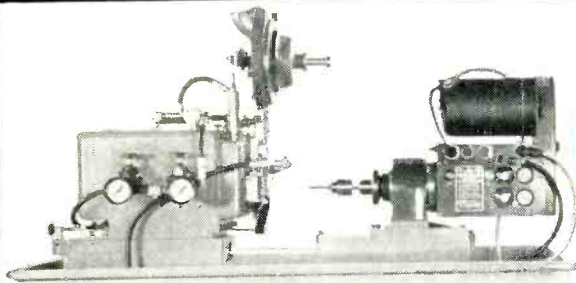

Beco Model 410 Drill and Tapper

The Batchelder Engineering Co., Inc., Springfield, Vermont uses 4 different sizes of 2 different type Waldes Truarc rings in their new BECO Model 410 Automatic Drill and Tapper. Truarc rings speed assembly, reduce machining, improve design.

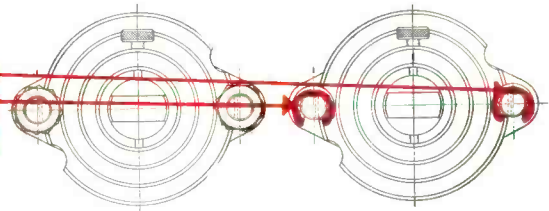

ALTERNATE DESIGN

TRUARC DESIGN

Clamp Cylinder Rod Stop Assembly

Truarc "E" Rings (Series 5133) replace stop nuts in the Clamp Cylinder assembly. They eliminate need for threading 2 rods... the danger of cross-threading nuts... and costly rejects. Truarc Rings cut assembly time and cost.

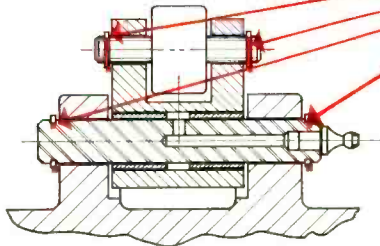

Bell Crank Pivot Assembly

Truarc Rings (Series 5100) in Bell Crank Pivot assembly permit grease hole not possible with cotter pin fastener. Use of nuts would have increased machining and assembly costs considerably.

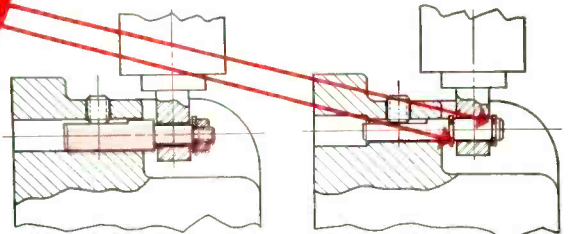

ALTERNATE DESIGN

TRUARC DESIGN

Hopper Cylinder Anchor Pin Assembly

2 Truarc Rings (Series 5100) secure and position end of vertical air cylinder. Rings eliminate extra cost of machining 3-diameter pin, threading and undercutting... plus nut and washer. Assembly is quick and sure.

Whatever you make, there's a Waldes Truarc Retaining Ring designed to improve your product... to save you material, machining and labor costs. They're quick and easy to assemble and disassemble, and they do a better job of holding parts together. Truarc rings are precision engineered and precision made, quality controlled from raw material to finished ring.

36 functionally different types... as many as 97

different sizes within a type... 5 metal specifications and 14 different finishes. Truarc rings are available from 90 stocking points throughout the U. S. A. and Canada.

More than 30 engineering-minded factory representatives and 700 field men are available to you on call. Send us your blueprints today... let our Truarc engineers help you solve design, assembly and production problems... without obligation.

For precision internal grooving and undercutting... Waldes Truarc Grooving Tool!

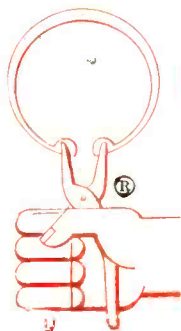

WALDES
TRUARC[®]
RETAINING RINGS

WALDES KOHINOOR, INC.
47-16 AUSTEL PLACE, L. I. C. 1, N. Y.

Waldes Kohinoor, Inc., 47-16 Austel Place, L. I. C. 1, N.Y.
Please send the new supplement No. 1 which brings Truarc Catalog RR 9-52 up to date.
(Please print)

Name _____
Title _____
Company _____
Business Address _____
City _____ Zone _____ State _____

EO39

WALDES TRUARC Retaining Rings, Grooving Tools, Pliers, Applicators and Dispensers are protected by one or more of the following U. S. Patents: 2,382,948; 2,411,426; 2,411,761; 2,416,852; 2,420,921; 2,428,341; 2,439,785; 2,441,846; 2,455,165; 2,483,379; 2,483,380; 2,483,383; 2,487,802; 2,487,803; 2,491,306; 2,491,310; 2,509,081; 2,544,631; 2,546,616; 2,547,263; 2,558,704; 2,574,034; 2,577,319; 2,595,787, and other U. S. Patents pending. Equal patent protection established in foreign countries.



ELECTRONIC SLIDE RULE ILLUSTRATES SUPERIORITY OF BORG MICROPOTS

LOADING ERROR SOLVED BY BORG

Loading error, an important consideration in many potentiometer applications, has been solved by Borg.

LOADING ERROR DEFINED

Loading error is caused by current flow through the contact arm to a finite value of resistance (RL) connected to the output terminals of the pot. Ratio of total resistance of the pot to the load resistance determines the linearity error caused by the load. (Fig. 2).

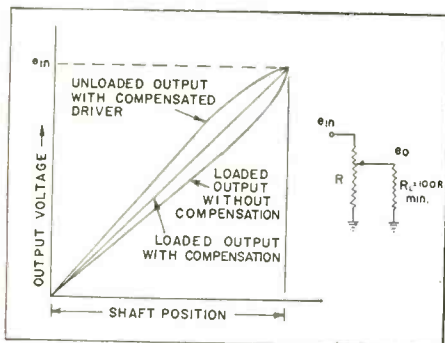

Fig. 2—Series resistance adjustment to minimize loading error.

PARTIAL REMEDIES

Fig. 2 shows a restriction of the usable portion of the pot to the relatively flat portion of the curve. This requires trim-

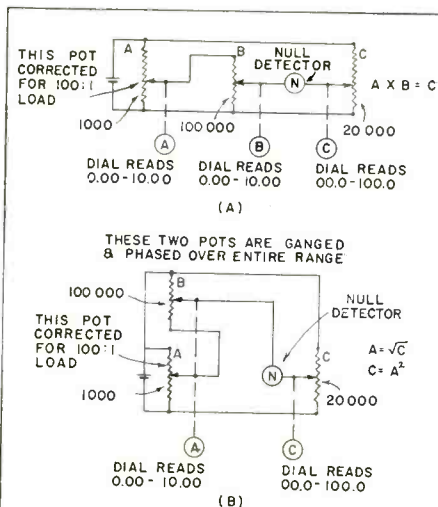

Fig. 1—Electronic slide rule for multiplication (A) and for squares and square roots (B).

THE ELECTRONIC SLIDE RULE

Electronic slide rule. (Fig. 1) was designed to illustrate this correction method in an actual application. It is not possible without two features found only in Borg's 900 Series, accurate load correction over the entire range of 0 to 100%, in pot A, and absolute linearity on all pots. The ganged assembly of pots A and B shown in (B) phased over entire range, illustrates another valuable feature of the Borg 900 Series Micropot Potentiometer.

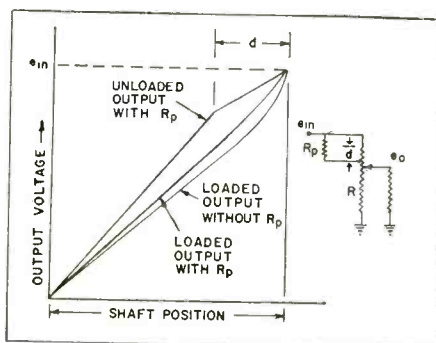

Fig. 3—Preloading to minimize loading error.

ming resistors and at best makes use of less than $\frac{2}{3}$ of the total rotation.

Another method is to tap the resistance

wire at the point of maximum load error and make straight line approximations by use of a padding resistor (RP), Fig. 3. Load error is not entirely eliminated and the cost of the tap, selection and installation of the trimmer, is substantial.

THE BORG METHOD

The Borg method of eliminating load error is made possible by the design of the Borg 900 Series Micropot. Loading error correction is built into the potentiometer by means of an integral nonlinear actuator contact drive. It is computed to introduce motion equal in magnitude and opposite in sign to the error of a given load ratio. (Fig. 4).

This method provides accurate load correction over the entire range of 0 to 100% without trimming or tapping. Dual correction can be made when the application requires positive and negative values from a center tap.

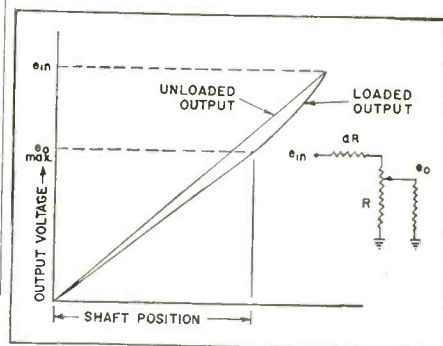

Fig. 4—Compensated drive to offset loading error, 100:1 ratio.

BORG 900 SERIES MICROPOTS ACHIEVE OPTIMUM PERFORMANCE

Borg has designed the 900 Series to achieve optimum electrical and mechanical performance and to meet the most severe environmental conditions while presenting to the equipment designer a highly flexible unit to fill a vast range of applications.

Write for complete engineering data
Catalog BED-A56

BORG EQUIPMENT DIVISION
THE GEORGE W. BORG CORPORATION
JANESVILLE, WISCONSIN



Built by Borg

Square RE-USABLE Metal Pad-Kaging Containers

ELIMINATE majority of handling and storage problems
REDUCE shipping weights and cubic footage



These RE-USABLE Metal Pad-Kaging Containers were developed by PETERS-DALTON for the U. S. Armed Forces. They have been approved and are in use for shipping and storing innumerable items.

P-D Containers eliminate the storing of many cumbersome and highly inflammable materials—they also eliminate the excess labor usually required in packaging such items as delicate radar instruments. Older methods caused finished packages to be heavy and bulky. They were susceptible to breakage and penetration to moisture and fungus. They were wasteful because of their excessive use of man-hours and materials, culminated by the eventual scrapping of the expensive packaging. Also, when reshipping was required, old fashioned containers after having once been opened, were seldom satisfactory for adequate repackaging of the materials — endangering them to damage while in transit. These inadequacies and limitations have been virtually eliminated through P-D RE-USABLE Metal Shipping Containers.



Materials formerly used in packaging one light military electronic item.

Features include: Lightness: Completed packs weigh far less than older style types. Compactness: The P-D RE-USABLE Metal Containers frequently save more than 50% of cubic footage. Economy: Material and man-hour outlays for packaging are reduced 25%.

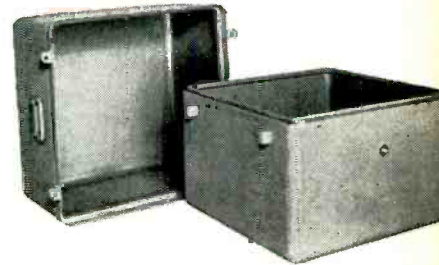

Special Features: Containers are equipped with air fill valves to eliminate dangers of fungus or moisture and dial type humidity indicators. Drop handles furnished for containers weighing less than 200 lbs.—heavier containers have been designed for fork truck lifting. Extremely simple to close, only ordinary bolts (4 on the smallest container to 14 on the largest) are required; the simplest of hand tools perform the closing or opening operations. Optional: Pressure relief valves to equalize inside to outside pressures.

Only two parts to handle.

These RE-USABLE Metal Containers were manufactured by PETERS-DALTON for items ranging from aircraft engines, electronic parts, to large A-N containers in all types and sizes for shipping purposes. Complete engineering and manufacturing facilities are at your disposal for design, testing and fabricating. We'll be glad to tell you more—just write, wire or phone.



P-D Re-Usable Container ready to be closed and sealed. Note the simplicity of design.

STEEL SHIPPING CONTAINER DIVISION



Peters-Dalton INC.

A SUBSIDIARY OF DETROIT HARVESTER CO.

17872 Ryan Road • Detroit 12, Michigan

- Hydro-Whirl Paint Spray Booths
- Industrial Washing Equipment
- Drying and Baking Ovens
- Hydro-Whirl Dust Collecting Systems

Splitting

FOR ACCURATE MEASUREMENT OF

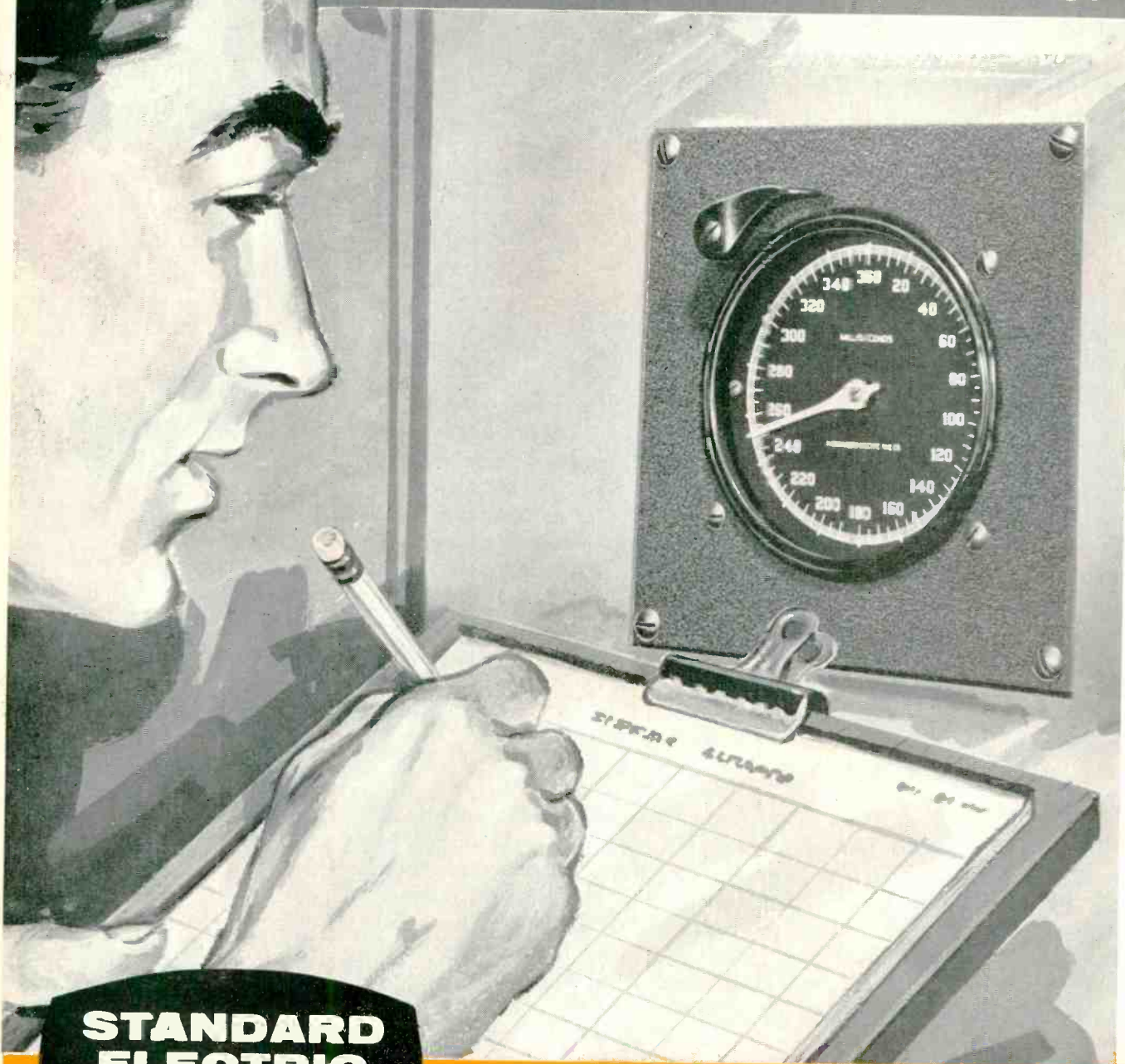

**STANDARD
ELECTRIC**
TIME COMPANY
Springfield 2,
Massachusetts

SINCE 1884







THE STANDARD PRECISION TIMER

is the indispensable STOP Watch in laboratory and test cell, on experimental nuclear projects, precision production, check and final inspection. Many important applications in almost every industrial plant and research laboratory.

Split Seconds

ELAPSED TIME... AS CLOSE AS 0.001 OF A SECOND

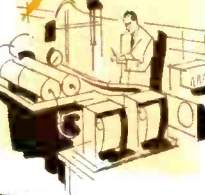
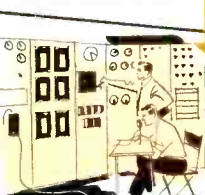
PRACTICALLY ALL Representative Manufacturing, Processing and Research Plants
USE STANDARD PRECISION TIMERS

	<p>At one of the world's largest automotive manufacturers — timing test action in automatic transmission research.</p>		<p>It is our frank belief that literally hundreds of concerns have not yet scratched the surface of usefulness to which Standard Precision Timers can be put to work in their plants.</p>	
<p>For Glenn L. Martin Co.'s Gunnery Trainer — in 12-channel Playback System designed by Cook Research Laboratories.</p>		<p>At Eastman Kodak Co. — timing photo cell controlled exposures in automatic photo printing machine.</p> <p>At Yucca Pass, Nevada Proving Grounds — helping maintain split-second control of atomic bomb tests.</p>		<p>At General Electric Co. — Trumbull Division — measuring operating time of circuit breakers.</p> <p>In Bell Telephone offices throughout the U. S. — timing elements required to complete telephone connections.</p>
	<p>At Bendix — Westinghouse Research Dept. laboratories — measuring brake application and release time to 1/100th of a second.</p>		<p>At American Brass Co. — indicating metalurgical analysis in Direct Reading Spectroscope developed by Baird Associates.</p>	

World's most accurate and rugged time measuring instrument. Built in many different and advanced designs to meet practically every need of precision time measurement. Requires minimum maintenance.

Synchronous motor drive. Electric clutch controlled by manual switch, automatic switch or output of electronic tubes. Manual or electric zero reset.

Model	Scale Divisions	Totalizes	Accuracy
S-100	1/5 sec.	6000 sec.	±.1 sec.
S-60	1/5 sec.	60 min.	±.1 sec.
SM-60	1/100 min.	60 min.	±.002 min.
S-10	1/10 sec.	1000 sec.	±.02 sec.
S-6	1/1000 min.	10 min.	±.0002 min.
S-1	1/100 sec.	60 sec.	±.01 sec.
MST	1/1000 sec.	.360 sec.	±.001 sec.
MST-500	1/1000 sec.	30 sec.	±.002 sec.

SEND TODAY for Bulletin #198 describing entire line with partial list of thousands of customers, and summary of some of the most frequent (and some of the most unusual) ways they use STANDARD ELECTRIC TIMERS.

The STANDARD ELECTRIC TIME Co.
97 Logan St., Springfield 2, Mass.

Please send Bulletin 198 describing your line of instruments for measuring elapsed time as close as 0.001 seconds.

Name.....Title.....

Firm.....

Address.....

We suggest you check your requirements for Standard Timers and other products today. Your order or inquiry will receive prompt attention.



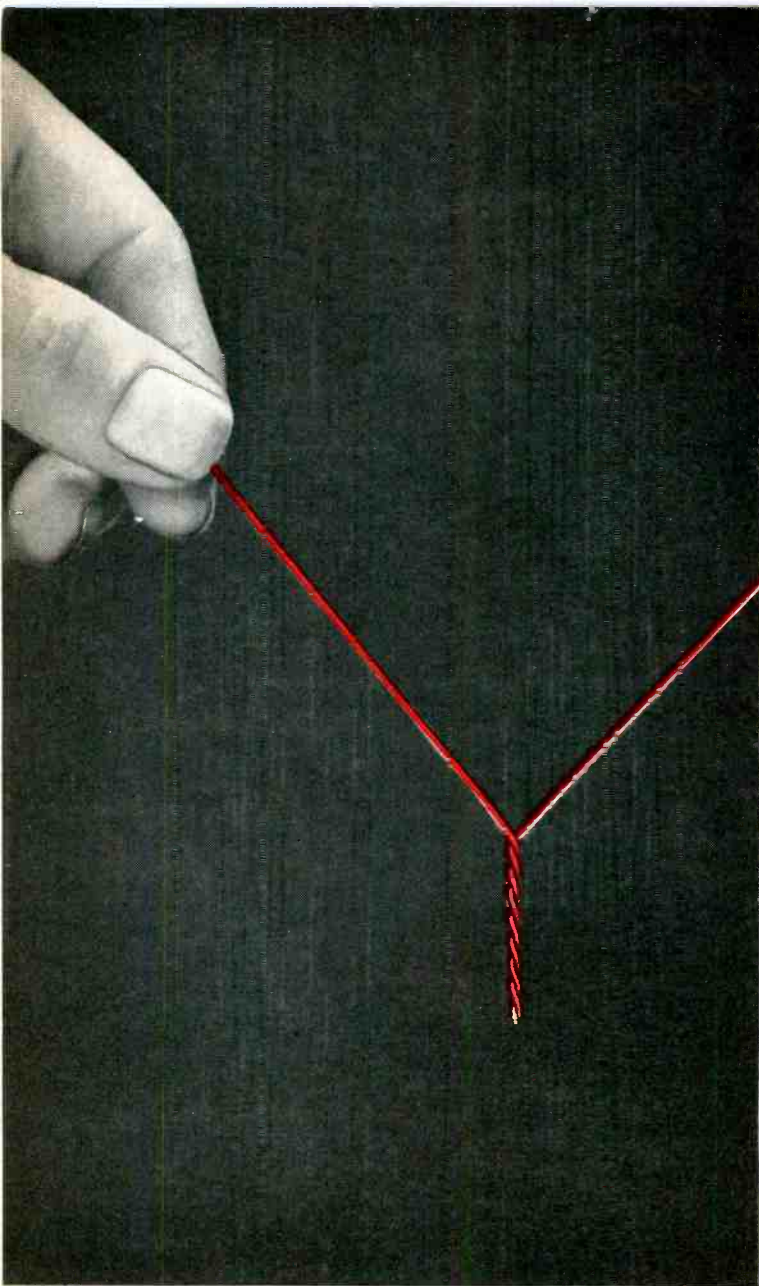

TWIST WIRES . . .

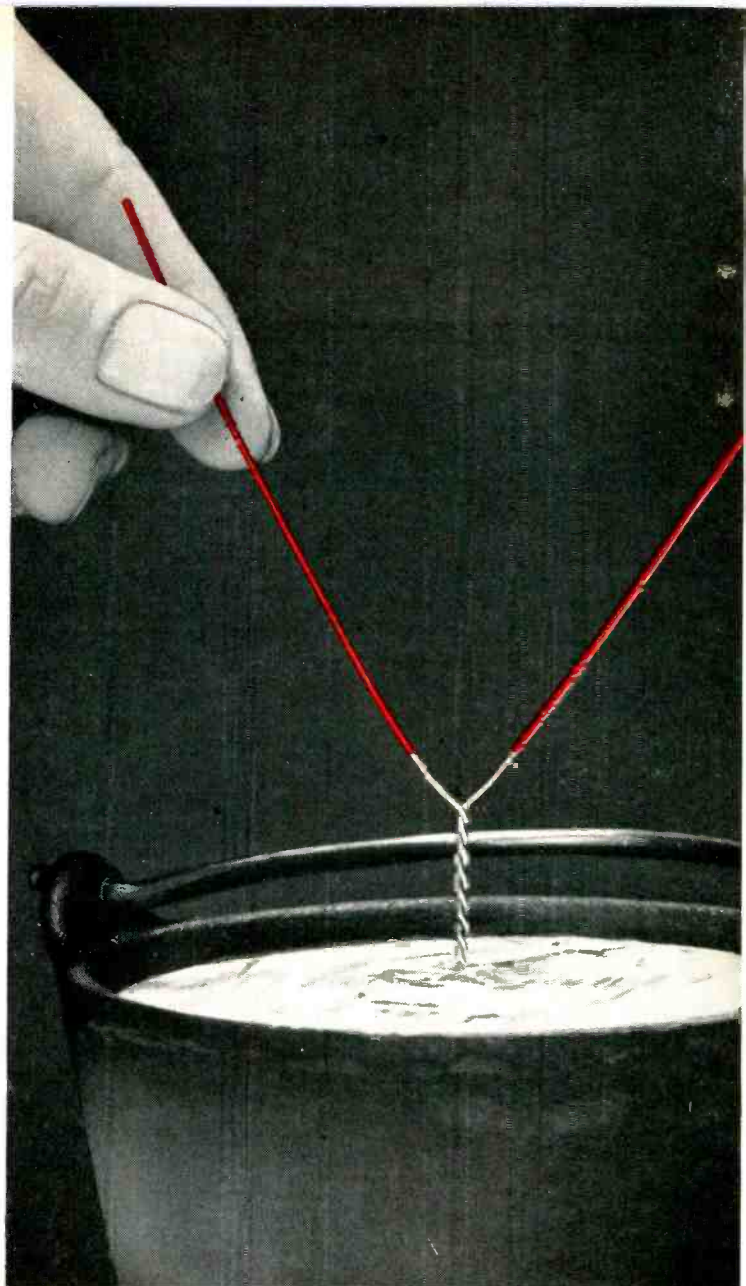

DIP IN SOLDER . . .

Anaconda announces **Analac** an improved

New Analac* film-insulated, solderable magnet wire can be used similarly to Formvar or Plain Enamel—except that it is solderable without stripping!

Soldering by dipping, iron or gun produces a perfect joint—in just one second in finer sizes—without prior removal of the insulation. Analac reduces labor, saves time and money wherever many soldered connections are made, or where small diameter wire makes other means of insulation removal hazardous to the insulation or wire.

Not only this, Analac has the excellent abrasion resistance and other good mechanical properties of the enamel wire you're now using. It handles readily, per-

forms well in high-speed winding.

Analac is colored a bright red with stable dye used many years for identical applications—making it highly visible even in finest sizes. This helps operators feel more secure, results in higher quality work. Distinctive color simplifies its identification, too, from nonsolderable wires.

Analac is available in an exceptionally large range of sizes. The Man from Anaconda will be glad to give you more information and help with a production run in your plant. See "Anaconda" in your phone book—in most principal cities—or write: Anaconda Wire & Cable Company, Magnet Wire Headquarters, Muskegon, Michigan.

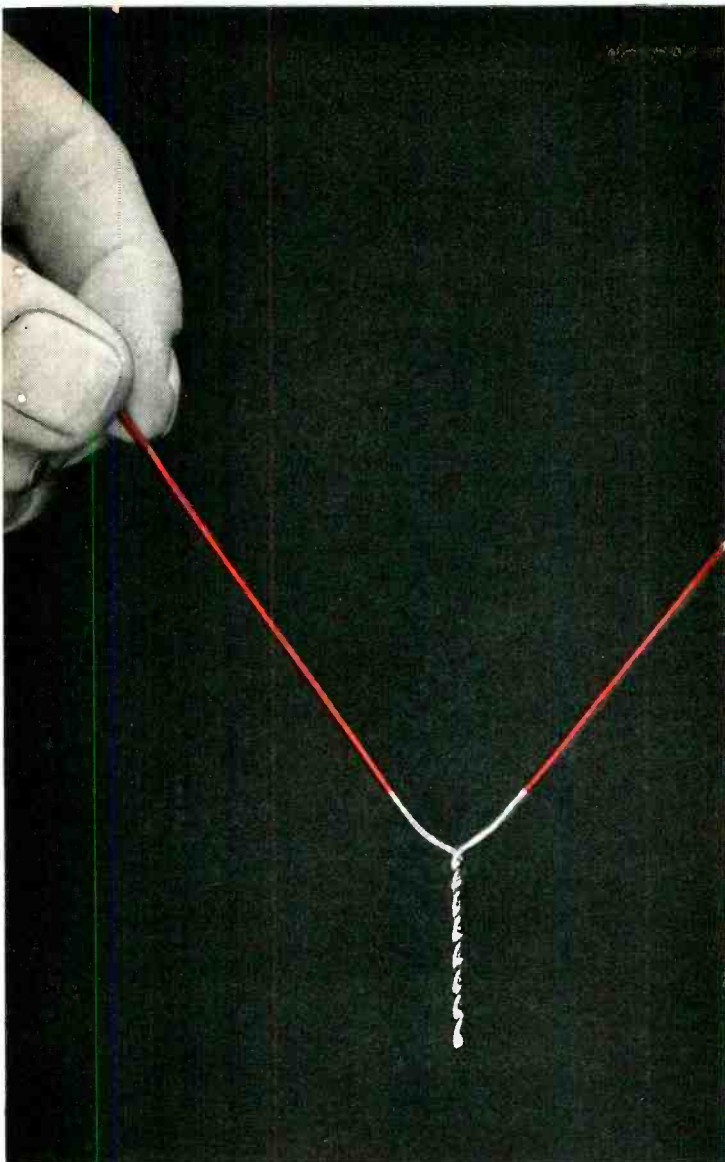

JOINT IS COMPLETED WITHOUT STRIPPING WIRE with Analac wire dipped in a 50-50 tin-lead solder at 360°C (680°F). The insulation is removed at the temperature of molten solder.

solderable magnet wire

See the Man from
ANACONDA[®]
 for ready-to-solder
Analac
 magnet wire

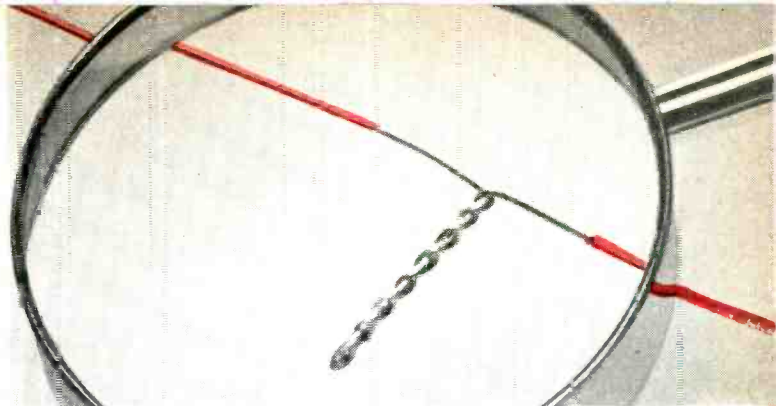

1. STRONG JOINTS—as strong as the same joints made in bare copper wire—are produced. Here in laboratory test, joint holds under high stress.

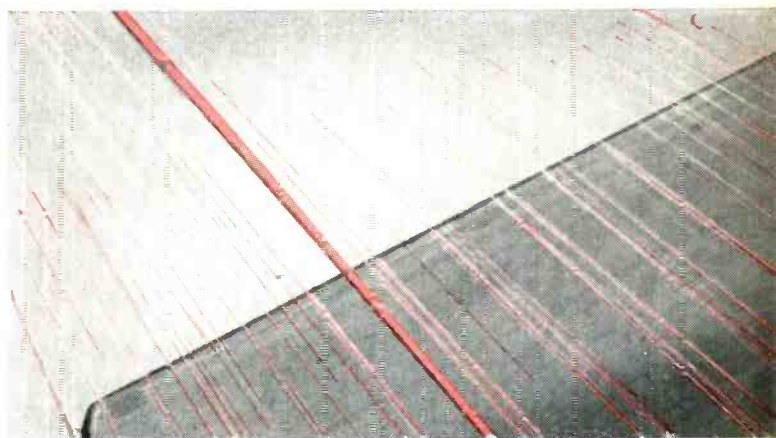

2. EXCELLENT ABRASION RESISTANCE of Analac is shown in this test. It has the same high windability normally associated with Formvar, Plum Enamel.



3. MOLDED-PLASTIC CASES — designed and developed by Anaconda—protect spools of Analac from damage during shipping. Result: no breaks due to bent spools.



NEW CATALOG ON ANALAC
 Yours for the asking.
 Mail coupon
 for your copy.

ANACONDA WIRE & CABLE COMPANY
 Magnet Wire Headquarters,
 Muskegon, Michigan.
 Please send me catalog D-95A on
 Analac ready-to-solder magnet wire.

NAME & TITLE.....
 COMPANY.....
 ADDRESS.....
 CITY, ZONE, STATE.....

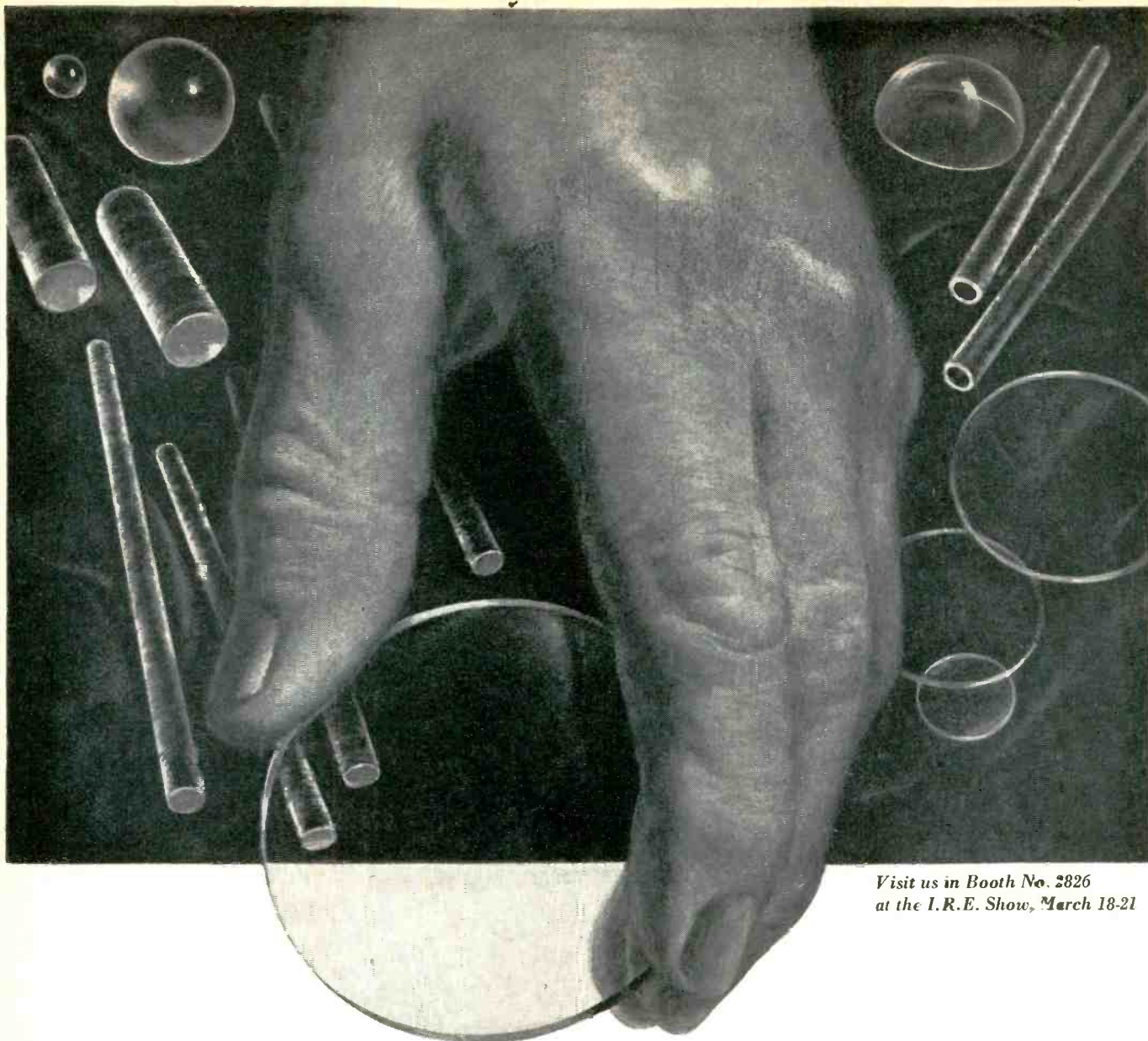

Visit us in Booth No. 2826
at the I.R.E. Show, March 18-21

LINDE SAPPHIRE...

SHAPED TO YOUR NEEDS

Single-crystal sapphire is produced by LINDE in many shapes for a wide variety of applications. Common shapes include windows, balls, rods, and tubes. Special shapes are supplied to order.

LINDE sapphire is transparent, non-porous, and has excellent ultra-violet and infra-red transmission characteristics. Infra-red transmission is 92% at 3 microns, 50% at 6 microns

(1 mm thickness). Typical uses are as windows, spacers, and supports in electronic tubes; for light pipes; and for ultra-violet and infra-red devices. High- and low-temperature seals can be made to metals as well as to glass and ceramics. Inquiries regarding mechanical, optical, thermal, and electrical properties of LINDE sapphire are invited. Write Crystal Products, Dept. BD-3.



LINDE AIR PRODUCTS COMPANY

A Division of Union Carbide and Carbon Corporation

30 East 42nd Street  New York 17, New York

In Canada: Linde Air Products Company, Division of Union Carbide Canada Limited, Toronto

The term "Linde" is a registered trade-mark of Union Carbide and Carbon Corporation.

four good reasons for specifying

ALSiMAG[®] alumina ceramics!

1 Highly specialized compositions. Complete range of industry-approved ALSiMag Aluminas for exacting applications. New freedom in design from their outstanding performance at elevated temperatures and frequencies . . . superior electrical characteristics . . . higher compressive, tensile and flexural strengths . . . hardness (9 on Mohs' scale) . . . chemical inertness . . . greater resistance to impact, vibration, abrasion and repeated thermal shock. Custom formulations for special needs.

2 More production facilities. Complete manufacturing facilities devoted exclusively to ALSiMag Aluminas, including special high temperature kilns. Rapid delivery in any quantity . . . simplest to most intricate designs. Precision tolerances.

3 More experience. ALSiMag Aluminas are produced by skilled personnel, thoroughly familiar with the most modern methods . . . and highly specialized techniques perfected in over 55 years' experience in the manufacture of quality technical ceramics.

4 Dependable metal-ceramic combinations. Standard or custom designs available in volume. Wide choice of metals combined with strong, rugged Alumina ceramics. Permanent bonding. Close dimensional tolerances. High or low temperature types . . . for hard or soft solder.

For complete information on ALSiMag Aluminas, for your application, send blueprint or sketch with details of your operating procedure.



Ask for a free copy of Bulletin No. 562—ALSiMag Alumina Ceramics.

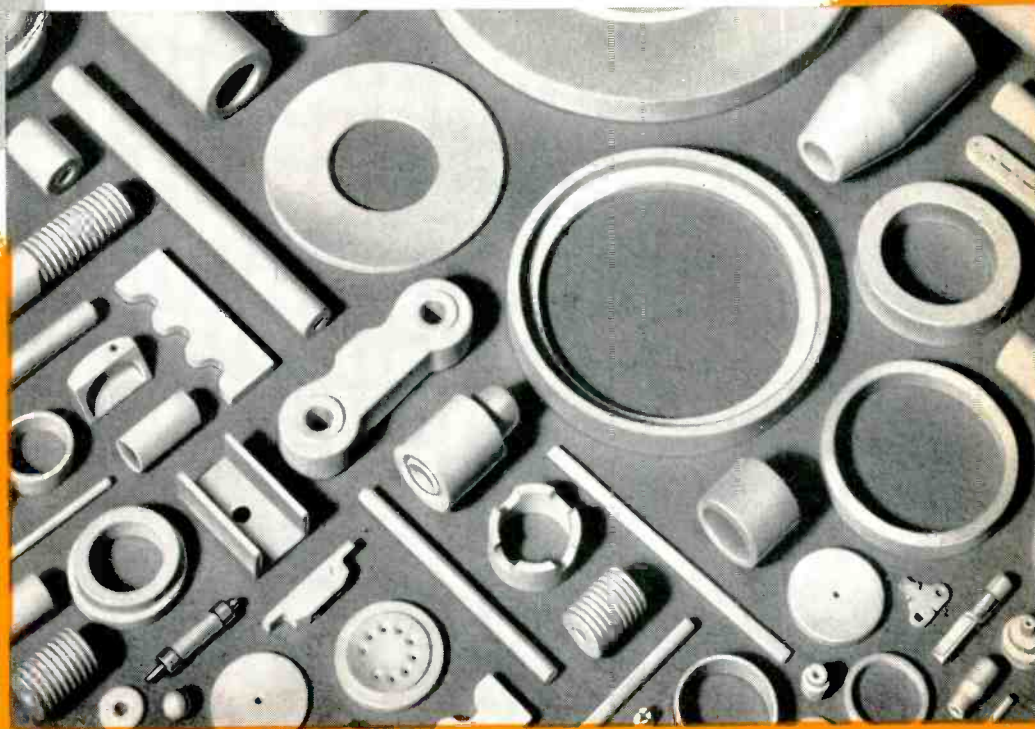

AMERICAN LAVA

A SUBSIDIARY OF
MINNESOTA MINING AND
MANUFACTURING COMPANY



CORPORATION CHATTANOOGA 5, TENN.

55TH YEAR OF CERAMIC LEADERSHIP

For service, contact Minnesota Mining & Manufacturing Co. Offices in these cities (see your local telephone directory): Atlanta, Ga. • Boston, Newton Center, Mass. • Buffalo, N. Y. • Chicago, Ill. • Cincinnati, O. • Cleveland, O. • Dallas, Texas • Detroit, Mich. • High Point, N. C. • Los Angeles, Calif. • New York, Ridgefield, N. J. • Philadelphia, Pa. • Pittsburg, Pa. • St. Louis, Mo. • St. Paul, Minn. • San Francisco, Calif. • Seattle, Wash. Canada: Minnesota Mining & Manufacturing of Canada, Ltd., P. O. Box 757, London, Ont. All other export: Minnesota Mining & Manufacturing Co., International Div., 99 Park Ave., New York, N. Y.

A
NEW
NAME

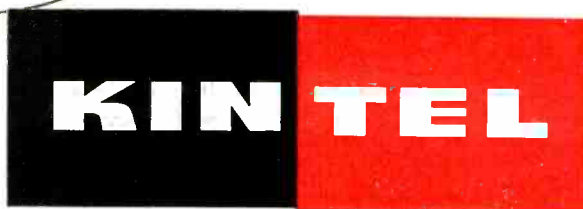

for **KAY LAB** products



The same company, the same engineering and manufacturing facilities, the same world-wide staff of field engineers, but a new name more descriptive of the Company and its products.

LOOK FOR **KINTEL** ON:



UNIVERSAL DC MICROVOLTMETERS

INDUSTRIAL TELEVISION EQUIPMENT

MICROVOLT LEVEL BROADBAND DC AMPLIFIERS

BROADCAST TELEVISION EQUIPMENT

ABSOLUTE DC POWER SUPPLIES AND METER CALIBRATORS

On these and many other electronic products the name **KINTEL** means outstanding instruments and television equipment.



Representatives in all major cities

Write, wire, phone today for demonstration

ELECTRONICS FOR COMMUNICATION • MEASUREMENT • CONTROL

5725 KEARNY VILLA ROAD • SAN DIEGO 11, CALIFORNIA • BROWNING 7-6700

KINTEL

[KAY LAB]

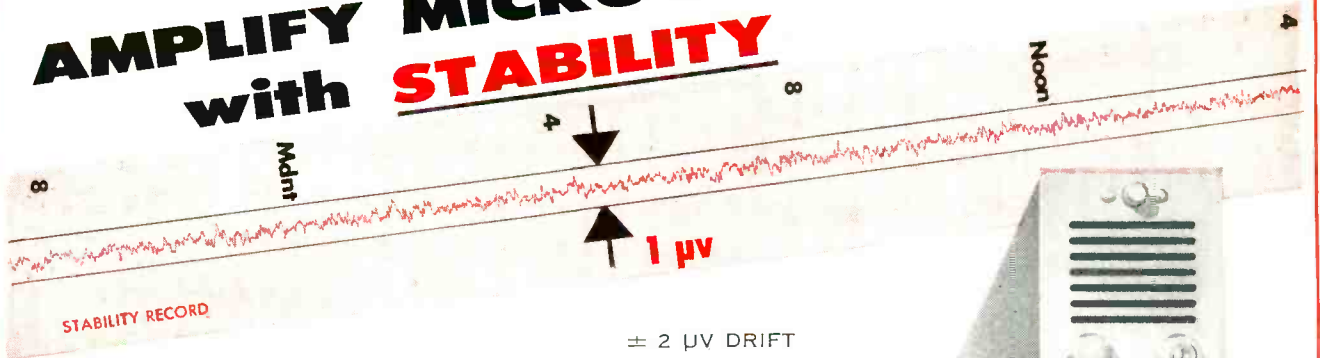
FOR DRIFT-FREE DC INSTRUMENTATION**AMPLIFY MICROVOLTS
with STABILITY**

± 2 μV DRIFT

INTEGRAL POWER SUPPLY

HIGH OUTPUT LEVEL

EXTREMELY LOW NOISE

BROAD BANDWIDTH

10 ACCURATE GAIN RANGES

HIGH INPUT IMPEDANCE

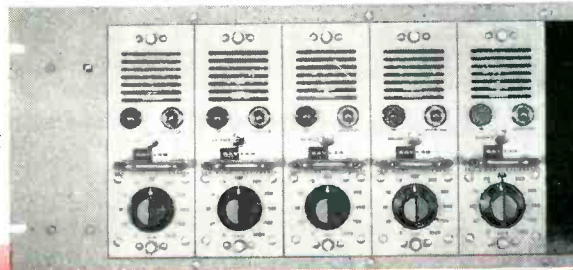

The KINTEL Model 111 amplifier provides maximum stability and the lowest drift of any commercially available broadband d-c amplifier. It is the end result of years of research in the field of chopper stabilized broadband d-c amplifiers. Thousands of KINTEL amplifiers are in daily use. The Model 111 incorporates KINTEL's proven chopper amplifier circuitry and provides ten extremely precise, feedback controlled gain ranges. Several feedback loops assure high accuracy, stability and uniform frequency response. The completely new and unique circuit provides rapid recovery from severe overloading and unsurpassed dynamic performance—unaffected by load or gain changes.

The Model 111 is available in a single-unit cabinet or in a six-unit rack-mountable module. The amplifiers are extremely compact; the six-unit module occupies only a 19-inch rack width.

APPLICATIONS: The Model 111 is ideal for permanent low level d-c instrumentation, telemetering, or as a strain gage amplifier, transducer amplifier, scope preamplifier, recorder driver amplifier, or general purpose laboratory amplifier.

SPECIFICATIONS

Gain	0, 20, 30, 50, 70, 100, 200, 300, 500, 700, 1000
Gain Accuracy	± 1% DC to 2 KC
Input Impedance	100,000 Ω
Output Capability at DC	0 to ± 35 V where $R_L > 1000 \Omega$ 0 to ± 40 MA where R_L is 10 to 400 Ω
Output Impedance	Less than 1 Ω in series with 25 μh
Equivalent Input Drift	± 2 μv with regulated line
Equivalent Input Noise	0 to 3 cps, less than 5 μv peak to peak 0 to 750 cps, less than 5 μv RMS 0 to 50 kc, less than 12 μv RMS
Chopper Intermodulation	Less than 0.1%
Linearity	Better than 0.1% to 2 KC
Frequency Response	± 3% (0.3 db) DC to 10 KC, less than 3 db down at 40 KC

Power Requirements:

Amplifier	117 V — 60 cycles — 70 VA
Cabinet	117 V — 60 cycles — 15 VA
6 Unit Rack Adaptor	117 V — 60 cycles — 45 VA

Dimensions: Amplifier Unit . . . 27⁵/₈" wide, 7⁵/₈" high, 14⁵/₈" deepRack Adaptor for 6 Units . . . 19" wide, 8³/₄" high, 18¹/₄" deep

Net Weight — Amplifier . . . 11 pounds

PRICE: Amplifier Unit . . . \$550.00

19-inch Rack Adaptor for 6 amplifier (with fans and connectors) . . . 200.00

Cabinet for single amplifier (with fan and connector) is available.

...the Standard in chopper-stabilized instruments

KINTEL

[KAY LAB]

Representatives in all major cities.

5725 KEARNY VILLA ROAD, SAN DIEGO 11, CALIFORNIA · BROWNING 7-6700.

STABILITY*Locked in!*

WITH CHOPPER AMPLIFIERS



If it's worth Engineers' time . . .



. . . It's worth Engineered Cable

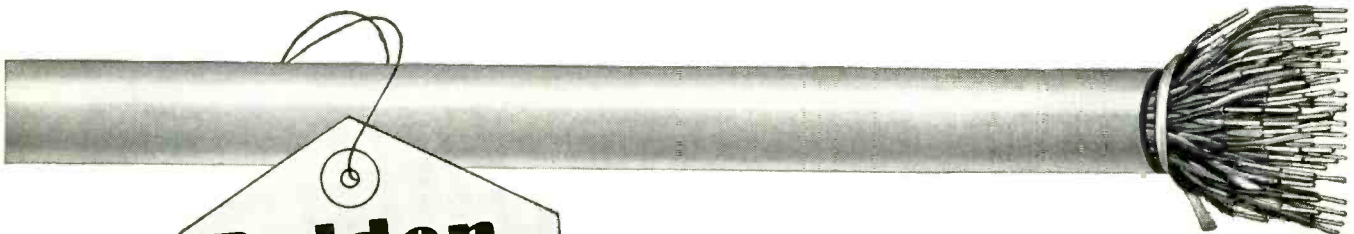

Belden
 INTERCOMMUNICATING
 AND
 SOUND SYSTEM CABLES

Indoor-outdoor, phones
 or speakers—there is a
 Belden engineered cable
 to meet your needs for
 a permanent, trouble-
 free installation.

"Items from the
 Complete Belden Line"

*Intercommunications systems in
 the Statler Hilton in Dallas,
 and other leading hotels
 with intercommunications
 systems, are wired by Belden.*

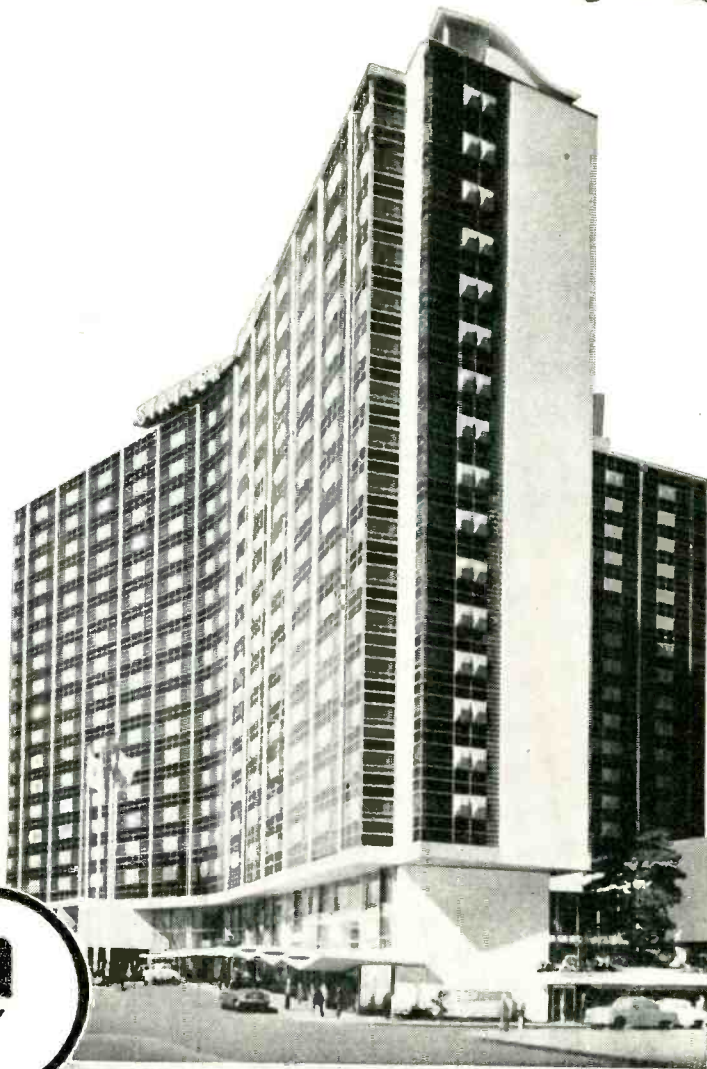

Belden
 WIREMAKER FOR INDUSTRY
 SINCE 1902
 CHICAGO

10-8

Magnet Wire • Lead and Fixture Wire • Power Supply Cords, Cord Sets and Portable Cord • Aircraft Wires
 Welding Cable • Electrical Household Cords • Electronic Wires • Automotive Wire and Cable

SEMICONDUCTORS

BY
GENERAL



ELECTRIC

SILICON * GERMANIUM

RECTIFIERS

FOR ALL ELECTRICAL
CIRCUIT APPLICATIONS

CIRCUIT BREAKER CLOSING
ARC FURNACES

D-C MOTOR ARMATURE SUPPLIES

CATHODIC PROTECTION

MERCURY ARC RECTIFIER
EXCITATION SUPPLIES

HIGH VOLTAGE TRANSMITTER
PLATE SUPPLIES

AIRCRAFT POWER SUPPLIES

WELDING EQUIPMENT

MAGNETIC CLUTCH EXCITATION

AND MANY, MANY OTHERS . . .

TRANSISTORS

FOR ALL MARKETS IN
THE ELECTRONICS INDUSTRY

ENTERTAINMENT

INDUSTRIAL

COMPUTER

MILITARY



MORE THAN 50 TRANSISTORS

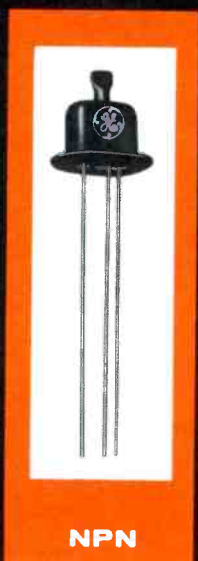
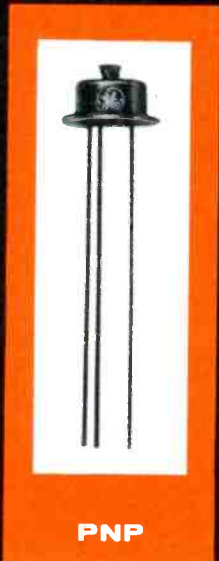

GERMANIUM

ENTERTAINMENT

AUDIO PNP

2N186
2N186A
2N187
2N187A
2N188
2N188A
2N190
2N191
2N192
2N241
2N241A
2N265

2N319
2N320
2N322
2N323
2N324

*For new PNP
†For new PNP

IF NPN

2N168A
2N169
2N169A
2N292
2N293

2N164A
2N165
2N313
2N314

TETRODE NPN

3N31 (formerly ZJ-7-3)

AUDIO PNP

2N43
2N43A
4JD1A17
2N44
2N45

COMPUTER PNP

2N123

2N123

COMPUTER NPN

2N78
2N167

SYMMETRICAL SWITCHING PNP
(Formerly called Bilateral ZJ-20)

4JD1B3
4JD1B4

TETRODE NPN

3N29
3N30
3N31

HIGH FREQ. AMPLIFIER NPN

2N78

COMPUTER (TRADIC) NPN
DCTL
(Formerly ZJ-12)

4JD4A3

HIGH FREQ. AMPLIFIER NPN
(Formerly ZJ-12)

4JD4A2
4JD4A4
4JD4A5

UNIUNCTION
(Formerly ZJ-14 Double Base Diode)

4JD5A1

SILICON

**INDUSTRIAL
COMPUTER
MILITARY**

FOLD OUT OPPOSITE PAGE FOR G-E RECTIFIER INFORMATION



TRANSISTORS

The specification and rating data presented on the five preceding pages have been condensed to cover but a few basic design requirements. Detailed information concerning General Electric's full line of transistors and rectifiers may be obtained by contacting your nearest G-E Semiconductor Products district representative or by writing to:

GENERAL ELECTRIC COMPANY
Semiconductor Products Department
Electronics Park, Syracuse, New York

When writing for information, please specify by publication numbers the material desired.

TYPES	PUBLICATION NUMBERS	TYPES	PUBLICATION NUMBERS
ENTERTAINMENT		ENTERTAINMENT	
2N186 thru 2N192 (PNP)	ECG-144	2N165 (NPN)	ECG-197
2N241A (PNP)	ECG-170	2N313 and 2N314 (NPN)	ECG-198
2N265 (PNP)	ECG-171	INDUSTRIAL/COMPUTER/MILITARY	
2N319 (PNP)	ECG-206	2N43 (PNP)	ECG-20B
2N320 (PNP)	ECG-207	2N43A (PNP)	ECG-76
2N321 (PNP)	ECG-208	4JD1A17 (PNP)	ECG-117
2N322 (PNP)	ECG-209	2N44 (PNP)	ECG-21B
2N323 (PNP)	ECG-210	2N45 (PNP)	ECG-22B
2N324 (PNP)	ECG-211	2N123 (PNP)	ECG-100
2N168A (NPN)	ECG-190	2N167 (NPN)	ECG-119
2N169A (NPN)	ECG-191	2N78 (NPN)	ECG-78A
2N292 and 2N293 (NPN)	ECG-192	Symmetrical Switching Transistor (PNP)	ECG-204
2N164A (NPN)	ECG-196		

RECTIFIERS

Germanium Diffused Junction	ECG-59	Germanium Medium Current	ECG-152
Germanium Stacks	ECG-53B	Silicon Low Current	ECG-134A
Germanium High Temperature and Magnetic Amplifier	ECG-131	Silicon High Current	ECG-166A



TRANSISTOR MANUAL HAS THE FULL STORY

What they are—How they work—Where they are used

- **Principle of Semiconductors** . . . how electrons move through the transistor, and how the movement is directed.
- **How Transistors Are Constructed** . . . telling the methods for producing all known types—and how they are biased.
- **Transistor Applications** . . . describes the circuit design, and transistor function of each design.
- **Specifications on G-E Transistors** . . . complete specs on all G-E types, with chart explaining parameter symbols.
- **Registered RETMA Transistor Types** . . . Tabulation of all transistors now registered with RETMA, with information on each and cross-referenced to General Electric types.
- **Transistor Circuit Diagrams** . . . carefully selected circuits for typical transistor applications—from simple to complex.
- **Cross-Reference Chart for Transistorized Radios.**

Price is only 50¢. Obtain from your local G-E Tube Distributor or from General Electric Co., Semiconductor Products, Electronics Park, Syracuse, N. Y.

THE MAN TO KNOW: YOUR NEAREST G-E SEMICONDUCTOR PRODUCTS REPRESENTATIVE

District 1

F. L. VAN POPPELEN, JR.
GENERAL ELECTRIC CO.
385 CONCORD AVE.
BELMONT, MASS.
VANHOE 4-7670

District 2

CHRISTIAN J. GOODMAN
GENERAL ELECTRIC CO.
200 MAIN AVE.
CLIFTON, N. J.
GREGORY 3-6387
WISCONSIN 7-4065

District 3

H. S. BERCK
GENERAL ELECTRIC CO.
200 MAIN AVE.
CLIFTON, N. J.
GREGORY 3-6387
WISCONSIN 7-4065

District 4

ALBERT C. OEINCK
GENERAL ELECTRIC CO.
2111 SO. GREEN ROAD
CLEVELAND 21, OHIO
EVERGREEN 2-0680

District 5

HARVEY F. HODSDON
GENERAL ELECTRIC CO.
4927 OAKTON STREET
SKOKIE, ILLINOIS
IRVING 8-8668

District 6

VINCENT J. HUNTOON
GENERAL ELECTRIC CO.
4927 OAKTON STREET
SKOKIE, ILLINOIS
IRVING 8-8668

District 7

H. WARD GEBHARDT, JR.
GENERAL ELECTRIC CO.
1434 WESTWOOD BLVD.
LOS ANGELES, CALIF.
BRADSHAW 2-7322
GRANITE 8-8312

District 8

A. B. DALL
GENERAL ELECTRIC CO.
200 MAIN AVE.
CLIFTON, N. J.
GREGORY 3-6387
WISCONSIN 7-4065

District 9

L. A. MOONEY
GENERAL ELECTRIC CO.
4927 OAKTON STREET
SKOKIE, ILLINOIS
IRVING 8-8668

GENERAL ELECTRIC

AS YOUR RECTIFIER NEEDS GROW... SO GROWS G.E.'s LINE OF RECTIFIERS

MORE POWER • HIGHER TEMPERATURE RATINGS • MILITARY APPROVED DEVICES

GERMANIUM JUNCTION RECTIFIERS

1N90 SERIES

The G-E types 1N91, 1N92 and 1N93 rectifiers employ the alloy principle for creating P-N junctions, a process developed by General Electric. High reliability is maintained by an all-welded, hermetically-sealed construction. The 1N93 is the commercial version of the G-E U. S. Navy approved USN-1N93 rectifier.



1N150 SERIES

The G-E 1N90 series rectifiers are single-cell units. The ratings of these units can be increased up to 5 times by the addition of a single copper fin. Single-fin rectifiers are represented by the General Electric types 1N151, 1N152 and 1N153. A two-fin rectifier—type 1N158—provides for increased voltage and current ratings with higher heat dissipation.

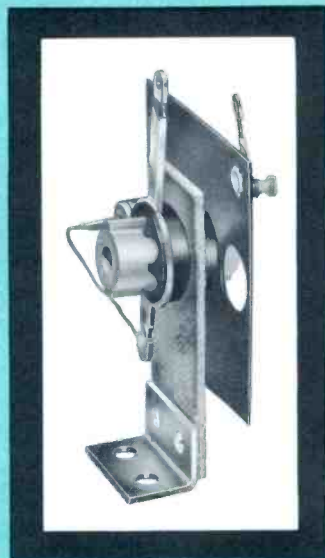

ABSOLUTE MAXIMUM RATINGS (for 60 cycle, 55° C., resistive load)

	1N91	1N92	1N93	1N151	1N152	1N153	1N158
Peak Inverse Voltage	100	200	300	100	200	300	380 volts
D.C Output Current	150	100	75	500	500	500	500 ma
Full Load Voltage Drop	0.5	0.5	0.5	0.7	0.7	0.7	1.4 peak volt
Continuous Reverse Working Voltage	30	65	100	30	65	100	185 volts

GERMANIUM RECTIFIER STACKS

4JA211 SERIES

The G-E 4JA211 finned rectifiers may be arranged in stacks of up to twelve fins to produce over 160 different circuit combinations. Arranged in series or parallel, stacked rectifiers may be operated as half wave, full wave, bridge circuits, and many other types of single or polyphase circuits. A typical rectifier stack rating is listed below.

Note: Standard General Electric rectifier stacks are constructed with a new "ruggedized" mounting bracket which assures a vibration-free installation.

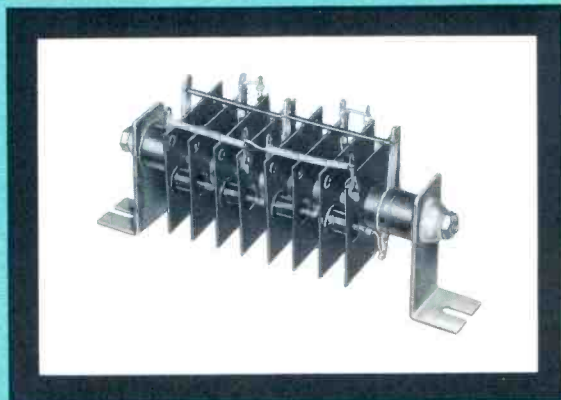

TYPICAL RATING

1 ϕ Bridge 3 amps, 188 V @ 55° C. Free Convection Ambient

GERMANIUM HIGH TEMPERATURE RECTIFIERS

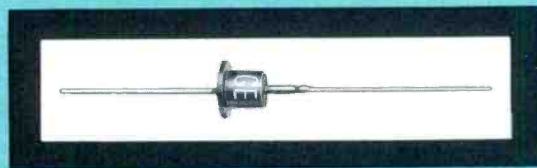

1N315, USAF-1N315, AND 1N368

The G-E Type 1N315 rectifier is specifically designed for high operating temperatures—up to 85° C.—and for low reverse current. This unit is ideal for use in magnetic amplifiers and other circuits where low leakage current is important. The 1N315 is Air Force approved and is supplied to the government per a military specification.

For magnetic amplifier applications, the G-E 1N368 junction rectifier is particularly adaptable. Featuring a very low reverse current at a high d-c reverse voltage, this rectifier is ideal for blocking applications.

SPECIFICATIONS (Resistive or Inductive Load)

	1N315 and USAF-1N315			1N368
	55° C	71° C	85° C	
Max. Allowable Peak Inverse Voltage	300	200	100	200 volts
Max. Allowable D-C Output Current	75	100	100	100 ma
Max. Full Load Forward Voltage Drop	.48	.46	.44	.48 peak volts
Continuous Reverse Working Voltage	150	100	50	150 volts (d-c)
Min. Forward/Reverse Current Ratio (1N315)	700	300	200	
Max. Leakage Current @ -150 V D-C (1N368)				300 μ a

GERMANIUM MEDIUM CURRENT RECTIFIERS

4JA3011 SERIES

The General Electric 4JA3011 Medium Current Rectifier is available in cell PIV ratings of 100, 200 and 300 volts. Its extremely low power dissipation and forward voltage drop provide excellent efficiency and regulation, while its low leakage current meets exacting magnetic amplifier specifications.

G-E medium power rectifiers are available in stacks of up to 12 fins. Stacked in series or parallel, these rectifiers provide ratings in thousands of watts, depending upon the design of the circuit, and operate to over 100° C.

TYPICAL RATING

1 ϕ Bridge 24 amps, 125 V @ 55° C. Free Convection Ambient

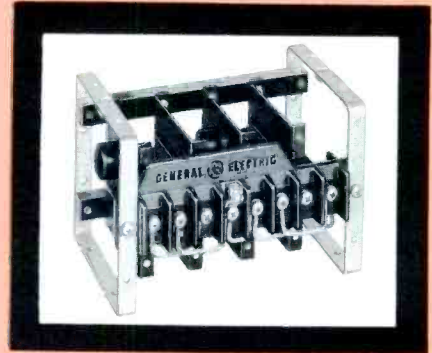

SILICON LOW CURRENT RECTIFIERS



1N536, 1N537, 1N538, 1N539 AND 1N540.

These silicon alloy junction low current rectifiers provide maximum forward conductance at high operating temperatures. A prime feature of the devices is the ability to carry high current loads without the use of any external heat sink. Also, units will solder directly into circuit for machine assembly.

1N536 1N537 1N538 1N539 1N540

Maximum Allowable Peak Inverse Voltage	50	100	200	300	400 volts
Maximum Allowable RMS Voltage	35	70	140	210	280 volts
Maximum Allowable D-C Output Current (at 150° C, ambient)	250	250	250	250	250 ma
Maximum Allowable D-C Output Current (at 50° C, ambient)	750	750	750	750	750 ma

SILICON LOW CURRENT RECTIFIER STACKS

4JA411 SERIES

A combination of high temperature operation (up to 150° C.) and increased power ratings (up to 18 amps) provides General Electric low current silicon rectifier stacks with sufficient circuit versatility to solve just about any rectifier design problem you may encounter. These silicon low current stacks offer the same

Mil-approved bracket construction as our "ruggedized" germanium low current rectifiers (illustrated on opposite page.)

TYPICAL RATING

1 ϕ Bridge 9 amps, 250 V @ 30° C. Free Convection Ambient

SILICON HIGH CURRENT RECTIFIER

4JA60 SERIES

The 4JA60 is a large area junction silicon rectifier designed for power supply applications requiring d-c outputs as high as 85 amperes per rectifying element at rms input voltage up to 210 volts. A combination of extremely low forward voltage drop, minimum thermal impedance (1° D./watt—junction to stud), and a tapered pipe thread heat sink connection contributes to high allowable current ratings with very little external cooling required.

Versatility is increased by the availability of a negative polarity (stud is anode) unit, which facilitates construction of bridge circuits and permits the use of either a positive or negative heat sink in half-wave and center-tap applications.

RATINGS AND SPECIFICATIONS (Resistive or Inductive Load, 60 cps)

	4JA60C	4JA60B	4JA60A	4JA60F
Maximum Allowable Peak Inverse Voltage	300	200	100	50
Maximum Allowable Rms Voltage	210	140	70	35
Maximum Allowable Forward Current . . . Depends on study temperature. See curves reverse side.				
Maximum Allowable One Cycle Surge Current . . . 900 amperes.				
Reverse Current . . . 50 ma @ max. PIV, 200° C junction temperature.				
Operating Temperature . . . -65° C to +200° C (Limited by junction temperature of 200° C).				
Storage Temperature . . . -65° C to +200° C.				
All General Electric silicon rectifiers will meet rigid military mechanical specifications.				



SILICON HIGH CURRENT RECTIFIER STACKS

4JA6011 SERIES By stacking the General Electric Type 4JA60 rectifiers, a device is created which will provide you with just about the best power-, inch-, pound-dollar values you'll find anywhere. These 4JA6011 series high current silicon rectifier stacks are small, lightweight, and powerful enough to give you an output of 76.5 kilowatts—without forced air cooling—from a volume of less than 1/3 of a cubic foot.

TYPICAL RATING

3 ϕ Bridge 270 amps, 283 V @ 35° C. Free Convection Ambient



NEW POWER * UNIFORMITY PACKAGE DESIGN * *

Silicon high frequency transistors for DCTL switching applications and linear amplifiers up to 5 mc. Silicon unijunction transistors for bistable and monostable applications — can replace two transistors in many circuits. Symmetrical switching transistors — 200 mw dissipation, controlled forward and inverse current gain — will efficiently switch large currents at high speeds.

More than 50 G-E transistor types to cover just about every application requirement. Nearly all G-E transistors are presented on this page — a line of devices that offers you the very latest in internal design and packaging techniques. Increased power, higher frequency and tightly controlled parameters for maximum circuit utility, make your selection of General Electric transistors a wise choice.

New G-E transistor cases eliminate tubulation and flange, for greater compactivity. The new NPN package lead arrangement provides for printed circuit plug-in use.

MAXIMUM RATINGS

TYPICAL VALUES

Maximum Collector Dissipation @ 25° C (mw) P_C	Breakdown Voltage Collector To Emitter (volts) V_{CE}	Collector Current (ma) I_C	Maximum Junction Temp. (° C) T_j	D-C Current Gain h_{FE}	Alpha Cutoff Freq. (mc) $F_{\alpha b}$	Power Gain (db) G_e	Class B Power Output (mw) P_o	Collector Capacity ($\mu\mu f$) C_{ob}	Collector To Base Current $I_{CO} @ V_{CB}$	
75	-25	-200	85	24	.8	28	300	35	16	25
180	-25	-200	85	24	.8	28	750	35	16	25
75	-25	-200	85	36	1	30	300	35	16	25
180*	-25*	-200	85	36	1*	30	750	35	16	25
75	-25	-200	85	54	1.2	32	300	25	16	25
180*	-25*	-200	85	54	1.2*	32	750	35	16	25
75	-25†	-50	85	36	1*	39		35	16	25
75	-25†	-50	85	54	1.2*	41		35	16	25
75	-25†	-50	85	75	1.5*	43		35	16	25
100	-25	-200	85	73	1.3	35	300	35	16	25
180*	-25*	-200	85	73	1.3*	35	750	35	16	25
75	-25	-50	85	110	1.3	43		35	16	25
*200	*20				*3 _{mc}					
	†-16									
							Freq. of G_e			
65	15	20	85	40	8	30	455 kc	2.4	5	15
55	15	20	75	72	4	26	455 kc	2.4	5	15
55	25	20	75	72	5	26	455 kc	2.4	5	15
65	15	20	85	25	5	26	455 kc	2.4	5	15
65	15	20	85	25	8	30	455 kc	2.4	5	15
50	7 V_{CB}	20	85		15		15 mc	3.1	25	7
150	-20	-50	100	50	1		1 kc	40	15	45
150	-20	-50	100	50	1		1 kc	40	15	45
150	-20	-50	85	40	1		1 kc	40	16	45
150	-20	-50	100	22	1		1 kc	40	15	45
150	-20	-50	100	12	1		1 kc	40	15	45
100	-15	-125	85	50	8			15		
65	15	20	85	40	8		500 kc	2.4	5	15
65	30	75	85	36	8			4	1.5	15
200	-30	1A	85	15-15	.8			45	20	30
200	-30	1A	85	20-20	.8			45	20	30
50	7 V_{CB}	20	85		40	10 G_b	30 mc	4.2	25	7
50	7 V_{CB}	20	85		80	10 G_b	120 mc	5	25	7
50	7 V_{CB}	20	85		20	10 G_b	15 mc	3.1	25	7
65	15	20	85	40	8	30	500 kc	2.4	5	15
150	10	20	150		25			14	.15	5
150	15	20	150	14	25	15	5 mc	14	.15	5
150	15	20	150	15	25	33	1 kc	14	.15	5
150	15	20	150	40	25	36	1 kc	14	.15	5
P_{BB}	V_{BB}	I_E	T_j			$\frac{V_{B2}}{V_P}$			I_{EO}	
250	45	50	150			2			50	45



FOLD OUT PAGE FOR G-E RECTIFIERS



COMPUTERS AND PROCESS CONTROL discussed by *Eric Weiss*

The application of digital computers to the direct control of processes brings up these two questions: (1) Can the control functions be properly formulated? (2) Can computers be made reliable enough?

Speed is no problem. Today's memory developments offer practically instantaneous access. A 50 kc or 100 kc serial computer is fast enough to satisfy most control operations. When this is not fast enough, the overall speed can easily be increased one or two orders of magnitude through the use of a parallel machine.

There is another way of speeding up a computer. Rather than build a general purpose machine which can compute any problem we like to code into it, special purpose computers can be designed and built for special jobs. The same proven elements would be utilized, but would be arranged in different arrays in order to come up faster and more directly with the desired solution. The resulting machine would most likely do the job faster without actually increasing the repetition rate.

The problem of reliability is not so easily disposed of. In the past, digital computers were primarily used as mathematical tools to compute lengthy mathematical problems or to process repetitive data. If a computer made an error once every billion operations (which at the rate of 100kc would be every three hours), it was not too serious. The error was caught and the problem, at the worst, computed again.

The moment we start thinking about a computer in direct control applications, the problem becomes more critical. If the computer controls some sort of manufacturing or chemical process, a single error at the wrong time in the wrong spot can be catastrophic. Under such circumstances, an error probability of 1 in a billion cannot be tolerated. An almost errorless operation is required.

Most digital computers presently in production have a large number of hot vacuum tubes. These are the least reliable elements in a computer. Their filaments burn out; envelopes leak; or various fragile elements short.

During the last decade, a series of solid state elements has been developed which make it feasible to build a computer without vacuum tubes or moving elements. The diode, the transistor, the magnetic amplifier, the magnetic core and several other elements in this class can be expected, unless abused, to live and operate without mistakes practically indefinitely. Furthermore, they are considerably smaller, lighter, and less power consuming.

Consider a flip-flop, for example. Utilizing vacuum tubes, a flip-flop consists of at least a double triode, several crystal diodes, resistors, capacitors, plus the necessary hard-



Eric Weiss, nationally-recognized authority on computer philosophy and design, discusses the use of digital computers in process control.

ware to mount the same. Such an assembly normally occupied the same space as a king-size package of cigarettes, and the required accessory equipment, such as power supply or air conditioning, occupied a similar space. In contrast, a transistor flip-flop could be packaged in a volume of the size of a peanut shell with the corresponding power supply even less. The power consumption is so minute that the unit can be potted and it is quite likely in the near future a whole computer could be potted.

The major obstacle to the use of computers in control applications is the lack of understanding of the processes which are to be controlled. A scientist can play with a general purpose computer in a control system. He can code it by trial and error. Once the formulae have been determined, a special purpose computer that would be smaller, faster, and more efficient, can be built to control the process.

By applying the latest proven techniques, our well-qualified staff at Daystrom Systems is prepared to take single responsibility of assembling and installing a system to meet your needs. We are currently compiling a file of new applications and papers on various parts of systems, both industrial and military. If you are interested in receiving the file and periodic additions, please write us.

DAYSTROM SYSTEMS
DIVISION OF DAYSTROM, INC.
5640 LA JOLLA BOULEVARD
LA JOLLA, CALIF., GL 4-0421

HUBBELL Interlock PLUGS

TRADE MARK



Stay Locked IN ACTION!

Won't Disconnect Accidentally . . .

Yet Disconnect Quickly When Intended

Today's engineers ask more of the connectors they use than simply that they make contact. Computers and modern, automatic machinery require *constant, positive* connections . . . aircraft wiring must be vibration proof and unaffected by temperature changes . . . printed circuits need sub-miniature connectors that will remain fixed. Hubbell *Interlock* Connectors are designed with all these features — and more! Whether they're used for connecting wire to wire, wires to panels, or wires to terminal strips, the combination of *Interlock* plugs and eyelets or plugs and jacks provides *automatic locking*, *quick disconnect* wiring that assures constant low contact resistance. Contact is maintained by a coil spring that adjusts for temperature and pressure changes and is part of the disconnect mechanism that permits fast rearrangement of circuitry and ease of maintenance.

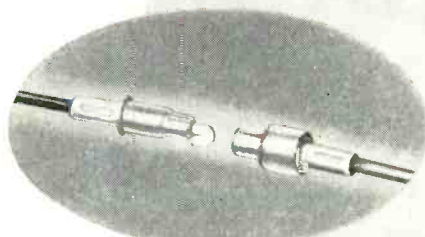



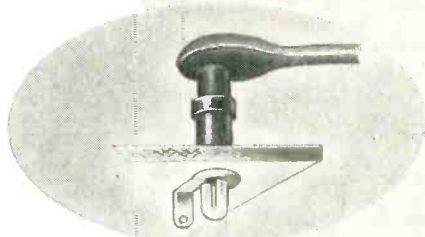

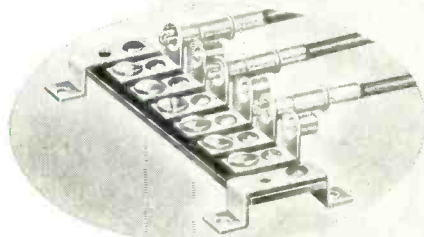

Wire to Wire



Wire to Panel



Wire to Terminal Strip

 <p>TYPE "A" PLUGS, JACKS AND EYELETS Nylon Insulated and Non-Insulated. Current Capacity: 10 amps. Wire Sizes: #14 to #18</p>	 <p>TYPE "B" PLUGS AND JACKS Nylon Insulated and Non-Insulated. Current Capacity: 5 amps. Wire Sizes: #18 to #22</p>
 <p>TYPE "A" ANGLE PLUGS AND DOUBLE ENDED JUMPER CORDS Current Capacity: 10 amps.</p>	 <p>TYPE "C" SUB-MINIATURE PLUGS AND EYELETS Current Capacity: 1 amp. Wire Sizes: #20 to #22 or smaller</p>
 <p>TYPE "S" PLUGS AND JACKS Nylon Insulated. Current Capacity: 15 amps. Wire Sizes: #14 to #18</p>	 <p>TYPES "A" AND "B" LAMINATED TERMINAL STRIPS AND TYPE "B" FLEXIBLE TERMINAL STRIPS</p>



HARVEY HUBBELL, Inc.

Interlock Electronic Connector Dept.,

Bridgeport 2, Conn.



The HEILAND

Dynamic Recording System gives you more...

- *VERSATILITY*
- *PERFORMANCE*
- *EASE OF OPERATION*

FOR TABLE, MOBILE, OR
RELAY RACK MOUNT

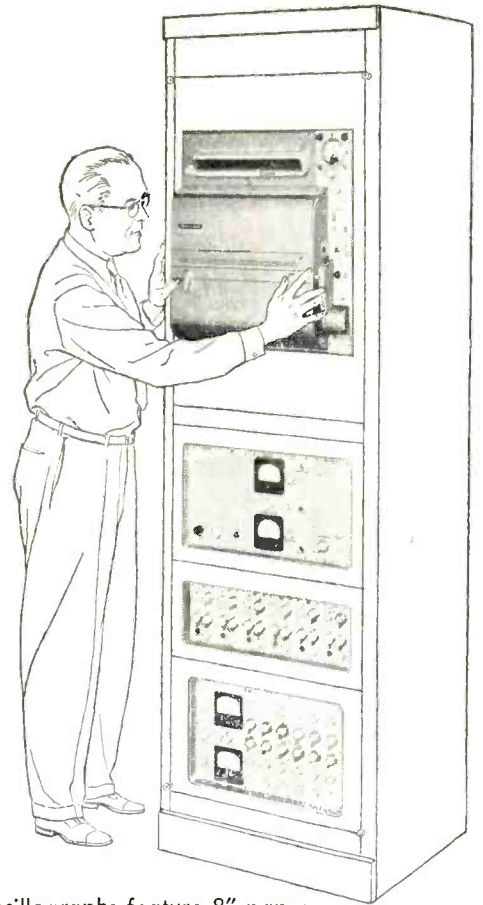

Oscillograph ● The Series 700C oscillographs feature 8" paper width with 1-36 channels, or 12" paper width with 1-60 channels. Available for 23 v.d.c. or 115 v.a.c. operation, the 700C Series has paper speeds adjustable from .030 to 144"/sec., and writing speeds in excess of 20,000"/sec. Separate supply and take-up drums are light-weight—and light tight for easy daylight loading. For details and specifications, write for Bulletin 701-NK.

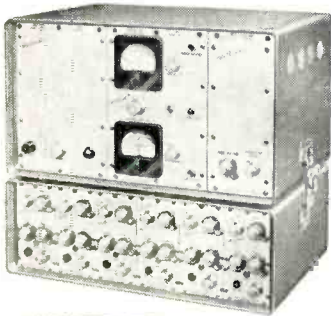

Amplifier ● The Heiland 119 Amplifier System offers up to 6 channels, in any combination, of either linear-integrate amplifiers or carrier amplifiers. Carrier amplifier channels provide linear frequency response from 0 to 1000 CPS, for resistive, linear differential transformer, or variable reluctance type transducer inputs. Linear-integrate amplifier channels provide linear frequency response from 5 to 3000 CPS for self-generating transducers. Provides high-amplitude recording up to 8" peak to peak deflection.

For details and specifications, write for Bulletin 101-NK

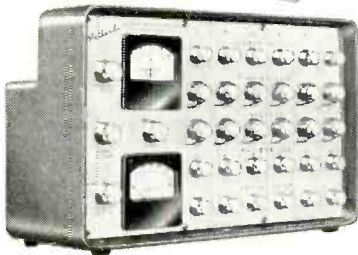

Bridge Balance ● The Heiland 82-6 Bridge Balance and Strain Indicator Unit provides a simple and accurate means of balancing, calibrating and measuring static and dynamic phenomena from resistive-type transducers where you don't need amplification. When used as a strain-indicating device without an oscillograph, an input of 25 microamperes produces full scale on the indicating meter.

For details and specifications, write for Bulletin 101-NK

For versatility, performance, and ease of operation,
choose the Heiland dynamic recording system



MINNEAPOLIS
Honeywell

HEILAND INSTRUMENTS

5200 EAST EVANS AVENUE • DENVER 22, COLORADO

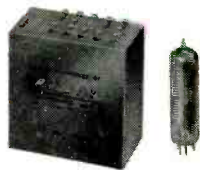

MEET THE
MIGHTY MIDGET
OF AIRCRAFT FIRE POWER

This new **TRANSISTORIZED CONTROL AMPLIFIER** weighs only 11 ounces...but it is a vital control element in the voltage regulation of an entire aircraft fire control system. Developed as part of an integrated power supply, the "MIGHTY MIDGET" operates from -35° to $+125^{\circ}$ C...reduces ripple to less than 50mv peak-to-peak...is adaptable to voltages of ± 50 to ± 1000 ...controls voltage regulation to $\pm 1\%$. Here is another example of Packard Bell's skill in developing lighter, more efficient airborne equipment... another result of more than 30 years of electronic leadership.
See it at the New York IRE SHOW... booths 3705-3707.

PACKARD BELL ELECTRONICS
TECHNICAL PRODUCTS DIVISION
Los Angeles 64, California



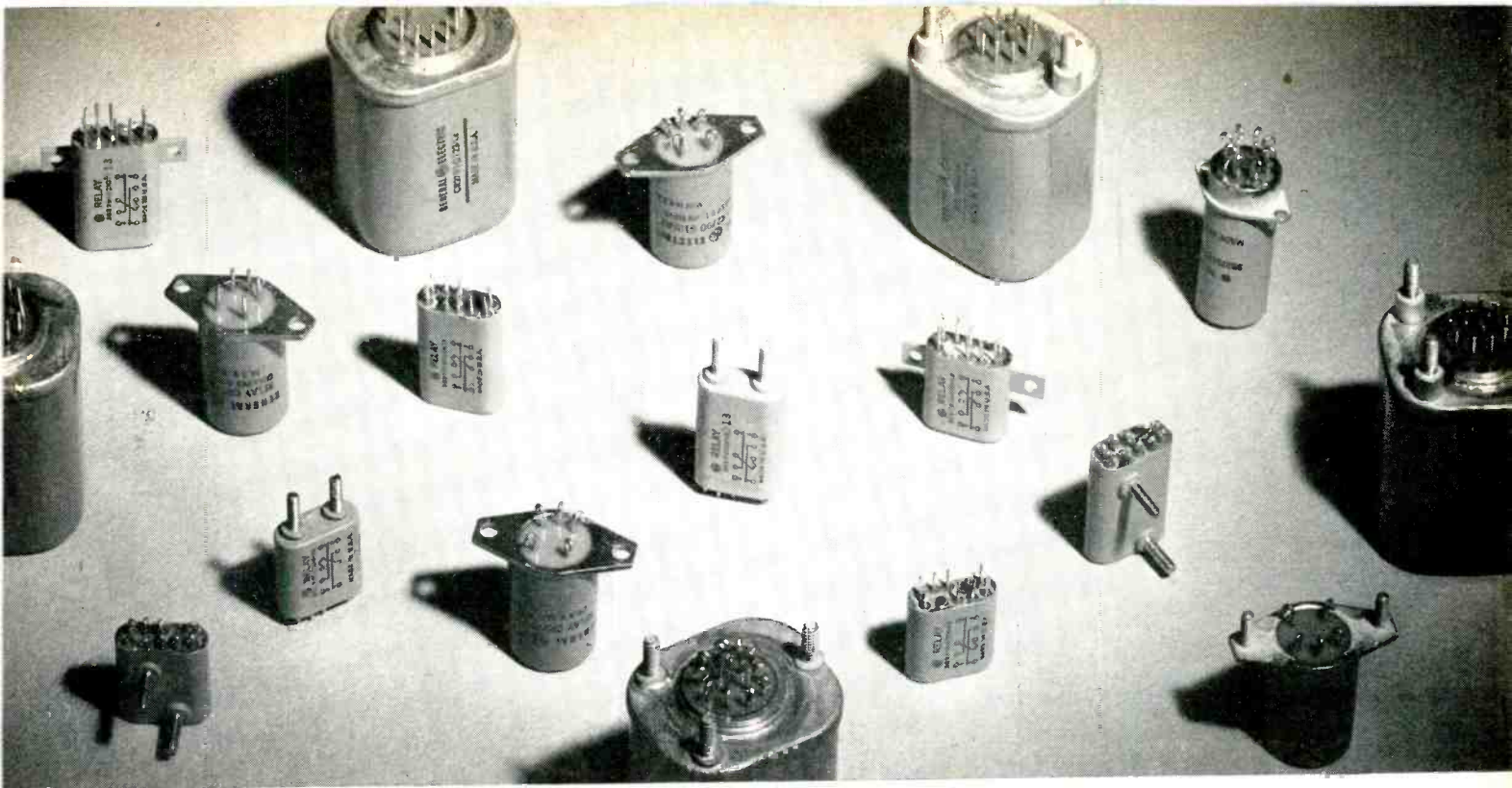

NOW . . . ONLY 3-WEEK SHIPMENT* on General Electric's full-line of sealed relays

Improved production techniques now make it possible for General Electric to offer its complete line of standard-listed hermetically sealed relays—including the amazing micro-miniature—on only 3-week shipment from order date!

And, what's more—General Electric is equipped to provide you rapid service on samples and prototypes.

FOR ALL ELECTRONIC SYSTEMS

G-E miniature, sub-miniature, and micro-miniature relays combine small size with unusual reliability under severe temperature, shock, and vibration conditions—making them ideal for all radio, radar, fire control, navigational equipment, and industrial electronics jobs.

Though initially designed for military applications, more and more G-E sealed relays are being used for industrial jobs. Their extreme reliability and small size now are utilized by industrial designers. Resistance welding and other industrial electronic circuitry is being simplified and miniaturized with G-E sealed relays.

WIDE RANGE OF COIL RATINGS, HEADER TYPES, AND MOUNTINGS

Whatever your small sealed relay needs—you'll find the answer with one of the many forms of these three models:

Miniature: Standard, current-sensitive, and voltage-sensitive models; in 2-, 3-, or 4-pole double-throw and 6-pole normally open forms. Rated 5 amps at 28 volts d-c at 85C. 3-amp make-before-break forms and 125C forms available.

Sub-miniature: 2 amps; .651 in. in diameter, 1.6 in. long; weighs one ounce. Unaffected by vibrations of 10 to 55 cps at .12 in. maximum excursion or 55 to 500 cps at 15Gs acceleration. Withstands shock tests in excess of 40Gs. Operates in ambients of 125C.

Micro-miniature: Weighs only 0.5 oz., measures .36 in. by .80 in. by .88 in. Rated 2 amp resistive at 28 v d-c or 115 v a-c. Also available in current-sensitive models. Standard relays withstand ambients of 125C, and 20Gs acceleration at 50 to 500 cps. *Contact your G-E Apparatus Sales Office, or mail coupon. Specialty Control Dept., Waynesboro, Va.*

*Average shipment time for all standard listed relays. Actual time: **MICRO-MINIATURE** (up to 100 units—2 weeks, 100 to 1000 units—4 weeks); **SUB-MINIATURE** (up to 100 units—3 weeks, 100 to 1000 units—5 weeks); **MINIATURE** (up to 100 units—1-2 weeks, 100 to 1000 units—3 weeks).

MAIL TODAY FOR G-E RELAY DATA

General Electric Co., Sect. A 792-6, Schenectady 5, N. Y.

- Miniature—Bulletin GEA-6213
- 2PDT Sub-miniature—Bulletin 6412
- Micro-miniature—Bulletin 6346
- HAVE G-E SALES ENGINEER CALL

NAME _____
 COMPANY _____
 ADDRESS _____
 CITY _____ STATE _____

GENERAL  ELECTRIC

here...
see
for
yourself



Each pound of reduced weight is worth something to you. The new Bendix Pygmies reduce connector weight drastically. These miniature aluminum connectors are for compact electronic equipment and aircraft use. Contacts are size 20 heavily gold-plated, featuring machined closed entry sockets. Choice of quick disconnect coupling between a modified double stub thread or 3 point bayonet lock. Provisions for grommet sealing, potting, cable sealing, conduit applications.

Bendix "Pygmy" Connectors weigh less, take up less space than Standard AN Connectors. Think of the advantages!

Available in a wide variety of shell styles and insert arrangements. Shell sizes range from $\frac{3}{8}$ " I.D. to $1\frac{3}{4}$ " I.D. and incorporate from 1 to 55 contacts. Write Dept. PC for descriptive literature on this dramatic improvement in Aviation Electronics.

Avnet

AVNET EASTERN SALES, 36 N. MOORE ST., NEW YORK 15, N. Y. BEEKMAN 5-5780 (AVNET ELECTRONIC SUPPLY CO., INC.)
AVNET WESTERN SALES, 8966 NATIONAL BLVD., LOS ANGELES 34, CAL. TEXAS 0-7950, VERMONT 7-1461 (AVNET CORPORATION)

Now!

Vitrohm MIL-R-26C Resistors in all styles!

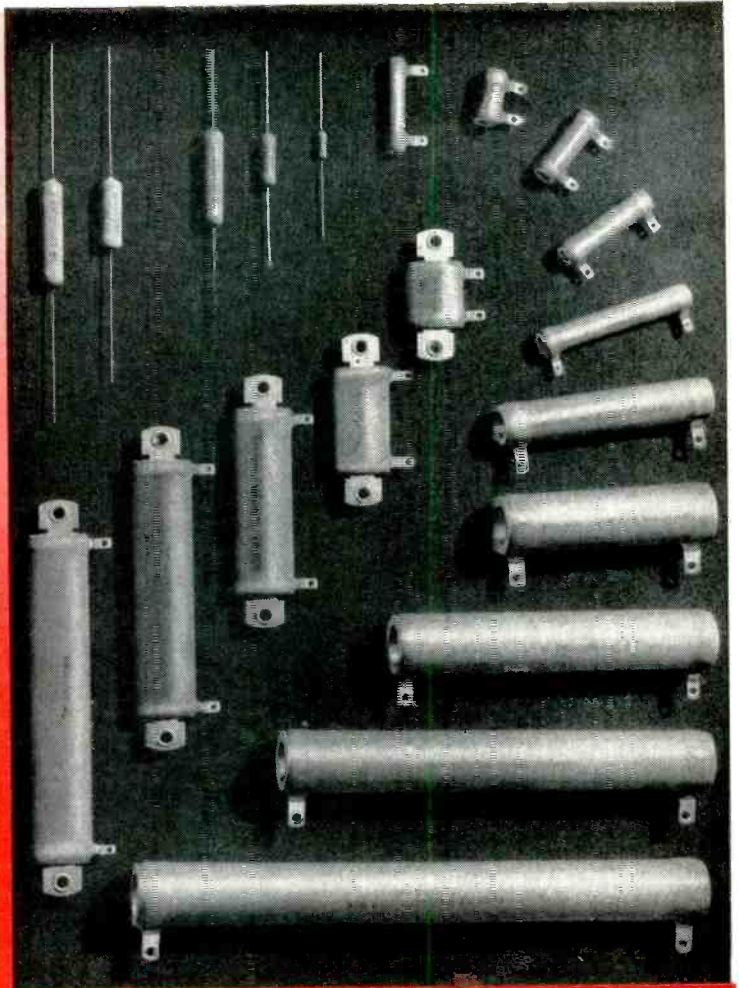

Famous Ward Leonard Vitrohm® vitreous-enameled resistors are now available in every style to meet all requirements of Military Specification MIL-R-26C including the severe bogeys on moisture resistance, thermal shock, insulation resistance and many other properties.

What's more, this line offers you *all* characteristics—G, V, and the exacting Y—and *all* specification sizes and resistance values—even the highest values using the finest wire (0.00175" dia.) permitted by the spec.

Tab-terminal, axial-lead and stack-mounting types are available in styles and characteristics shown in table.

For complete data on these MIL-R-26C resistors, write us for Bulletin 12. (And incidentally, for Vitrohm resistors to *highest commercial and industrial standards*, get W/L Catalog 15.) Ward Leonard Electric Co., 31 South Street, Mount Vernon, N.Y. In Canada: Ward Leonard of Canada Ltd., Toronto.

ENGINEERING DATA

TYPE	STYLE	AVAILABLE IN CHARACTERISTICS	RESISTANCE RANGE
Stack Mtg.—Tab	RW20 thru 24	G	All values in Spec.
Tab terminal	RW29 thru 47	V, Y* and G	All values in Spec.
Axial lead	RW55 thru 59	V and G	All values in Spec.†

*Characteristic Y applies to styles RW30, 33, 37 and 47 only. Characteristic Y is similar to V but requires high insulation resistance at end of moisture-resistance tests.

†Maximum values for single-layer-wound resistors with 0.00175" diameter wire.

LIVE BETTER...Electrically



7.7



**WARD LEONARD
ELECTRIC COMPANY**
MOUNT VERNON, NEW YORK



RESISTORS



POTENTIOMETERS



RELAYS



CONTROLS



POWER SUPPLIES

Result-**E**ngineered Controls Since 1898

What's YOUR Electronic

Solderability?...

Temperature?...

Unusual Shapes?...

Space?...

Here are five proven solutions to

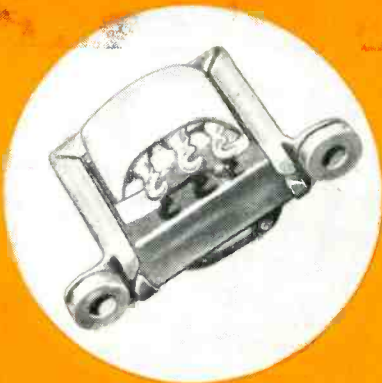

THERMALEZE

A Class "B" 130 C epoxide-polyester film wire for higher temperature windings.

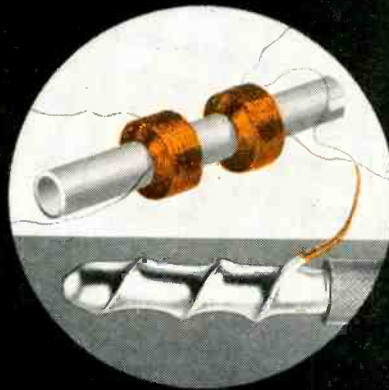

SODEREZE

A polyurethane-coated wire—solders at low temperature—without stripping!



ENAMEL

Modern black enamel with uniform O.D., high tensile for layer-wound coils.

First for Lasting Quality — from Mine to Market!

Visit Our Booth, No. 4516-4518, at the I.R.E. Show, March 18-21

Coil Problem?...

Phelps Dodge can supply the right answer to your particular magnet wire problem from its complete, up-to-date line. The products shown here have varied electronic applications. These magnet wires are the result of Phelps Dodge research and development of new materials, combined with practical experience in application engineering.

The complete line of Phelps Dodge magnet wire includes:

Enamel • Formvar • Sodereze® • Bondeze® • Thermaleze® • Grip-eze® • Sylkyd
Daglas® • Daglas® Silicone • Paper • Cotton • Multiple Combinations

lower-cost electronic coils



BONDEZE

Self-bonding wire for turn-to-turn bonding in unusual shaped coils, bobbinless coils, yoke coils, etc.

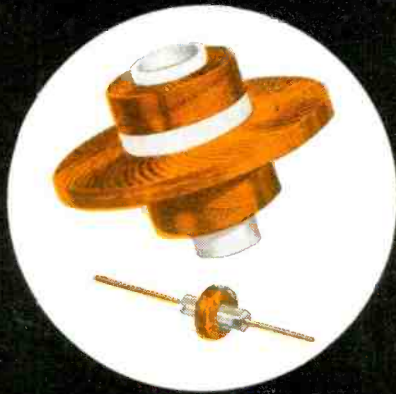

GRIP-EZE

Controlled friction solderable film wire for winding universal lattice-wound coils, fly-back coils, choke coils, etc.



Wire packaged in Phelps Dodge special "Pakeze" containers if required.

Any time magnet wire is your problem, consult Phelps Dodge for the quickest, easiest answer!



PHELPS DODGE COPPER PRODUCTS
CORPORATION

INCA MANUFACTURING DIVISION
FORT WAYNE, INDIANA

NOW: available on a

For engineering evaluation of thermistor and varistor characteristics, you can now obtain any of 37 individual test kits, each containing six pieces. The minimum quantity per order is three kits. Shipment will be made postpaid to any destination in the United States and Canada.

Global THERMISTORS

To evaluate thermistor circuit applications for:

1. Temperature compensation.
2. Time delay.
3. Temperature sensing and control.

Test Kit No.	Type	Body Size		R at 25° C ± 20%	Nom. Temp. Coeff. "B" Constant	Max. Watt Loading at 40° C	Price
		Length	Dia.				
T-1	997F	1 ⁹ / ₆₄ "	7 ¹ / ₆₄ "	40 ohms	1500	0.25	\$3.95
T-2	997F	1 ⁹ / ₆₄ "	7 ¹ / ₆₄ "	220 ohms	1750	0.25	3.95
T-3	997F	1 ⁹ / ₆₄ "	7 ¹ / ₆₄ "	10000 ohms	1950	0.25	3.95
T-4	763F	5 ⁵ / ₈ "	7 ¹ / ₃₂ "	5 ohms	1200	0.5	3.70
T-5	763F	5 ⁵ / ₈ "	7 ¹ / ₃₂ "	10 ohms	1400	0.5	3.70
T-6	763F	5 ⁵ / ₈ "	7 ¹ / ₃₂ "	15 ohms	1500	0.5	3.70
T-7	763F	5 ⁵ / ₈ "	7 ¹ / ₃₂ "	20 ohms	1500	0.5	3.70
T-8	763F	5 ⁵ / ₈ "	7 ¹ / ₃₂ "	120 ohms	1700	0.5	3.70
T-9	763F	5 ⁵ / ₈ "	7 ¹ / ₃₂ "	1000 ohms	1800	0.5	3.70
T-10	763F	5 ⁵ / ₈ "	7 ¹ / ₃₂ "	10000 ohms	2100	0.5	3.70
T-11	763F	5 ⁵ / ₈ "	7 ¹ / ₃₂ "	120000 ohms	2150	0.5	3.70
T-12	763F	5 ⁵ / ₈ "	7 ¹ / ₃₂ "	330000 ohms	2150	0.5	3.70
T-13	416H	1 ¹ / ₆ "	5 ¹ / ₆ "	1200 ohms	3800	0.5	3.95
T-14	479H	1 ¹ / ₈ "	1 ¹ / ₂ "	1000 ohms	3800	1.5	3.95
T-15	373H Metallized Faces Only	1 ¹ / ₈ "	3 ³ / ₄ " o.d. 1 ¹ / ₄ " i.d.	10 ohms	2700	3.5	4.55
T-16	373H Metallized Faces Only	1 ¹ / ₈ "	3 ³ / ₄ " o.d. 1 ¹ / ₄ " i.d.	40 ohms	2700	3.5	4.55
T-17	343H	1 ¹ / ₈ "	3 ³ / ₄ " o.d. 1 ¹ / ₄ " i.d.	5.5 ohms	2700	3.5	4.85
T-18	343H	1 ¹ / ₈ "	3 ³ / ₄ " o.d. 1 ¹ / ₄ " i.d.	20 ohms	2700	3.5	4.85
T-19	549H	3 ³ / ₄ "	7 ¹ / ₆₄ "	5000 ohms	3200	0.75	3.95
T-20	588H	1"	7 ¹ / ₆₄ "	11000 ohms	3200	1.	4.25
T-21	763H	5 ⁵ / ₈ "	7 ¹ / ₃₂ "	500000 ohms	4600	0.5	3.95

Global THERMISTORS

For evaluation of surge current suppression in series filament and pilot light circuits in radio and television receivers.

Test Kit No.	Type	Body Size		R at 25° C ± 30%	Nominal R at 45° C and Rated Current	Price
		Length	Dia.			
T-22	763F	5 ⁵ / ₈ "	7 ¹ / ₃₂ "	145 ohms	40 ohms at 150 m.a.	\$3.70
T-23	759F	3 ³ / ₄ "	1 ¹ / ₄ "	500 ohms	85 ohms at 135 m.a.	3.95
T-24	441F	1 ¹ / ₈ "	3 ³ / ₈ "	880 ohms	100 ohms at 150 m.a.	4.25
T-25	341F	3 ³ / ₄ "	5 ⁵ / ₈ "	375 ohms	40 ohms at 300 m.a.	4.55
T-26	525F	1 ⁷ / ₈ "	1 ¹ / ₂ "	250 ohms	20 ohms at 600 m.a.	4.55
T-27	327F	3 ¹ / ₈ "	1 ¹ / ₂ "	460 ohms	35 ohms at 600 m.a.	4.85
T-28	421F	3 ³ / ₆ "	1" x 1 ¹ / ₈ " Wafer Type	125 ohms	43 ohms at 600 m.a.	5.15
T-14	479H	1 ¹ / ₈ "	1 ¹ / ₂ "	1000 ohms	50 ohms at 150 m.a.	3.95
T-17	343H	1 ¹ / ₈ "	3 ³ / ₄ " o.d. 1 ¹ / ₄ " i.d.	5.5 ohms	.31 ohms at 3.0 amps.	4.85

selective basis...

THERMISTOR AND VARISTOR

Globar[®] TEST KITS

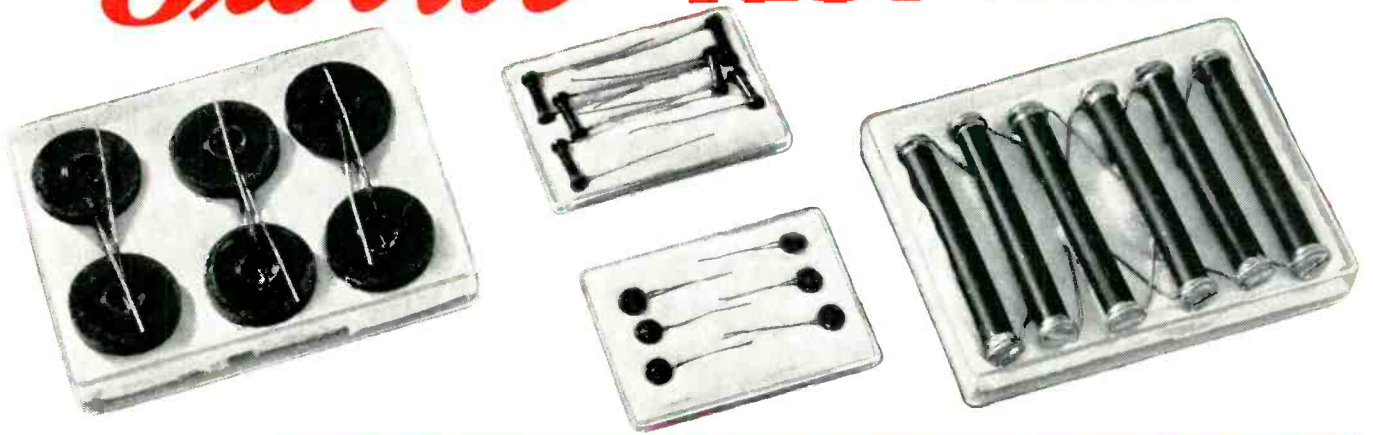

Globar[®] VARISTORS Type BNR

To evaluate varistor circuit applications for:

1. Reduction of surge voltage peaks.
2. Reduction of relay contact arcing.
3. Voltage stabilization.
4. Generation of harmonics.

Test Kit No.	Type	Body Size		R ± 20% at D.C. Calibration Voltage	Max. Watt Loading at 40° C	Price
		Length	Dia.			
V-1	432BNR	1/6"	1/2"	1000 ohms at 10.5V	0.25	\$3.70
V-2	432BNR	1/6"	1/2"	25000 ohms at 10V	0.25	3.70
V-3	432BNR	1/6"	1/2"	100000 ohms at 10V	0.25	3.70
V-4	432BNR	1/6"	1/2"	1 megohm at 10V	0.25	3.70
V-5	479BNR	1/8"	1/2"	100000 ohms at 100V	0.3	3.75
V-6	328BNR	1/6"	3/4"	10000 ohms at 40V	0.5	3.85
V-7	463BNR	1/8"	1"	24000 ohms at 40V	1.	3.95
V-8	524BNR	3/6"	1 1/4"	24000 ohms at 100V	1.5	4.25
V-9	430BNR	1/4"	1 1/2"	17500 ohms at 175V	2.7	4.55

ORDER YOUR KITS NOW! Use this handy coupon



Over 30 years' experience in the field of ceramic special resistance devices.

THE CARBORUNDUM COMPANY, GLOBAR DIVISION, Dept. E-87-72, Niagara Falls, New York

Please ship the following test kits (Min. quantity per order—3 kits)

THERMISTORS:

TEST KIT

Numbers _____

VARISTORS:

TEST KIT

Numbers _____

NAME _____

TITLE _____

COMPANY _____

ADDRESS _____

CITY _____

ZONE STATE _____

Check enclosed

Please invoice us



Looking for germanium

...for transistors?
...for diodes?

Sylvania is your source!

If you manufacture transistors or diodes of any type, you will find that Sylvania can supply the kind of germanium you need.

The following Sylvania germanium products are available: spectrographically pure dioxide; polycrystalline as-reduced ingots; polycrystalline purified ingots; and vertically grown, undoped single crystals. All Sylvania germanium is n-type, and, in the purified ingot or single crystal form, has a minimum resistivity of 40 ohm cm.

Manufacturers of diodes and transistors report important benefits gained through using Sylvania germanium. They report they can use the same doping schedule from ship-

ment to shipment. They report higher yield in the growth of doped single crystals. And for those who grow doped crystals horizontally, Sylvania germanium ingots are purified in five standard boats to fit single crystal boats in popular use.

Whether you prefer germanium in the form of dioxide, as-reduced ingots, purified ingots, or undoped single crystals, Sylvania can fulfill your requirements. Send for a technical bulletin on all forms of Sylvania germanium. Write to:

SYLVANIA ELECTRIC PRODUCTS INC.
Tungsten and Chemical Division
Towanda, Penn.

TUNGSTEN • MOLYBDENUM • CHEMICALS • PHOSPHORS • SEMICONDUCTORS



SYLVANIA

LIGHTING • RADIO • ELECTRONICS • TELEVISION • ATOMIC ENERGY

DYNASERT

Resistor inserting speed tripled...

Product quality improved...



Costs cut at HARMAN-KARDON

Dynasert individually operated machines mechanize insertion of resistors at Harman-Kardon, Incorporated, Westbury, Long Island, New York. Costs were reduced, quality increased and inserting time cut by two-thirds over hand methods.

Improved product quality, increased speed and greater flexibility were the most important reasons why Harman-Kardon decided to use Dynasert individually operated bench machines.

With printed circuit boards ranging from 2" square to 6" x 14" with comparatively short runs, easy changeover is essential. Also, errors resulting from inserting wrong component or wrong location are practically eliminated. They use these machines to feed a variety of components with axial leads. Machines cut, form, insert and clinch leads. Each operator now turns out three times her former output.

In addition fewer components are wasted.

If you would like to cut your component inserting time on printed circuits and improve the quality at the same time, call or write us now.

Industrial Sales Division

United
SHOE MACHINERY CORP.
140 FEDERAL STREET, BOSTON, MASS.
Liberty 2-9100

Production Equipment for Electronics

BOOTH 1419 IRE

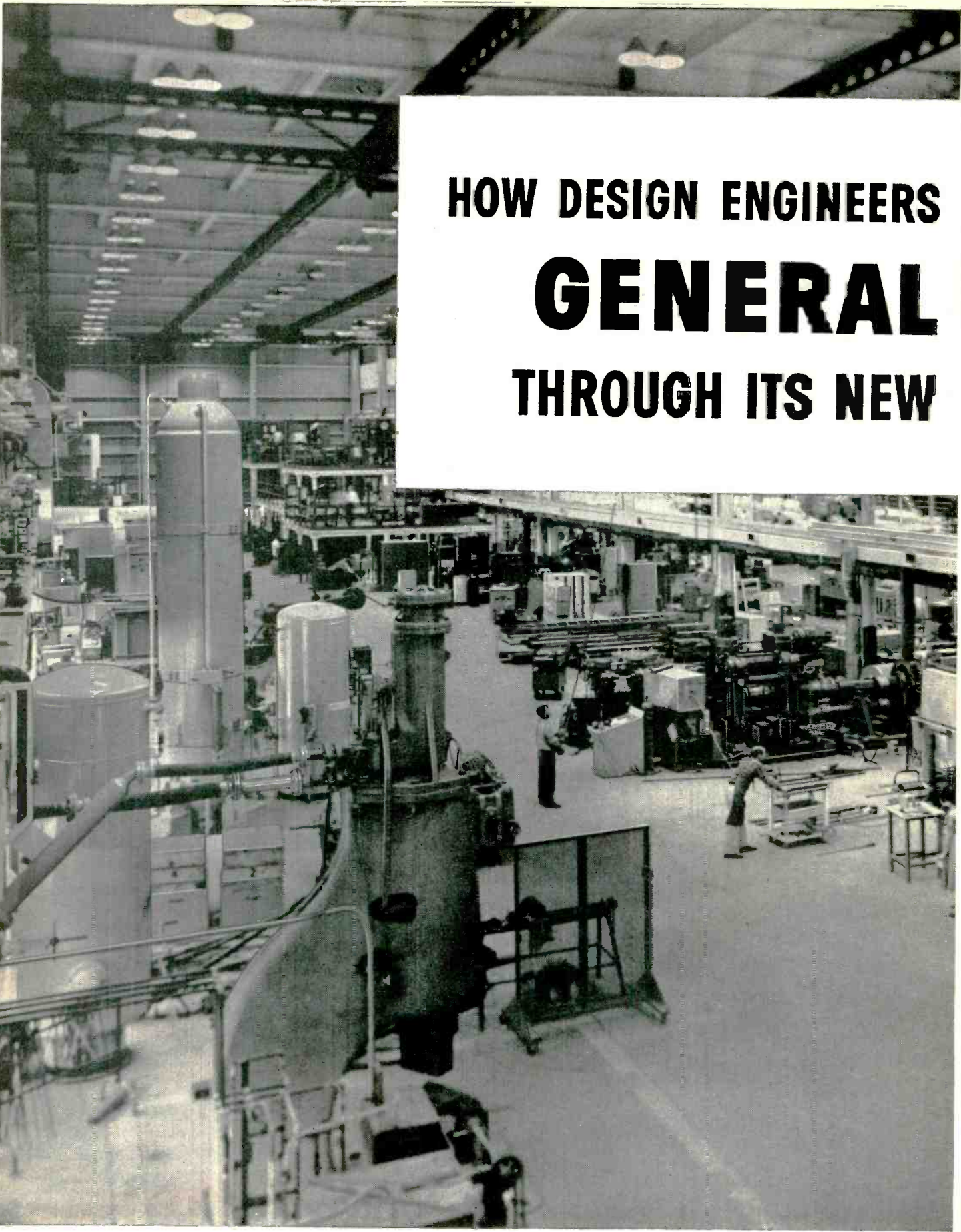

HOW DESIGN ENGINEERS **GENERAL** THROUGH ITS NEW

Laboratory with factory-size equipment — that's the new \$5,000,000 G-E metals and ceramics laboratory in Schenectady. From here will come many of the products manufactured by the Metallurgical Products Department of General Electric Company, 11137 E. 8 Mile Road, Detroit 32, Michigan.



BENEFIT FROM THE RESOURCES OF ELECTRIC METALLURGICAL PRODUCTS DEPARTMENT

**Solutions to your most pressing problems —
plus developments ahead of industry trends —
are now being worked out in our laboratories**

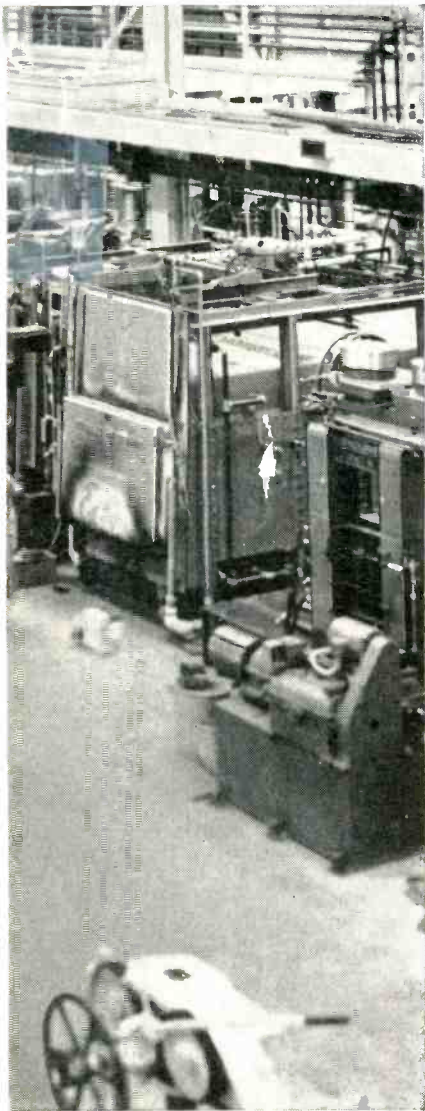

Because designers needed a metal harder and more wear-resistant than steel, General Electric brought out Carboloy[®] cemented carbides. Because designers needed a more powerful magnetic material, General Electric developed improved types of Alnico permanent magnets. Because designers needed better high-temperature metals, General Electric created new vacuum-melted alloys.

These, and many other vital products for design engineers, are the result of General Electric's tremendous resources of technological know-how and skilled manpower in the field of metallurgy. They are created in G-E laboratories . . . and produced for industry by the new Metallurgical Products Department.

This Department is the successor to the Carboloy Department, which was originally organized to manufacture carbides. It now produces such widely divergent metallurgical products as hevimet, thermistors, and Thyrite[®] varistors . . . in addition to chrome and tungsten carbides, and permanent magnets.

The very range of its products indicates how the resources of General Electric are being put to work solving the design engineer's most pressing problems through modern metallurgy.

Perhaps more important, G-E resources like the new Research Laboratory in Schenectady, and the manufacturing facilities of the Metallurgical Products Department, are now combining their talents to produce *ahead* of the trends and needs of industry.

In the Metalworking Industry, for example, this combination of G-E resources has already made one such contribution: Carboloy Cemented Oxide — a new kind of cutting tool material with so great a potential for super high-speed machining, that new machine tools must be designed to take advantage of all it offers.

Developments like these are essential to industrial progress . . . and they are typical of the parade of products design engineers can expect from the G-E Metallurgical Products Department.

Progress Is Our Most Important Product

GENERAL  ELECTRIC

You can't shrink the pilot ...so **Admiral** shrinks the controls

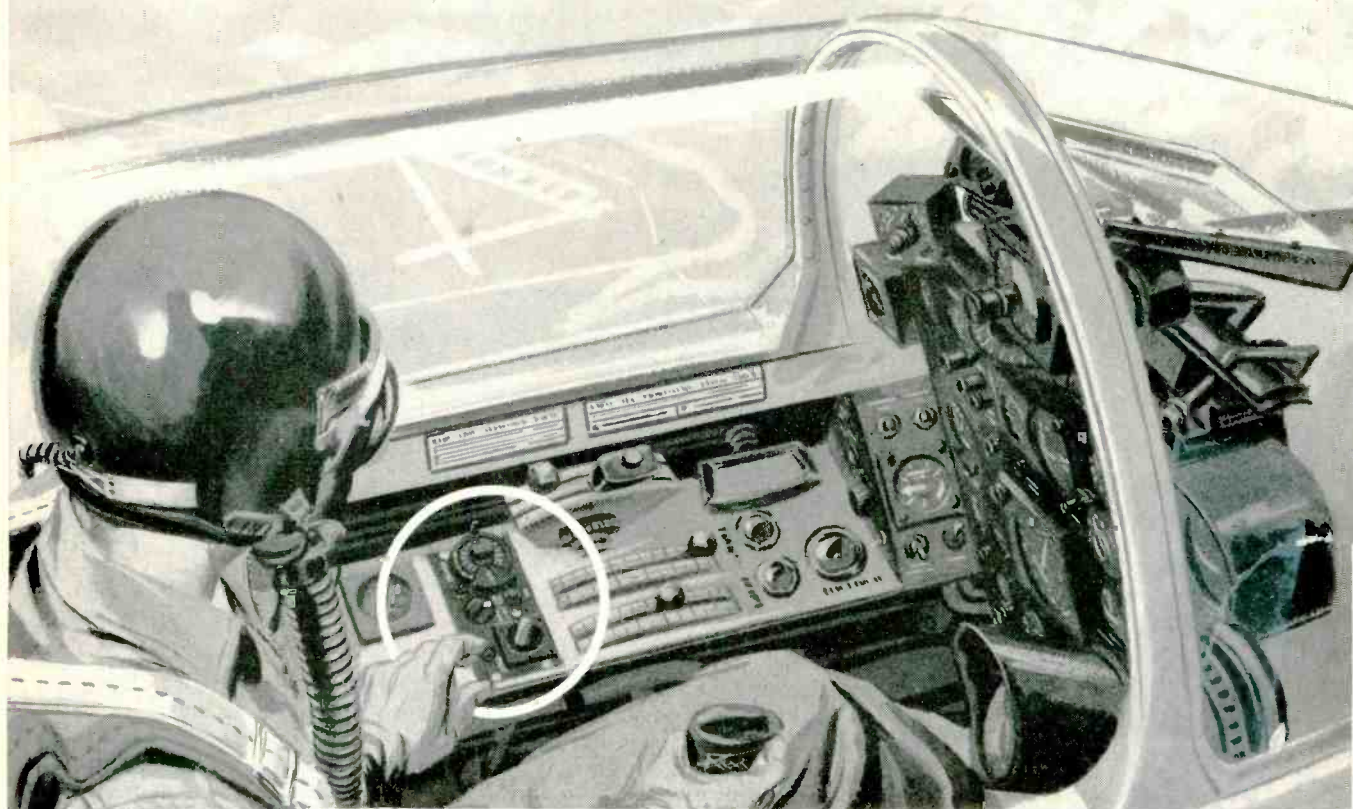

New transceiver control box reduced to one-fifth former size

The cockpit of a modern fighter plane is packed as tight as a filling in a hollow tooth. As more and more electronic equipment is added to the plane's complement, each new device must fight for space on and behind the instrument panel or console. Now Admiral, maker of the famed AN/ARC27 transceiver, has designed a control box that "moves over" to make room for other needed equipment.

Heart of the new control is an ingenious "mechanical memory" drum that selects any one of 20 preset frequencies with a single knob. Another knob controls three coaxial

switches designed by Admiral so the pilot can manually select any of the transceiver's 1750 frequencies. This single compact unit will be universally employed to replace any one of 15 currently used control box combinations. It occupies as little as one-fifth the space and also reduces weight up to 80%.

Here is another instance where Admiral initiated and perfected an important advance in the science of military electronics. Inquiries are invited regarding Admiral's capabilities and production capacity for electronic or electro-mechanical equipment.

Admiral

CORPORATION

Government Laboratories Division, Chicago 47

ENGINEERS: The wide scope of work in progress at Admiral creates challenging opportunities in the field of your choice. Write Director of Engineering and Research, Admiral Corporation, Chicago 47, Illinois.

RESEARCH • DEVELOPMENT • PRODUCTION
IN THE FIELDS OF:
COMMUNICATIONS UHF AND VHF • MILITARY TELEVISION • RADAR
RADAR BEACONS AND IFF • RADIAC • TELEMETERING
DISTANCE MEASURING • MISSILE GUIDANCE
CODERS AND DECODERS • CONSTANT DELAY LINES
TEST EQUIPMENT • ELECTRONIC COUNTERMEASURES

See What's New...

with BECKMAN / BERKELEY TEST INSTRUMENTS • BOOTHS 3416-18

NEW APPLICATIONS

★ FERRISTORS* AND HOW TO USE THEM



Data File #110 gives detailed examples of 14 magnetic circuits, plus complete technical data on FERRISTORS* and how to use them.

★ FREQUENCY MEASUREMENTS AND HOW TO MAKE THEM



Data File #111 covers Berkeley EPUT* meter techniques for low and medium frequencies; Berkeley EPUT* and heterodyne techniques for RF, VHF and UHF; preset counter and time interval meter techniques for rapid low frequency measurements; measurement of rpm, flow, pressure, temperature and strain; setting up a standard of frequency, and nuclear counting techniques.

★ TIME INTERVAL MEASUREMENTS AND HOW TO MAKE THEM



Data File #112 gives detailed descriptions of techniques for measuring elapsed time between pulses, timing relay operation, camera shutter speed measurements, velocity measurements, precise phase angle measurements and low frequency measurements.

NEW PRODUCTS ON DISPLAY



Model 5350 Digital Voltmeter — compact, new 20-lb. portable unit with plenty of exclusive new features. On dc, will measure in the 0 to ± 1 v range, and up to ± 1000 v, at full-scale accuracy of $\pm .2\%$. Input impedance is 11 megohms. Provides 10,100, 1000 v ac scales at $\pm 1.5\%$ accuracy; plus 10 k, 100 k, 1 meg and 10 megohm scales. Has off-scale indicator light, and built-in calibration voltage with 0.1% accuracy. Critical electronic elements contained in temperature-stabilized oven. Variable sampling rate (1 to 20 per sec) permits use with digital recorder.

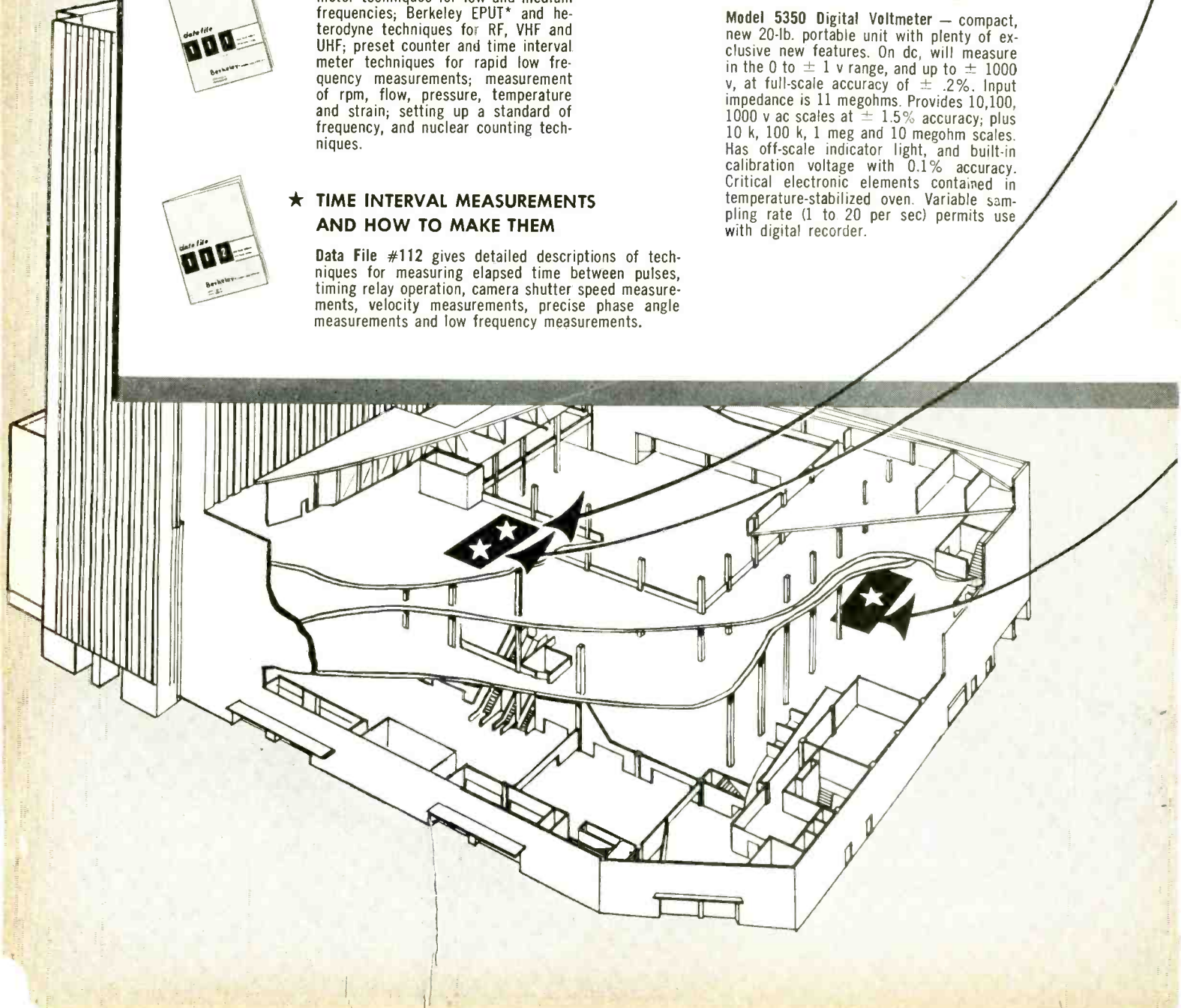

Balances full scale in less than 0.4 second!

Even though loaded with an alarm contact, a transmitting slidewire and a digital encoder, this high speed Speedomax G Recorder will balance in 0.4 second or less. The recording pen sweeps across the $9\frac{7}{8}$ " chart to reach final balance—without overshoot (chart speed is 1" per second).

If you're engaged in rocket or jet engine testing, neutron density measurements in atomic pile startups, in data handling applications, etc., this new Speedomax G Recorder will enable you to measure and record extremely fast changes in the d-c millivolt signal under test.

This fast balancing speed with instrument load-

ing is a result of a newly engineered amplifier that delivers power to a new high-speed balancing motor. The minimum electrical range is 0 to 2 mv with a maximum external circuit resistance of 2000 ohms.

For more information on this fast, powerful Speedomax instrument, write to your nearest L&N Sales Office or to Leeds & Northrup Company, 4979 Stenton Ave., Phila. 44, Pa.



NORTHROP
Automatic Controls • Furnaces

NEW APPLICATIONS

★ **WWV RECEIVERS AND HOW TO USE THEM**

Shasta Data File #10 describes the functions of NBS radio broadcasts from WWV and WWVH, explains in detail how these broadcasts can be utilized for the precise calibration of standard radio frequencies, audio frequencies, time intervals, and musical pitch.



NEW PRODUCTS ON DISPLAY



Model 905 WWV Receiver — covers all six WWV and WWVH frequencies with separate crystals for each; has built-in audio filters for 440, 600, 1000 cps discrimination, and 300 ohm antenna input matcher. Bands and audio discriminators selectable by panel switch — no plug-ins. Rack mounted; modular construction with blower cooling.



Model 100 Transformation Ratio Meter — an rms-reading expanded scale voltmeter with precision voltage divider and input switching for rapid testing of synchros to $\pm 0.2\%$ accuracy. Nominal input voltages are 57.3, 78, 90, 105 and 115; input frequency, 50 to 1,000 cps, impedance 10,000 ohm/v.

NEW PRODUCTS ON DISPLAY

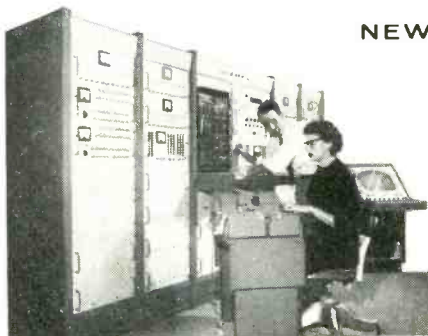

New EASE* 1100 Series Computers with DO/IT (Digital Output — Input Translator system) — a wholly-new concept in analog computation. Provides digital input-output by means of punched tape or electric typewriter, automatic static or dynamic problem checking, complete pushbutton monitoring, fully shielded color-coded patchboard, and many other advanced-design features.

New Analog-Digital Tachometry Systems measure rotational speed, indicate in both analog and digital form. System displayed is similar to those used by Ford Motor Co., and Allison division of General Motors. Analog uses 2-meter indication; first (full scale) has accuracy of 1%; second expanded-scale meter (covers 5% of full scale) has 0.25% accuracy. Digital data is displayed on remote in-line read-out with accuracy of ± 1 count, 1 part in 10,000.

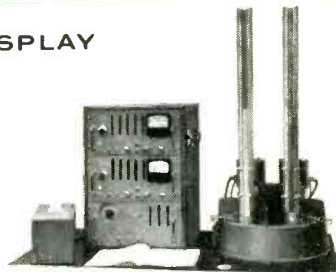

New Automatic Radioassay Equipment — complete systems for automatic sample counting and data recording. Two detector sample changer takes up to 250 samples; data may be recorded by digital printer or fed to card punch for automatic data processing.



Model 5699 Digital Flow Indicator — gives direct-reading digital indication of transducer output frequency or percentage ratio of speed and volume, etc. Features higher sensitivity (ranges from 5 mv @ 5 cps to 1 v @ 100 kc), improved pulse resolution (10 μ sec paired input pulses, 100 μ sec on totalizing), dual range preset time (0.1 sec in 0.1 millisecond increments or 1 to 10 sec in 1 millisecond increments), time base stability of 1 part in 10^6 per day, 5 digit presentation, and versatility to drive digital recorders, remote indicators, data converters, etc.

DON'T MISS THESE TWO BECKMAN/BERKELEY EXHIBITS if you attend the IRE show. If you can't attend, please write us for application data and technical bulletins on the new techniques and new products that interest you. For prompt action, please address Dept. G-3 _____.

Beckman / **Berkeley Division**
 Richmond 3, California
 a division of Beckman Instruments, Inc.

From Electro Instruments comes a revolutionary
new concept in digital instrumentation.

*transistorized,
plug-in modules
for precision
measurements
of dc, ac, ohms
and ratios*

NOW GET MAXIMUM FLEXIBILITY FOR CUSTOM APPLI-
CATIONS WITH STANDARD, OFF-THE-SHELF MODULES

Check these new specifications and features—the result of thou-
sands of applications and field experience of more than 1,000
digital instruments

Fully transistorized circuits in the new modules provide

1. Increased reliability.
2. Reduced power consumption.
3. Low heat dissipation.
4. Miniaturized packages.
5. Elimination of radio noise and line transients.

New specifications and features

1. Wider dynamic range covering all voltages from 100 microvolts to 1,000 volts, resistance range from 10 milliohms to 10 megohms—in single instruments!
2. Input power frequencies from 50 to 400 cycles!
3. New balance logic speeds down ranging!
4. Automatic ac ranging from 30 to 10,000 cycles!
5. Controlled stepping switch drive increases switch life by a factor of three!

Complete flexibility

1. Universal 3½" x 19" x 12" chassis with mounting hardware for any rack.
2. No modifications required for operating printers, IBM Punches, etc., or for combining with auxiliary E-I input modules or instruments.
3. All contacts readily accessible at rear panel on connectors.
4. With auxiliary plug-in modules, digitized data is provided in printed form, punched cards or tape with no modification to basic measuring instruments.

BASIC MODULES

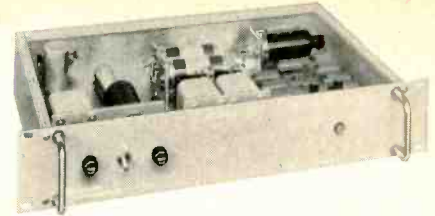

Universal Power Module, Models DXA-000 or DXB-000

Supplies all power and reference voltages for other E-I modules. Power and reference supplies and stepper drive amplifier are transistorized. Powers one or more modules.

Calibration: Automatic

Reference Stability: 0.01% from 40° to 125° F.

Input Power: 115 volts, 50 to 400 cycles.

Write for Bulletin 175-1

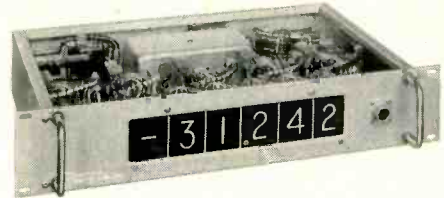

DC Switch Module

Model DVX-400: 4 digits; **Model DVX-500:** 5 digits

Contains Digital Potentiometer. Provides visual in-line read-out of digits, polarity, decimal point. All contacts accessible at rear panel connector. Front and rear panel input connectors. Power supplied by Universal Power Module.

Write for Bulletin 175-2



DC Pre-Amp Module, Model DXX-020

Input: 1 range scale, gain of 10.

Output: 0.0001 to .9999 volts. **Linearity:** 0.01%.

Gain Multiplication Accuracy: 0.01%.

Input Power: 115 volt, 50 to 400 cycles.

Drift: 10 microvolts per hour.

Write for Bulletin 175-5

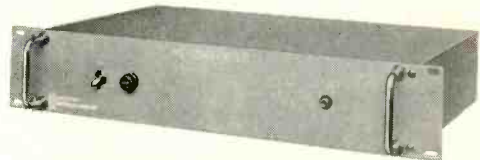

AC-DC Converter Module, Model DXX-010

A fully transistorized AC-DC converter.

Accuracy: 0.1% of reading, or 2 mv.

Frequency Response: 30 to 10,000 cycles.

Range: .0001 to 999.9 volts.

Zin, AC: 1 meg. on the 1 volt scale, 10 megs. on other scales; 20 mmf.

Ranging: Automatic. **Reading time:** 3 seconds, average.

Write for Bulletin 175-4

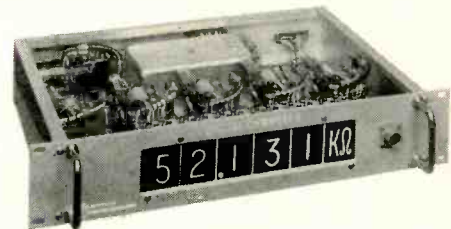

Resistance Switch Module

Model DOX-400: 4 digits; **Model DOX-500:** 5 digits

Contains balance circuit, bridge ratio arms. Provides visual in-line read-out of digits, range. All contacts accessible at rear panel connector. Power supplied by Universal Power Module.

Write for Bulletin 175-3

Using E-I's new, transistorized, modular design, any precision instrument for measuring DC, AC-DC, Ohms, DC and AC ratios can be constructed from basic units!

DC Digital Voltmeters

specifications	Model DVA-400 (Combines Universal Power Supply, Model DXA-000, and Model DVX-400 Modules.)	Model DVA-500 (Combines Universal Power Supply, Model DXA-000, and Model DVX-500 Modules.)
Display:	4 digits, plus or minus, decimal point.	5 digits, plus or minus, decimal point.
Accuracy:	± 1 digit.	$\pm 0.01\%$, plus or minus 1 digit.
Range:	.0001 to 999.9.	0.0001 to 999.99.
Automatic Features:	Ranging, polarity.	Ranging, polarity.

(Adding the E-I Pre-Amp Module, Model DXX-020, increases sensitivity to 10 microvolts.)

DC RATIO METER - Same modules as Voltmeter except uses external reference. Ratio range: 0.0000 to 1.0999.

AC-DC Digital Voltmeters

specifications	Model DVA-410	Model DVA-510
DC Specifications:	Same as Model DVA-400.	Same as Model DVA-500.
AC Specifications:	Same as Model DXX-010.	Same as Model DXX-010.

(AC RATIO METER combines Model DVA-400, with two Model DDX-040 or Model DXX-050 Modules. Ratio range is 0.0000 to 1.0999.)

Digital Ohmmeter

specifications	Model DOA-400 (Combines Model DXA-000 and DOX-400 Modules.)	Model DOA-500 (Combines Model DXA-000 and DOX-500 Modules.)
Display:	4 digits.	5 digits.
Range:	Automatic, 0.01 ohms to 10 megohms.	Automatic, 0.01 ohms to 10 megohms.
Accuracy:	0.01 to 0.1%.	0.01 to 0.1%.



OPERATING MACHINE READ-OUTS

Pictured here is a typical Automation System constructed with standard E-I modules. This system automatically scans and measures 400 channels of AC and DC voltages with punched tape read-out. E-I Model 200 X-Y Recorder provides plotted data. With auxiliary plug-in input and output modules, complete custom data handling systems may be set up. Write for Bulletin 175-6.



NEW HAND-CARRY MODEL

The Mark IV is the ideal companion to the new E-I rack-mounted modular equipment. Compact, weighs only 25 lbs.; 0.05% accuracy. Write for Bulletin 170.



SEE THIS EQUIPMENT AT THE IRE SHOW, BOOTH #3614.

ELECTRO INSTRUMENTS

INC. 3794 Rosecrans, San Diego, California

NEW LITERATURE AVAILABLE—Write for new short form Bulletin 175 containing information about the new Electro Instruments modular design.

Get unprecedented performance—

**See for yourself why the new
LEACH BALANCED-ARMATURE RELAYS
outperform all other types in resistance
to shock, acceleration and vibration**

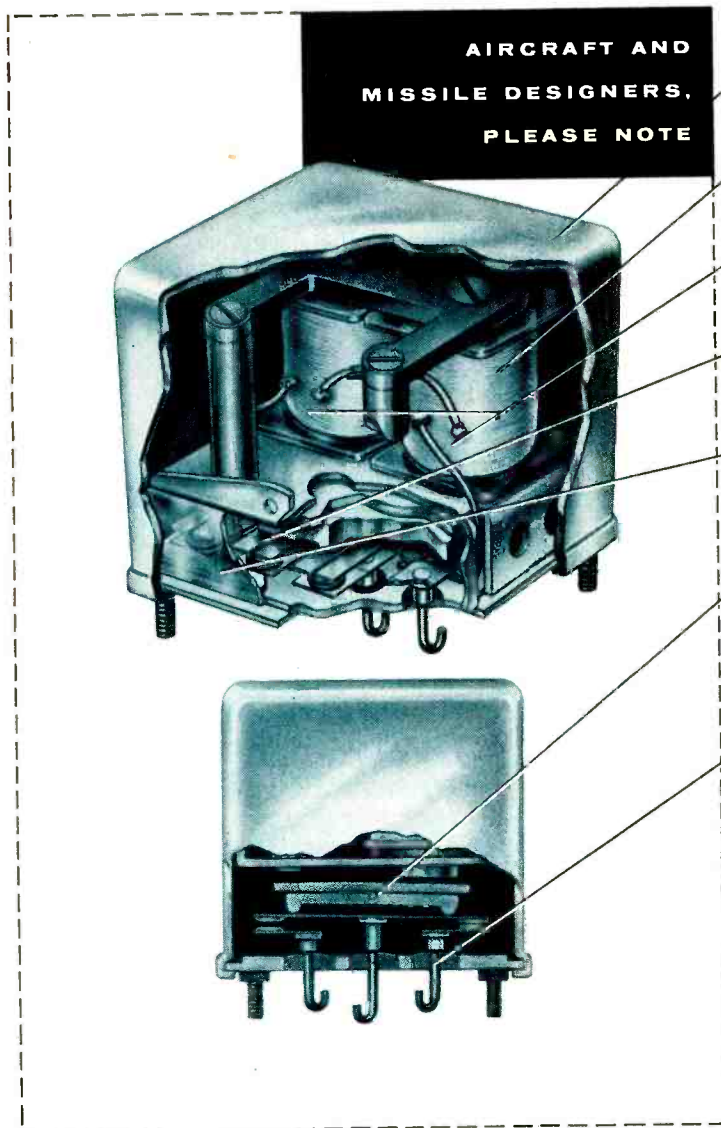

**AIRCRAFT AND
MISSILE DESIGNERS,
PLEASE NOTE**

ONE-PIECE DIE CAST ALUMINUM HOUSING for maximum strength and vibration resistance with minimum weight.

MAGNET COIL wound with Teflon insulated magnet wire on one-piece Kel F bobbin assures reliability at elevated ambients.

DUAL COIL construction is the most efficient magnetic circuit for minimum height and maximum resistance to vibration and shock.

BIFURCATED CONTACTS assure high reliability in contact making circuits. Overtravel and high contact pressures produced by the pivoted armature result in immunity to shock and vibration.

ARC BARRIER of Kel F molded construction provides long arc path for use on 3 phase ac circuits, prevents phase-to-phase flashover.

BALANCED-ARMATURE DESIGN. In a *Balanced-Armature* construction, shock and vibration forces cannot cause the relay armature to move. This eliminates faulty operation of contacts due to vibration and shock forces.

HEADER AND CONTACT ASSEMBLY features simplified construction which eliminates internal wiring, lowers lead resistance, provides maximum resistance to vibration. Contacts and working parts are readily accessible through-out assembly, so that Leach is able to measure contact gap, contact pressure and overtravel, prior to sealing, on 100 per cent of production. Customers are assured of maximum performance from every production relay. Patent Pending.

MEETS ALL REQUIREMENTS OF THE MOST EXACTING OPERATING ENVIRONMENTS

The Leach Balanced-Armature Relays meet or exceed requirements of MIL-R-5757, MIL-R-6106, MIL-E-5272. Typical ratings include: vibration, 20 G's to 500 cps (higher ratings available); shock and acceleration, more than 50 G's; temperature, -50° to $+125^{\circ}\text{C}$; life, 50,000 continuous operations minimum at rated load; coils, any resistance to 10,000 ohms—also available for 115 vac, 400 cps operation.

Write today for your copy of the Leach Balanced-Armature Relay Catalog.

LEACH

CORPORATION

LEACH RELAY DIVISION

5915 AVALON BOULEVARD, LOS ANGELES 3, CALIFORNIA

DISTRICT OFFICES AND REPRESENTATIVES IN PRINCIPAL CITIES OF U. S. AND CANADA





CAPACITORS

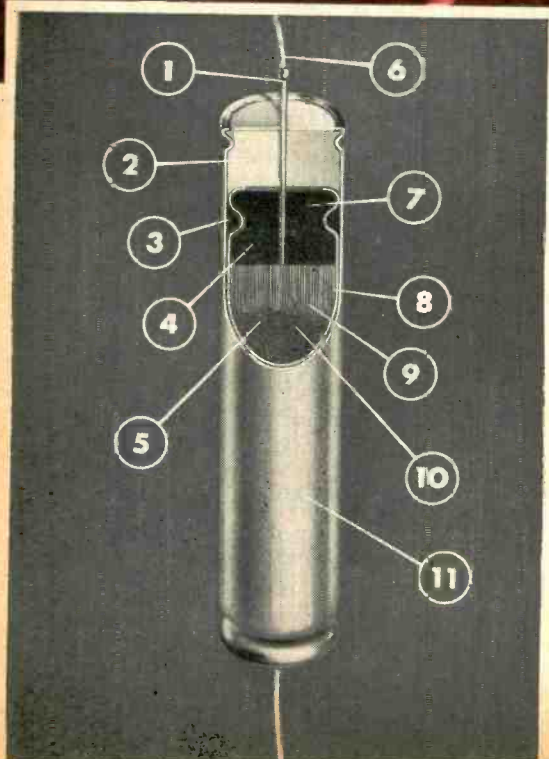

HIGH TEMPERATURE TANTALYTIC CAPACITOR — TUBULAR — features: 1 — Tantalum lead, 2 — Teflon* bushing, 3 — Mylar* insulating sleeving, 4 — Insulation, 5 — Paper and tantalum foil roll, 6 — Solderable nickel lead, 7 — Rubber bushing, 8 — Double metal case construction, 9 — Non-acid electrolyte, 10 — Plain and etched foil, 11 — Polar or non-polar construction.

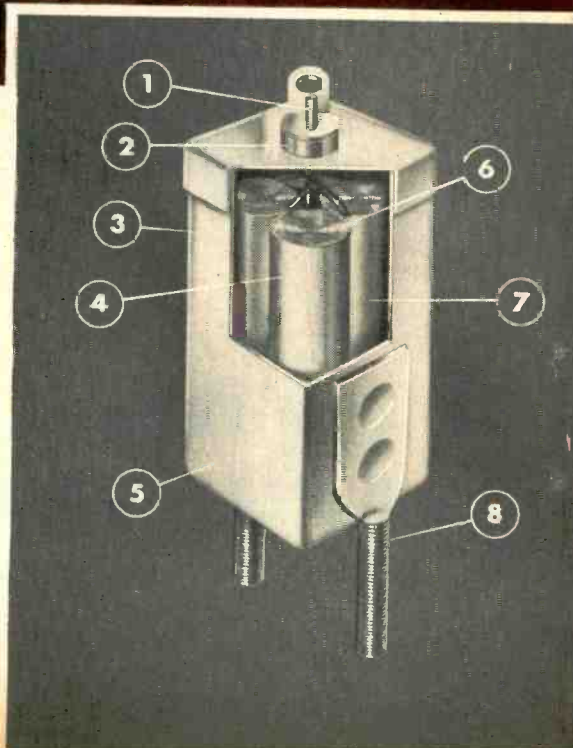

HIGH TEMPERATURE TANTALYTIC CAPACITOR — RECTANGULAR — features: 1 — Tantalum stud, 2 — Silicone bushing, 3 — Polar or non-polar construction, 4 — Paper and tantalum foil rolls, 5 — Silver-plated metal case, 6 — Plain and etched foil, 7 — Non-acid electrolyte, 8 — Mounting stud (optional).

*DuPont Co. Trade Mark

General Electric Tantalytic* capacitors operate at +125 C ambient for 1000 hours at full rated voltage

To help you solve difficult space problems in design functions demanding high reliability miniaturized equipment capable of operating in ambient temperatures ranging from -55C to +125C at full rated voltage, General Electric offers a variety of shapes and sizes of high temperature Tantalytic capacitors.

The Tantalytic capacitor is built for at least 1000 hours operation at +125C with no more than 20% loss in capacity. Below +125C, capacitor life is extended in proportion to the reduction in ambient temperature.

Whatever your capacitor requirements might be, there is a General Electric sub-miniature capacitor for most applications. Take, for example, the metal-clad tubular capacitor — mineral oil impreg-

nated, built to MIL-C-25A — often applied to "work horse" applications in military electronic circuits. Or, capacitor pulse forming networks, adhering to strict capacitance tolerance and temperature range, are engineered for missiles and radar equipment.

New permafил capacitors, built to meet the characteristic "K" requirements of MIL-C-25A, are now available in rectangular case styles. These solid dielectric capacitors can withstand the violent shock and vibration found in today's missile and airborne electronic systems.

For assistance with capacitor applications contact your General Electric Apparatus Sales Engineer or write to the General Electric Company, Section 442-40, Schenectady 5, New York.

*Registered Trade Mark of General Electric Co.

Progress Is Our Most Important Product

GENERAL  ELECTRIC



METAL-CLAD TUBULAR CAPACITORS— +85C, mineral oil impregnated. Built to MIL-C-25A. Ratings: .001 to 1.0 uf, 100-600 v. d-c. Tol: $\pm 5\%$, $\pm 10\%$, or $\pm 20\%$. Write for GEC-1390.

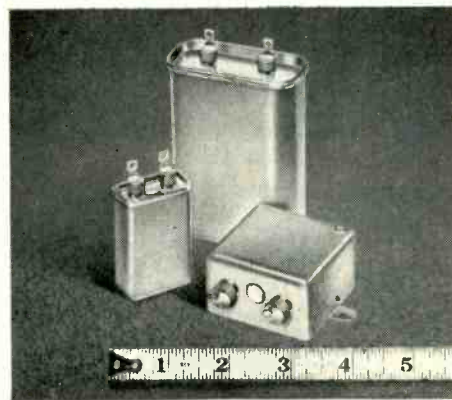

PERMAFIL RECTANGULAR solid dielectric in case styles CP50, CP60, and CP70 series. Built to electrical requirements of characteristic "K", MIL-C-25A. Ratings: .01 uf to 10 uf; 100 v. d-c to 1500 v. d-c, Temp. range: -55C to +125C.

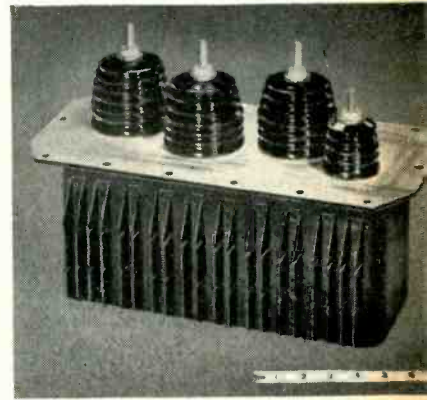

CAPACITOR PULSE FORMING NETWORKS — for missiles and radar equipment. Capacitance tolerance: $\pm 7\%$ (at +25C). Temp. range: -55C to +125C. Write for GEA-4996.

VERSATILITY



TDI MINIATURE TELEMETRIC RECEIVING SYSTEMS

Miniature and mobile, here's a telemetric receiving system designed for a host of military and civilian applications . . . airborne, ground or marine!

For missile checkout, flight tracking experimental aircraft and missiles, the TDI systems are highly effective, even under the most severe field service conditions. They operate ideally with tape recording, oscillographic, photographic and similar types of recording equipment . . . and this rugged equipment can be installed in jeeps, autos and trailers.

Design-wise, these systems achieve substantial reductions in weight, size and power consumption—yet a high degree of accuracy, exceptional stability and simplicity of operation are maintained.

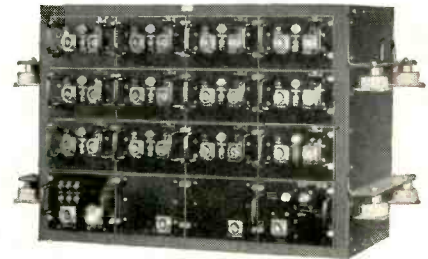

TDI 12-Channel Receiver. Modular construction permits wide flexibility of arrangement and actual form factor of receiving equipment. Packages or combinations in any number from one to eighteen units can be arranged in various mounting styles.



TDI Type 2701A 4-Channel Receiver. Use as flexibly as 12-channel unit—split up in combinations to suit your particular receiving requirements. Ideal for flight line checkout.

← Telemetering on wheels! New portable test cart enables users to perform wide variety of telemetering functions in previously inaccessible locations, with greater efficiency and accuracy than ever before.

Technical bulletins on miniature receiving systems and other TDI products available on request.

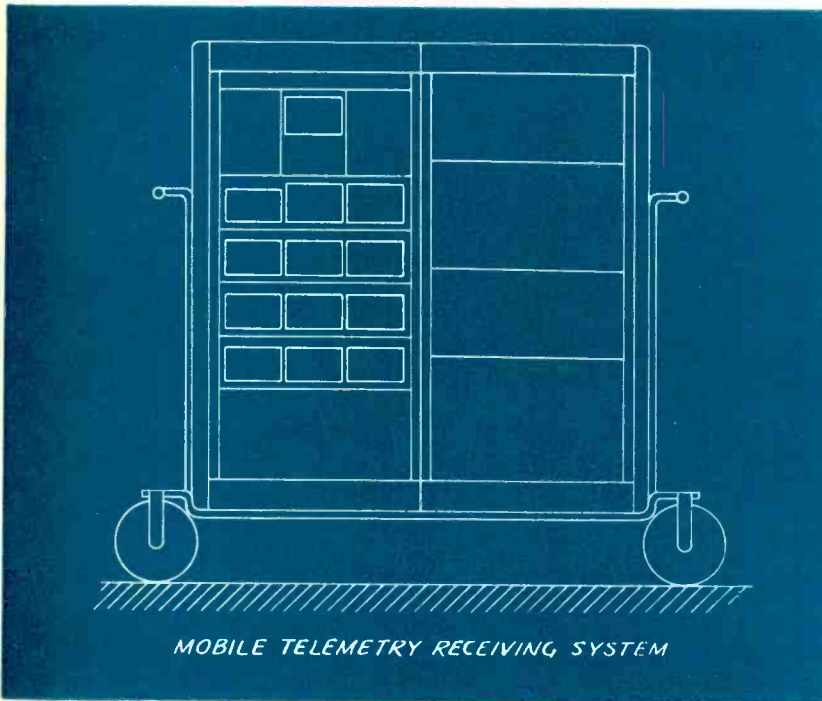

MOBILE TELEMETRY RECEIVING SYSTEM

TDI's newest office is now located at 305 Washington Avenue SE, Albuquerque, New Mexico

- TELEMETERING
- MISSILE GUIDANCE
- GROUND ELECTRONICS SYSTEMS
- AIRBORNE ELECTRONICS SYSTEMS

TELE-DYNAMICS INC.

A Raymond-Rosen Corporation

32ND AND WALNUT STREETS, PHILADELPHIA 4, PENNSYLVANIA

Western Regional Office: 15016 Ventura Blvd., Sherman Oaks, Los Angeles, California

Formerly, Raymond Rosen Engineering Products, Inc.

KENNEDY INTRODUCES

the 28 foot "TUF-SCAT" antenna

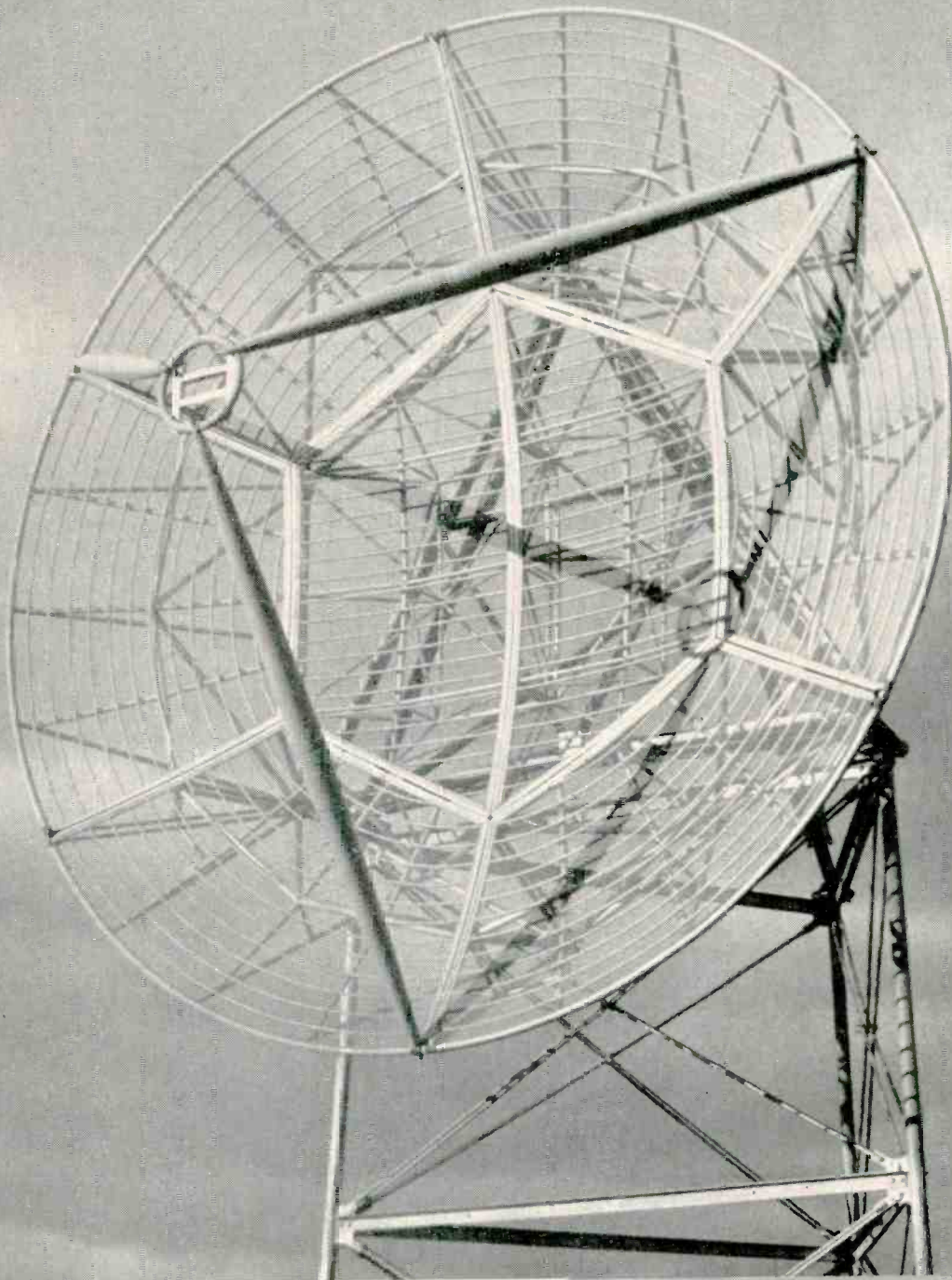

his new scatter antenna is specifically designed for the world's toughest weather conditions. Recently static load tested with over 32 tons (105 lbs./sq. ft.) on its surface, this big dish and tower have been carefully engineered and constructed to withstand winds in excess of 150 M.P.H. Even a 6" layer of ice won't disturb its performance. It is, in fact, the most rugged aluminum antenna ever built. Yet, its light weight, sectionalized aluminum construction keeps shipping costs down, makes assembly easy.

YOU CAN'T MISS US AT THE I.R.E. SHOW-BOOTH #2344



ANTENNA EQUIPMENT

D. S. KENNEDY & CO.

COHASSET, MASS. — TEL: CO4-1200

Tracking Antennas - Radio Telescopes - Radar Antennas -
"Trans-Horizon" Antennas: Ionospheric Scatter - Tropospheric Scatter

Transitron

Silicon

Transitron's diodes, voltage regulators and rectifiers are designed to operate over wide environmental extremes and meet the many varied requirements of electronic circuitry. Reliability is assured through hermetic sealing and exacting manufacturing standards.

Transitron's silicon units have established a record of dependability in such critical applications as guided missiles and jet aircraft. They feature low inverse leakages and high voltage operation and are recommended for high temperature applications where germanium and selenium are unreliable.



- Current ratings up to 2 amps
- Superior regulating qualities
- Rugged construction
- Small size
- Axial mounting

Send for Bulletin TE-1352

VOLTAGE REGULATORS

	Type	Voltage Range	Dynamic Resistance	Maximum Current	
				@ 25°C (ma)	@ 125°C (ma)
Subminiature	SV-6	5.2 - 6.4	20	40	8
	SV-9	7.5 - 10.0	15	25	5
	SV-15	13.5 - 18.0	120	14	3
	SV-24	20.0 - 27.0	300	10	2
Miniature	SV-805	5.2 - 6.4	20	120	24
	SV-808	7.5 - 10.0	15	75	15
	SV-815	13.5 - 18.0	120	40	8
	SV-824	20.0 - 27.0	300	27	5
Power	SV-905	5.2 - 6.4	.7	(amps) 1.6	(ma) 400
	SV-908	7.5 - 10.0	.8	1.0	250
	SV-915	13.5 - 18.0	3.0	.6	150
	SV-924	20.0 - 27.0	8.0	.4	100



"Leadership in semiconductors"



Germanium Diodes

Transistors

Silicon Diodes

Silicon Rectifiers

RECTIFIERS

	Type	Maximum Inverse Voltage	Maximum Forward Current (ma) @ 150°C	Maximum Inverse Current (ma) @ 150°C
Military	*1N256	570	200	.25
	*1N255	380	400	.15
	*1N254	190	400	.1
	*1N253	95	1000	.1
Miniature	TJ40A	400	200	.5
	TJ30A	300	200	.5
	TJ20A	200	200	.5
Stud Mounted	TM64	600	1000	.5
	TM47	400	3000	.5
	1N332	400	400	.2
	1N338	100	1000	.2
Medium Power	TR402	400	(amps) 20	(ma) 5
	1N250A	200	20	5
	1N249B	100	20	5
High Power	TH402	400	35	5
	1N413A	200	35	5
	1N412A	100	35	5

*JAN types specified at 135°C

DIODES

	Type	Maximum Operating Voltage (volts)	Maximum Average Forward Current (ma) (@ 150°C)	Maximum Inverse Current (ua) @ volts (@ 150°C)
Military	*1N457	60	25	5 @ 60
	*1N458	125	25	5 @ 125
	*1N459	175	25	5 @ 175
High Conductance	1N484B	130	50	5 @ 125
	1N486A	225	50	25 @ 225
	1N488A	380	50	25 @ 380
High Frequency	*1N251	30	(@ 125°C) 30	(@ 125°C) 10 @ 10
	1N252	20	40	10 @ 5
	S9G	40	25	10 @ 20
Fast Switching	SG213	200	(@ 100°C) 12	(@ 100°C) 50 @ 175
	SG211	80	12	20 @ 60
	Recovery time .3 usec			
Fast Switching	SG228	200	35	50 @ 175
	SG226	80	35	20 @ 60
	Recovery time 1 usec			

*JAN types



- Reliability at high temperature
- High power handling ability
- High efficiency
- Rugged construction
- Hermetic sealing

Send for Bulletin TE-1351

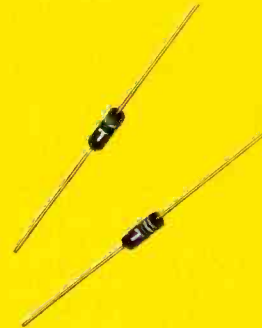

- Recovery times under .15 us
- High voltage ratings
- Operation up to 200°C
- High inverse resistance
- Subminiature size

Send for Bulletin TE-1350

Visit us at IRE Show Booth 3912-14

Transitron electronic corporation
wakefield, massachusetts



**NOW... the world's most
Versatile Coil Winder available as
a complete laboratory unit!**

MODEL **W** COIL WINDER

**THE ONLY COMMERCIAL MACHINE CAPABLE OF
WINDING LATTICE—BOBBIN—INTERLEAVED—SINGLE
LAYER—BANK WOUND—INTERWOVEN COILS.**

Now the world's most versatile coil winder made up in one mobile compact unit complete with all necessary equipment e.g. lubricants, wrenches, instruction book, etc. The model W is capable of winding every type of coil required in the electronic or industrial laboratory except toroids.

SPECIFICATIONS

1/2 HP motor and speed control—Gears from 25-100 teeth—Wire Guide for universal or lattice winding—Wire Guide for bobbins or layer winding—Wire Guide for single or multiple layer coils to 6" in length—3:1 reverse idler for bank winding and long multiple layer coils—Cams for continuous traverse adjustment, 0"-1 1/2"—Large yoke for larger bobbins and transformers—Available with clock counter calibrated in 1/4 turns or with drum type predetermining counter—Universal type arbor for coils with hollow cores—Pi spacing attachment with 1/32 index plate—Adjustable bank winding cam—Feeds for wire as fine as .001"—Rack feed range .00083" to .150" per turn (7-1200 TPI). Maximum distance from head to tail-stock 8"—Layer wound coils using cam traverse 2 to 600 TPL. Net weight 140 lbs.

Model W with cabinet comes with 50 page instruction book complete with charts for universal computation; work sheets and nomographs.

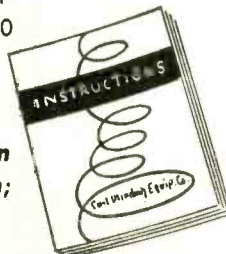

Cabinet made of auto body steel with reinforced corners and ends; heavy duty ball bearing rubber tired caster with 2 foot brakes; size 17x25 1/2x32" high; one cylinder lock secures all compartments.



COIL WINDING EQUIPMENT CO., OYSTER BAY, N.Y. — OYSTER Bay 6-1285

ewec

VISIT US AT BOOTHS 4502-4601—RADIO ENGINEERING SHOW

OAK can engineer
and manufacture
your

**REMOTE-CONTROLLED
SUBASSEMBLIES**

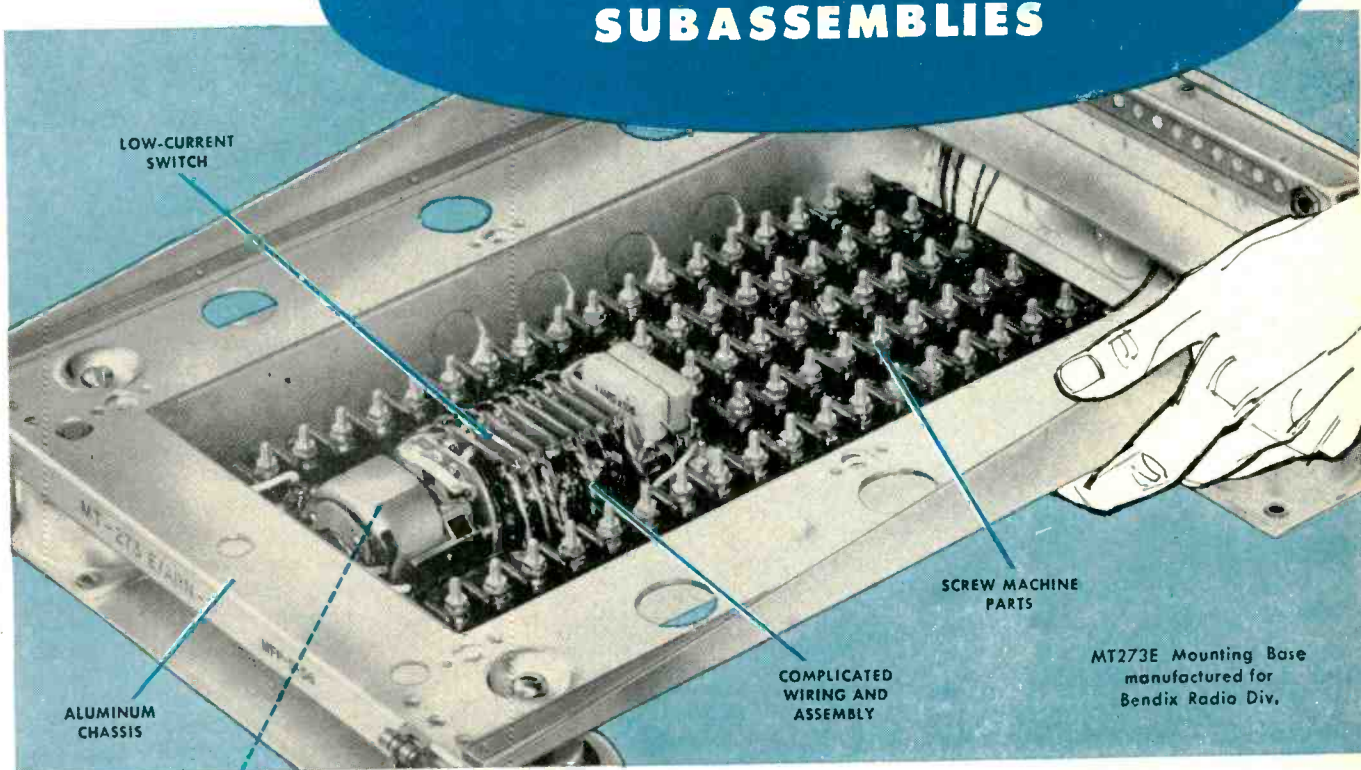

MT273E Mounting Base
manufactured for
Bendix Radio Div.

... one source ... one responsibility
for your electro-mechanical requirements



**OAK ROTARY
SOLENOID***

*Mfd. under license from
G. H. LELAND, INC.

Oak rotary solenoids are ideally suited as actuators for remote control of complex circuits under the severe environmental conditions of MIL-S-4040A, and other specifications which are typical of air-borne, mobile, or military apparatus. They are compact and rugged—being practically solid metal throughout. Oak rotary solenoids are exceptionally adaptable, too. They can be used to drive switches, gear trains, and many other mechanisms requiring a restricted rotary stroke with repetitive operation. Wire-saver circuitry is available to help you economize on wiring.

For the above subassembly, Oak stamps, draws, welds, and etches the aluminum chassis . . . builds the rotary solenoid switch . . . manufactures the screw machine parts . . . makes the complicated cable harness . . . assembles all the parts . . . then runs life tests, heat and cold checks, and humidity chamber trials.

Besides complete facilities, Oak has the knack for making complicated devices producible. Why not contact Oak engineers about your own requirements? Do it early in the design stage. Time and again, they have been able to suggest changes that resulted in lower costs and better operation.

Phone or Write Our Mr. Howard Olson, Today, on Any Aspect of Your Subassembly Projects.

SWITCHES
CHOPPERS
ROTARY SOLENOIDS
SPECIAL ASSEMBLIES
VIBRATORS
TUNERS



1260 Clybourn Ave., Dept. G, Chicago 10, Illinois • Phone: MOhawk 4-2222



FROM DATA TO DIGITS...

Today Hughes is developing systems which convert radar data and other information to digital form and process it for use in performing control functions.

These systems will be able to receive and store vast quantities of data from many different sources and distribute it, after processing, over large and complex ground nets.

Special-purpose digital computers are employed, utilizing magnetic drum memory and novel programming techniques. The systems will also include visual displays and employ the latest concepts of human engineering to simplify equipment operation and minimize the possibility of human error. Vacuum tubes are being replaced by transistors or ferrite cores in flip-flops, registers, and amplifiers; and diode matrices are being replaced by ferro-magnetic circuitry.

These and other features of the new systems promise to maintain and extend Hughes leadership in the fields of digital computers and processing systems. In order to design and build these and future systems, Hughes requires engineers with experience in electronic circuit design, logical design, electronic packaging, radar systems, and many others.

For further information write us at the address below.

HUGHES

RESEARCH AND DEVELOPMENT LABORATORIES
SCIENTIFIC STAFF RELATIONS

Hughes Aircraft Company, Culver City, Calif.

Three unusual direct-display
storage tubes by Hughes

MEMOTRON

FEATURES: bright display . . . constant and uniform intensity of presentation . . . no perceptible transient decay . . . simplifies photography.
APPLICATIONS: transient analysis . . . spectrum analysis . . . direct comparison of wave forms.
SPECIFICATIONS: 100,000 inches/sec. writing speed . . . stores traces until intentionally erased . . . erasure triggered by push-button, or programmed voltage . . . electrostatic focusing and deflection.

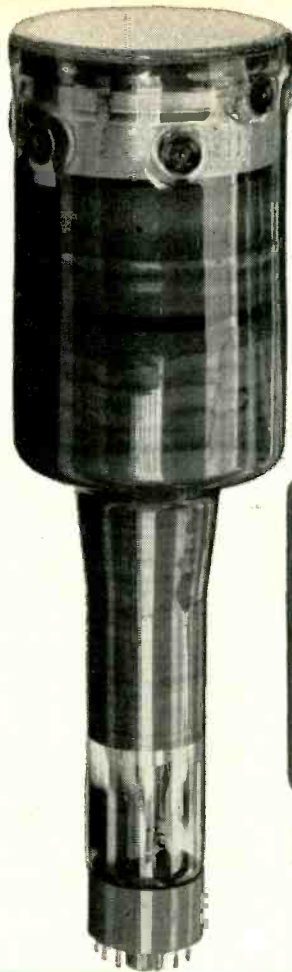

MEMO-SCOPE

Model 104, incorporating MEMOTRON, is a new memory oscilloscope with 5 optional preamplifiers to satisfy the most critical production, test and laboratory requirements.

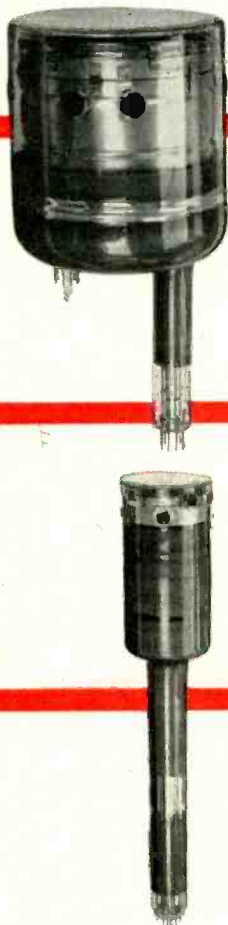

TONOTRON

FEATURES: half-tone presentation . . . excellent grey scale . . . controllable decay rate . . . compact design. APPLICATIONS: closed circuit TV . . . instrumentation . . . P.P.I. . . . narrow band, slow scan TV.
SPECIFICATIONS: 1,000 foot-lamberts brightness at 10 kv . . . electrostatic focusing . . . magnetic deflection . . . 60 lines per inch resolution . . . writing speed of 150,000 inches/sec.

TYPOTRON

FEATURES: high brightness . . . permanent display until intentionally erased . . . rapid display of printed data . . . 63 character matrix. APPLICATIONS: digital computers . . . teletype reception . . . wherever printed data must be displayed rapidly for use by human operator. SPECIFICATIONS: writes up to 25,000 characters/sec. . . permanent storage until erased . . . almost instantaneous erasure . . . electrostatic focusing and deflection.

See demonstrations of these tubes and MEMO-SCOPE at the I.R.E. Show, booths 2801, 2803, 2805, Second Floor. For additional information write to:

HUGHES PRODUCTS • ELECTRON TUBES
International Airport Station, Los Angeles 45, California

HUGHES PRODUCTS

© 1957. HUGHES AIRCRAFT COMPANY



Now!

New low cost oscillator covers entire audio band in one sweep of the dial

-hp- 207A Audio Sweep Oscillator—continuous output 20 cps to 20 KC—flat response, low distortion—may be motor driven or coupled to recording device

SPECIFICATIONS

- Frequency Range:**
20 cps to 20 KC, covered in one range.
- Accuracy:**
±4% including changes due to warm-up, aging components, tubes, etc.
- Dial:**
Six-inch diameter dial calibrated over 300° of arc.
- Frequency Response:**
±1 db entire frequency range.
- External Frequency Control:**
¼-inch shaft, extending from rear of instrument, rotation approximately 150° for full frequency coverage.
- Output:**
10 volts into 600 ohm rated load, balanced or 1 terminal at ground.
- Output Control:**
Decreases level continuously by more than 40 db.
- Distortion:**
Less than 1% over entire frequency range.
- Hum Voltage:**
Less than 0.1% of rated output. Decreases as output is attenuated.
- Power:**
115/230 volts, ±10%, 75 watts.
- Dimensions:**
Cabinet Mount: 7½" wide, 11½" high, 15¼" deep. Rack Mount: 19" wide, 7" high, 12½" deep.
- Weight:**
Approximately 25 lbs.
- Price:**
\$275.00

Data subject to change without notice

Here at last is a low cost, high quality oscillator providing the time-saving convenience of continuous single-sweep frequency coverage from 20 cps to 20 KC. The instrument has high waveform purity, constant output, high stability and dial calibration which is essentially logarithmic. Band switching and resulting transients are eliminated. A flexible 10 volt output can be used balanced or with one side grounded.

Model 207A may be swept by hand, motor driven, tuned remotely or coupled to a recording device by means of a shaft extended through the rear of the cabinet.

Priced at just \$275.00, this new -hp- oscillator is an outstanding value and particularly convenient for such audio tests as speaker frequency response and amplifier flatness, measuring characteristics of filter networks, complex coupled systems and industrial transducers, or automatic response measurements where response is recorded or viewed on an oscilloscope.

**See the new -hp- 207A at the IRE Show,
Booths 2509- 2511-2513.**



550A — highly stable, wide band; 10 cps to 10 MC. For audio, supersonic, video, rf. measurements. Output 15 mw/3 volts. Frequency response flat ± 1 db. \$490.00.



200AB — for audio tests, 20 cps to 40 KC. Output 1 watt/24.5 volts. Simple to use, compact, rugged. \$130.00.



233A — carrier test oscillator covering frequencies 50 cps to 500 KC. Output 3 watts/600 ohms. \$475.00.



200CD — popular precision instrument for audio and ultrasonic tests. 5 cps to 200 KC; output 160 mw/10 volts; 20 volts open circuit. \$160.00.

11

**additional
-hp- quality oscillators**



206A — very low distortion; for high quality, high accuracy audio tests. Covers 20 cps to 20 KC; output +15 dbm. \$565.00.



200J — extreme accuracy for interpolation and frequency measurements. Covers 6 cps to 6 KC, output 160 mw/10 volts; 20 volts open circuit. \$275.00.

● **stable RC circuit pioneered by -hp-**

● **each instrument designed to do a specific job best**

● **outstanding value**
● **complete coverage**
0.008 cps to 10 MC



205AG — time-tested convenience for high power tests, gain measurements. 20 cps to 20 KC 5 watts output. \$440.00.



200T — custom-engineered for telemetry, carrier current tests. 250 cps to 100 KC, output 160 mw/10 volts; 20 volts open circuit. \$350.00.

HEWLETT-PACKARD COMPANY

4170A Page Mill Rd., Palo Alto, Calif., U.S.A.
Cable "HEWPACK" • DAVenport 5-4451
Field engineers in all principal areas



World's most complete line of fast, accurate, easy to use oscillators!



202C — replaces famous 202B for low frequency measurements 1 cps to 100 KC. Output 160 mw/10 volts; 20 volts open circuit. \$300.00.



202A — for servo, vibration, medical and other very low frequency measurements. 0.008 to 1,200 cps. Output 20 mw/10 volts. \$465.00.



201C — specifically designed for high quality audio tests. Covers 20 cps to 20 KC. Output 3 watts/42.5 volts. \$215.00.

TYPICAL ASCOP SWITCHES

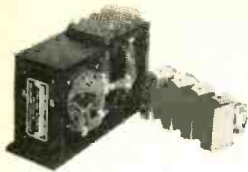

STRAIN GAUGE SAMPLING



TELEMETERING

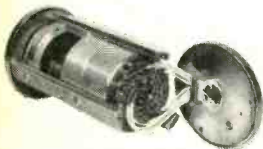

GUIDANCE

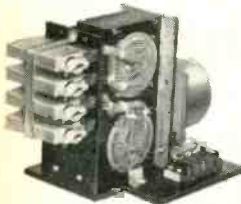

THERMOCOUPLE SAMPLING

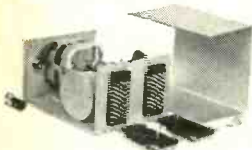

DRIFT COMPENSATION

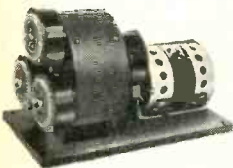

RADAR DISPLAY



CRO DISPLAY

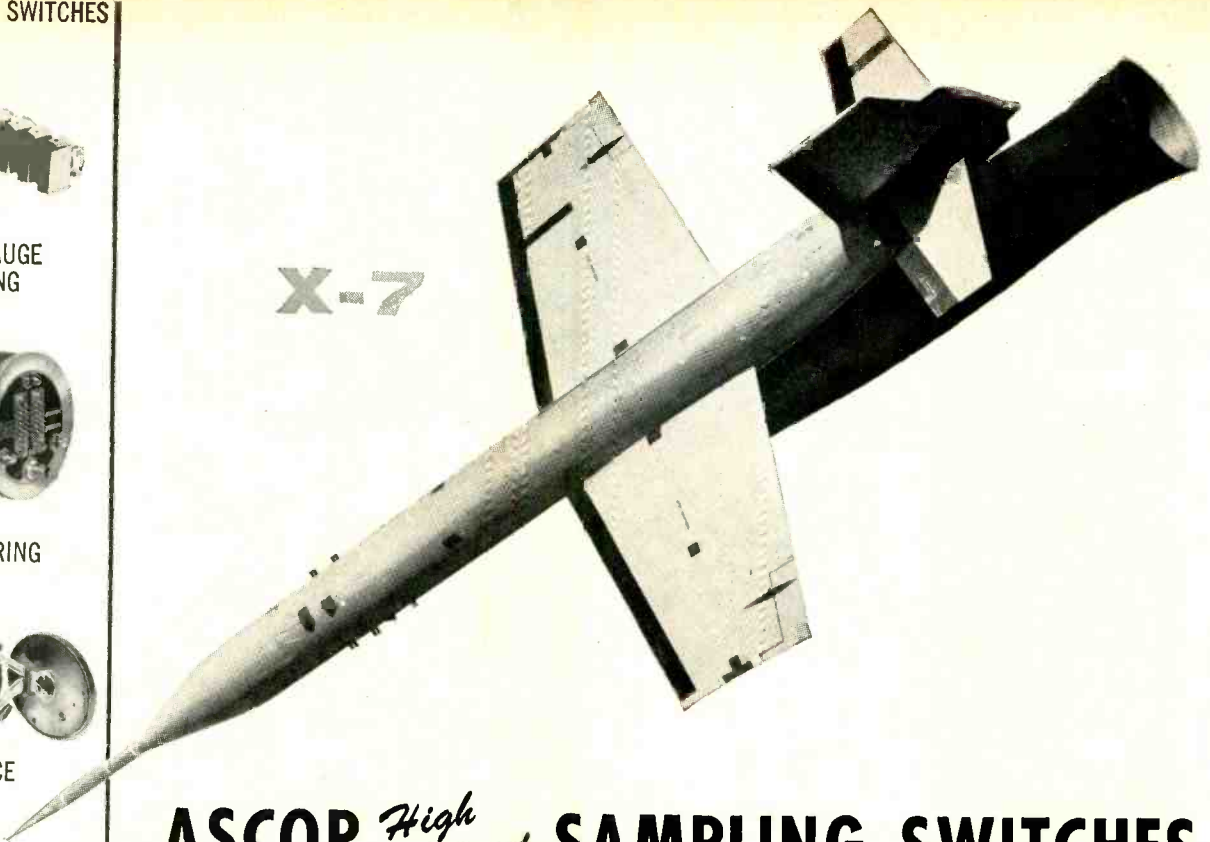

ASCOP *High Speed* SAMPLING SWITCHES

Help Spearhead Ramjet Research in the Lockheed X-7

The needle-nosed X-7 is playing a major role in the development of powerful new engines for Air Research & Development Command ramjet missiles. ASCOP high speed rotary sampling switches are employed in this "flying laboratory" to provide detailed information on *flight attitude, supersonic airspeed, temperature and stress*. As many as 100 measurements of aerodynamic behavior are provided by ASCOP Switches for transmitting to ground stations where the vital statistics are analyzed to contribute to better ramjet performance. ASCOP is the leading manufacturer of rotary sampling switches and has over 200 standard models for use in telemetering, drift compensation, thermocouple sampling, radar display and countless other applications. Write for complete details.

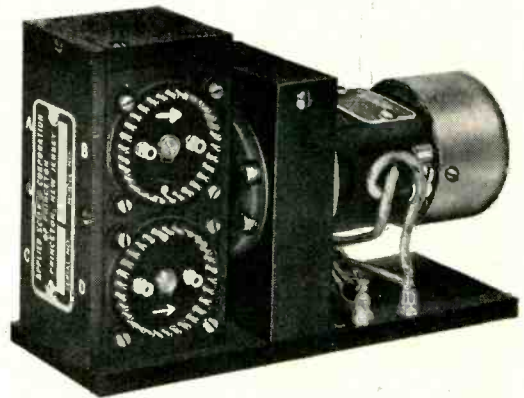

ASCOP SAMPLING SWITCH FEATURES

Easy Installation • Single or Multi Pole • Up to 240 contacts per pole • With or without Motor Drive • Speeds up to 100 RPS • Long Life • Low Noise • Top Reliability • Trouble Free • Precision Construction

APPLIED SCIENCE CORPORATION OF PRINCETON

P. O. Box 44 Princeton, New Jersey • Phone Plainsboro 3-4141

1641 South La Cienega Blvd., Los Angeles, Calif.

Phone Crestview 1-8870



Relay Sales

Telephone Relays

Midget Relays

Keying Relays

Rotary Relays

Sealed Relays

Sensitive Relays

Latching Relays

Stepping Relays

Delay Relays

Timers

Contactors

Motor Starting Relays

Differential Relays

Polarized Relays

AN Approved Relays

Write for Catalog
1957-C8

Relay Sales

why wait for RELAYS

**LEADING MAKES—
LATEST TYPES
IN STOCK!**

AUTOMATIC ELECTRIC
Type BQA and Many
Others in Stock

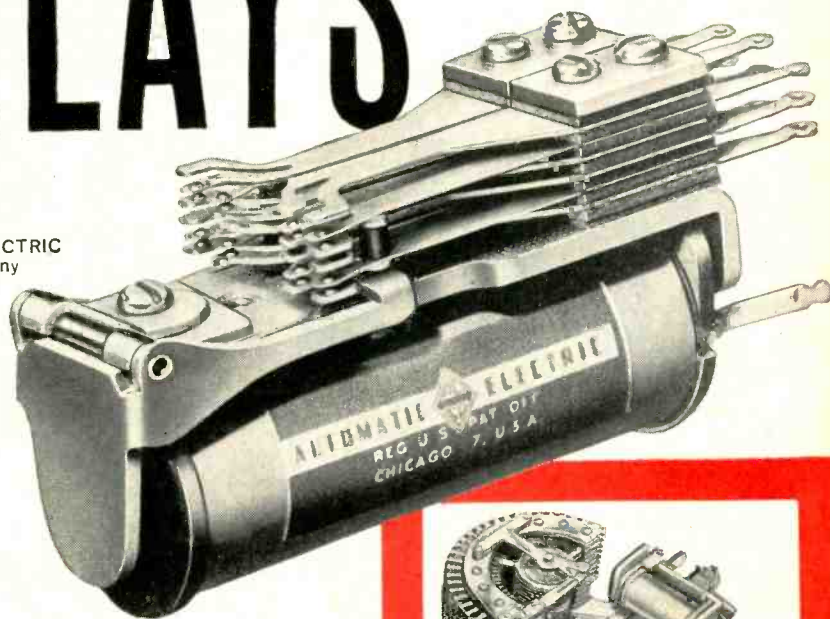

We maintain complete distributor stocks of the following makes:

Advance Relays	Phillips Controls
Automatic Electric	Struthers-Dunn
Clare	Leach Relays
Neomite-Elgin	Terado and Others

We Anticipate Your Relay Needs

Relay Sales cannot get better delivery from manufacturers than you. Relays now in stock were ordered as long as 10 months ago and selected by men who have specialized in supplying relays to the industry for many years. The items illustrated are typical of hundreds of thousands in stock. They are available in all popular coil ratings and contact arrangements. Why wait for relays? Call us today!

Write or Phone for Same Day Shipment
Phone: West Chicago 1100

RELAY SALES, INC.

P.O. Box 186-A

West Chicago, Ill.

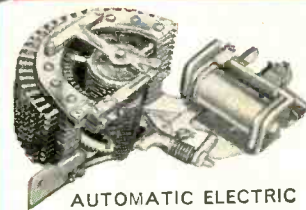

AUTOMATIC ELECTRIC
Type 45 Stepper
Wide Selection

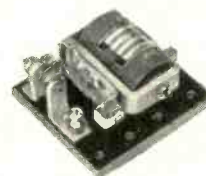

STRUTHERS DUNN
Keying Relay
Many Types in Stock

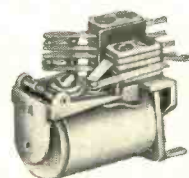

PHILLIPS CONTROL
9QA Midget for Sub Chassis
Mounting. Many Others
in Stock



(Actual Size)
NEOMITE-ELGIN
Sub Miniature Hermetically Sealed
Relay. All Advance Types in Stock

No blue sky... just to back up our belief that you and Collins

We're going to build a proposition which we believe deserves your most serious consideration, if you are a mechanical or electrical engineer. This proposition is built on pure and simple fact—no high flown promises or broad generalities. Our proposition: you and Collins should get together. We present these facts to support it.

FACT NUMBER 1:

Collins Radio Company's sales have increased 10 fold in each of three successive seven year periods. 1933 sales were \$100,000; 1940 sales, \$1,000,000; 1947 sales, \$10,000,000; 1954 sales, \$100,000,000, and 1956 sales, \$126,000,000. (Note graph.) This company has grown, and is growing at a phenomenal rate. Total employment is 9,000 of which 24% are research and development personnel.

You grow when the company you work for grows.

FACT NUMBER 2:

As shown in the graph at right, the employment of research and development personnel has increased steadily despite fluctuation in sales. Notice that even during periods of national sales regression Collins continued to strengthen its engineering staff.

Collins has based its growth on the solid foundation of stability in the engineering department.

FACT NUMBER 3:

At Collins, the ratio of engineers to total employees is extremely high, far higher than the average among established companies engaged in both development and production. First and foremost, Collins is an engineering company.

Engineering is king at Collins—never takes a back seat to production expediency.

FACT NUMBER 4:

Collins' reputation for quality of product is universally recognized. It has led to Collins' phenomenal sales record. At Collins there is no compromise when quality is at stake. *If you're the man we want, you'll get real satisfaction out of this quality-consciousness.*

FACT NUMBER 5:

Electronics is Collins' only interest. In no way is it subsidiary to the manufacture of industrial or consumer products. Collins builds electronic equipment, not airplanes or vacuum cleaners. Every research, development and production facility is devoted to progress in electronics.

If electronics is your interest, you'll like the climate at Collins.

FACT NUMBER 6:

There is a limitless variety of fields and types of work for the Collins engineer. Recent Collins work in air and ground communication, and aviation electronics include developments in transhorizon "scatter" propagation; single side-band; microwave and multiplex systems; aircraft proximity warning indicator; aviation navigation, communication and flight control; broadcast; and amateur equipment.

There is big opportunity for your special talents.

Right now we are prepared to offer you a technical or supervisory assignment in one of many interesting fields. And the sky is the limit as far as responsibility and salary are concerned.

You will work in one of Collins' new research and development laboratories located at Cedar Rapids, Iowa; Dallas, Texas; and Burbank, California. Offices and subsidiary companies are located in New York; Washington, D. C.; Miami; Knoxville; Seattle; Hickman Mills, Missouri; Toronto, Canada; London, England; and South America. All your moving expenses are paid. Company benefits are tops in the industry.

We repeat—if you are a mechanical or electrical engineer, you and Collins should get together. Take the first step now, send your resume today to:

L. R. NUSS Collins Radio Co. Cedar Rapids, Iowa	FRED AIKEN Collins Radio Co. 2700 W. Olive Ave. Burbank, California	HAROLD MCDANIEL Collins Radio Co. 1930 Hi-Line Drive Dallas, Texas
--	--	---



black and white facts

should get together

Collins will be interviewing engineers and tech writers at the IRE Show in New York March 18-22. Call L. R. Nuss, Circle 5-7076, for a personal, confidential interview.

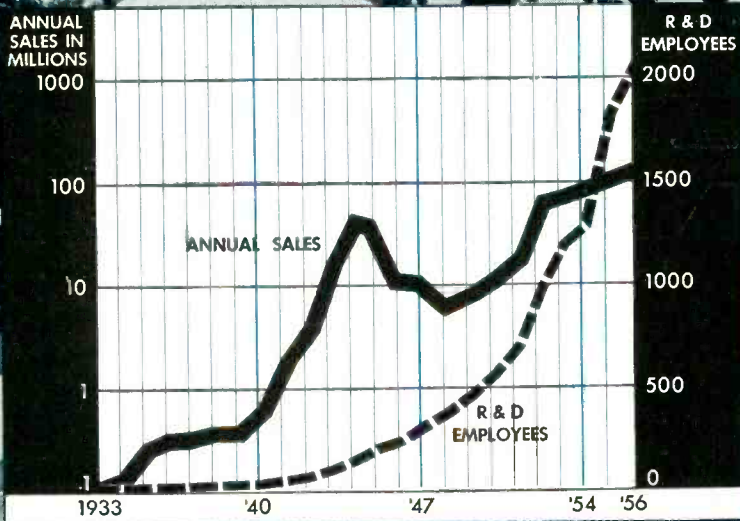

This graph shows the relationship between sales and employment of engineering personnel at Collins. Notice the steady increase in research and development employment despite sales fluctuations.

Collins new research laboratory building at Cedar Rapids, Iowa. Air-conditioned, shielded against radio waves, completely equipped.

Collins

CREATIVE LEADER IN ELECTRONICS

COLLINS RADIO COMPANY • CEDAR RAPIDS • BURBANK • DALLAS



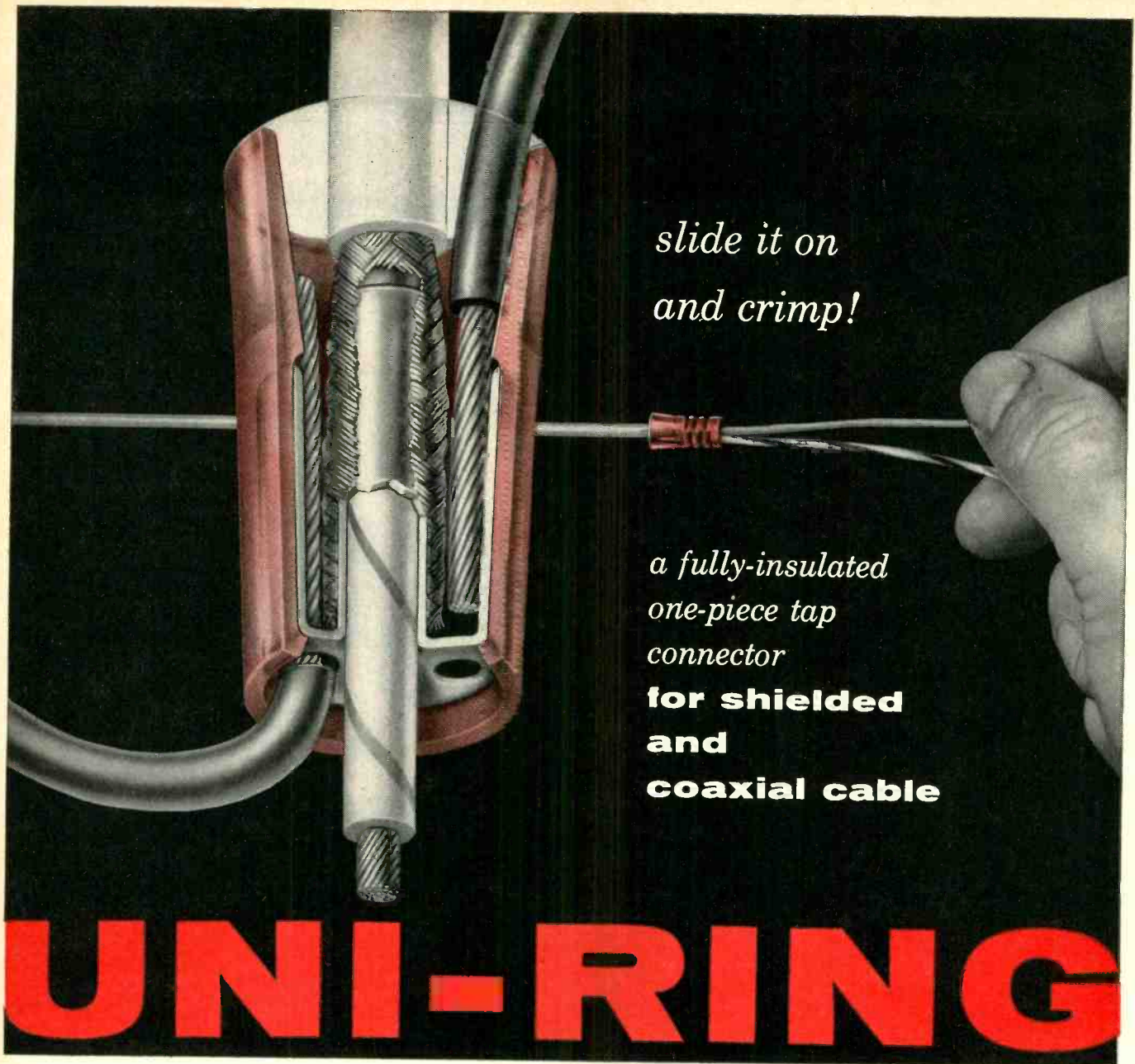

*slide it on
and crimp!*

*a fully-insulated
one-piece tap
connector
for shielded
and
coaxial cable*

UNI-RING

UNI-RING offers a tremendous saving in installation time over any previous method of tapping or terminating shielded or coaxial cable. As the inner ring slides under the shielded braid, the tap wire is held between the braid and the outer ring. Single or multiple taps, from either the front or back of the connector, can be accommodated . . . A single crimp, using the same basic HYTOOLS used for installing HYRINGS, completes the uniform, secure, and insulated assembly.

The protecting nylon insulation extends beyond both ends of the UNI-RING, eliminating metal-to-metal contact and preventing harmful wire-chafing in tight locations. The UNI-RING is color-coded to indicate conductor sizes.

UNI-RING's one-piece design insures electrical integrity, prevents heating, and eliminates noises caused by isolated metal parts.

For samples and complete details, write: OMATON DIVISION

BURNDY

Norwalk, Connect. • Toronto, Canada • Other Factorles: New York, Calif., Toronto • Export: Phillips Export Co.

56-15

NEW RAYTHEON PRODUCTS

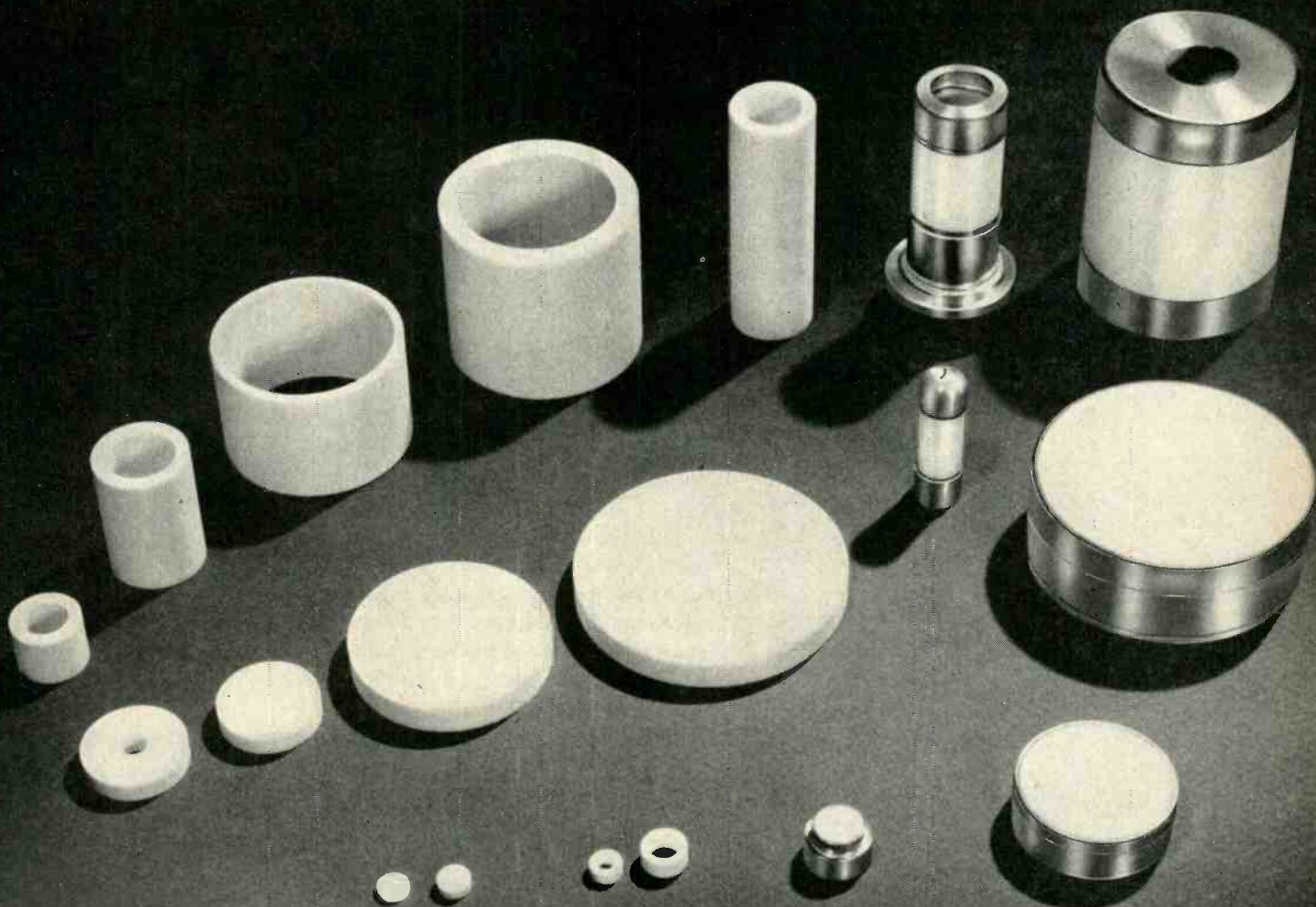

For those who need the most demanding ceramic characteristics ... RAYTHEON R-95 HIGH-ALUMINA

We make only one kind of ceramic—high-alumina. As a manufacturer of tubes, Raytheon demands ceramic quality of utmost *purity* and *controlled consistency*. Our own R-95 ceramic meets these exacting demands.

You will find R-95 high-alumina ceramic completely dependable where high strength, high temperature, reliable vacuum seal, improved electrical performance, and high corrosion or abrasive resistance applications are involved. Raytheon will supply ceramic parts manufactured from R-95 high-alumina either alone or as hermetic ceramic-to-metal assemblies in accordance with your specifications. The assemblies can subsequently be soft or hard soldered into your production in your own plant.

Write for complete specification sheet. Supply us with a sketch or drawing outlining dimensions and tolerances, together with operational conditions. We will be happy to provide information and assistance on any of your ceramic requirements—without cost or obligation.

Bright Futures for Ceramic Engineers

Join an outstanding group of engineers in expanded ceramic development, working in the most modern ceramic plant in operation. Fascinating projects, excellent salaries, fine living conditions. Write address below.

RAYTHEON MANUFACTURING COMPANY

Ceramic Sales

Waltham 54, Massachusetts



*Excellence
in Electronics*

See you at the IRE, Booths 2611-2614, New York Coliseum, March 18-21



4K50,000LQ

This four-cavity externally-tuned klystron is typical of an extensive line of Eimac high and super power klystrons for UHF/microwave application. Water and forced air cooled, the Eimac 4K50,000-LQ will deliver 10,000 watts of power at frequencies up to 1000 megacycles.



EIMAC FIRST with ceramic tubes that can



Ceramic Receiving Tubes

Eimac, the world's largest manufacturer of transmitting tubes, enters the receiving tube field with a significant new concept—the stacked ceramic receiving tube. Design eliminates internal insulators and spacers. These new stacked ceramic tubes can withstand heavy shock and vibration with low noise output.



2CL40A

A new, small ceramic high vacuum rectifier or clipper diode that can be air or liquid cooled. Under the latter conditions, average plate current is 120 milliamperes, with a peak inverse voltage of 16,000 volts.

3CX100A5

Here is a new premium quality ceramic and metal 100-watt triode similar to the 2C39B. It is used as a CW amplifier or oscillator to 2500 megacycles, and in pulse applications to 3000 megacycles.



take it...



4CX300A

A remarkable general purpose power tetrode designed especially for compact, medium power equipment. Smaller than a tennis ball, it has a plate dissipation of 300 watts with forced air cooling and will operate to 500 megacycles at maximum ratings.

In recent years equipment manufacturers and users have been introduced by Eimac to a series of ceramic tube firsts unequalled in the industry: klystrons, negative grid tubes, rectifiers and receiving tubes.

Clean, and rugged... these tubes can stand up to shocks and temperatures no glass tube can. Design and production advantages are a boon to equipment manufacturers and users alike.

As first in the field, Eimac has developed ceramic tube manufacturing techniques that have evolved into well established processes.

See this line of "tubes that can take it" at the Eimac exhibit, Booth 2410-12, National I. R. E. Show and Convention, March 18-21.



EITEL-McCULLOUGH, INC.
SAN BRUNO · CALIFORNIA
The World's Largest Manufacturer of Transmitting Tubes



4CX5000A

This Eimac radial-beam power tetrode is especially suitable for single sideband operation. A rugged ceramic tetrode, it delivers 10 KW output in Class AB1 service and handles high inputs without going into the positive grid region.

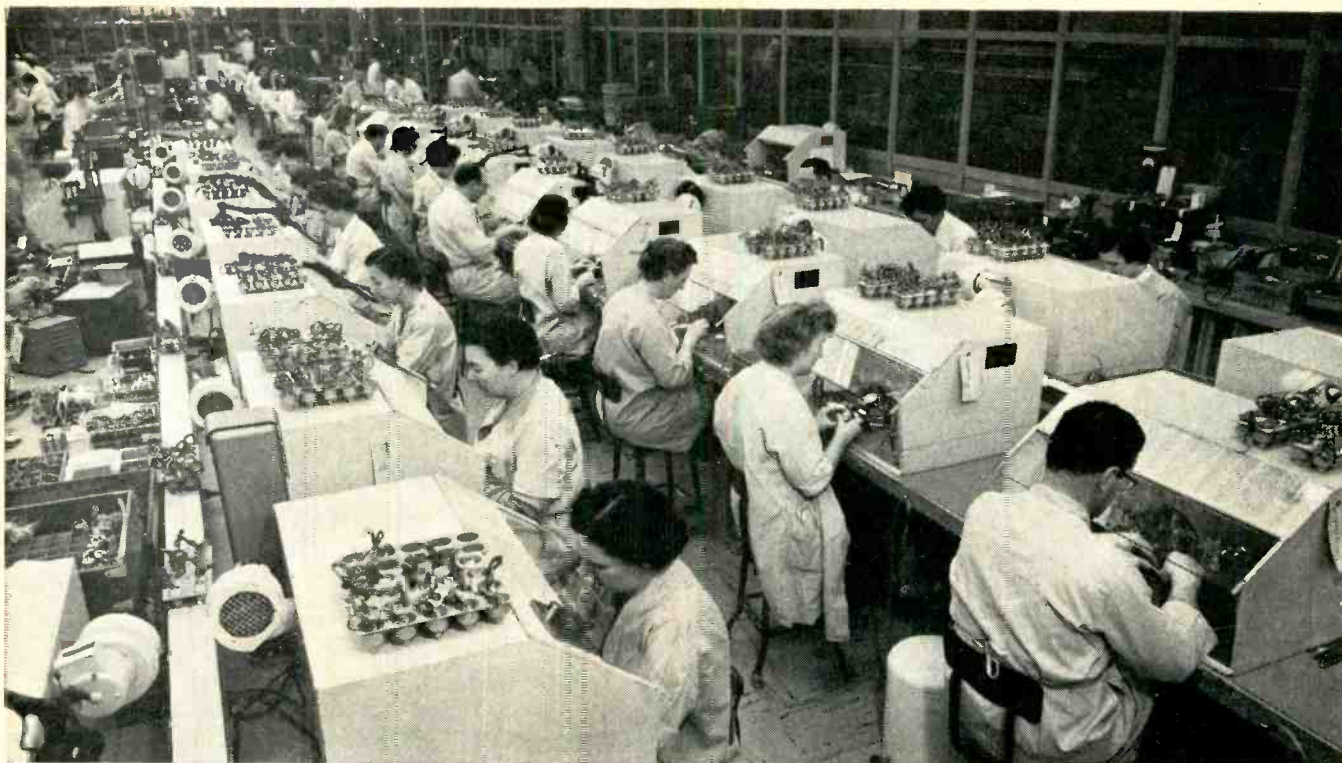

Portion of Eclipse-Pioneer's synchro calibration and test facility.

WHY IT PAYS TO SHOP AT THE BENDIX "SUPERMARKET"

— NATION'S LARGEST PRODUCER OF SYNCHROS

SHAFT POSITION-TO-DIGITAL CONVERTERS



Eclipse-Pioneer Coded Commutator type shaft position-to-digital converters are miniature devices for converting Analog information to Binary Digital form. Designed for Digital control systems, data processing equipment, telemetering applications, or computers. Especially suited to air-borne use.

Specifications:

	Model GS-1-A1	Model GS-2-A1
Type output	8 digit gray (Reflected Binary Code)	7 digit Natural Binary Code (double brush)
Shaft resolution	1 part in 256	1 part in 128
Current rating	.015 amps. (max.) per digit with non-inductive loading	.015 amps. (max.) per digit with non-inductive loading
Shaft speed	Max. continuous input of 150 revs. per minute	Max. continuous input of 150 revs. per minute
Input torque	0.2 ounce-inch (max.)	0.4 ounce-inch (max.)
Diameter of unit	15/16 inch	15/16 inch

In buying precision synchros, doesn't it make a lot of sense to insist on getting exactly what you want, when you want it—and at minimum cost?

Best way to be *sure* you get all three is to depend on the Bendix "Supermarket".



Our mass synchro production facilities . . . the nation's largest . . . are constantly turning out just about all types of synchros imaginable. This means we can offer you immediate delivery of most synchro types—and minimum cost on all synchro types, even for small quantity orders.

You can depend on the quality of Bendix synchros, too. They will equal . . . or exceed . . . the accuracy of any other synchros made today. Sound reasons why you'll be ahead to rely on the experience and mass-production facilities of *Bendix*.

District Offices: Burbank, Calif., Dayton, Ohio, Seattle, Wash.
Export Sales and Service: Bendix International Division, 205 E. 42nd St., New York 17, N. Y.

Eclipse-Pioneer Division

Teterboro, N. J.



SEE OUR FULL LINE OF
PRECISION COMPONENTS
ON DISPLAY AT THE NEW
YORK I.R.E. SHOW, MARCH
18-21, BOOTHS 2322-2332.



AMP'S PATCHCORD PROGRAMMING SYSTEM

Speeds confirmation of airline reservations

A wide variety of AMP Taper Technique product provides long-life assurance of perfect electrical terminations and is a contributing factor in keeping electronic equipment compact. The AMP Patchcord Programming System offers a multifirmity of internal wiring arrangements and connections and permits circuit versatility by use of prepatched, removable front boards.

A number of major airlines, including the Long Island City facilities of Pan American Airlines (shown above), have installed electronic equipment manufactured by Teleregister Corporation, Stamford, Connecticut to eliminate delay and uncertainty in air travel reservations procedure. AMP Taper Technique and AMP Patchcord Programming Systems are prominent in the design of this equipment.

AMP Taper Technique and AMP Patchcord Programming Systems have been utilized for years to solve problems inherent in the design of computers, business machines, and automatic control equipment.

Complete information is available on request.

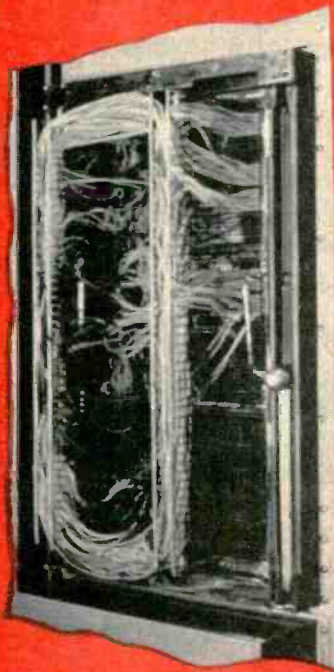

You are cordially invited to visit our display at the IRE show in New York City, March 18th to 21st, 1957.

BOOTHS 2427-2429

AMP INCORPORATED



General Office: Harrisburg, Pa.

Wholly Owned Subsidiaries: Aircraft-Marine Products of Canada Ltd., Toronto, Canada
Aircraft-Marine Products (G.B.) Ltd., London, England
Societe AMP de France, Le Pre St. Gervais, Seine, France
AMP—Holland N.V. 's-Hertogenbosch, Holland
Japanese Distributors: Oriental Terminal Products Co., Ltd., Tokyo, Japan



MICRO SWITCH Precision

... FIRST IN PRECISION SWITCHING

HOW MICRO SWITCH

ENGINEERING SERVICE

can keep a small switch from becoming

a BIG PROBLEM

in your design

MICRO SWITCH Engineering Service is a two-way street. Field engineers and factory engineers work together to make sure you get the right MICRO SWITCH precision switch for your application.

This teamwork between experienced switching specialists assures that the precision switches you incorporate in your equipment are

the right switches for your application and will give reliable, dependable, day-in, day-out service.

You can take advantage of this teamwork by calling MICRO SWITCH today. Switching specialists—with close contact at the world's largest headquarters for precision switches—are available at branch offices in key cities.

**CONTROLS
MANY
CIRCUITS
WITH ONE
MANUAL
MOTION**

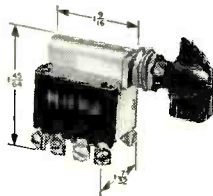

This three-position, rotary-type toggle switch offers all the advantages of a toggle switch mechanism with longer operating life and better detent "feel." Shown is a four-pole double-throw switch with 12 terminals. It is maintained in all three actuation positions, on-off-on. This switch can handle a high electrical load and has passed severe tests for impact, shock, acceleration and vibration.

(Send for Data Sheet 112)

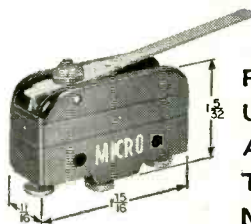

**PRECISE,
UNERRING
ACTUATION
THROUGH
MILLIONS
OF OPERATIONS**

Adjustable lever actuator permits close adjustment of switch operating point without removal from mounting. It provides unusually reliable service on such equipment as timers, computers or other multiple-mounted devices which require precise, unerring operation through millions of operations. Available with normally open, normally closed double-throw or split-contact circuitry.

(Send for Data Sheet 100)

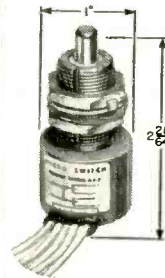

**FOR PRECISE
PERFORMANCE
UNDER MOST
EXTREME
CONDITIONS**

MICRO SWITCH "EN" switches are capable of reliable, long-life performance under extreme environmental conditions. They are completely sealed, cylindrical and can be mounted wherever a through hole can be provided. Variations of the "EN" are capable of actuation by almost any means. Available in choice of four different contact arrangements. Equal in performance to many switches twice the size.

Switches have uses unlimited



Switches put "THINK" into this press transfer feed

Here is a typical example of how a manufacturer improved his product. With MICRO SWITCH Precision Switches designed into the press, blanks are loaded and fed automatically, dangerous manual feeding is eliminated, mistakes are "erased" without interrupting production. This product improvement was due in no small measure to the help of MICRO SWITCH application engineers.

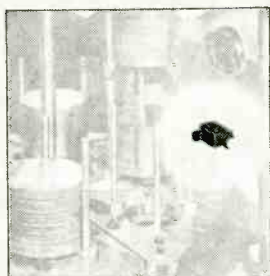

For more information for your design engineers, write for Catalog 83.

When a stack of blanks is nearly depleted, the descending elevator trips this switch which starts a motor and turns the six-station turret to the next full station for blanks.

Plunger which picks up the blanks is controlled by switches shown. Upper switch stops the press if the blanks do not reach level of gripping fingers. Switch at left brings new stack of blanks into position. If stack doesn't come into position, the third switch stops press.

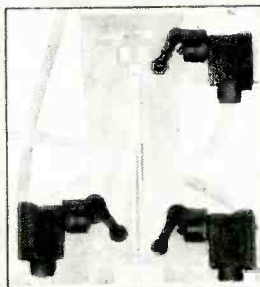

When two blanks stick together and feed into the press they trip this switch which actuates a solenoid and opens a trap door in the press bed. The blanks fall through, the press goes on uninterrupted.

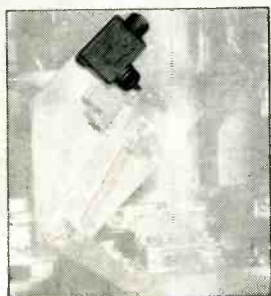

SWITCH "REMEMBERS" CIRCUIT WHICH WAS LAST ACTUATED

This is the first of a new series of "electrical memory" toggle switches. The switch indicates through a pilot light or buzzer which circuit was last actuated. The assembly uses one pole of its four-pole circuitry to indicate which circuit was last operated. Use of this switch simplifies basic circuit designs of radar units, computers, aircraft control panels and other similar devices. Seal prevents entrance of liquids and dust. Basic switches are Underwriters' Listed at 5 amperes 125, 250 volts a-c, d-c rating at 28 volts-3 amperes at sea level, 2.5 amperes at 50,000 feet (inductive); 4 amperes at sea level and 50,000 feet (resistive); maximum inrush, 15 amperes.

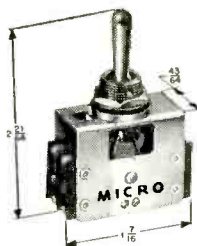

Visit MICRO SWITCH Exhibit
Booths 2202-2212
at the I R E Show
New York Coliseum
March 18-21

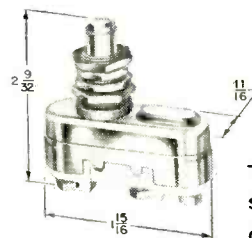

THIS SWITCH OPERATES

RELIABLY AT TEMPERATURES FROM -50° TO +1000° F

Use of laboratory-tested, heat-resistant materials makes this switch an extremely dependable component for use in applications where high temperatures are present. It will operate satisfactorily in a temperature range of -50° to 1000°F. Contact arrangements are single-pole double-throw. Switch is available in panel-mount design (shown) or with pin- or roller-plunger actuators.

(Send for Catalog 77)

A TWO-CIRCUIT SWITCH WITH ACCURATE REPEATABILITY

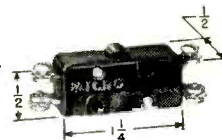

This switch uses a snap-action spring to provide quick make and break of both contacts in each double-break circuit. It is Underwriters' Listed for 10 amperes 125 or 250 volts a-c; 1/2 H.P. 125 volts a-c; 10 amperes 30 volts d-c.

(Send for Catalog 62)

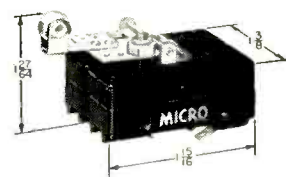

TWO SWITCHES OPERATED BY A SINGLE LEVER ACTUATOR

This is an assembly of two single-pole double-throw switches. It provides for switching of two isolated circuits at the same time. The basic units are listed by Underwriters' Laboratories at 15 amperes 125, 250 or 460 volts a-c; 1/2 ampere 125 volts d-c; and 1/4 ampere 250 volts d-c.

(Send for Data Sheet 100)

MICRO SWITCH

A DIVISION OF MINNEAPOLIS-HONEYWELL REGULATOR COMPANY

In Canada, Leaside, Toronto 17, Ontario • FREEPORT, ILLINOIS



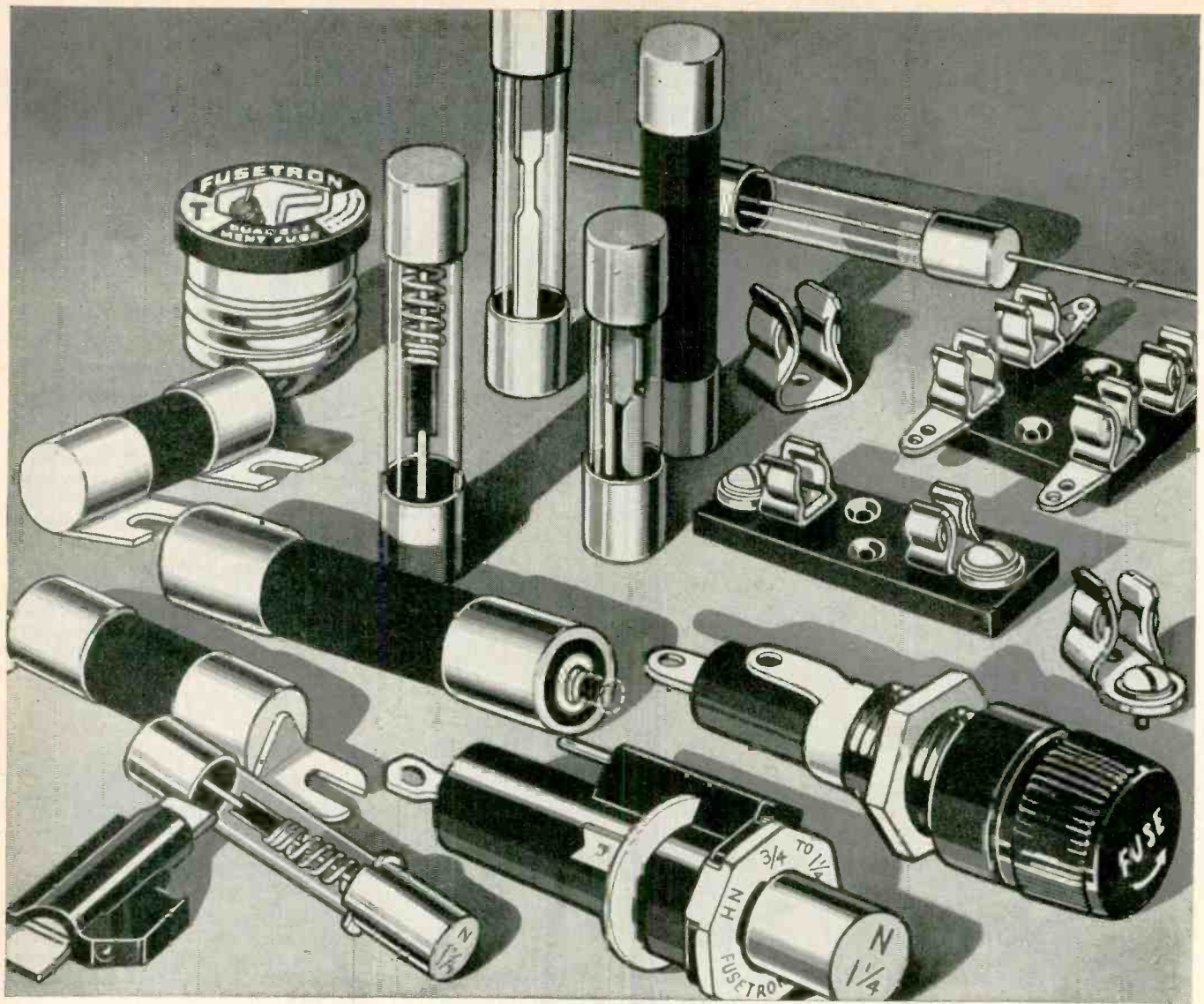

You can rely on BUSS FUSES to operate as intended.

Here's why—With BUSS fuses, dependable electrical protection isn't left to chance. BUSS fuses are tested in a sensitive electronic device. Any fuse not correctly calibrated, properly constructed and right in all physical dimensions is automatically rejected.

The result,—BUSS fuses provide maximum protection against damage due to electrical faults. And just as important, they eliminate useless shut-downs caused by faulty fuses blowing needlessly.

With a complete line of fuses available, it is just good business to standardize on BUSS. The "trouble-free" operation of BUSS fuses helps to assure that your product will operate as intended . . . thus, BUSS fuses help to maintain the reputation of your product for quality and service.

If you have an unusual or difficult protection problem, let the BUSS fuse engineers work with you and save you engineering time. If possible, they will suggest a fuse already available in local

wholesalers' stocks, so that your device can be easily serviced.

For more information on BUSS and Fusetron small dimension fuses and fuseholders . . . Write for Bulletin SFB, Bussmann Mfg. Co. (Div. of McGraw-Edison Co.), University at Jefferson, St. Louis 7, Mo.

BUSS fuses are made to protect—not to blow, needlessly



Makers of a complete line of fuses for home, farm, commercial, electronic, automotive and industrial use.

357

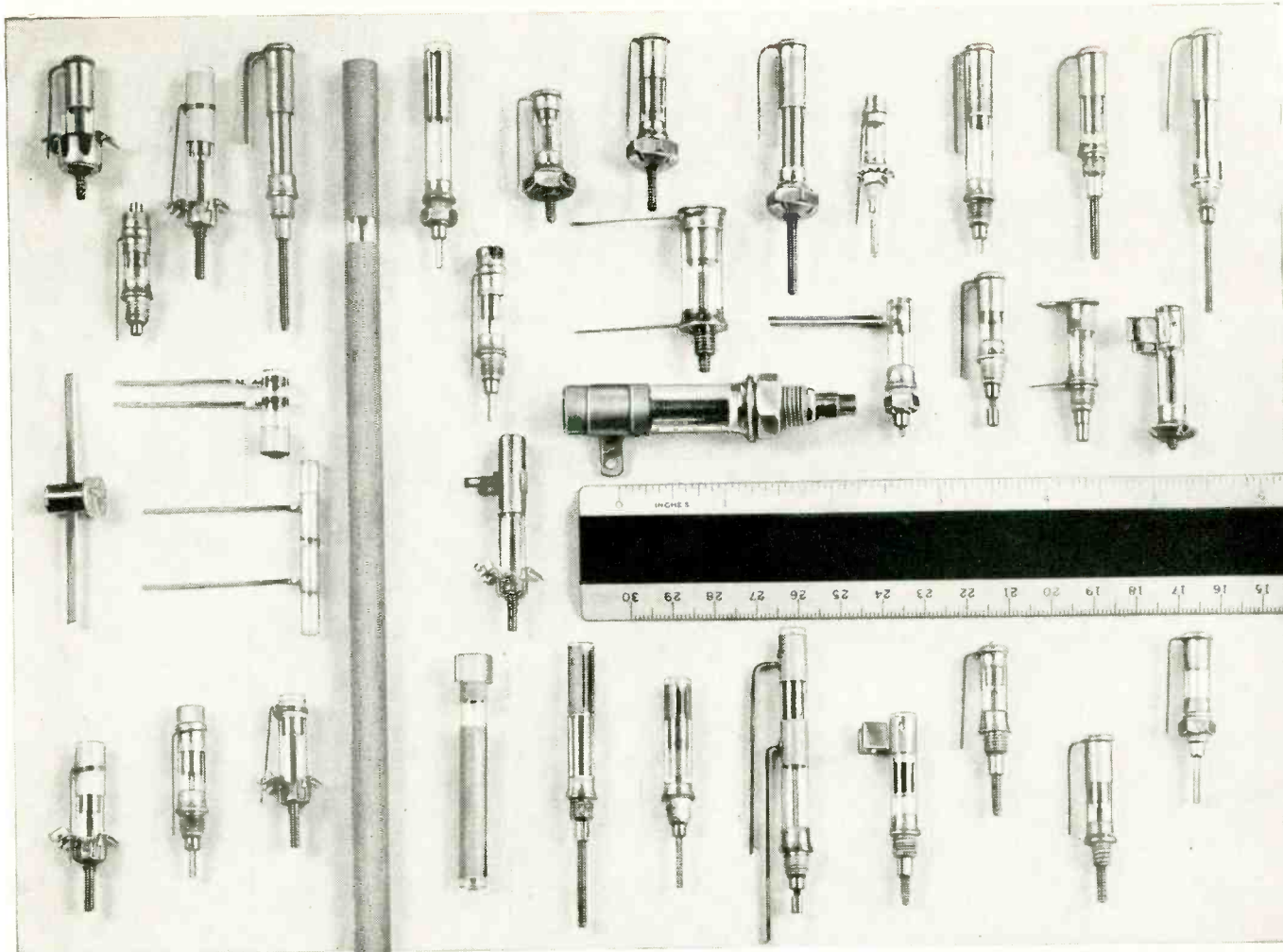

For each of the different trimmers shown, there are dozens more that we can make to give you exactly the trimmer you need—with a flat tuning curve like that shown in the drawing.

Let us put our exceptional stability in a trimmer capacitor designed for your need

Just turn your requirements over to us and we'll design the type you need around the many important features that Corning Trimmer Capacitors alone combine.

Or, if you have your design pretty much worked out and want a manufacturer, let us show you how we go about giving you what you want along with extra measures of miniaturization and stability.

Starting by permanently bonding metal to tubes of rugged glass, we give you trimmers that have negligible capacity change even when ambient temperatures vary greatly. Temperature coefficients are $+50 \pm 50 \text{ ppm}/^\circ\text{C}$. or $+200 \pm 50 \text{ ppm}/^\circ\text{C}$., depending on the core material used.

If you're working in critical applications, such as high frequency amplifiers and oscillator circuits, the Corning direct-traverse motion will simplify tuning. Because the tuning slug moves in and out

without turning, you get no reverse loops. A mushroom end spring eliminates microphonics and capacity shift under vibration.

Or, if you're interested more in the general high frequency range, you can get Corning trimmers with rotary tuning slugs. This economical design comes in a wide variety of mounting styles, push-on mounts, and split bushings, with saddle clips, wire leads, pan terminals or solder spots.

You can get both the direct-traverse type and the rotary style in ratings from .3 to 12.0 mmfd. to your design. You can also get a capacity range of from 2 to 30 mmfd. in a slightly larger version of our

TUNING CURVE FOR CORNING 1 TO 8 MMFD. DIRECT TRAVERSE TYPE TRIMMER CAPACITOR
Check made at 50.0 MCS. on Bonton 160-A QMeter

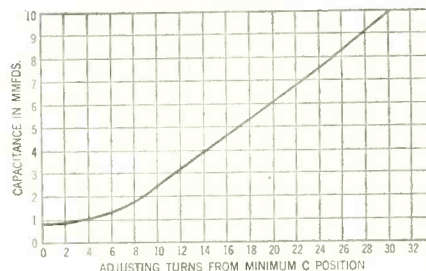

direct-traverse motion.

Whatever you need, write, wire, or phone Corning for facts on how we can help you. If you'd like more information, circle the publisher's inquiry number for catalog sheets.

Other electronic products by Corning Components Department: Fixed Glass Capacitors*, Transmitting Capacitors, Canned High-Capacitance Capacitors, Subminiature Tab-Lead Capacitors, Special Combination Capacitors, Direct-Traverse and Midget-Rotary Capacitors*, Metallized Glass Inductances, Resistors.

*Distributed by Erie Resistor Corporation



CORNING GLASS WORKS, 94-3 Crystal Street, CORNING, N. Y.

Components Department, Electrical Products Division

Corning means research in Glass

new...from Raytheon

TEST JACKS

Now the most complete quality line in the industry . . .

All your test jack needs from one reliable source—Raytheon. These brand new components offer a unique combination of highly desired features. Nine colors. Nylon insulators. Beryllium-copper contacts with silver-plated gold-washed solder terminals. Designed for extreme salt spray, humidity, temperature conditions. For standard .080" prods. These jacks conform to military specs. and are **competitively priced.**

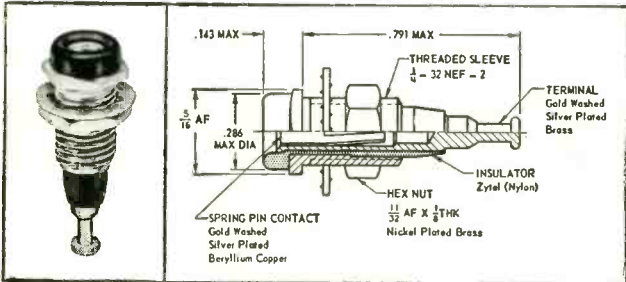

STANDARD TEST JACK

Rugged construction, superior design. Ideal for extreme shock and vibration conditions

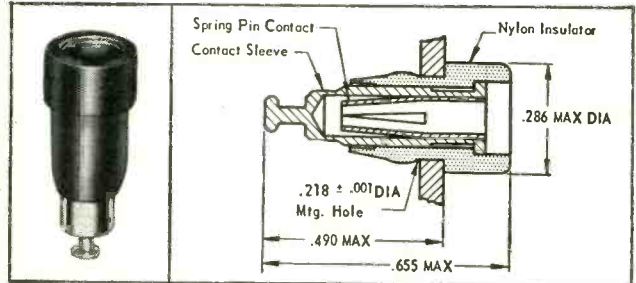

SUBMINIATURE FIXED-CONTACT TEST JACK

Fast, easy, press-fit assembly

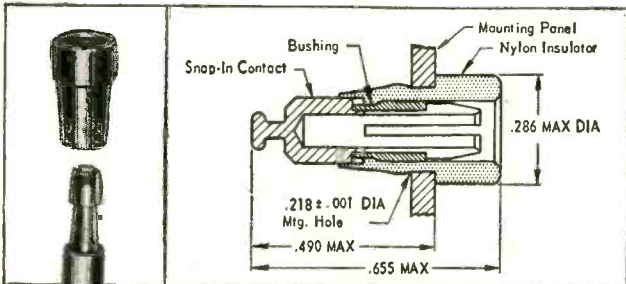

SUBMINIATURE SNAP-IN CONTACT JACKS

Snap-in contact can be soldered to cable before insertion in mounted jack

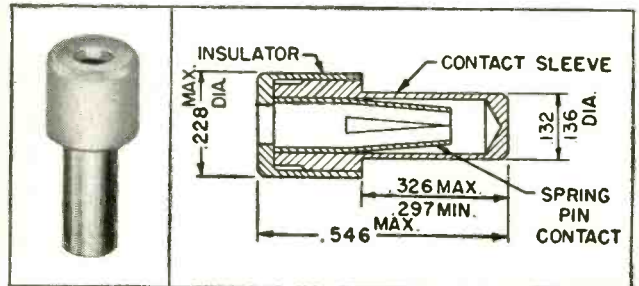

PRINTED CIRCUIT TEST JACKS

Mount on any panel to 1/4" thick

For complete information, please write Dept. 6120



RAYTHEON MANUFACTURING COMPANY
Commercial Equipment Division
Waltham 64, Mass.

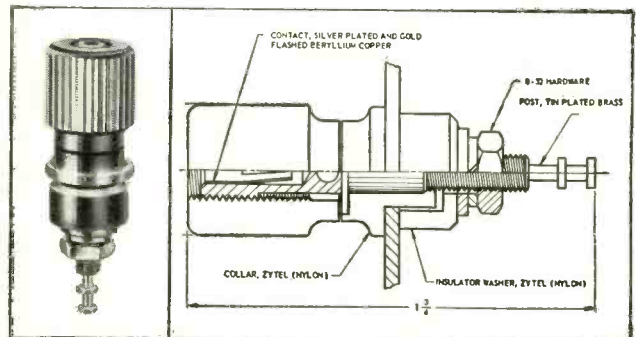

5-WAY BINDING POST

Compact, high strength. Incorporates jack for banana plug or standard .080" prod. Available in black or red

See Raytheon's exhibit at Booth 2611-14 at the I.R.E. Show



How many Toroids do you need?

WRITE FOR OUR BROCHURE
Standard inductances listed therein are available for immediate delivery.

To speed fulfillment of your orders, CAC has stockpiled standard inductances of molded plastic toroids. They are in inventory, ready for shipment hours after receipt of your orders.

Additionally, our new small orders department facilitates speedy manufacture and handling of special prototype quantities which are not stockpiled.

For Precision — Delivery — Quality — you can depend on CAC.



World's Largest Exclusive Producer of Toroidal Components

There is a CAC man near you—write, wire or phone for complete information.

Communication Accessories Company

HICKMAN MILLS, MISSOURI

PHONE KANSAS CITY, SOUTH 1-6111

Get what you really need in oscillographic recording

... with a **SANBORN "150"**

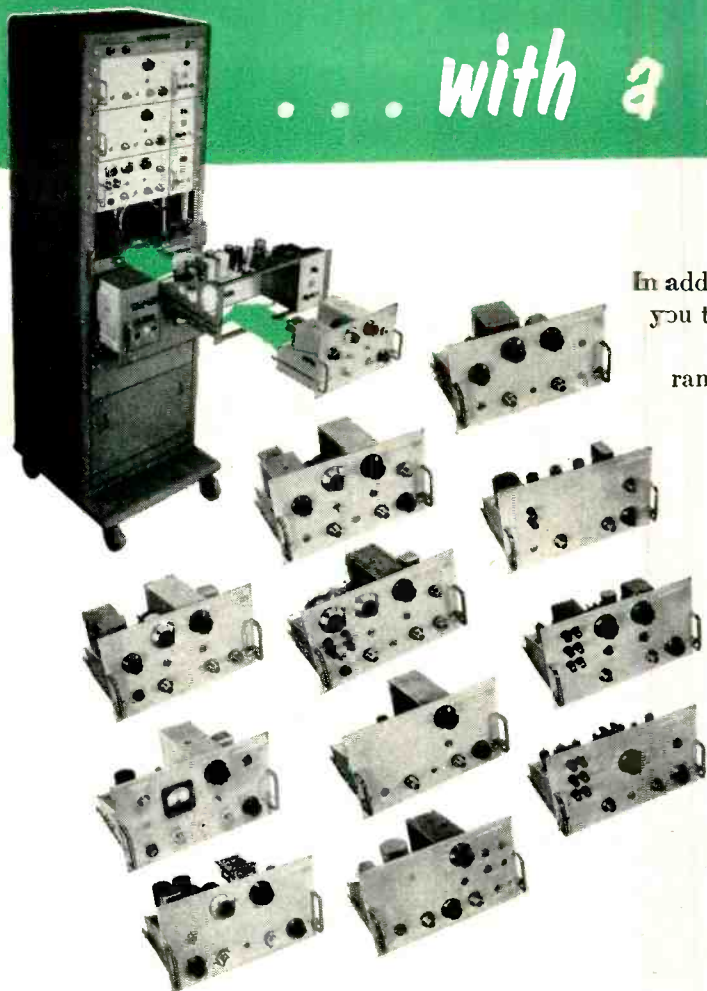

The specific advantages common to all Sanborn "150" systems are shown at the right. In addition, the fundamental design of the Sanborn "150" allows you to purchase and set up *only* what you need for your direct-writing oscillographic recording needs (in the 0-100 cycle range). There are no standard "150" recording systems. Each system in use today comprises (1) a basic assembly in the number of channels the user needs, and (2) a *choice* of interchangeable preamplifiers according to the nature of the immediate or anticipated measurements desired to be recorded by the user.

For example, the purchaser first selects either a 1, 2, 4, 6 or 8 channel Basic Assembly, each of which comprises a complete Recording Assembly in a metal mobile cabinet (or portable cases if 1-channel), a Paper Take-up Unit, and for each channel a Driver Amplifier with frame and Power Supply including Control Panel. Each Driver Amplifier is designed to receive, by simple plug-in connections, any of the eleven currently available Preamplifiers listed below.

To complete his "150" Recording System, the user then purchases the interchangeable Preamplifiers designed specifically for his recording requirements. Available "150" Preamplifiers cover a wide range of uses and include: AC-DC Carrier, Servo Monitor, Low Level DC Coupling, Log Audio, Chopper Stabilized DC, AC Wattmeter, RMS Volt/Ammeter, 400 cycle Frequency Deviation, and Frequency Meter. For those who wish to build special Preamplifier circuits to their own design, a Blank Preamplifier Chassis is available which may be used along with any of the standard Preamplifiers mentioned above.

AT I. R. E. SHOW

Booths 3601 and 3603

Dynamic display of differential transformers and velocity transducers, along with complete display and demonstration of Sanborn recording systems with interchangeable preamplifiers.

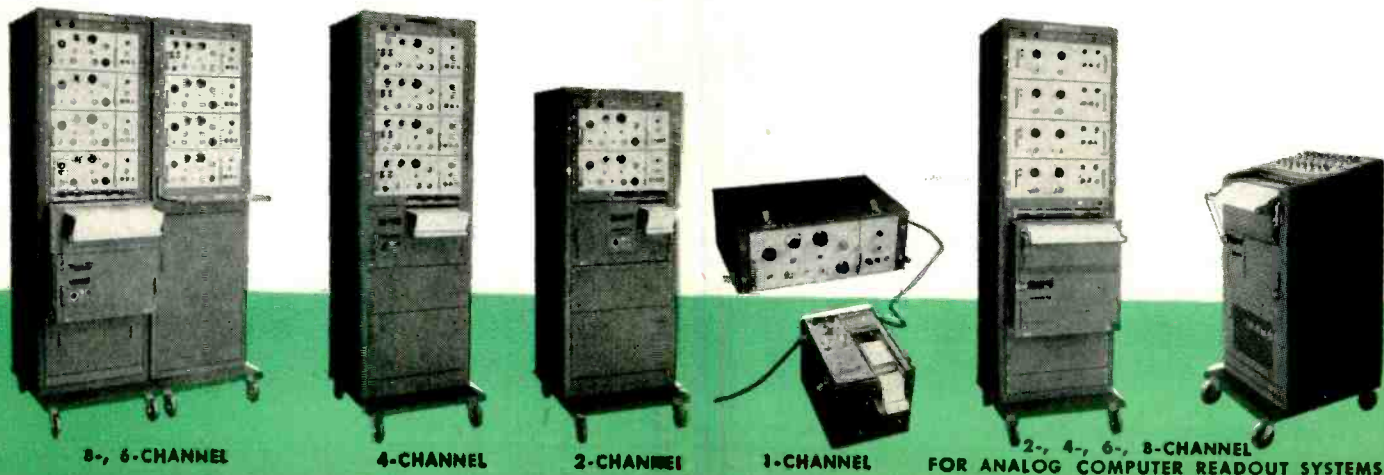

8-, 6-CHANNEL

4-CHANNEL

2-CHANNEL

1-CHANNEL

2-, 4-, 6-, 8-CHANNEL
FOR ANALOG COMPUTER READOUT SYSTEMS

**TRUE RECTANGULAR
COORDINATE RECORDING . . .**

Sanborn "150" recordings save you valuable analysis time, and minimize the possibility of errors in interpretation, by presenting data in true rectangular coordinate form. Without waveform curvature, "negative" time lines, etc., traces in multi-channel records can be easily and accurately correlated, during as well as after recording.

1% LINEARITY . . .

To meet your requirements for accurate recordings, Sanborn 150 systems provide over-all linearity of 1%. This is accomplished by current feedback driver amplifiers (one in each channel), and galvanometers of new design, featuring high torque (10 ma develops 200,000 dyne cm) and shorted coil frames. Maximum error over middle 4 cm of chart is 0.25 mm; over entire 5 cm chart width, 0.5 mm. Hysteresis effects have also been reduced in the recording galvanometer assembly, to further improve over-all recording accuracy.

**CLEAR, SHARP,
INKLESS RECORDING . . .**

A third basic feature of all "150" recordings is that they are inkless, produced by hot ribbon stylus on heat-sensitive Sanborn Permapaper. The stylus removes the white opaque surface of the chart leaving the black undercoating to show through. Permanent and smudge-proof, the traces are characterized by sharp, blot-free peaks and notches.

For useful data on the 150 Series systems and equipment to meet your needs, write to Sanborn outlining your application requirements.

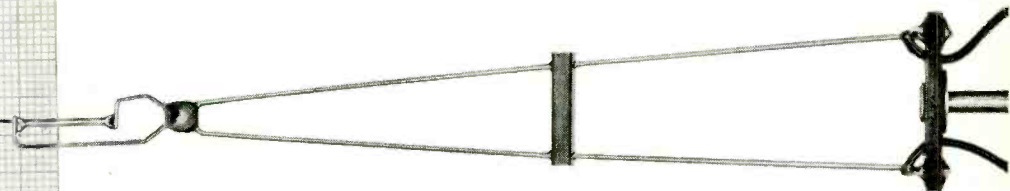

SANBORN COMPANY

WALTHAM 54, MASSACHUSETTS

INDUSTRIAL



DIVISION

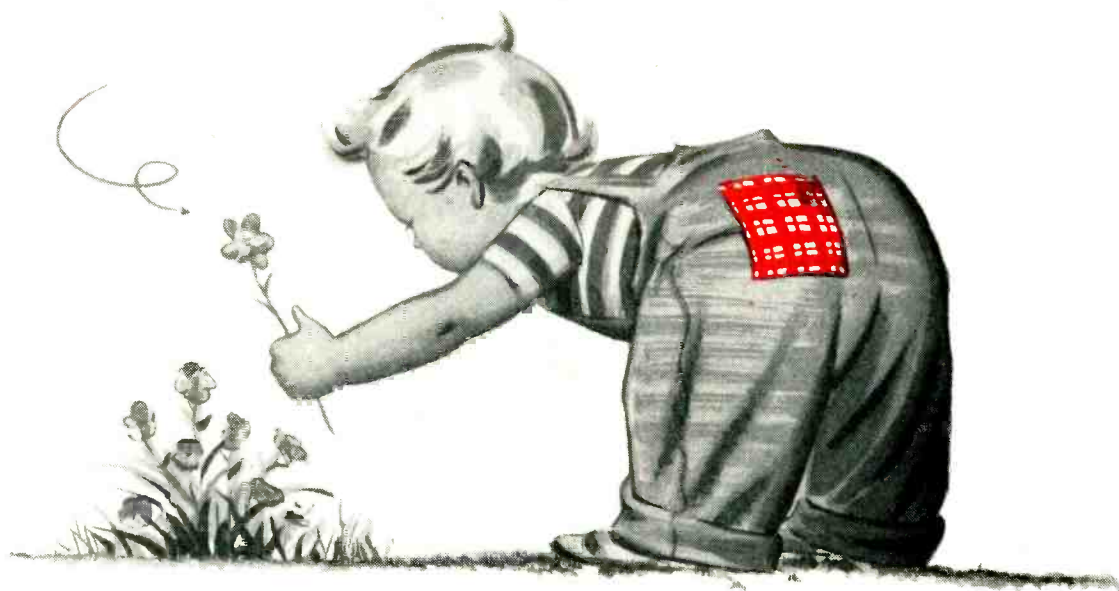

Patchwork has its place but . . .



In an era of stepped up competition, no manufacturer can hope to keep pace with the field while relying on obsolete "patchwork" instrumentation. . . . Almost hourly, electronics research is spawning new instruments designed to perform a specific function better, in less time, at lower cost.

But here's where your independent FIRST SIX* manufacturers' representative enters the picture. He represents what's new, what's right in electronic product design. What's more he's technically qualified to recommend and apply industry's newest product innovations advantageously to your instrumentation problems.

Today, "patchwork" — won't work! Better call in your independent FIRST SIX sales engineer. He'll back up his lines with a full measure of intelligent technical service . . . from recommendation to maintenance!

* THE FIRST SIX — Six leading, independent manufacturers' representatives functioning cooperatively for the advancement of improved electronic instrumentation in industry.

A. CROSSLEY ASSOC., INC.

Chicago, Ill.
Dayton, Ohio
St. Paul, Minn.

THE I. E. ROBINSON CO.

Philadelphia, Pa. — (Upper Darby)
Camp Hill, Pa.
Asbury Park, N. J.

S. STERLING CO.

Detroit, Mich.
Cleveland, Ohio
Dayton, Ohio

HORMAN ASSOC., INC.

Washington, D. C.

J. D. RYERSON ASSOC., INC.

Syracuse, N. Y.

YEWELL ASSOC., INC.

Burlington, Mass.
Bridgeport, Conn.

DeJUR precision potentiometers

**...THE ONE
BEST ANSWER
TO YOUR
DESIGN
PROBLEMS**

SERIES C-050

SUB-MINIATURE ½" • SEALED CONSTRUCTION

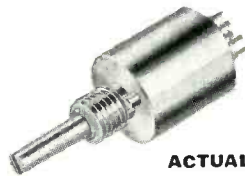

ACTUAL SIZE

- One piece nickel plated bronze case and bearing.
- Electrical rotation—320°; Mechanical rotation—325°, or continuous 360°
- Voltage breakdown—1000 volts AC.
- Threaded bushing mounting.

SERIES C-078

MINIATURE ¾" • GANGED MULTIPLES • INDEPENDENT PHASING

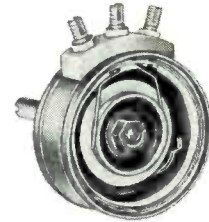

ACTUAL SIZE



- Unit height ¾"; weight ½ oz.
- Independent linearity: ± 1% is standard.
- Linear or non-linear windings on flat card; res. tol. — ± 5% std., ± 1% on order.

SERIES C-158

INTERMEDIATE 1¼" • GANGED MULTIPLES • INDEPENDENT PHASING



½" ACTUAL SIZE

- Independent linearity: ± 0.5% of total resistance is standard.
- Linear or non-linear windings std., ± 1% on order.
- on flat card; res. tol. — ± 5%
- Rotation: electrical — 320°. Mechanical—325°.

SERIES C-200 (sleeve bearing) BC-200 (ball bearing)

IN-FIELD GANGING • UNLIMITED MULTIPLES • ADJUSTABLE TAPS



2" DIAM.

- Resistance ± 5% standard; to ± 1% on special order.
- Linearity: ± 0.5% independent linearity is standard; ± 0.3% on special order for C-200; ± 0.2% on special order for BC-200.
- Mounting: Servo type or single hole mounting with optional non-turn device.

SERIES C-300

SINE-COSINE



3" DIAM.

- Independent brush contacts produce accurate sine and cosine outputs.
- Function accuracies of ± 1% are standard.
- Multiple ganged units are available.

SERIES KS-200 (sleeve bearing) K-200 (ball bearing)

LONG FUNCTION ANGLES • CLAMP PHASING • HIGH RESOLUTION



2" DIAM.

- Resistance: linear, on triple Formvar copper mandrel.
- Independent linearity: ± 0.5% is standard; ± .1% on order.
- K-200 pots are completely enclosed and may be used as single or multiple ganged units.

SERIES HP-200, HP-300, HP-500

HIGH RESOLUTION • LONG FUNCTION ANGLES • GANGING MULTIPLES



2", 3", 5" DIAM.

- Linearity: ± .5% standard to ± .1% on order.
- Resistance: ± 5% standard to ± 1% on order.
- Rotation: 360° mechanical; 356° ± ½° electrical standard.

WRITE FOR COMPLETE TECHNICAL LITERATURE

Our engineering department can supply prototypes to meet unusual design specifications for tests and approval. Send us your specs for analysis. Electronic Sales Division, DeJUR-Amsco Corporation, 45-01 Northern Blvd., Long Island City 1, New York.

*You're
always
sure
with*

DeJUR

PRECISION POTENTIOMETERS

See our complete line at
Booth 3911-13, I.R.E. Show

Continental Connectors

AMERICA'S FASTEST GROWING LINE

*featuring the most important
connector developments in recent years*

SEE CONTINENTAL AT BOOTH 3911-13, I.R.E. SHOW

PRINTED CIRCUIT CONNECTORS with "BELLOWS ACTION CONTACTS"

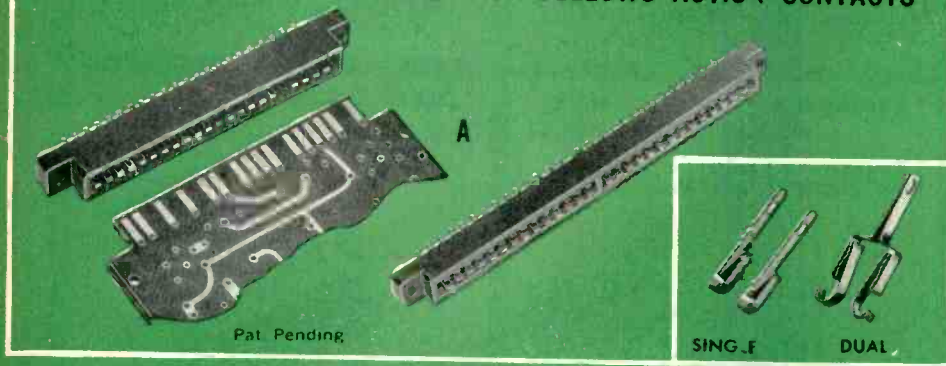

MICRO-MINIATURE CONNECTORS
ACTUAL SIZE

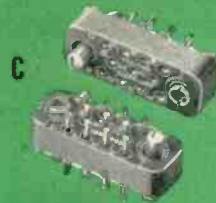

SUBMINIATURE CONNECTORS
ACTUAL SIZE

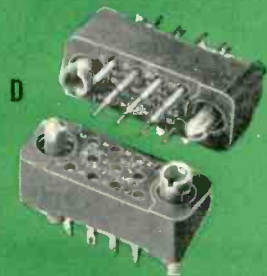
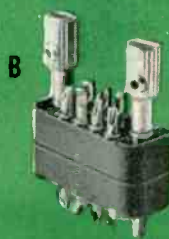

Patent #2746022

PRINTED CIRCUIT CONNECTORS A) New Series PC "Bellows Action Contacts" grip printed circuit board over 100% of board contact area. Contacts in single or double rows permit up to 56 connections. AA) Right Angle Printed Circuit Pin and Socket Connectors for dip soldering to printed circuit boards. Available in 4, 8 and 19 contacts.

B) POLARIZING SCREWLOCKS to prevent accidental disconnection due to vibration now available in Series 20 Miniature and Series SM-20 Subminiature Continental Connectors.

C) SERIES 22 MICRO-MINIATURE Connectors offer the ultimate in miniaturization without sacrifice of performance. Available with 7, 11, 14, 20, 26, 29 and 34 contacts for #22 AWG wire. Rating: 3 amps; Voltage: 1800V. RMS.

D) SERIES SM-20. Model shown has 11 contacts for #20 AWG wire. Available in 7, 11, 14, 20, 26 and 34 contacts. Rating: 5 amps; Voltage: 1900V. RMS.

E) SERIES 20 MINIATURE CONNECTOR with Hood and Polarizing Screwlocks. Available with 7, 8, 9, 11, 14, 18, 20, 21, 26, 34, 41, 50, 75 and 104 contacts for #20 AWG wire. Rating: 5 amps; Voltage 2100V. RMS.

F) SERIES 20 with 50-ohm matched impedance coaxial contacts and 14 or 18 standard #20 contacts. Rating: 5 amps; Voltage: 2100V. RMS.

G) SERIES CCC 20 in stainless steel shells, recommended for airborne applications. 37 contacts for #20 AWG wire. (15 and 25 contacts on request.)

H) SERIES E-Z Easy Release Connectors with up to 34 solder cups or solderless taper pin contacts. Aluminum hoods, polarizing screwlocks and coaxial contacts available on order. Rating: 10 amps; Voltage: 4500V. RMS.

High precision, dependable Continental Connectors have achieved a reputation for excellence throughout the aircraft and electronics industries. The widest range of applications can be made from our standard line.

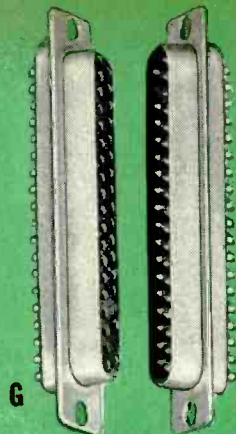
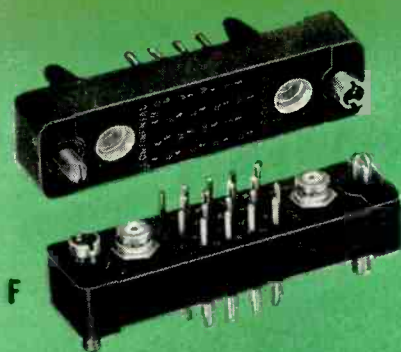
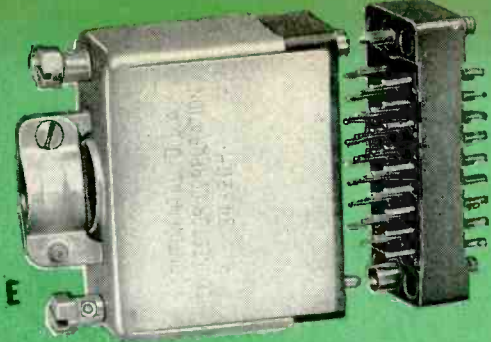

CONTINENTAL "SERIES 20" MINIATURE CONNECTORS

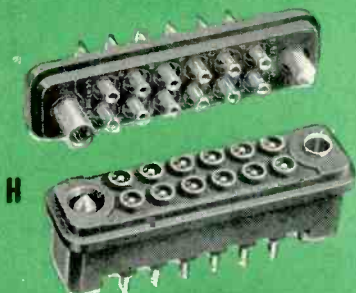

EASY RELEASE

Patent #2736870



MINIATURE AN-TYPE



HERMETIC SEAL CONNECTORS

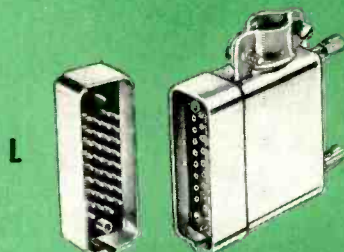

PROTECTIVE SHELLS

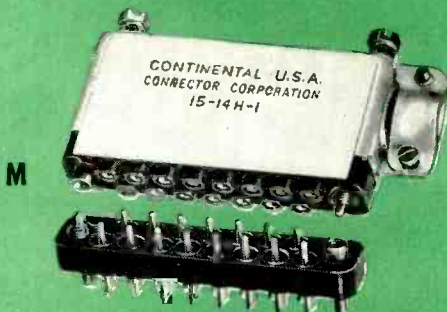

POWER CONNECTORS

TAPER PIN TERMINAL BLOCKS



SINGLE ROW

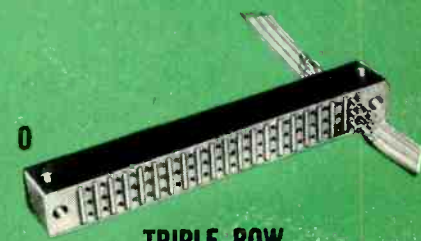

TRIPLE ROW

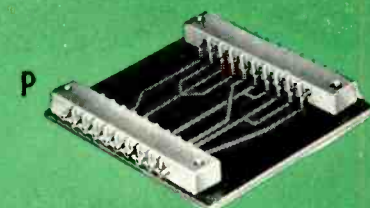

RIGHT-ANGLE CONNECTOR

I) SERIES 1300 MINIATURE AN-TYPE Connector with one-piece molded inserts. Rating: 7.5 amps; Voltage: 3000V. RMS. Two shell sizes: 3, 4, 5 contacts, and 15, 19, 27, 31 contacts.

J) SERIES HC-20 HEXAGONAL Hermetic Plug has solid glass insert. Choice of 4, 5, 7, 9 and 10 contacts.

K) SERIES H-20 Hermetic Plug for #20 AWG wire. Contacts individually compression sealed in glass. Fits Series 20 receptacles. With polarizing screwlock or guide pin and guide socket.

L) ANODIZED ALUMINUM SHELLS give complete protection against physical damage on Miniature Series 20 and Subminiature Series SM-20. Obtainable with or without corrosion-resistant stainless steel polarizing screwlocks.

M) SERIES 14 Power Connector (illustrated with hood and polarizing screwlock.) Choice of 7, 9, 10, 15 or 18 contacts for #14 AWG wire. Rating: 10 amps; Voltage: 4500V. RMS.

N) SERIES 145-58 Single Row Taper Pin Terminal Blocks. Available in any combination of feed-through shorting or non-shortening terminals. Molded holes for stacking or mounting.

O) SERIES 145-48 Triple Stacked Taper Pin Terminal Blocks. Continental will supply stacked taper pin blocks in any combination of feed-through shorting or non-shortening terminals. Molded holes for right angle and perpendicular mounting.

P) SERIES 145-60 Taper Pin Terminal Blocks for Printed Circuitry. Precision tapered molded-in right angle terminals for dip soldering to printed circuit boards.

For special designs and technical data sheets on these connectors write Electronics Sales Div., DeJur-Amsco Corporation, 4501 Northern Blvd., Long Island City 1, N. Y.

you're
always
sure
with

DeJUR

the Series —



TYPE

403

Highest sensitivity
oscilloscope commercially
available. DC amplifier
1 mv full scale sensitivity.

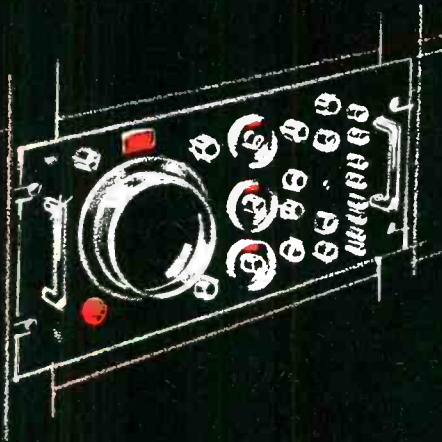

TYPE

407

Transistorized low-noise
pre-amplifier. Gain of 10.
Battery operated. Self-contained.
Size 4" x 3½" x 4⅞". Frequency
response: 0.15 cps to 10 kc.

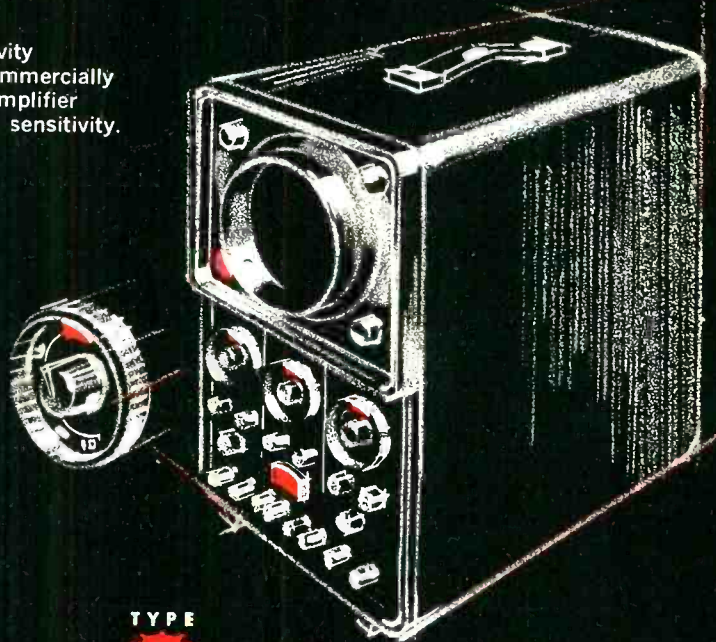

TYPE

401

High gain. DC-150KC.
Identical X- and Y-amplifiers.
Calibrated sweeps.

Sparkling new ideas materialize in the DuMont 400 Series. These 6 new instruments are *current* models, ready right now. See and operate these instruments at the New York I.R.E. Show. Or ask for a demonstration at your convenience. Write for complete details.

6 ready now

TYPE

404

Jitter-free, hard-tube
circuitry pulse generator.
Pulse repetition rates
up to 100,000 pps.

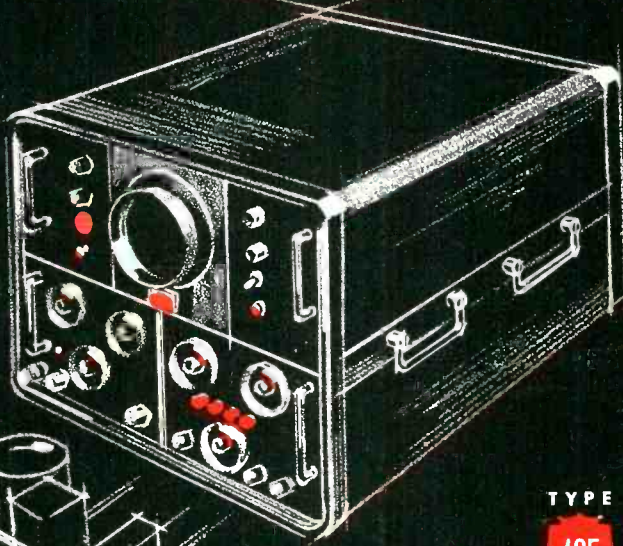
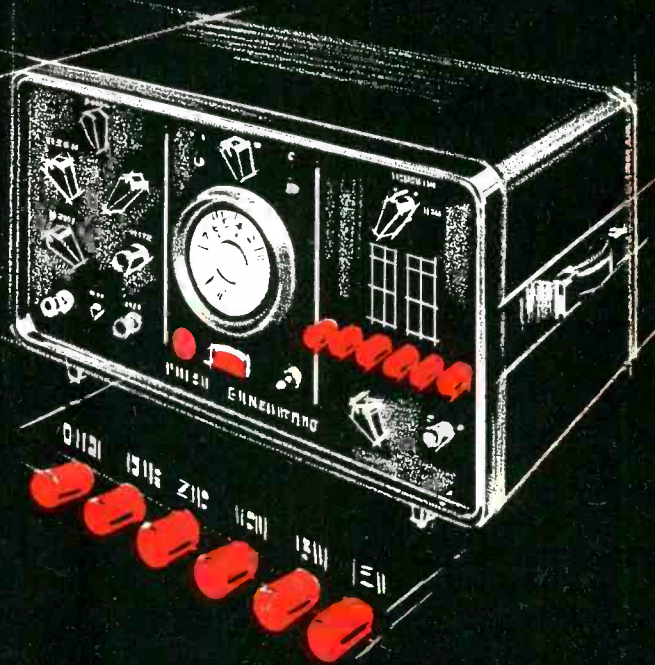

TYPE

405

AC-DC VTVM. Dual and
differential input. 0.1
volt full scale AC or DC.
121 megohm resistance on
DC. AC performance to UHF.
Storage compartment for probes.

TYPE

410

High gain DC amplifier with
7 millimicrosecond rise time.
High duty cycle calibrated sweeps.
24 KV accelerating potential. Building
Block construction allows choice
of performance characteristics.

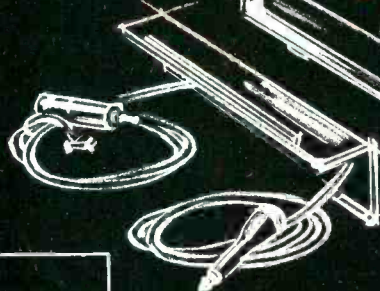
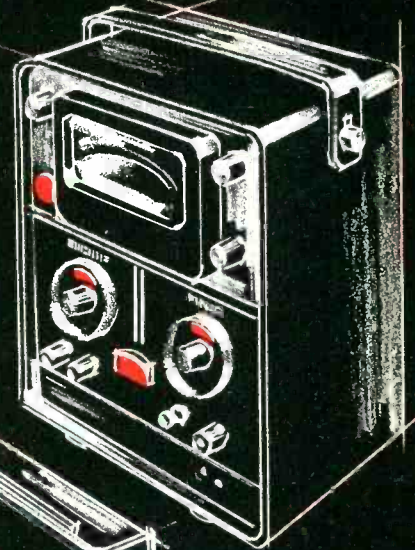

WARRANTY

Every instrument in the DuMont 400 Series
carries a five-year guarantee.

DU MONT®

Technical Products Division, Allen B. Du Mont Laboratories, Inc., 760 Bloomfield Ave., Clifton, N. J., U.S.A.

WHY MORE THAN 500 ENGINEERS CALL IT

"MY AIRPLANE"

Successful weapons and well-rounded engineers have a common denominator at Chance Vought. It's Vought's "project-group" system, a highly-effective brand of development teamwork that makes each engineer an inside man in the over-all development picture. On Vought's record-breaking Crusader fighter, the system worked like this:

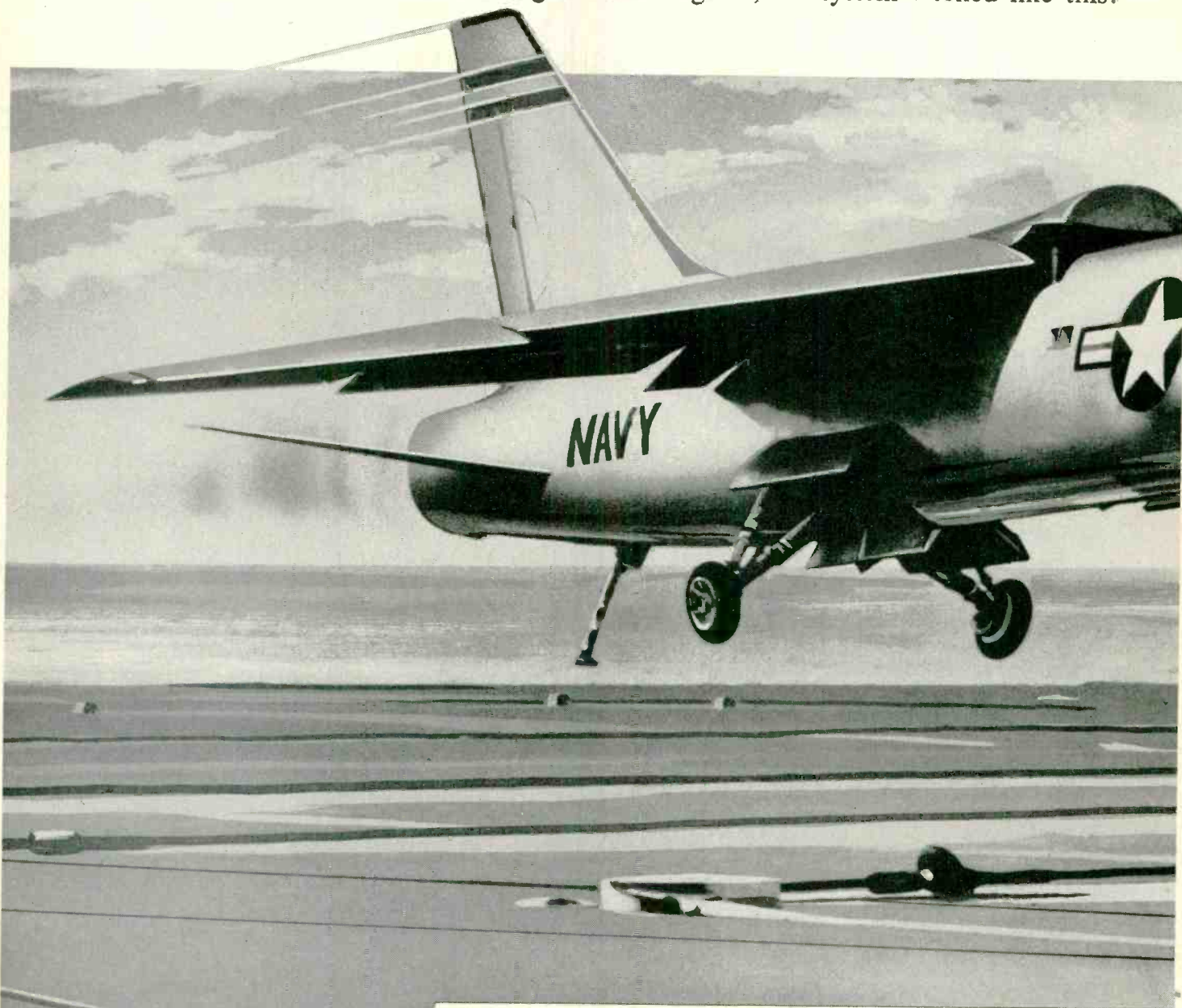

In Vought's project-group system there's advancement opportunity for experienced project men, technical specialists and junior engineers alike. Arrange to visit Chance Vought for a firsthand investigation. Or, for a report on our openings,

write to:
Mr. J. W. Larson
Asst. Chief Engineer
Dept. E-2

Engineers selected from their original groups for the Crusader project followed their assigned systems and sub-assemblies from preliminary design to flight test. Teamed with engineers from other groups, they lent mutual assistance, worked outside their own specialties, and enlarged their view of the program. At the same time, liaison was maintained with the original groups on methods, research and policy. This

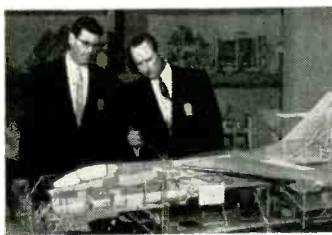

way, the Crusader became everyone's aircraft, and everyone learned. That's the value of the project-group system. Linking group with project, it coordinates the state of the art with the practical problems of project work. Joining engineers of one specialty with those of another, it offers each a better compromise and a wider view.

Turn tax savings into family fun in Dallas

You pay neither sales tax nor city and state income tax in Dallas. You can use these savings as Dallasites do — on outdoor fun for the family. Lakes, links and ranches are close at hand, and the Gulf's within an easy half-day's drive.



5 IMMEDIATE OPENINGS FOR ENGINEERS

Systems Engineer for Design and Test of Radar, Fire-control, Infrared, Communications and Navigation Systems. Requires engineering degree or equivalent, plus one to four years related experience.

Package Designers for Electronic Equipment. Mechanical or Electrical Engineer to design the package and structure of antenna, stabilization and other electronic equipment. Requires engineering degree, or equivalent. Related experience desirable.

Electronics Engineer for Flight Test Instrumentation. Assignments on Crusader and Regulus missile programs, involving telemetering, automatic and semiautomatic data reduction, oscillographic and magnetic tape circuits. Requires engineering degree, or equivalent.

Systems Engineer. For design and test of electro-hydraulic and hydro-mechanical servo control systems. Requires engineering degree, or equivalent, plus one to four years related experience.

Electronics Designer for Missile and Piloted Aircraft Check-out Equipment. Desire designer with E.E. degree or equivalent, plus two to five years electrical or electronic design experience.

CHANCE

VOUGHT AIRCRAFT
INCORPORATED

Dallas, Texas

**EFFICIENT
HEAT
TRANSFER
WITH**



*... an internal thermal gradient
of 1.2° C/watt or less!*

Industry's Highest Power Transistors

Large area, thinness and intimacy of collector contact with large copper base provide the efficient thermal transfer.

Result—an unusually cool collector junction in the Delco Radio alloy-type germanium PNP power transistor. The Delco Radio 2N173 and 2N174 transistors not only have high power handling ability but also low distortion characteristics. Thus, they are ideal for audio as well as your general power applications.

Furthermore, these transistors are normalized to retain their performance characteristics regardless of age. Write for engineering data. Delco Radio transistors are produced by the thousands every day.

TYPICAL CHARACTERISTICS

	2N173	2N174
Properties (25°C)	12 Volts	28 Volts
Maximum current	12	12 amps
Maximum collector voltage	60	80 volts
Saturation voltage (12 amp.)	0.7	0.7 volts
Power gain (Class A, 10 watts)	38	38 db
Alpha cutoff frequency	0.4	0.4 Mc
Power dissipation	55	55 watts
Thermal gradient from junction to mounting base	1.2°	1.2° °C/watt
Distortion (Class A, 10 watts)	5%	5%

DELCO RADIO

**DIVISION OF GENERAL MOTORS
KOKOMO, INDIANA**

IMPORTANT NEWS

for design engineers



WHAT IS YOUR CAPACITOR APPLICATION PROBLEM?

We'll be glad to advise you.

Make your own test of El-Menco Dur-Mica Capacitors

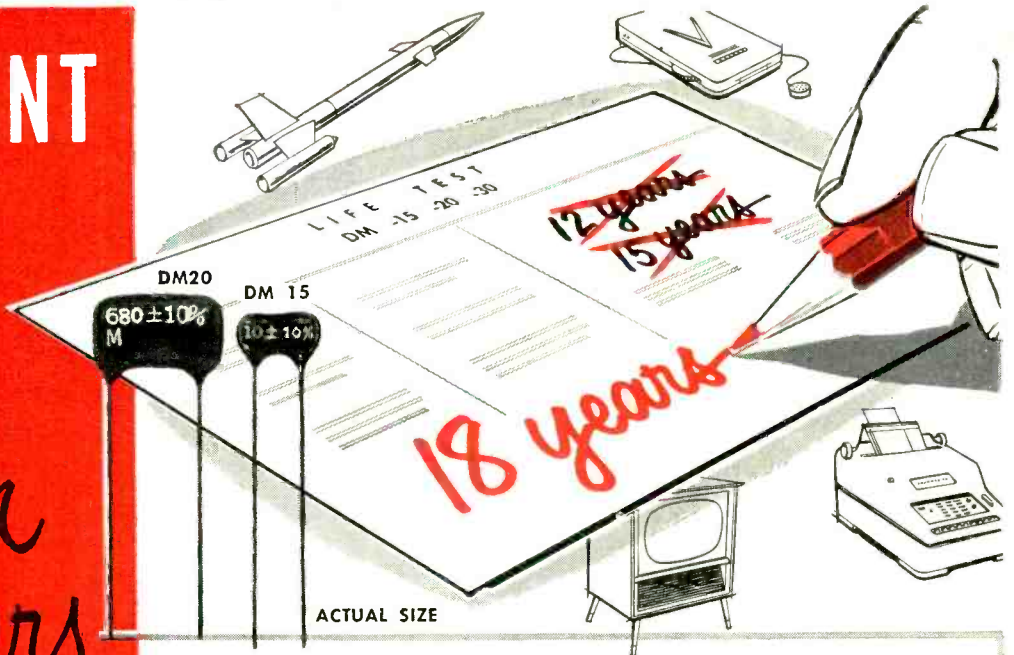

El-Menco Dur-Micas

now rated for even

LONGER LIFE!

El-Menco Dur-Mica Capacitors Can Now Assure You Of Dependable Performance Up To 18 Years!

Not An Extravagant Claim, But A Tested Fact. The latest series of rugged trials by El-Menco engineers found El-Menco DM15, DM20 and DM30 Dur-Mica Capacitors outlive and outperform all others. Under accelerated conditions of 1½ times rated voltage at 125°C ambient temperature; El-Menco capacitors continued to perform reliably after 12,000 hours. Translated into normal conditions, this indicates a lifetime of from 15 to 20 years!

MEET ALL ENVIRONMENTAL AND ELECTRICAL REQUIREMENTS OF BOTH CIVILIAN AND MILITARY SPECIFICATIONS.

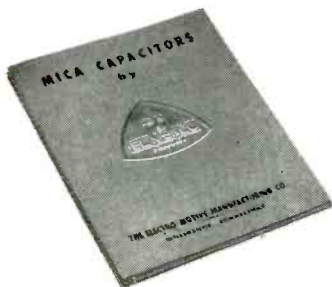

Write for FREE samples and catalog on your firm's letterhead.

El-Menco Dur-Mica DM15, DM20 and DM30 Capacitors Mean:

1. LONGER LIFE
2. POTENT POWER
3. SMALLER SIZE
4. EXCELLENT STABILITY — SILVERED MICA
5. PEAK PERFORMANCE

In addition to longer life, El-Menco Dur-Mica Capacitors with tougher phenolic casing assure greater stability over wide temperature range.

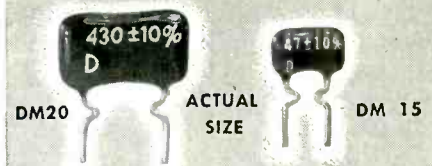

WITH NEW CRIMPED LEADS. Crimped, parallel leads simplify application in television, printed circuits, electronic brains, computers, guided missiles and other civilian and military uses.

El-Menco

Capacitors

THE ELECTRO MOTIVE MFG. CO., INC.

- | | |
|-----------------|------------------------|
| WILLIMANTIC | CONNECTICUT |
| • molded mica | • mica trimmer |
| • tubular paper | • ceramic |
| | • silvered mica films. |

Arco Electronics, Inc., 64 White St., New York 13, N. Y.
Exclusive Supplier To Jobbers and Distributors in the U.S. and Canada

Special 111-conductor Rome cable solves tough guided missile problem

When project engineers at North American Aviation, Inc., needed a special telemetering cable for their advanced guided missile work at various missile test centers, Rome Cable Corporation was asked to make it.

The cable was a tough one to manufacture. The specifications called for exacting dielectric requirements, low-loss characteristics, adequate service life—and a total of 111 conductors—all contained by one heavy-duty jacket.

Because Rome Cable engineers are accustomed to solving tough cable problems like this, they readily produced the cable which met North American's rigid specifications. Rome RoLene—a polyethylene compound—proved perfect for insulating the 37 triplets inside the jacket, and it easily met the specification requirements calling for controlled capacitance and uniform wall thickness. Rome Synthinol, a tough polyvinyl chloride compound, proved to be an excellent jacket material.

Rome Cable can also help you
You can turn to Rome Cable with

confidence for the right solution to *your* special cabling problems. Rome's competence in its field is, in part, a function of the following factors:

1. Engineering experience. Rome engineers regularly handle complicated specification problems. They've had years of experience dealing with electronic circuit problems.

2. Complete production facilities. The completeness of Rome Cable's manufacturing facilities is unique.

3. Uncompromising quality control. Latest devices, like the photoelectric gauge, are regularly used to assure highest quality. This particular gauge enabled Rome to maintain an exacting control on the diameter limits of insulations and jacket for this special cable.

Rome Cable's engineers can probably be of real help to you on your next cable problem, especially if it is a really tough one. For more information as to what we can do to help you, simply contact your nearest Rome Cable representative—or write to Department 850, Rome Cable Corporation, Rome, N. Y.

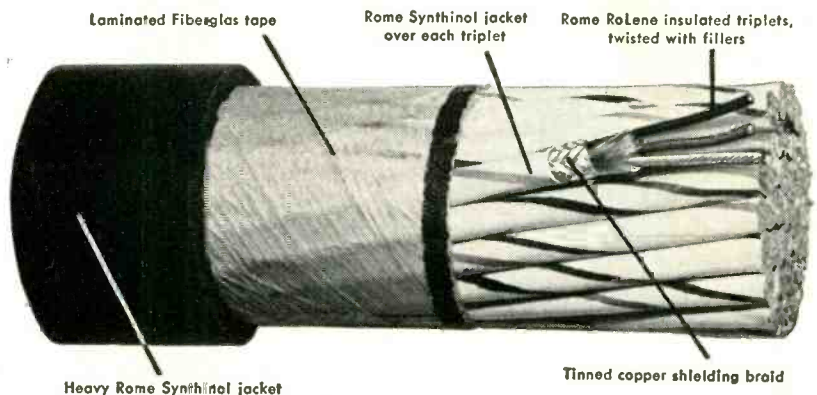
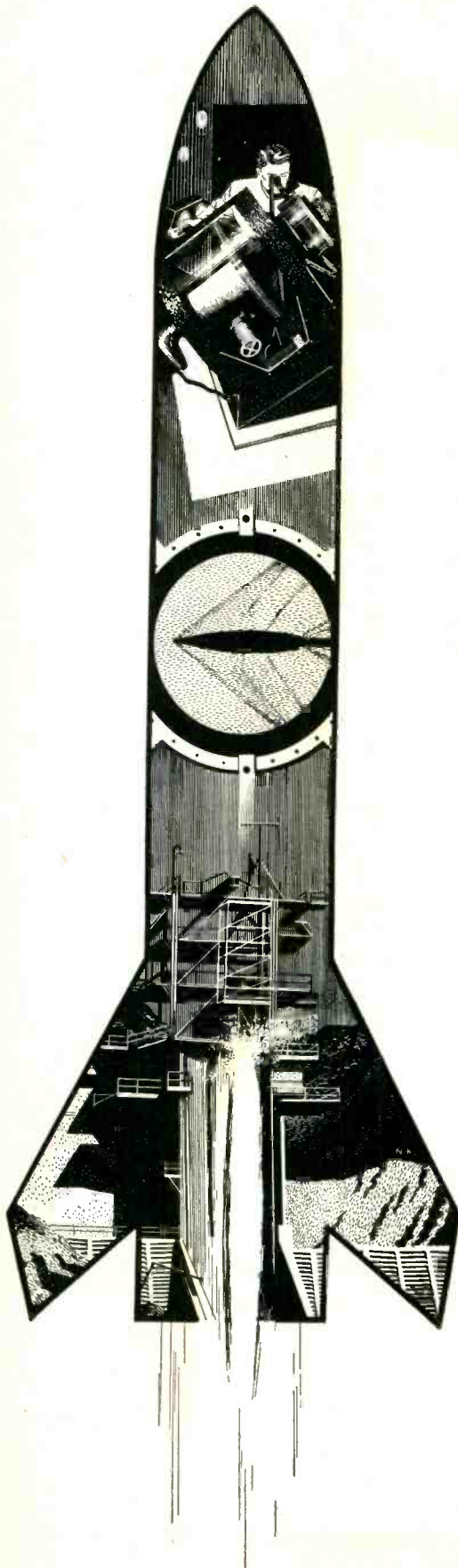

ROME CABLE

C O R P O R A T I O N

TUBE DESIGN NEWS

GENERAL  ELECTRIC

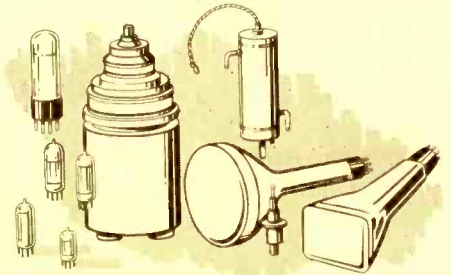

RECEIVING * POWER * CATHODE RAY

Snow-White Cleanliness Extends to 5-Star Tube Parts Manufacture, Inspection, Handling

Broadened facilities for building G-E 5-Star high-reliability tubes under conditions of immaculate cleanliness, include dirt- and lint-free manufacture of the tube sub-assemblies.

All areas of General Electric's 5-Star Tube factory now are air-conditioned and pressurized to keep out dust. Workers, inspectors, and foremen who build and handle parts, wear the same lint-free Nylon and Dacron garments as employees who assemble and test 5-Star Tubes.

Grids are wound and cleaned with virtually no chance that a particle of dust or thread of lint will adhere, to cause tube "shorting". Heaters are formed, coated,

(Continued on Page 2, Column 1)

New G-E Voltage-Tunable Magnetrons in Development Permit Fast Tuning over Wide Range with Steady Output

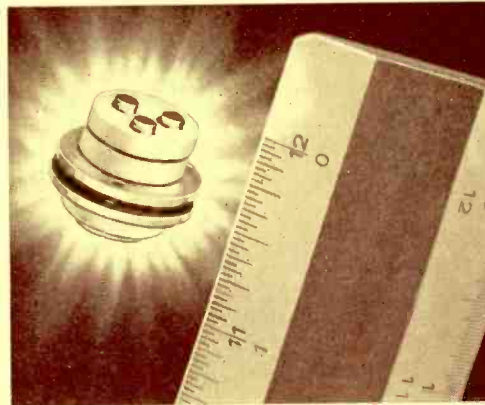

ABOVE, LEFT: the developmental Z-5112 voltage-tunable magnetron is only $\frac{5}{8}$ in. high and $\frac{3}{4}$ in. wide. ABOVE, RIGHT: preliminary tests prove essentially stable power output throughout 2000-mc tuning range.

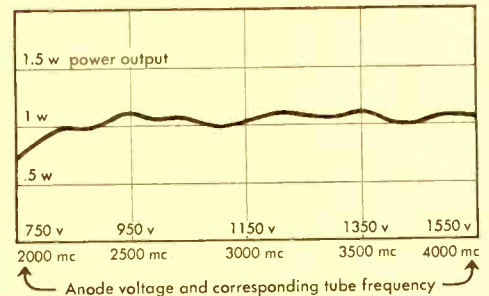

Latest developmental type in a series of voltage-tunable magnetrons pioneered by General Electric, the Z-5112 indicates the advantages which this group of tubes offers to designers of military equipment.

Recent tests of the Z-5112 prove its capability for rapid, efficient tuning over an extended frequency range, from 2000 mc to 4000 mc—with power output .5 w to 1 w throughout.

Counter-measures can benefit from this threefold tube advantage. Also, enemy jamming can be effectively circumvented by rapid tuning over a broad frequency spectrum with little or no reduction in signal power. With tube frequency a linear function of the anode voltage, the Z-5112 and other VTM types can be tuned merely by changing the potential of the anode. This makes for circuit simplicity.

Design benefits of General Electric voltage-tunable magnetrons now in development, are small size, light weight, and metal-ceramic construction. The latter adds strength, and gives high-temperature resistance. Tubes are designed to operate up to 60,000 feet altitude.

Besides being directly useful for counter-measure work, voltage-tunable magnetrons are suited to telemetering—for example, missile tracking; to FM altimeters; to air-navigation applications, broadband test equipment, and microwave communications generally.

Ask any G-E office listed on the next page for information on the development status of voltage-tunable magnetrons.

G-E Snow-White Workers Check Progress on Their 5-Star Tube "Factory", to Operate at March I.R.E. Show

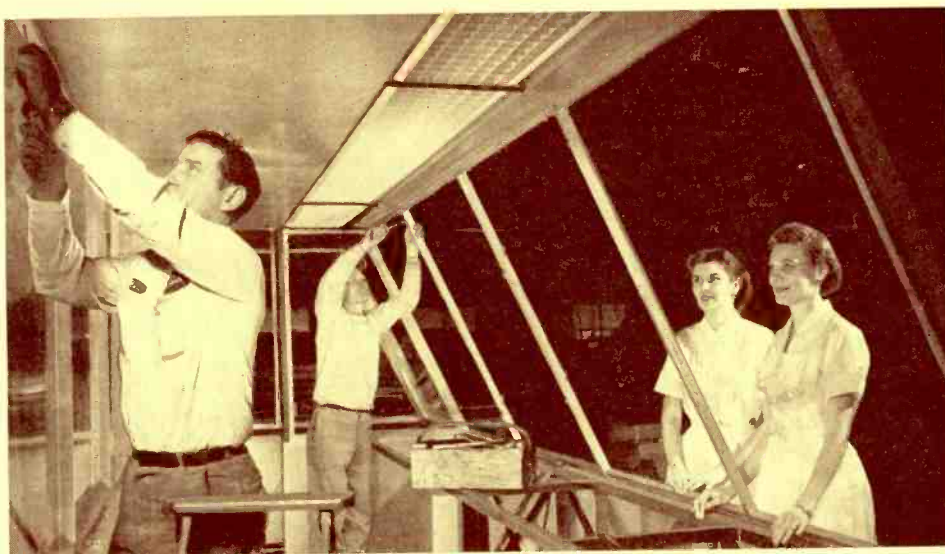

Featured at General Electric's exhibit at the New York I.R.E. Show, will be the actual assembly of 5-Star Tubes in an air-conditioned, pressurized working area, housed in a transparent plastic "factory". Trained operators from General Electric's 5-Star Owensboro, Ky., factory will assemble the tubes . . . Another G-E show highlight: first public demonstration of voltage-tunable magnetrons, described elsewhere on this page.

'Lightning-Rod' Filament Shield for G-E High-Voltage Rectifier Tubes Increases TV Dependability



ABOVE: a special tungsten post shields G-E tube filaments from electrostatic pull of high anode voltages. BELOW: checking 1B3-GT and 1X2-A/B rectifier types during G-E flyback life test that further safeguards tube performance.

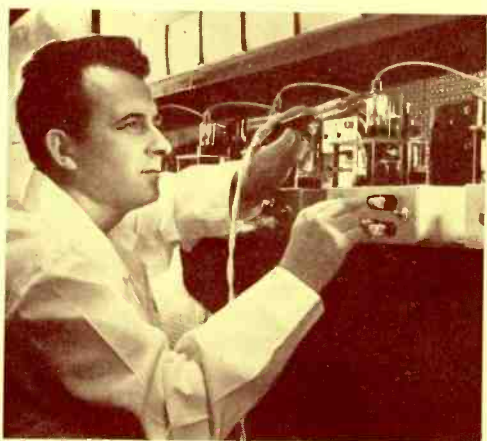

Among numerous steps taken to increase the reliability and long life of General Electric 1B3-GT and 1X2-A/B high-voltage rectifier tubes, mounting a "lightning-rod" shield beside the filament is important. Manufacturers of TV receivers thus are better protected against picture failures in sets in production, on test, and in owners' hands.

G.E.'s tungsten shield, or post wards off electrostatic pull on the tube filament thus minimizing pull-out and filament-to-anode shorts, and sharply reducing the incidence of broken filaments.

In addition, a highly adhesive filament coating further protects against arc-overs. Another special feature: the bulbs of G-E high-voltage rectifier tubes are ringed with conductive material to prevent vertical picture streaking that is caused by bulb charging.

To make sure that tube performance meets design targets, 1B3-GT's and 1X2-A/B's receive a 100% flyback test and a dynamic flyback life test—both at the top ratings for big-screen operation.

Realizing the importance to the TV industry of dependable, long-life rectifier tubes, General Electric is continuously improving its design, production, and test methods for these types.

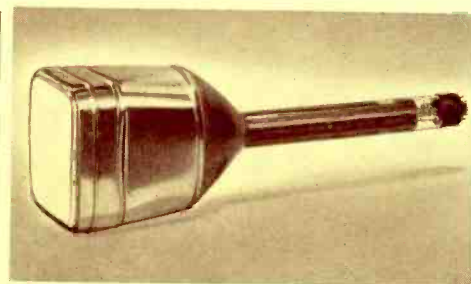

Special bulb design of Z-4399 optimizes resolution, accommodates several types of magnetic deflection yoke for presenting various kinds of information on face plate.

New Z-4399 High-Resolution Tube Accents General Electric's Facilities For Special C-R Tube Development

Used primarily in equipment to pinpoint enemy mortar locations for quick counter-fire, General Electric's Z-4399 C-R tube combines a group of features essential for its purpose—a 5½-in. square face plate that lends itself to a rectilinear coordinate display system; extremely high resolution; magnetic focus and deflection; a bright image brought about by aluminizing.

The tube's neck has been specially lengthened in order to (1) increase image resolution to a new standard of fineness and sharp definition, (2) accommodate several types of deflection yoke.

Designing C-R tubes such as the Z-4399 for specific military or industrial functions, is a job for which General Electric has extensive facilities in research, engineering skill, and equipment. Problems calling for the selection or origination of special C-R types are welcomed.

Snow-White Cleanliness, 5-Star Parts

(Continued from Page 1)

and heat-treated other parts built and processed under the same strict conditions of near-surgical cleanliness.

There are 35 General Electric 5-Star Tubes, 11 of them subminiatures, meeting substantially every military and industrial need. Two new miniature types for computers are included in the line.

RIGHT: 5-Star Tube heaters, after forming and coating, are placed in individual glass cylinders for inspection. This helps guard heaters from contact with dust or lint until the tubes are assembled, exhausted, and sealed off.



EASTERN REGION

General Electric Company, Tube Sales
200 Main Avenue, Clifton, N. J.
Phones: (Clifton) GRegory 3-6387
(N.Y.C.) Wisconsin 7-4065, 6, 7, 8

CENTRAL REGION

General Electric Company, Tube Sales
3800 North Milwaukee Avenue
Chicago 41, Ill.
Phone: SPring 7-1600

WESTERN REGION

General Electric Company, Tube Sales
11840 West Olympic Boulevard
Los Angeles 64, Calif.
Phones: GRanite 9-7765; BRadshaw 2-8566

JUST PRINTED!



New, complete booklet on General Electric 5-Star Tubes—their design, manufacture, and testing. A "must" for designers who require maximum reliability in critical tube sockets. Ask for Booklet ETD-1425!

Progress Is Our Most Important Product

GENERAL ELECTRIC

ELECTRONIC COMPONENTS DIVISION, GENERAL ELECTRIC COMPANY, SCHENECTADY, N. Y.

162-1C3



All shook up over his second Microwave System

His first took 8 months to build — needed lots of engineering and special components. Now he wants a duplicate. Needs it yesterday. Here's the gasser — it's gonna take **another 7 months** to build. Calls for same amount of special construction. Yipes! — what to do?

No problem! Get it built by DeMornay-Bonardi with their standard "building blocks." D-B manufactures 924 types of microwave components, from 2.60 to 90 KMc/SEC — carries 'em in stock. With this wide choice, they can engineer a system in days. Seldom a special component needed, and when there is, only simple alterations do the job. That's why D-B can deliver any complete system in 5 weeks or less. They could have done it on the first one. No problem.

There's more for our engineer — he saves a lot of budget money in the deal. Because D-B isn't stuck

with heavy design work or expensive trial-and-error methods, it sells a system for little more than the cost of components alone. D-B prices run from 25% to 50% less than custom shop prices — for a system guaranteed to work.

To get with it, all our fellow practitioner has to do is send us his electrical requirements and space allowance. We take it from there. New D-B catalog will be sent to company letterhead requests.



DE MORNAY - BONARDI
780 S. Arroyo Parkway, Pasadena, California



... YOU SHOULD KNOW
THERE IS A MORE ACCURATE
V O M



1½% accuracy . . .

mirror scale

to eliminate any possible parallax and give you readings with the same laboratory accuracy that is built into the instrument.

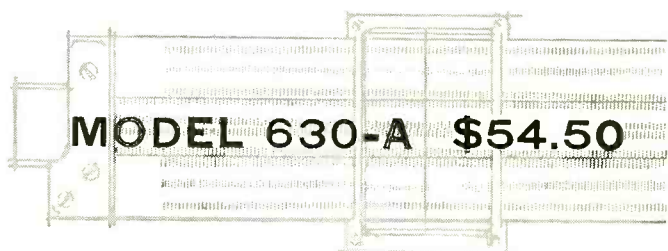

MODEL 630-A \$54.50

This VOM is truly what laboratories buy when they must have the best. Model 630-A is prized in 782 industrial laboratories, 115 research laboratories, 237 development laboratories and is owned by over 300 engineering consultants and used for critical production line testing and in the maintenance of automation equipment by over 1100 manufacturers of all types of products.

TRIPLETT FEATURES:

½% resistors—molded mounting for resistors and shunts allows direct connections without cabling. (No chance for shorts—longer life and easy-to-replace resistors in their marked positions.) King sized recessed knob for the single selector switch for both circuit and range—just turn and make reading.

Resistance ranges are compensated for greatest accuracy over wide battery voltage variation.

33 RANGES:

12 D.C.-A.C. Volts (20,000 ohms per volt DC, 5000 ohms per volt AC.); 5 Current Ranges; Resistance from .1 Ohms to 100 Megohms; Decibel and Output readings.



**TRIPLETT
ELECTRICAL
INSTRUMENT
COMPANY
Bluffton, Ohio**

Burton Browne Advertising

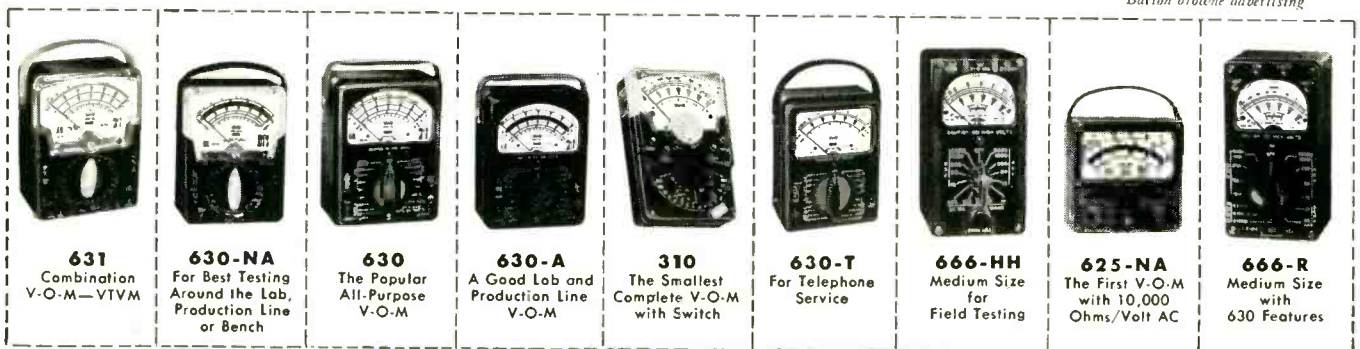

**SPECIFIED INDUSTRY-WIDE FOR
OUTSTANDING DEPENDABILITY...**

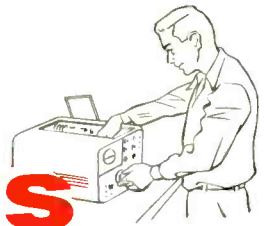

H-H RESISTORS and RHEOSTATS

**Offering Designers and Engineers Electrical and
Mechanical Advantages of Proven Dependability**

**H-H Rheostats are designed for top performance and
long life in military and commercial applications—**



- Smooth, long-life mechanical action
- Permanent, positive electrical contact

Constant pressure contact arm adjusts tension for complete continuous contact, eliminates backlash, prevents birding. High temperature gray vitreous enamel coating increases safety by its ability to withstand overload.

**H-H rugged Gray Line Resistors meet all requirements
for continuous, heavy duty commercial applications —**

- Non-crazing, high temperature coating
- Maximum immunity to humidity, salt spray

Stronger core affords extra dependability under extreme operating conditions. All wire connections on H-H Long Life Resistors feature all welded construction. The fixed, ferrule and adjustable types meet MIL-R-26 specifications.



H-H Blue Ribbon Resistors for Reliability in Applications with Space Limitations



H-H Blue Ribbon Resistors provide higher wattage ratings per unit, save space and weight wherever mounted. Ruggedized construction features high temperature, vitreous enamel, crazeless coating offering maximum moisture resistance. Aluminum thru-bar distributes heat uniformly along entire resistor length. Mounting studs are all corrosion resistant, and bracket assembly is vibration-proof.

Illustrated catalogs available on H-H Resistors and Rheostats include helpful engineering and installation data. Call or write for copies, now! Standard stock items available for immediate delivery from authorized local electronic parts distributors.

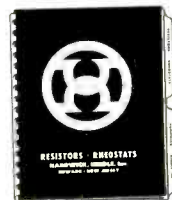

DESIGNED
TO MEET MIL-R-26
SPECIFICATIONS!

See us at the I.R.E.
Show—Booth 3831

**HARDWICK
HINDLE INC**

40 HERMON ST., NEWARK 5, N.J., U.S.A.



*The Mark of Quality
Since 1924.*

FOR MICROWAVE

SPECIFY SPERRY MICROLINE

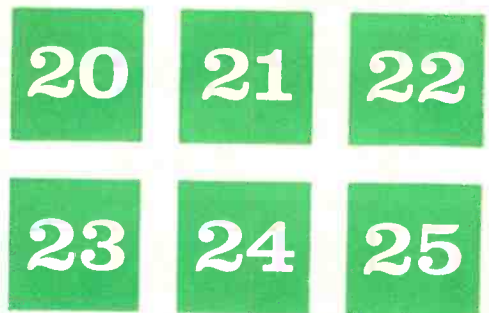
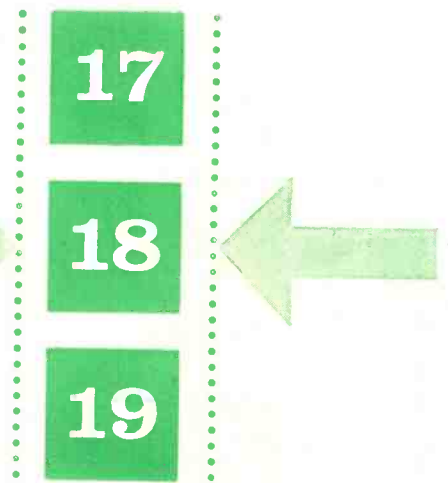
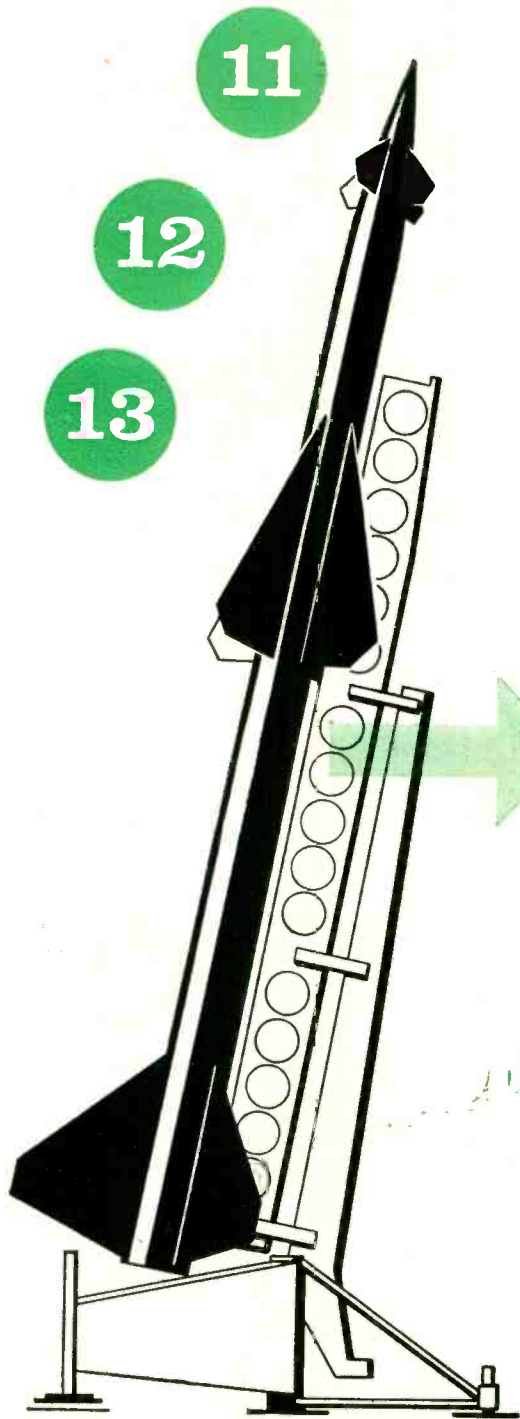

Sperry's Microwave Electronics Division provides a unique service: Developing and producing special radar subsystems and components for the electronic industry. ■ Microline[®] equipment ranges from single miniaturized components to complete microwave systems—together with complex antennas, precision test equipment, and automatic checkout instrumentation ■ Whether your immediate need is for one component or for the complete line, we will be happy to discuss your problem with you. The equipment indicated on these pages together with many other Sperry developments will be on display at the Radio Engineering Show, New York Coliseum, March 18-21, Booths 1416-1422.

SYSTEMS

RADAR

- 1 Antenna
- 2 Multi-feed rotating joint
- 3 Waveguide switch
- 4 Dummy load
- 5 Directional coupler
- 6 Mixer-duplexer
- 7 Local oscillator
- 8 Ferrite isolator
- 9 Transmitter klystrons
- 10 Traveling wave tube drivers

MISSILE

- 11 Antenna
- 12 Receiver
- 13 Transponder

FIELD TEST EQUIPMENT

- 14 Combination test set
- 15 Range calibrator
- 16 VSWR meter

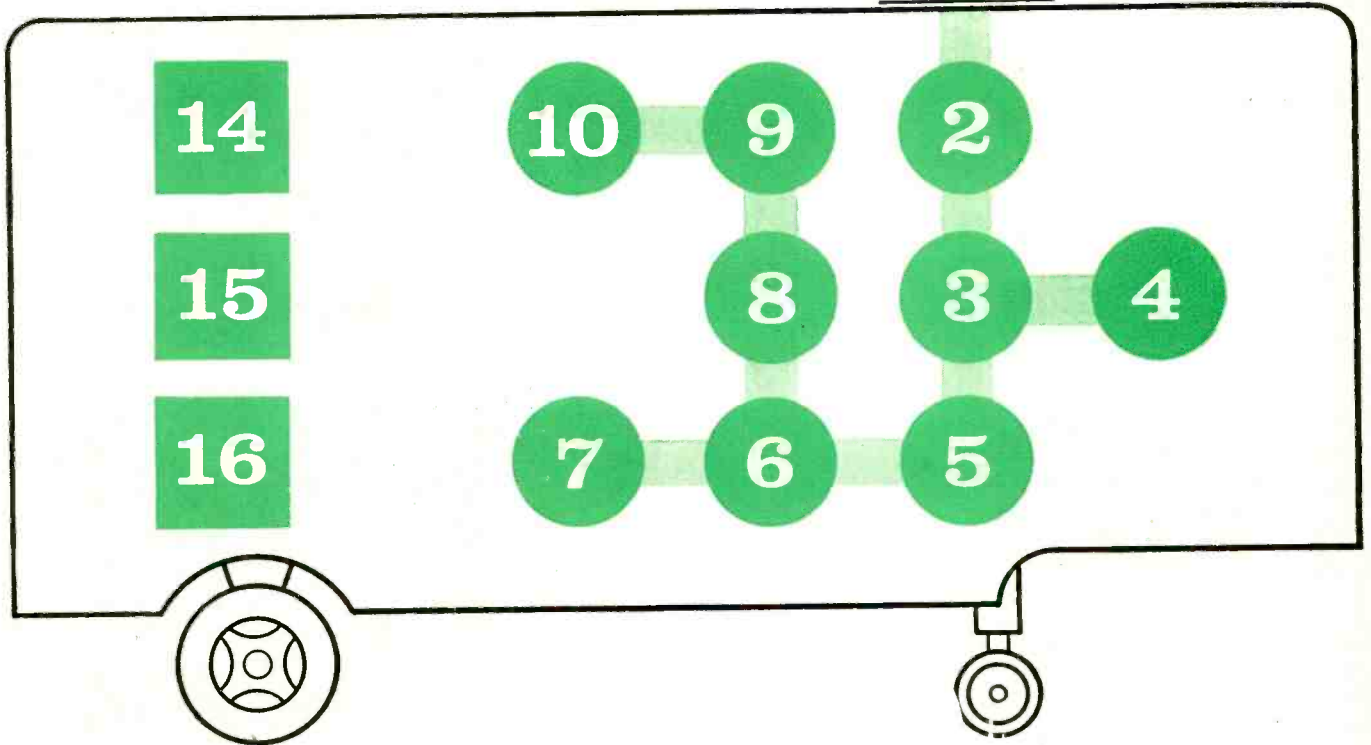
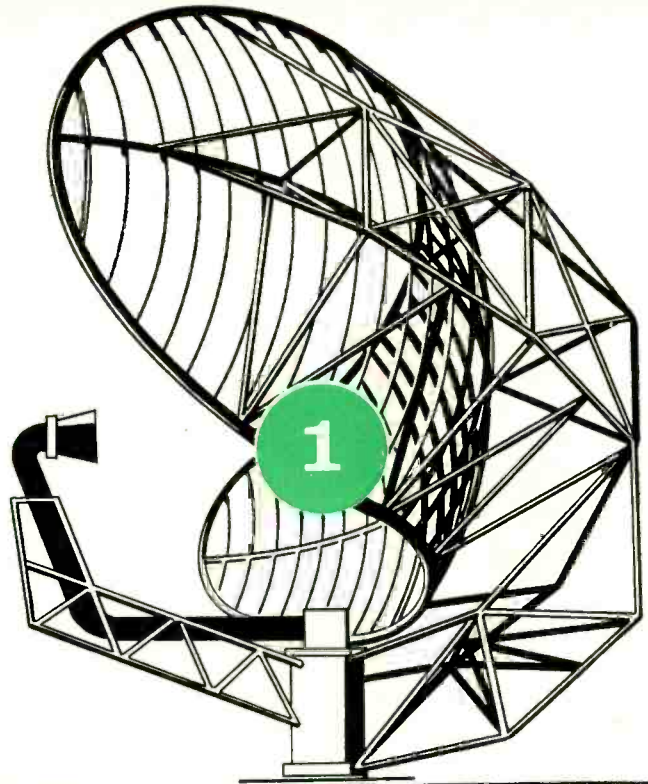

SUPPORT EQUIPMENT

- 17 RACE (Rapid Automatic Checkout Equipment)
- 18 System evaluators
- 19 System performance monitors

DEPOT SUPPORT EQUIPMENT

- 20 Peak power meter
- 21 Multi-pulse generator
- 22 Directional couplers
- 23 Ferrite isolators
- 24 Ferrite attenuators
- 25 Barretter mounts

MICROWAVE ELECTRONICS DIVISION

SPERRY

GYROSCOPE COMPANY

Great Neck, New York

BROOKLYN • CLEVELAND • NEW ORLEANS • LOS ANGELES • SEATTLE • SAN FRANCISCO
 IN CANADA: SPERRY GYROSCOPE COMPANY OF CANADA, LTD., MONTREAL, QUEBEC

HOW TO TEST CORES

You can get your core program off the ground now with the Burroughs BCT-301. This complete and flexible system for accurately measuring the operating characteristics of tape wound cores is the result of six years of core research at Burroughs. And with it, you get the benefit of advanced techniques and procedures which are now in everyday use at Burroughs, and are accepted practice among major core manufacturers.

Designed expressly for the individual testing of square loop cores, the BCT-301 allows precise control over frequency, pattern, amplitude, and rise time of the core driving signal. Thus, you can get extremely accurate measurements of the switching time of the core as well as the amplitude of the output pulse. And the unitized sections of the BCT-301 can be expanded and modified to meet new testing requirements as they arise.

Write for additional details on the BCT-301, or request a demonstration of how this new tool can get your core program off the ground now.

specifications

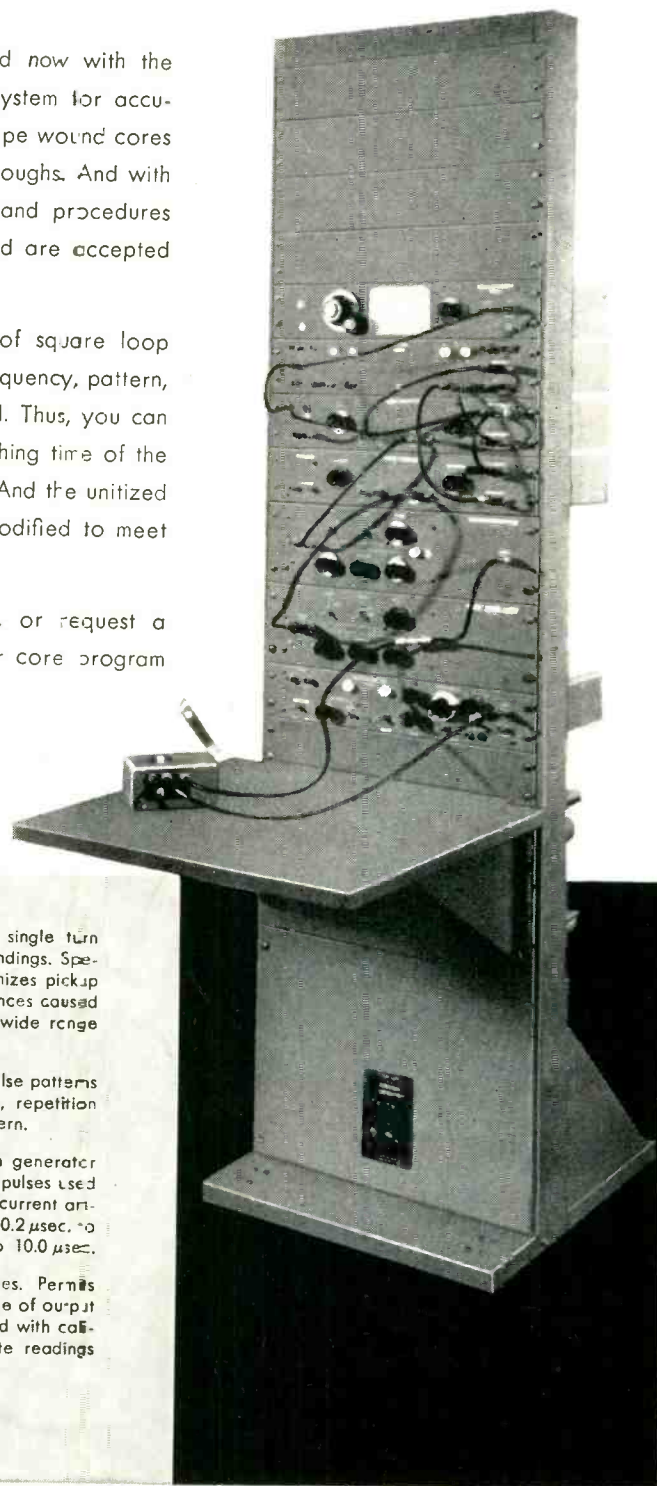

tools for engineers

- | | |
|---------------------------|--|
| core mounting jig: | Low-noise test mounting jig applies tight single turn loops around core for input and output windings. Special electrical and mechanical design minimizes pickup by the secondary as well as other disturbances caused by air flux. Adjustable pins accommodate wide range of bobbin sizes with equal precision. |
| pattern generator: | Provides extreme flexibility in generating pulse patterns applied to core, controlling pulse spacing, repetition rate of cycle, and number of pulses in pattern. |
| current drivers: | Two drivers convert voltages from pattern generator into positive and negative constant current pulses used for driving core. Front panel controls vary current amplitude from 0 to 1.0 ampere; rise time from 0.2 μ sec. to 1.0 μ sec.; pulse duration from 1.0 μ sec. to 10.0 μ sec. |
| calibrator: | Accurately measures currents and voltages. Permits measurement of driving current and amplitude of output voltage with an error of less than 1%. Used with calibrated oscilloscope, permits highly accurate readings of switching time. |
| power supply: | Provides seven regulated d-c voltages. |



Burroughs Corporation • ELECTRONIC INSTRUMENTS DIVISION, DEPT. C, 1209 VINE STREET, PHILADELPHIA 7, PA.
SEE US AT THE I.R.E. SHOW—BOOTHS 1720—1722—1724

TUNG-SOL

Alloy Junction Germanium Transistors

Reliability is the principal characteristic of these hermetically sealed Tung-Sol transistors now in volume production. Gain factor is extremely high over the operating ranges, with excellent heat dissipation. Design and construction methods provide a wider safety margin against the effects of shock, vibration, contamination and temperature. Rigorous testing of electrical and mechanical characteristics assures accurate maintenance performance and life standards. If your equipment designs call for transistors of these or related types, you will find Tung-Sol quality and dependability extremely valuable in maintaining your own output at highest levels.

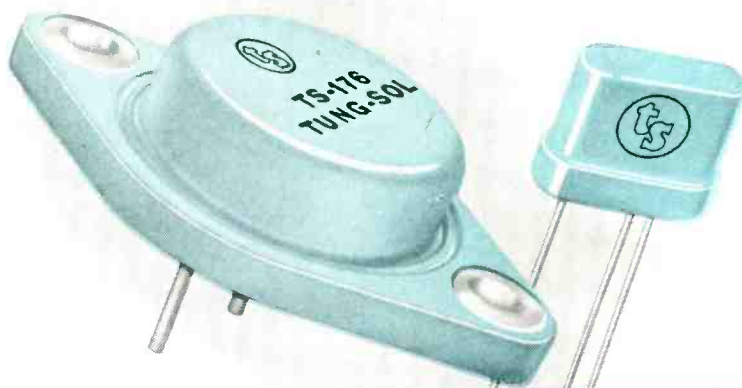

HIGH POWER TRANSISTORS



	RATINGS (25°C)		TYPICAL CHARACTERISTICS (25°C)			
	V _c	P _c	Current Gain 500 MA Ice	Power Gain CL. A	Power Output CL. A	Distortion Max.
TS176	-30 Volts	10 Watts	50db	32 db	2.5 Watts	5%

Type TS176 PNP junction transistor is designed for high power audio service in mobile battery operated equipment. The collector is connected directly to the case for

conduction cooling. Emphasis is given to efficient thermal design, high power sensitivity, low distortion at high current levels and reliable hermetic sealing.

TS612 TS613

These are high power units rated for non-audio applications such as series regulator and power switching. Collector-to-emitter voltage ratings range from 50 to 90 volts depending on circuit conditions.

MEDIUM POWER TRANSISTORS



	RATINGS (25°C)			TYPICAL CLASS B OPERATION (25°C)		
	V _c	P _c	E _{cc}	Power Output	Distortion Max.	Power Gain
TS616	-25 Volts	150 MW	-12 Volts	500 MW	5%	28 db
TS617	-25 Volts	150 MW	-12 Volts	500 MW	5%	31 db
TS618	-25 Volts	150 MW	-12 Volts	500 MW	5%	34 db

PNP alloy junction transistors designed and tested for medium power class B audio applications. Close parameter

control, particularly at high collector currents, makes special matching within type classification unnecessary.

	RATINGS (25°C)			TYPICAL CLASS A OPERATION (25°C)		
	V _c	P _c	E _{cc}	Power Output	R _L	Power Gain
TS619	-25 Volts	75 MW	-12 Volts	2 MW	15,000 OHMS	44 db

PNP alloy junction transistors designed and tested for class A driver service in audio amplifiers. Close parameter

control and hermetic sealing insure production uniformity and performance stability.

More Data? Requests for additional information about these—and other related types of transistors for special applications—should be addressed to: Semiconductor Division, 95 Eighth Avenue, Newark 4, N. J.

Technical Information Service. Upon request, your name will be placed on our special mailing list. You will automatically receive new Tung-Sol semiconductor data and product application notes as such information becomes available.

See You At The IRE Show! The Tung-Sol Booth is 2813-15. It will feature actual assembly of electron tubes and semiconductors.

CAREER OPPORTUNITIES

Tubes and semiconductor products are the foundation of the whole science of electronics. Tung-Sol offers attractive and responsible positions in research, design, development and production. Write to Director of Personnel, 95 Eighth Avenue, Newark 4, N. J.

General Purpose Transistors: The following general purpose RETMA types are also available: 2N63, 2N64, 2N65.

Other semiconductor devices being developed for production include these important types:

Germanium transistors of both PNP and

NPN types, designed for computer switching and radio frequency applications.

Germanium PNP medium power transistor with 350 milliwatt dissipation rating. Gold bonded germanium computer diode.

Silicon power diode with diffused junction.

ELECTRON TUBES • SEMICONDUCTOR PRODUCTS

Tung-Sol Electric Inc., Newark 4, N. J. Sales Offices: Atlanta, Ga.; Columbus, Ohio; Culver City, Calif.; Dallas, Texas; Denver, Colo.; Detroit, Mich.; Irvington, N. J.; Melrose Park, Ill.; Newark, N. J.; Seattle, Wash.

for applications demanding **ABSOLUTE UNIFORMITY**

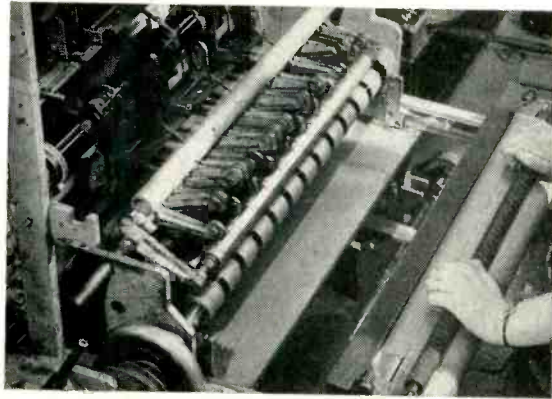

Specify...

ESSEX
EXTRA TEST **MAGNET**
WIRE

Maximum dielectric strength
Dependable insulation qualities
Superior windability

High speed winding subjects magnet wire to a most severe test—demands tough, pliable insulating film . . . spool-to-spool uniformity . . . copper with proper degree of anneal. These are qualities you find in every spool of Essex Extra Test Magnet Wire. Essex engineers maintain close control from raw material through finished product to assure you consistent, trouble-free performance. Essex delivers one quality of Magnet Wire to all customers—"Extra Test"—and this wire is produced to the industry's most severe specifications. You pay no more for these "extra tests" so be sure to specify SX.

TESTING...

Essex Extra Test Magnet Wire has earned its reputation for excellence through continuous testing of every important quality. Here the Dielectric test is being made. Results in each case must exceed accepted standards.



PACKAGING...

Essex Extra Test Magnet Wire is available in Metal or Fiber container (MAGNA-PAK®). Distinctive labeling assures fast, accurate identification. MAGNA-PAK® containers are palatized for shipment; simplifying storage.



EXTRA TEST[®]
ESSEX **MAGNET WIRE**
DIVISION ESSEX WIRE CORPORATION, Fort Wayne 6, Indiana

MANUFACTURING PLANTS — Birmingham, Alabama; Anaheim, California; Fort Wayne, Indiana; Detroit, Michigan.

SALES OFFICES AND WAREHOUSES*

* Birmingham, Ala.
* Chicago, Illinois
Cleveland, Ohio
Dallas, Texas
Dayton, Ohio
Detroit, Michigan
Fort Wayne, Indiana

Fort Worth, Texas
Hartford, Conn.
Indianapolis, Ind.
Kansas City, Mo.
* Los Angeles, Calif.
Milwaukee, Wisc.
* Newark, N. J.

* Portland, Oregon
Rochester, New York
* Saint Louis, Mo.
* San Francisco, Calif.
Upper Darby
(Philadelphia), Pa.

Distributed nationally to the repair and maintenance industry through Insulation and Wires, Incorporated

FILTRON

RF INTERFERENCE FILTERS

RF FIELD ENGINEERING SERVICE

FILTRON

RADAR PULSE PACKAGES

PULSE FORMING NETWORKS

FILTRON

SPECIALTY CAPACITORS

DELAY LINES

COILS

MANUFACTURING and ENGINEERING FACILITIES IN FLUSHING, NEW YORK and CULVER CITY, CALIF.

SALES OFFICES THROUGHOUT THE UNITED STATES, CANADA and for EXPORT

● Visit our Booths 1502-04, First Floor, at the IRE Show in the Coliseum

6 NEW ANSWERS TO TODAY'S

New IRC Dual Diodes

New answer to the bulk, higher cost, and assembly problems of vacuum tube diodes in low current applications.

- featuring balanced miniature selenium cells with low shunt capacitance and high back resistance to 25 volts
- excellent stability and reliability over wide temperature range and environmental conditions
- long life
- economical

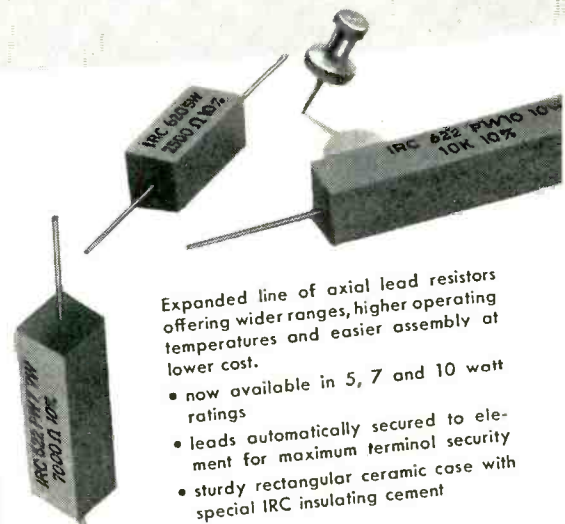
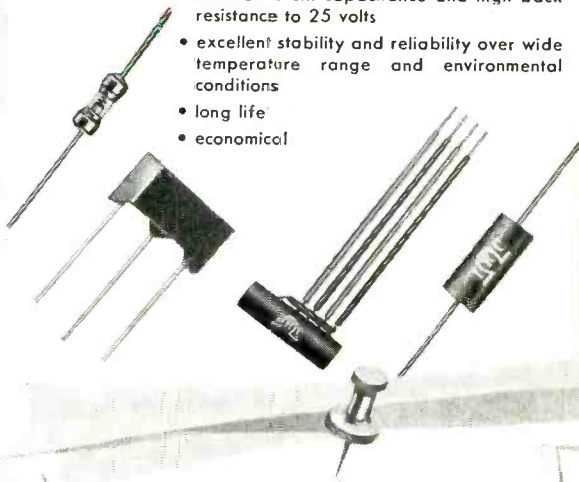

Expanded line of axial lead resistors offering wider ranges, higher operating temperatures and easier assembly at lower cost.

- now available in 5, 7 and 10 watt ratings
- leads automatically secured to element for maximum terminal security
- sturdy rectangular ceramic case with special IRC insulating cement

Power Resistor Line

New IRC Distributed Parameter Delay Lines

A compact, more uniform product for time delays of less than 1.0 microsecond at impedance levels of 4000 ohms or less.

- designed for mass production in a continuous process
- featuring high stability and uniform characteristics
- economical



New IRC Hermetic Sealing Terminals

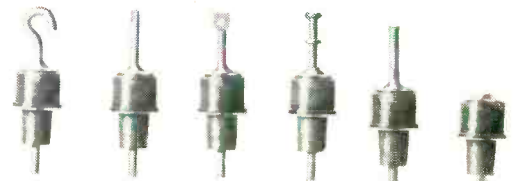

Superior hermetic sealing and insulating performance in miniature units meeting a wide variety of space, electrical, and termination requirements.

- four body designs and six lead types
- excellent resistance to thermal shock, zero water absorption, physically tough, will not crack or craze.
- special fluorocarbon plastic body with superior electrical and mechanical characteristics

DESIGN AND COST PROBLEMS

Deposited Carbon Resistors

New molded resistor line providing a means of obtaining long-term stability up to 100 meg-ohms with savings in cost and bulk.

- 1/8, 1/4, 1/2, 1 and 2 watt ratings
- excellent load life characteristics and resistance to aging
- conservatively rated at 70° C. ambient

Low Range BW Wire Wound Resistors

Now mass produced at low cost for transistor applications where the low value and stability of a wire wound resistor is an important factor. Ruggedized unit to withstand rigors of modern installation techniques.

- fully insulated
- values from 0.24 ohm to 10 ohms

VISIT BOOTHS

2821—2823—2825

Components Floor
RADIO ENGINEERING SHOW
March 18 to 21

Insulated Composition Resistors • Deposited and Boron Carbon Resistors • Power Resistors • Voltmeter Multipliers • Ultra HF and Hi-Voltage Resistors

Wherever the Circuit Says

Low Wattage Wire Wounds • Resistance Strips and Discs • Selenium Rectifiers and Diodes • Hermetic Sealing Terminals • Insulated Chokes • Precision Wire Wounds • Potentiometers



IRC PLANTS—Asheville, N.C. • Boone, N.C.
Burlington, Iowa • Philadelphia, Pa.

Hycor Division, Sylmar, California
Circuit Instruments Inc., St. Petersburg, Fla. (subsidiary)
Hycor Company, Inc., Vega Baja, P.R. (subsidiary)

INTERNATIONAL RESISTANCE COMPANY

Dept. 233, 401 N. Broad St., Philadelphia 8, Pa.

In Canada: International Resistance Co., Ltd., Toronto, Licensee

Send complete information on Selenium Dual Diodes, Delay Lines,
 Hermetic Sealing Terminals, Power Resistors, Molded Deposited Carbon Resistors, BW Wire Wound Resistors

Name _____

Company _____

Address _____

City _____ State _____

The British Electronics Industry is making giant strides with new developments in a variety of fields. Mullard tubes are an important contribution to this progress.

ELECTRONICS IN BRITAIN

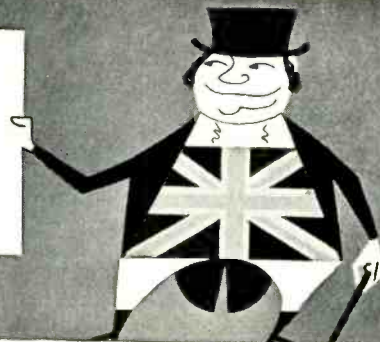

Principal Characteristics

	61SV	61RV
Peak spectral response	2.5 μ	2.5 μ
Spectral range	0.3 to 3.5 μ	0.7 to 4.5 μ
Cell resistance (average)	4M Ω	100K Ω
Max. applied voltage	250V	100V

Sensitivity

a. Tungsten light source at 2700°K	3.0mA/lumen	300 μ A/lumen
b. Black body at 200°C (radiation energy 5.82 μ W; chopper frequency 800c/s; amplifier bandwidth 50c/s)	180V r.m.s./W peak to peak	1.66V r.m.s./W peak to peak

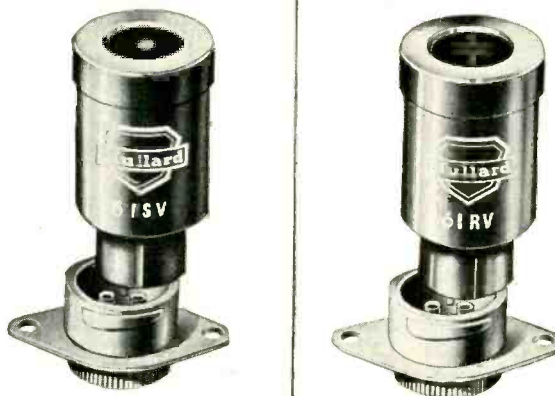

61SV/61RV

extra-sensitive infra-red photoconductive cells

Important among recent British achievements is the introduction by Mullard of two new photoconductive cells, the 61SV and the 61RV. These cells, specially designed for detecting infra-red radiations, combine an unusually high order of sensitivity with an extremely fast response, peaked at a wavelength of 2.5 microns. Their spectral range extends beyond the usual limits of infra-red detectors down to the red end of the visible spectrum.

The high signal-to-noise ratios of the 61SV and the 61RV make them ideal for measuring small temperature variations of relatively low heat sources down to 100°C. Additionally, their small size and rugged construction qualify them for the majority of infra-red applications in industry.

For further technical information and advice on the use of these outstanding photocells please write to either of the companies listed here.

Supplies available from:—

in the U.S.A.

International Electronics Corporation,
Dept. E-3, 81 Spring Street, N.Y. 12,
New York, U.S.A.

in Canada

Rogers Majestic Electronics Limited,
Dept. IC, 11-19 Brentcliffe Road,
Toronto 17, Ontario, Canada.

Mullard

ELECTRONIC TUBES *used throughout the world*

MULLARD OVERSEAS LTD., MULLARD HOUSE, TORRINGTON PLACE, LONDON, ENGLAND

Mullard is the trade mark of Mullard Ltd., and is registered in most of the principal countries of the world.

MEV 44

Want more information? Use post card on last page.

March 1, 1957 — ELECTRONICS



in volume production

backed by 5 years' know-how and over 10,000 units in service

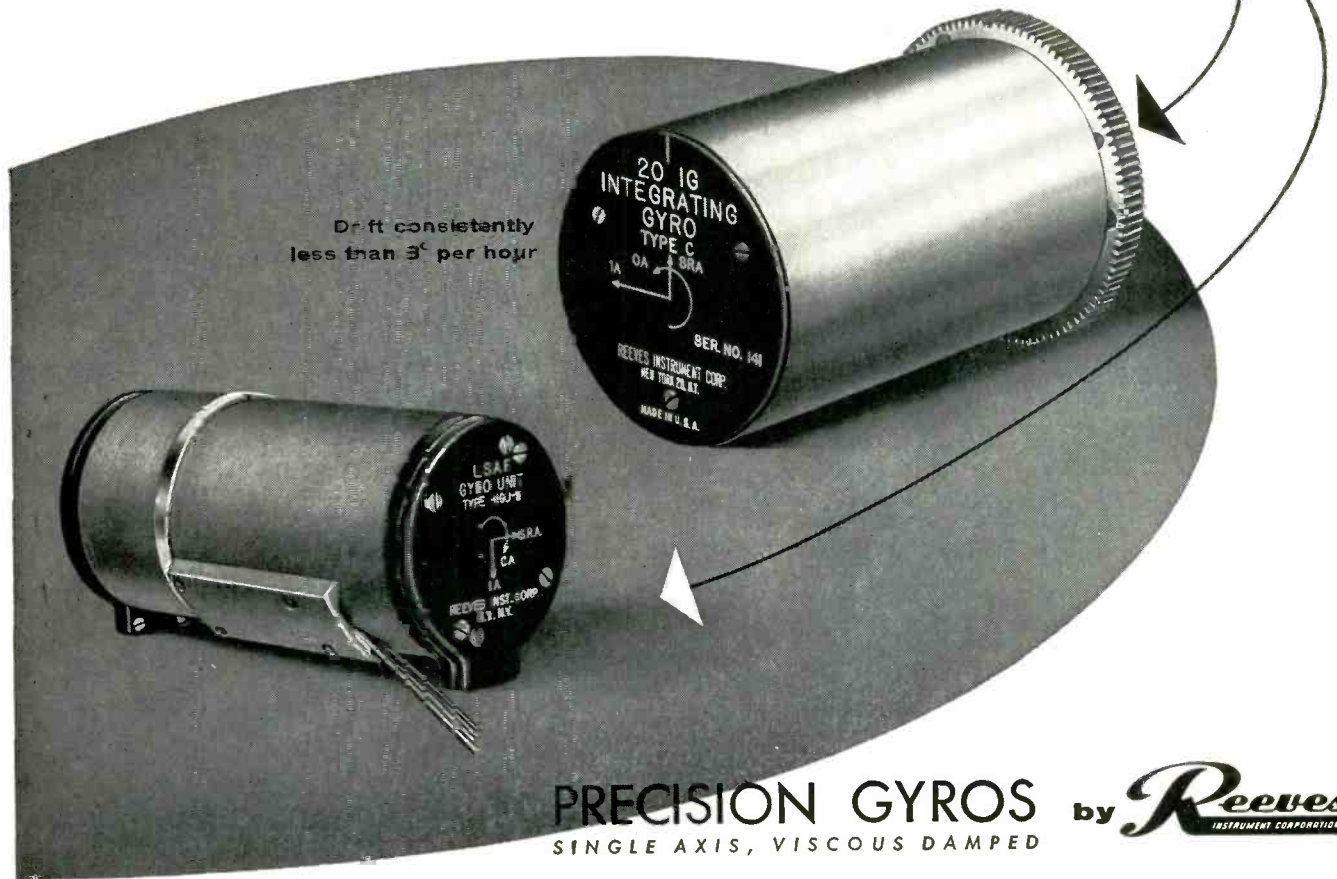

PRECISION GYROS by *Reeves* INSTRUMENT CORPORATION

SINGLE AXIS, VISCOUS DAMPED

See our Booths
1702-1708
I.R.E. SHOW
New York Coliseum
March 18-21, 1957

No manufacturer can show a matching record of precision engineering achievement in this most exacting department... or better our record of PROVED service in the field. Reeves was one of the first to achieve quantity production to high precision standards of the HIG-5 Gyro... the "work-horse" of the gyro field.

Now Reeves has stepped up volume on the new HIG-4 to meet both military and commercial needs... with these exceptional features:

- EXTREMELY LOW DRIFT:** Trimmed drift rate less than 3° per hour.
- FULLY FLOATED:** Will withstand over 100 G's shock.
- MASS UNBALANCE:** Less than 0.5 dyne-cm.
- WIDE RANGE:** Signal generator sensitivity and torque generator sensitivity.
- EXTREMELY COMPACT:** Only 2" dia. x 3" long.

Reeves is now ready to meet your requirements with a full range of single-degree-of-freedom, viscous damped rate and integrating gyros and accelerometers, volume produced to exceptional standards in one of the finest gyro facilities in the world. Outline your needs for our recommendations.



REAC Analog Computers



Precision Floated Gyros



Precision Resolvers and Phase Shifters



Servo Mechanical Parts



REEVES INSTRUMENT CORPORATION
A Subsidiary of Dynamics Corporation of America
201 East 91st Street, New York 28, New York

8RV56

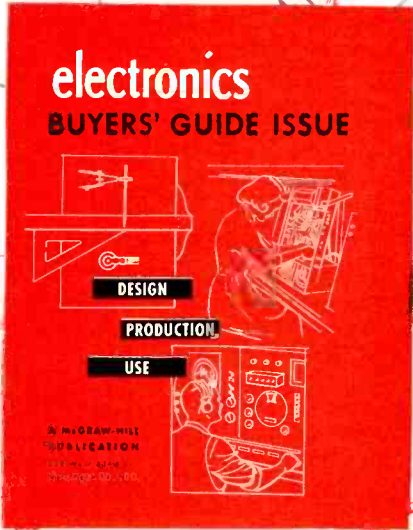
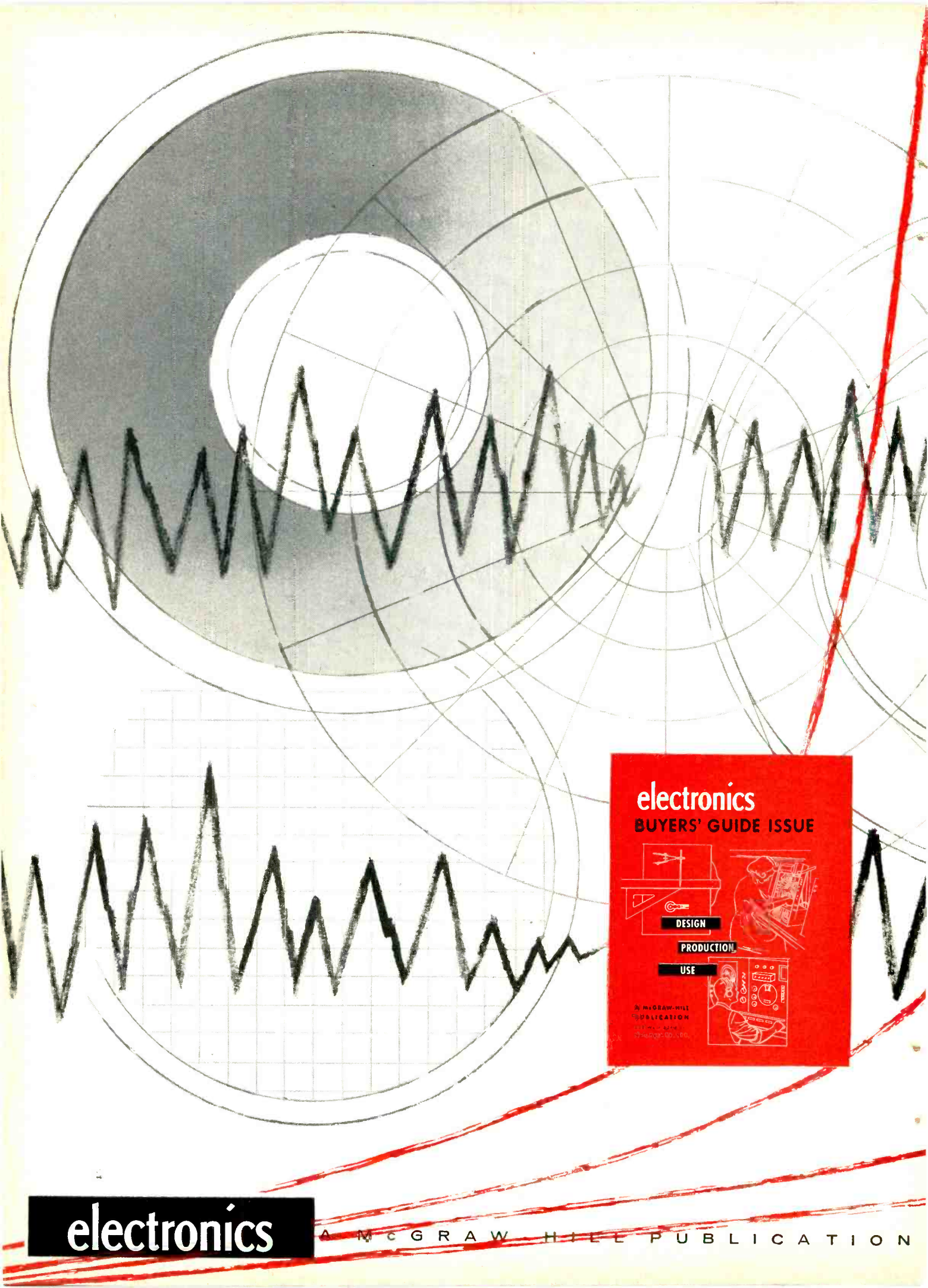

electronics

A MCGRAW HILL PUBLICATION

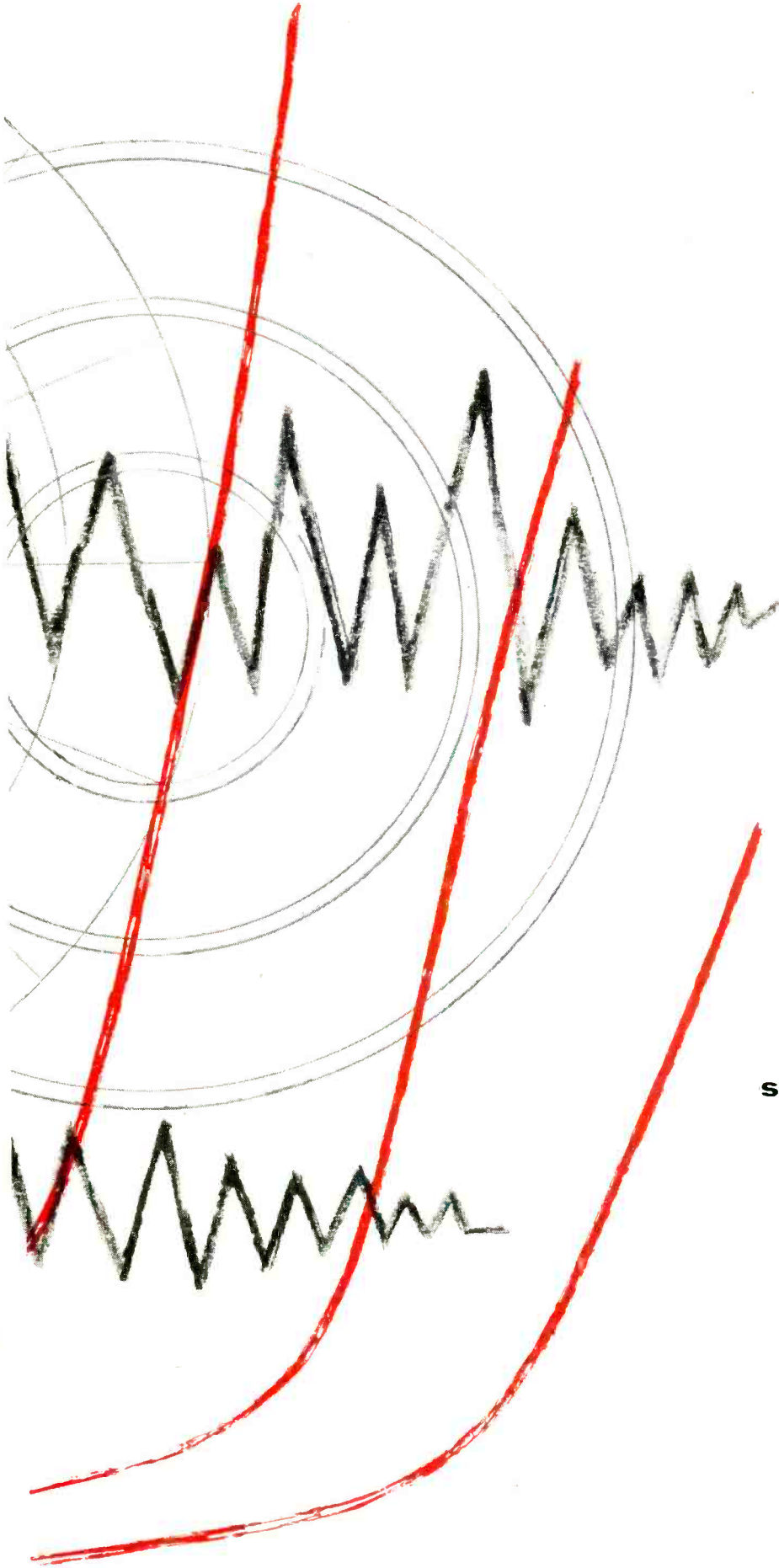

**What
antennas
are to
radio
the 1957
electronics**

BUYERS' GUIDE

**is to
the
electronic
industry**



PUBLISHED MID-YEAR

Closing Dates:

Space reservations . . . April 16

Copy to set . . . April 23

Complete plates . . . May 1

Insert at binders . . . May 31



**Write for:
"Reach the Man
Who Buys
WHEN He Buys"**

3 3 0 W E S T 4 2 N D S T R E E T , N E W Y O R K 3 6 , N . Y .

READY FOR YOU...AT THE I.R.E. SHOW

the pioneer
is the leader

BOOTH **3515-
3517**

3 significant new PANORAMIC instruments

- 1 • Converts Panoramic Spectrum Analyzers to Power Density Analyzers
- 2 • Facilitates Dynamic Balance Analysis
- 3 • Offers new possibilities for miniaturization of FM/FM Telemetry Ground Stations

1 new Model PDA-1 Panoramic's Spectral Power Density Analyzer — A tremendously flexible instrument that expands the utility and versatility of Panoramic's Spectrum Analyzers from Sub-Sonic through Microwave . . . automatically analyzes the energy distribution of random information. Ideal for evaluating noise, vibration and other changing phenomena.

2 new Model SF-1 Panoramic's Synchronous Frequency Analyzer—A versatile, direct reading instrument that has many application possibilities . . . automatically tracks a frequency component derived from a rotating or oscillating source and simultaneously provides a visual plot of component frequency vs. component amplitude. Excellent for dynamic balance analysis.

3 new Model TMC-307 Panoramic's 7-Point Frequency Calibrator—Designed specifically for telemetering applications, the TMC-307 sequentially furnishes seven equally spaced frequencies per channel for all RDB channels within end limits of $\pm 7.5\%$. . . within $\pm 15\%$ for the upper five channels. Other end limits and spacings can be furnished. Channel and frequency point switching may be either manual or automatic. Accuracy is 0.02%. Occupying only 10 1/2" panel space, the Model TMC-307 offers new possibilities for miniaturized ground station equipment.

Pioneers in the field of spectrum analyzers from sub-audio to microwave, unparalleled sweep generator systems and highly reliable frequency calibrators, Panoramic instruments have accelerated completion of research and development projects and helped to clear production test bottlenecks.

Now, Panoramic again leads the way with these three new instruments, highly versatile and far reaching in application.

SEE these significant new instruments . . . get a glimpse of new equipment to come . . . learn how Panoramic's instrumentation for testing, checking or measuring problems can help you . . . in the laboratory, on the production line, or in military applications. You are also cordially invited to witness dynamic demonstrations and to discuss with our engineers technical characteristics and applications of panoramic instruments.

If you cannot attend the show, write, wire or phone for information. A Panoramic Applications Engineer is always available to discuss specific problems.



PANORAMIC
RADIO PRODUCTS, INC.

Panoramic Radio Products, Inc.

10 South Second Avenue, Mount Vernon, New York

Phone: Mount Vernon 4-3970 • Cables: Panoramic, Mount Vernon, New York State

fantastically uniform

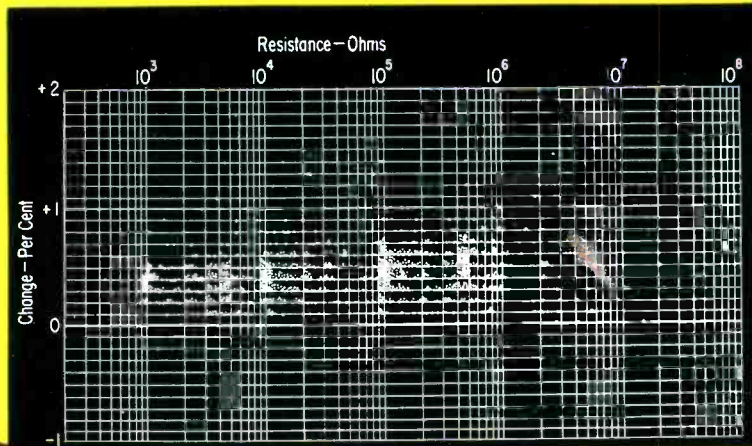

↑ Average percent resistance change after temperature tests (5 cycles from -55°C to 85°C) on samples regularly taken from production of over two billion Allen-Bradley 1/2 watt resistors.

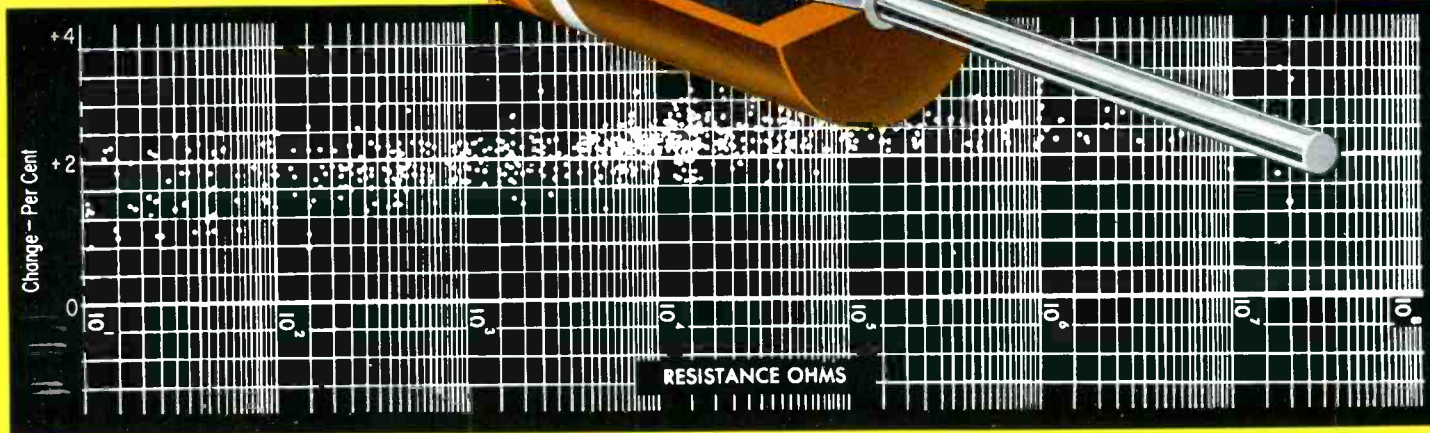

Graph showing the consistency of resistance change in 2 watt resistors in all resistance values from 10 ohms to 100 megohms during humidity test at 95%, 55°C for 113 hours.

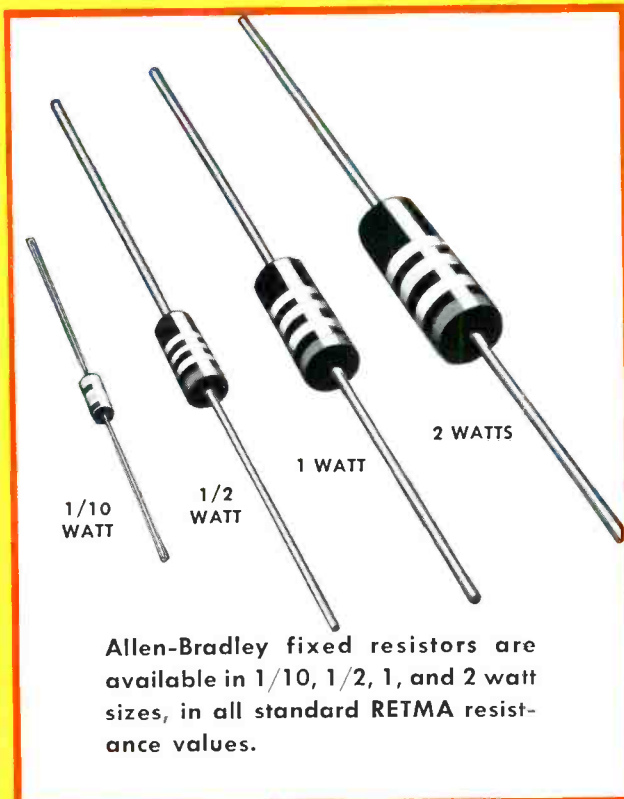

Allen-Bradley fixed resistors are available in 1/10, 1/2, 1, and 2 watt sizes, in all standard RETMA resistance values.

...billion after billion!

To maintain this uniformity, Allen-Bradley quality control engineers take samples of resistors from production continuously and test them. The results of these tests, as shown by the graphs on this page, are amazing. One graph, covering 1248 tests of samples from production totaling over two billion resistors, shows an average resistance change of only 1/2 of 1% after five cycles from -55°C to 85°C! Another graph, plotting production sampling of 100 million resistors in a humidity test at 95%, 55°C for 113 hours, shows only a slight deviation in resistance.

So far as electrical characteristics and mechanical configuration are concerned, Allen-Bradley resistors have no equal. That's why they are so decidedly preferred by electronic engineers throughout the world.

Allen-Bradley Co., 222 W. Greenfield Ave., Milwaukee 4, Wis.
In Canada—Allen-Bradley Canada Limited, Galt, Ont.

ALLEN-BRADLEY
HOT-MOLDED COMPOSITION RESISTORS
QUALITY

an ideal
result...



the A-B hot-molded
composition resistor...
HERMETICALLY SEALED!

● Here's a line of composition resistors that assures you virtually ideal characteristics *plus* complete freedom from catastrophic failures. Because of their ceramic enclosure and high temperature hermetic end seals, these hot-molded composition resistors are unaffected by humidity and moisture. Furthermore, they have an extremely low noise level. All microphonic noise, occasionally encountered in composition resistors due to shock and vibration, has been eliminated. Their unusual rugged construction, and

uniformity of size and configuration make these resistors ideal for mechanical handling.

Special techniques have made it practical to increase the operating temperatures beyond the rating heretofore considered "good practice." The Type ES, 1 watt resistor can be operated safely at 165° C without load; the Type TS at 110° C under the same conditions. Available in tolerances of 2% and 5%; in resistance values from 2.7 ohms up.

Write for Technical Data

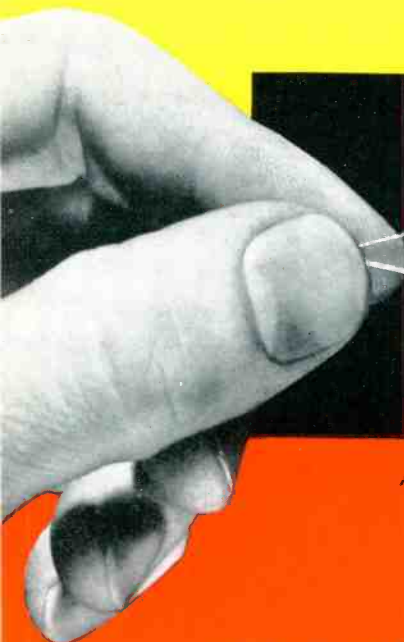

**Allen-Bradley Hermetically
Sealed, Hot-Molded
Composition Resistors, Type TS
(1/8 watt) and Type ES (1 watt)**

Allen-Bradley Co., 222 W. Greenfield Ave., Milwaukee 4, Wis.
In Canada—Allen-Bradley Canada Limited, Galt, Ont.



ALLEN-BRADLEY
RADIO, ELECTRONIC, AND TELEVISION COMPONENTS



SHIPPED FROM STOCK

Oxygen-free high conductivity copper... in convenient rod form

Tube manufacturer ends rejects by using PB&B O.F.H.C. copper rod

A major manufacturer of transmitting tubes was getting rejects of approximately 2 per cent in finished tubes, due to microscopic leaks in a copper part made from extruded rod. Each reject meant loss of a tube worth nearly \$100. This source of high vacuum leakage was impossible to detect before assembly. Since switching to O.F.H.C. hot rolled rod, supplied by PB&B, rejects from this cause have completely vanished.

Need *certified grade* O.F.H.C.[®] copper rod—for use in vacuum tubes or other electrical or electronic equipment?

We can supply you quickly from stock, to highest quality standards. You'll find this material useful and economical in many special applications. It is pre-forged and hot rolled, to produce a dense, homogeneous grain structure free from microscopic porosity. It is not subject to hydrogen embrittlement during hydrogen atmosphere brazing. We certify its conductivity to be at least 98% I.A.C.S.

Cold-straightened rod, in diameters of $\frac{3}{4}$ ", 1", $1\frac{1}{4}$ ", $1\frac{3}{8}$ ", $1\frac{1}{2}$ " and $1\frac{5}{8}$ ", to standard hot rolled tolerances, is regularly stocked in "as rolled" condition. You can order in random lengths, or we can cut to your specifications.

Write today for a quotation on your particular requirements.

® Registered Trade Mark
The American Metal Co. Ltd.

**PHILADELPHIA
BRONZE & BRASS CORP.**

22nd and Master Streets, Philadelphia 21, Pa.

—a subsidiary of

P.R. MALLORY & CO. INC.
MALLORY

How to get reliability

Got the automation jitters?...worried about turning complex manufacturing operations over to an "electronic brain"?...worried about what can happen when one component in the control system fails?...

Reliability takes on a new and different meaning as American industry becomes more and more automated. Here are a few thoughts on the importance of reliability and how it can be controlled.



All of us are going to have to pay more attention to "reliability."

We'll have to pay more attention to individual "devices" within a system.

We'll have to guard ourselves carefully when we design the entire system.

The industrial pendulum is swinging more and more toward automatic controls, servo-mechanisms, computers, and automatic "watchers." As it does, the reliability factor becomes more and more important. Let's see why. For example, you probably have three radios at home. If one fails because a soldered joint comes apart, your home life is probably not disrupted to any alarming degree. But... consider the automatically controlled steel mill. One soldered joint failing, unless all controls are installed in duplicate (which is expensive) could tie up the entire production process for valuable minutes, if the maintenance crew has second sight. For hours, if automatic trouble-indicating and locating systems are not installed (and these are expensive, too). Last, but not least, lend a thought to the dependence of guided missiles and man-made satellites upon the reliability of electronic circuits and components. So... let's start to examine "reliability." Let's begin by looking at this definition which is currently popular in the technical field:

The reliability of a particular component or system of components is the probability that it will do what it is supposed to do under operating conditions for a specified operating time.

Now... this is a relatively well-accepted definition, and it offers the key to the problem of coping with failure control. Take the word "probability" in this definition. Let's discuss its implication.

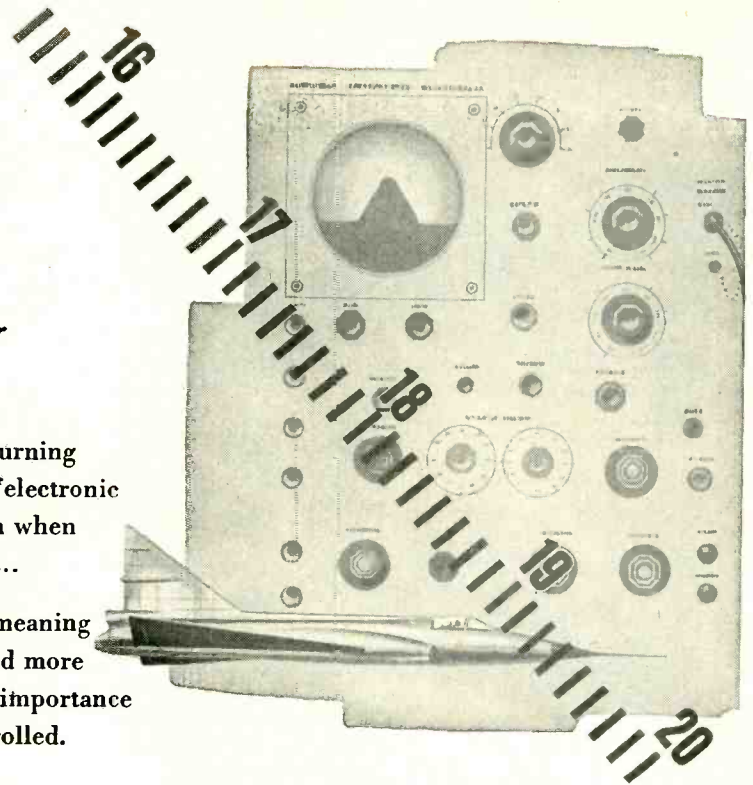

Many of today's systems, simple or complex, are a chain of components. So picture a system as a chain with its successive links. In the field of statistics the over-all reliability of the chain is the mathematical product of the reliabilities of the individual links...

$$\text{Overall Reliability, } R_0 = r_1 \times r_2 \times r_3 \dots r_n$$

Now, let's consider a system made up of 100 different components, each of which has a reliability of 99%. In applying the formula, multiplication of .99 by itself 100 times gives an over-all reliability for the system of only 36.5%. Two out of three systems you have put together will probably fail!

Cannon becomes involved with this problem because our main business is making electric connectors. So, let's look at the following chart that covers contact reliabilities and reliability of the assembly in which they are mounted.

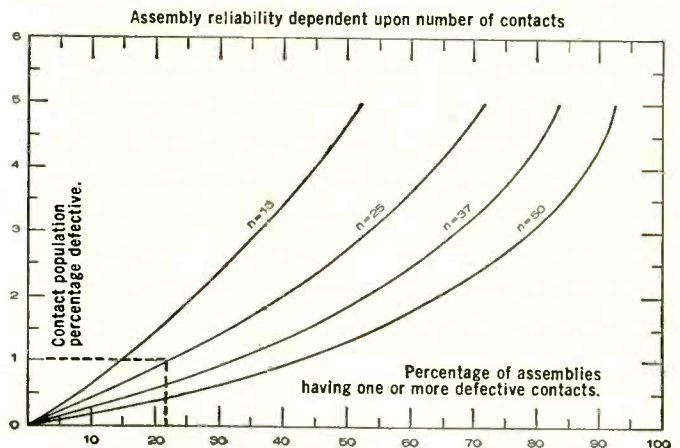

This chart illustrates the reliability of four connectors having 15, 25, 37 and 50 contacts respectively. As an example, assume that the contacts have a contact population of 1% defective (1 in 100 defective... this percentage is considered a fairly high standard in most fields). On the 15-contact assembly, we find from our chart that 14% of the connector assemblies would have one or more defective contacts! With 25 contacts, 22% would have one or more defective contacts. With 50 contacts, 41½%... is your hair starting to curl? Obviously, a 99% contact reliability standard for guided missile components is absolutely unacceptable. And, in between the simplest system and that of a guided missile, are hundreds of assemblies and systems whose reliability factors must be analyzed with utmost care.

But all is not lost! There's another side to the picture. With proper care, analysis, and control, our Cannon organization has actually achieved, in special "missile quality" contacts, a known level of only $2.85 \times 10^{-3}\%$ defective... only 1 part in 35,000! Naturally, we don't achieve that with all our contacts... but we do try to design and manufacture the utmost in reliability required for specific applications.

We have pictured this chart to show the direction we must all take, whether we're talking about connectors, other components, or systems. It boils down to two steps...

- * The number (n) of components must be kept low... *simplicity.*
- * The level of component reliability must constantly be improved... *hard work for all of us.*

Now... if we refer to our reliability definition on the previous page we note the phrase "do what it is supposed to do." So be sure *you* define these objectives for your component assembly, or system... failure to do so carefully can cause undue failure or the expenditure of unnecessary dollars for needless, excessively-reliable parts or design.

Further on in the same definition, we note the words "operating conditions." This brings up many new points for consideration. Here we are concerned with such things as temperature, pressure, humidity, corrosive atmosphere, stray electric and magnetic fields, low and high frequency noise, shock and vibration. Do your design standards need upgrading? Are your components designed and then tested to meet the operating conditions you specify... or are they designed to meet "average" conditions? Are you using adequate "safety factors"?

In a simple component, manufacturers have always looked for, recognized, and corrected faults when they occurred. We use component quality control to achieve and maintain Cannon's world famous product quality. But in complex systems such component quality control is not enough. Actually...

Reliability control over the system is needed. It should be all-encompassing. When you get right down to it, reliability is the product of procedures, equipment, and people... in



the design, manufacture, testing, control of quality, transportation, and use of products or systems.

Do you have a reliability control system?

Here are a few of the steps that are needed to get a reliability control system operating:

- 1. Determine Your Requirements.** Specify the environment, operating time, performance limits, and the percent of reliability required. Allow an adequate safety factor keeping in mind the end use of the finished product.
- 2. Collect Reliability Data.** Set up facilities for the continuous accumulation of data on component or system failures and their causes.
- 3. Establish quality control** and test procedures which show high degree of correlation with end-use conditions.
- 4. Analyze.** Determine if reliability requirements are being met. Establish the most important causes of failure by analyzing the data you collect.
- 5. Improve.** Take action to eliminate the most important defects or causes of failure. Reduce the failure rate to the required level.
- 6. Maintain Continuous Vigilance.** You have emphasized system design... you have used statistical analysis of failures... now exert continuous and critical control to be sure your "improvements" actually improve reliability. Examine new and unforeseen failure sources. Review and modify your requirements with changing conditions.

*

We at Cannon Electric are proud of our historical emphasis on quality and reliability. Since 1915 we have adhered to a design philosophy embracing the highest quality and reliability in each and every Cannon Plug for the specific application for which it is to be used. *If we can't design to that principle, we don't make it!* In manufacture, we are proud of our know-how in depth, proud of our fine quality control systems, proud of our personnel and proud of our reliability control group.

Whenever you have an electric connector reliability problem... in design, engineering, production, or prototype phases... we would appreciate the opportunity of discussing it with you.

Cordially,

Robert Cannon President

CANNON ELECTRIC COMPANY
3208 Humboldt St., Los Angeles 31, California



CANNON PLUGS

Eight plants around the seven seas!

Please Refer to Dept. 120

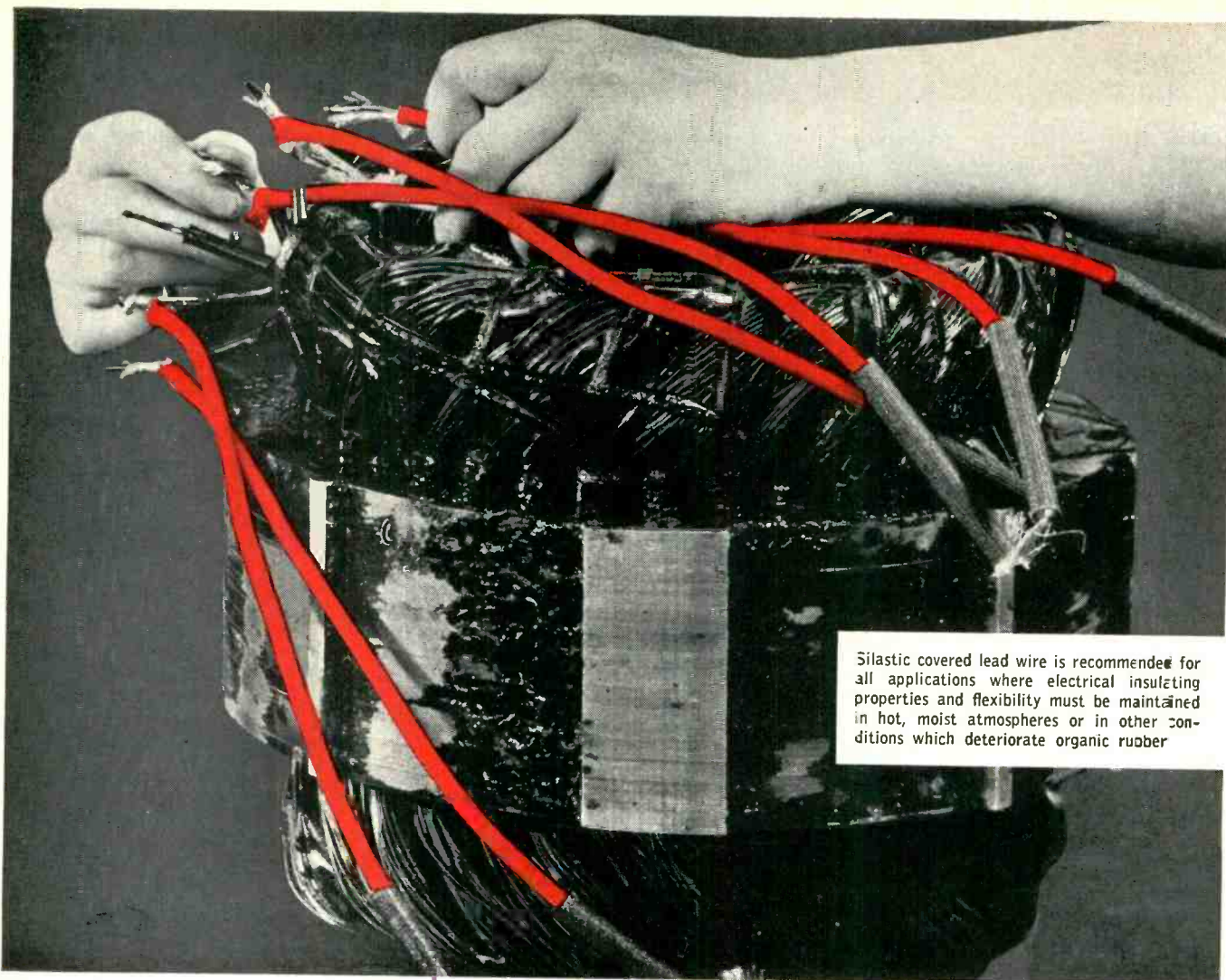

Silastic covered lead wire is recommended for all applications where electrical insulating properties and flexibility must be maintained in hot, moist atmospheres or in other conditions which deteriorate organic rubber

SILASTIC covered cable stays flexible at 500 F

SILICONE RUBBER

Get latest data on Silastic
Mail coupon today

Dow Corning Corporation, Dept. 4815
Midland, Michigan
Please send me latest data on Silastic

NAME _____
COMPANY _____
ADDRESS _____
CITY _____ ZONE _____ STATE _____

Even after repeated exposure to temperatures as low as -130 F or as high as 500 F Silastic[®], Dow Corning's silicone rubber, retains its flexibility, dielectric strength and resistance to ozone, weathering, moisture, certain hot oils and corrosive atmospheres. That's why Silastic, employed as a covering for all types of electric wire and cable, assures the ultimate in reliable service. Ask any leading rubber fabricator.

Typical Properties of Silastic for Wire and Cables

- Temperature range, °F -130 to 500
- Tensile strength, psi 600 to 900
- Elongation, % 150 to 300
- Insulation Resistance, megohms/1000 ft. 1000 to 3000
- Dielectric strength, volts/mil 300 to 500
- Dielectric Constant, 10² cycles per second, nominal 3.2

If you consider ALL the properties of a silicone rubber, you'll specify SILASTIC.

first in silicones

**DOW CORNING
SILICONES**

DOW CORNING CORPORATION • MIDLAND, MICHIGAN

Another **NEW** Plug-In Unit to *increase* the value of your Tektronix Type 541 and Type 545 Oscilloscopes

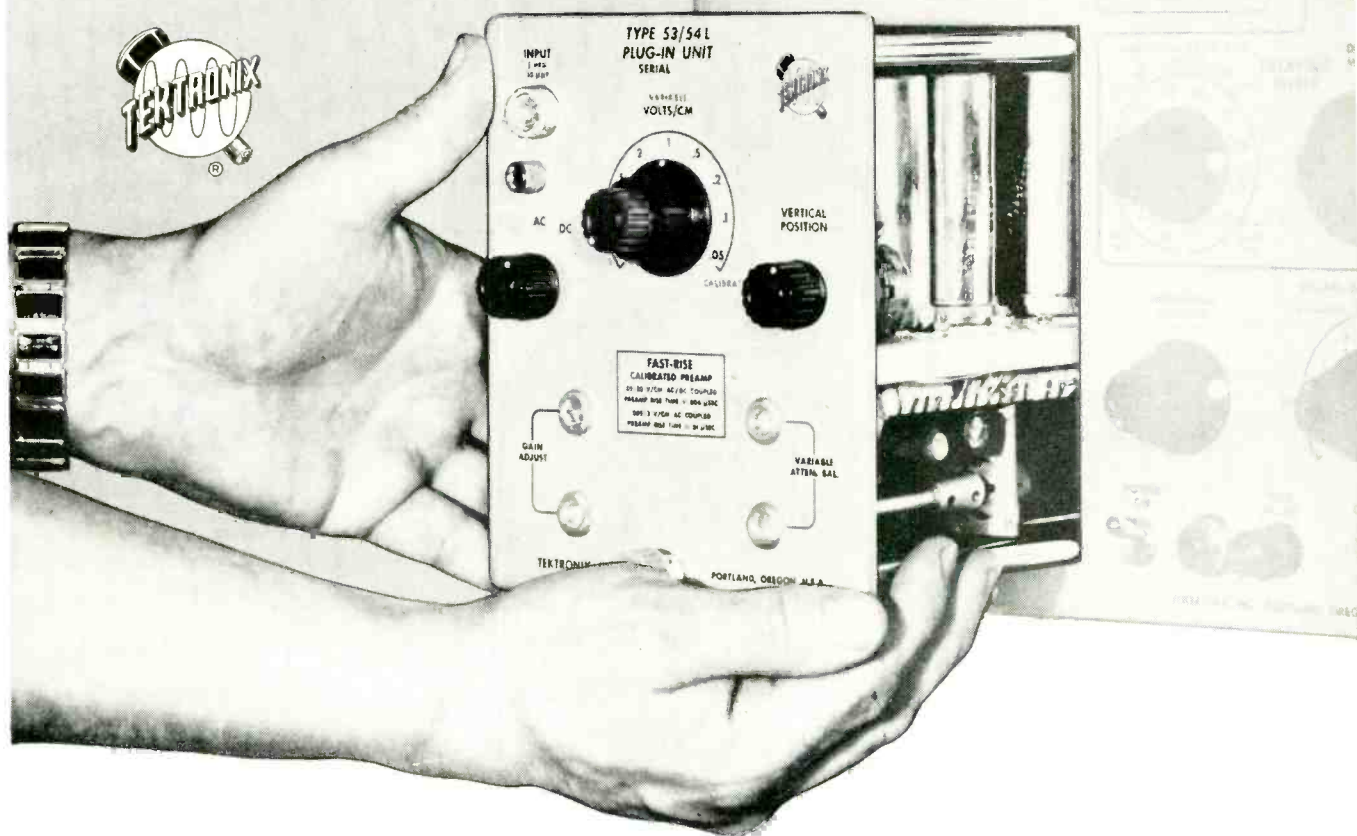

High Sensitivity for Fast-Rise Applications—The new Type 53/54L Fast-Rise High-Gain Pre-amplifier plugs into your Type 541 and Type 545 Oscilloscopes, increasing the calibrated vertical deflection factor to 5 millivolts/cm. At the higher deflection factors (5 millivolts/cm to 50 millivolts/cm), risetime is 0.015 μ sec and vertical passband is 3 cycles to 24 mc. From 50 millivolts/cm to 50 volts/cm characteristics are the same as the Type 53/54K Unit... risetime 0.012 μ sec, passband dc to 30 mc. Input capacitance is 20 μ mf direct, 8 μ mf with the 10x attenuator probe furnished with Type 541 and Type 545 Oscilloscopes. Other probes with higher attenuation ratios are available to reduce input capacitance to as little as 2.5 μ mf.

Type 53/54L Fast-Rise High-Gain Unit \$185

First shipments are expected to be made during July, 1957. Please keep in touch with your Tektronix Field Engineer or Representative for current details.

SEE THE TYPE 53/54L UNIT AND OTHER NEW TEKTRONIX INSTRUMENTS AT THE IRE SHOW, BOOTHS 3028, 3029 AND 3030.

OTHER PLUG-IN UNITS FOR TYPE 530-SERIES and TYPE 540-SERIES OSCILLOSCOPES

Type 53/54A—Wide-Band DC Unit	\$ 85
Type 53/54B—Wide-Band High-Gain Unit	125
Type 53/54C—Fast-Rise Dual-Trace DC Unit	275
Type 53/54D—Differential High-Gain DC Unit	145
Type 53/54E—Low-Level Differential AC Unit	165
Type 53/54G—Differential Wide-Band DC Unit	175
Type 53/54K—Fast-Rise DC Unit	125

Prices f.o.b. Portland, Oregon

Tektronix, Inc.

P. O. Box 831 • Portland 7, Oregon
Phone CYPRESS 2-2611 • TWX-PD 265 • Cable: TEKTRONIX

NOW...

a completely new subminiature paper tubular capacitor

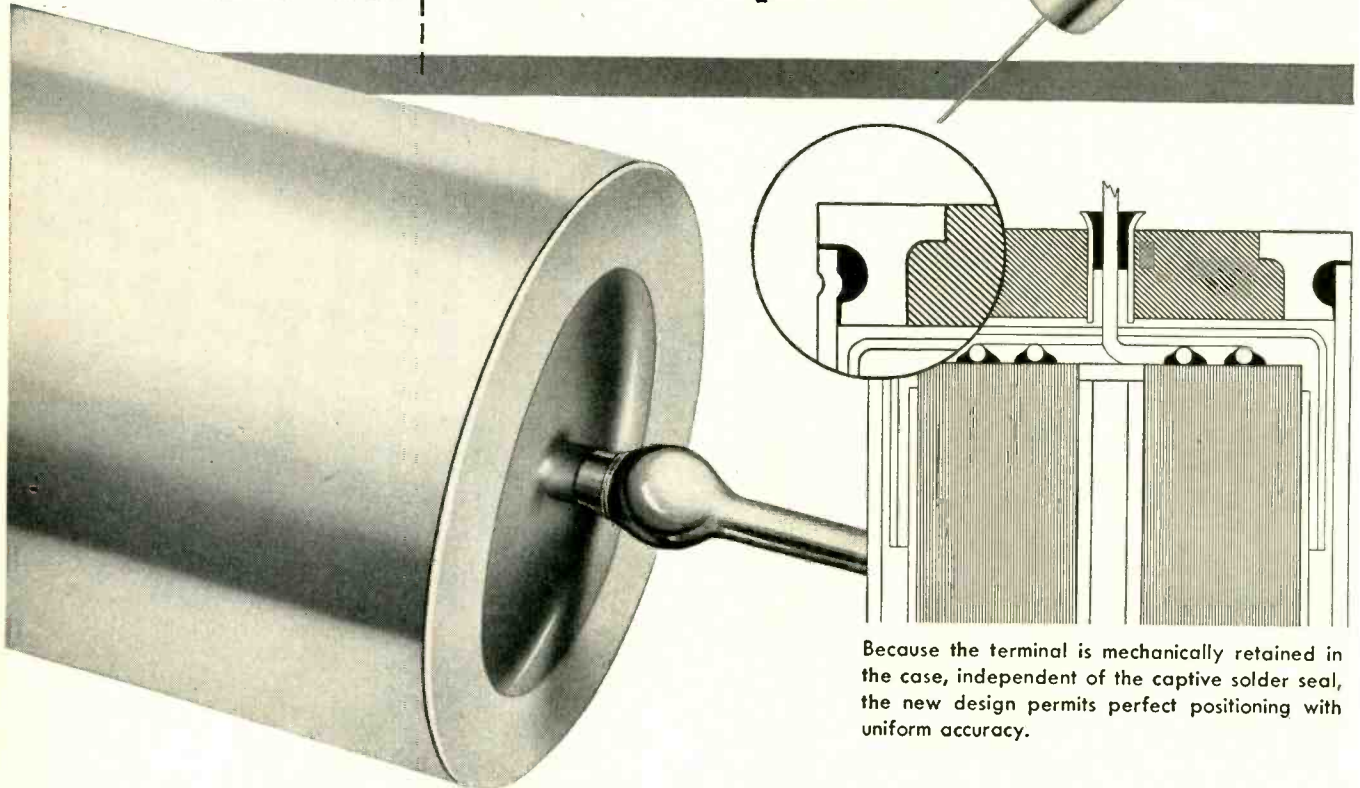

Because the terminal is mechanically retained in the case, independent of the captive solder seal, the new design permits perfect positioning with uniform accuracy.

Hermetically sealed with Sangamo's new "Innerseal" terminal...for higher reliability...for longer service life

Here is today's latest development in miniaturized military type capacitors—a newly designed terminal for Sangamo subminiatures. This Sangamo engineering development offers many advantages over conventional seals.

The "Innerseal" structure seats and locates itself exactly on the case. Terminals cannot be cocked at angle, extend out of case, or be pushed too deeply into case and cause cupped

ends or section damage. It permits optimum performance and reliability through greater flexibility of internal design.

The solder is confined and automatically sealed. Solder or flux cannot run down inside case to cause life failures due to contamination. There are no cracked terminals due to solder time variation.

Write for full information—ask for Engineering Bulletin TSC-117, or

**SEE THIS NEW CAPACITOR AT THE I. R. E. SHOW
VISIT SANGAMO BOOTH 1213**

SC57-3

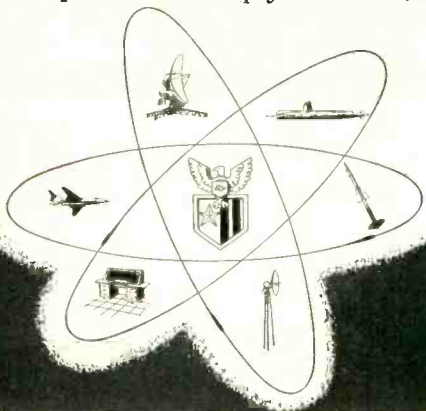

SANGAMO ELECTRIC COMPANY
Electronic Components Division
SPRINGFIELD, ILLINOIS

MIL-AC Custom Air Conditioning

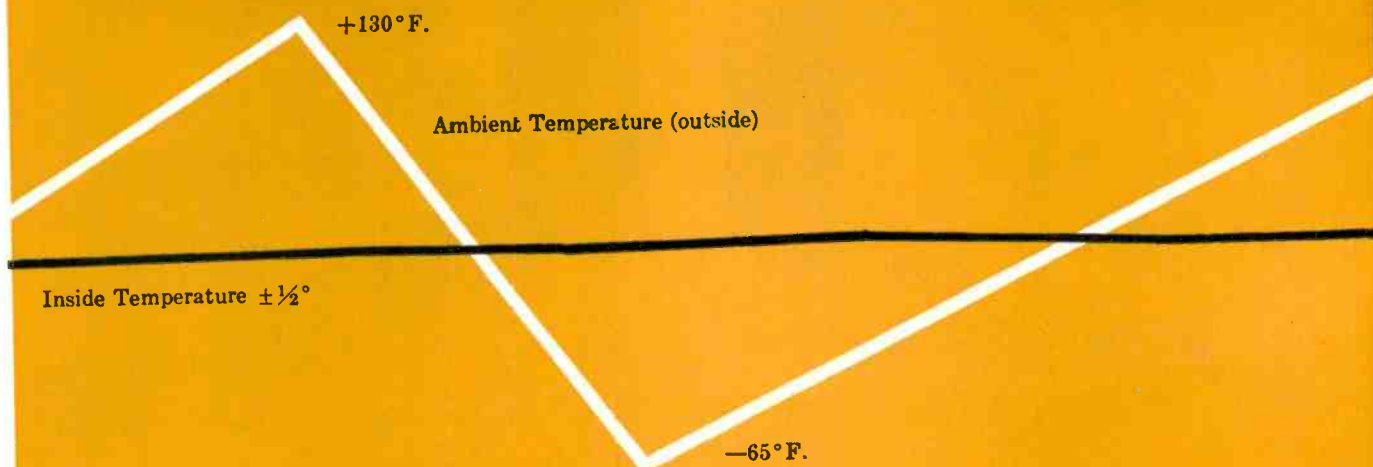

Condition: MIL-E-5272* Today, electronic systems can function under the most difficult environmental conditions (MIL-E-5272*), by using highly specialized air conditioning equipment.

Custom air conditioning is our business at Ellis and Watts. For example, we recently designed and built MIL-AC Units for Radome installations operating in ambient temperatures from -65°F. to $+130^\circ\text{F.}$ These air conditioning units maintain temperatures within $\pm \frac{1}{2}^\circ\text{F.}$, with continuous dehumidification under varying internal load conditions. Because of antenna sweep height of unit was restricted to 36".

MIL-AC Units are self-contained, compact, lightweight, readily air-transportable. They can be designed to cool, heat, humidify, dehumidify, filter, and can incorporate air-cooled or water-cooled condensers. Units are manually or automatically controlled. We are staffed with specialists who will analyze your requirements, submit a proposal, complete your installation promptly and to your complete satisfaction.

Write for helpful load calculating Nomograph and other technical data for use in making time-saving preliminary calculations.

*Military specification dealing with the following climatic and environmental conditions: Temperature, humidity, altitude, salt spray, vibration, fungus, sunshine, rain, sand and dust, explosive atmosphere, acceleration and shock.



Typical MIL-AC Unit. MIL-AC configurations, features and functions to suit your specific requirements.

ELLIS AND WATTS PRODUCTS, INC.



P.O. Box 33, Cincinnati 36, Ohio.

Ellis and Watts also design and build custom air conditioners, liquid coolers and heaters, dehumidifiers, wave guide dehumidifiers, laboratory temperature and humidity control units.

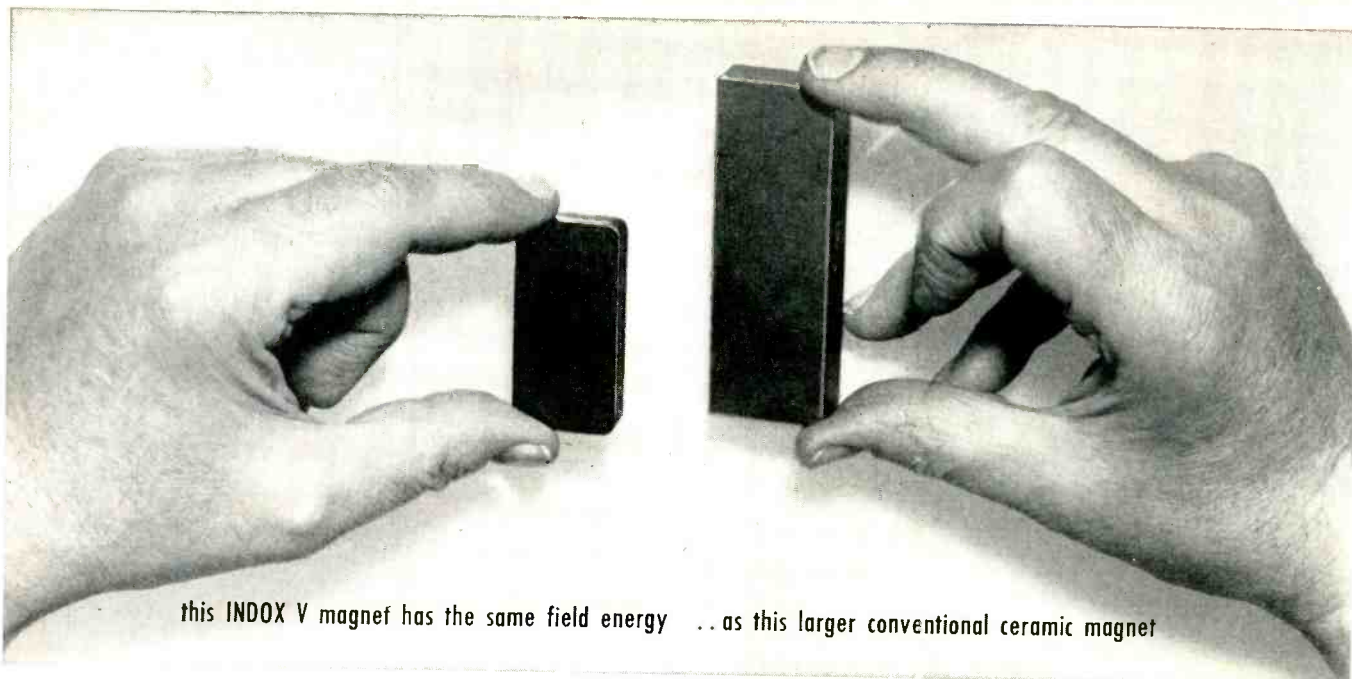

this INDOX V magnet has the same field energy . . . as this larger conventional ceramic magnet

NEW, high energy Indox V ceramic permanent magnets

.. they're 3½ times stronger than conventional ceramic magnets

Indox V — another first from the research and development laboratories of The Indiana Steel Products Company — is available to magnet users *immediately*. This unique, new, magnetic material offers these important advantages . . .

Indox V requires no critical materials. It is a highly oriented barium ferrite . . . using inexpensive, noncritical, raw materials that are constantly available. Shortages in times of emergency cannot occur.

Indox V requires less space, weight to do same job. Volume and weight comparisons show that the energy of Indox V far exceeds Indox I . . . and is comparable to Alnico V, the strongest permanent magnet material commercially available.

Indox V offers high resistance to demagnetization. Indox V magnets can be designed for applications where extremely high demagnetizing forces exist . . . without irreversible losses occurring. This means it can be used where other types of magnets have been impractical . . . for example, in stators of medium-size electric motors where electromagnets are now being used.

JUST PUBLISHED! This two-page data sheet gives detailed information on new high energy Indox V. Use this coupon to request your copy. Ask for Bulletin 16-A3.

.. ideal for:

- D-C motors
- Synchronous drives
- Traveling wave tubes
- High-fidelity loud-speakers
- Eddy current drives
- Tractive devices where size is important

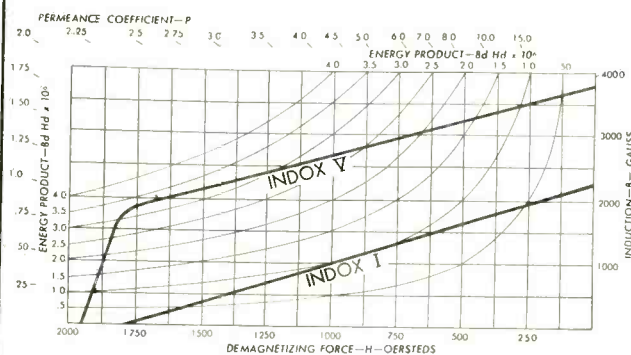

Comparison of demagnetization and energy product curve for conventional Indox I ceramic magnets and the new, high energy Indox V magnets.

INDOX V
New High Energy
CERAMIC PERMANENT MAGNETS

THE INDIANA STEEL PRODUCTS COMPANY • VALPARAISO, INDIANA
.. the world's largest manufacturer of permanent magnets

Name _____
Company _____
Address _____
City _____ Zone _____ State _____

16-A3

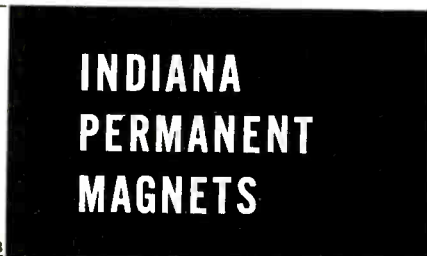

In Canada: The Indiana Steel Products Company of Canada Limited • Kitchener, Ontario



Peak-reading and average-reading WATTMETERS—POWER MONITORS



Sierra 195A-Z Termination Wattmeter

SIERRA TERMINATION WATTMETERS

Sierra 195A series Peak-Reading Termination Wattmeters are rugged, conservatively rated instruments specifically designed for measuring peak powers and terminating rf coaxial systems in testing and adjusting pulse transmitters and oscillators. They are designed for maximum reliability and minimum rf leakage. Three basic models cover 250 MC to 1000 MC and have characteristics given alongside. All require a 110 v 60 cps power source.

Sierra 185A series Average-Reading Termination Wattmeters are also offered for average-power measurement or termination on rf coaxial systems. The table at right gives models, frequency coverage, etc. No auxiliary power is required.

BI-DIRECTIONAL POWER MONITORS

Sierra Power Monitors are convenient, versatile instruments for measuring incident or reflected power, or precise matching of loads to lines. A twist of the wrist selects incident or reflected power, or any power range. Compact, rugged construction makes these instruments ideal for portable field applications or laboratory use.

Peak-Reading Sierra 194-A Bi-Directional Peak Power Monitor reads 0-1/3/10/30 Kw from 200 MC to 1215 MC. Minimum pulse width 1.0 μ sec, minimum repetition rate 400 pps, accuracy $\pm 10\%$ full scale. Insertion VSWR 1.10 maximum. Requires 110 v 60 cps power source.

Average-Reading Sierra 164 series Bi-Directional Power

TERMINATE RF COAX SYSTEMS

MEASURE RF POWERS

MEASURE INCIDENT, REFLECTED
POWERS

MATCH ANTENNAS, LOADS

MODEL 195A PEAK-READING WATTMETERS

Model	Frequency	Peak Power, Kw	Max. Average Power	Connector
195A-Z	250-1000 MC	0-1/3/10	15 watts	N
195A-X	250-1000 MC	0-10/30/100	100 watts	LC
195A-Y	250-1000 MC	0-100/300/1000	500 watts	LC

MODEL 185A AVERAGE READING WATTMETERS

Model	Frequency	Power Range, Watts	Max. Power Dissipation	Connector
185A-15FN	20-1000 MC	0-5/15	15 watts	N
185A-100FN	20-1000 MC	0-30/100	100 watts	N
185A-500FN	20-1000 MC	0-150/500	500 watts	N

Note: 185A series accuracy $\pm 5\%$ full scale maximum VSWR 1.2. 195A series accuracy $\pm 10\%$ full scale, pulse width 1.0 μ sec minimum, repetition rate 400 pps minimum. Female connectors standard.

Sierra also manufactures calorimeter wattmeters; details on request. Data subject to change without notice.

Monitors cover 25 MC to 1000 MC with as few as two plug-in elements. Each plug-in covers broad frequency range and has full scale power ranges of 1, 5, 10 and 50 watts or 10, 50, 100 and 500 watts. Power is read direct on linear scale within $\pm 5\%$ full scale. Insertion VSWR less than 1.08 (Type N connectors) except on 1 watt ranges. 50 ohm impedance available with Type N or UHF connectors. No auxiliary power required.



Sierra 194A-A

Sierra Electronic Corporation

A Subsidiary of Philco Corporation

3885 Bohannon Drive Davenport 6-2060 Menlo Park, California, U.S.A.

Sales Representatives in Major Cities

Canada: Atlas Radio Corporation, Ltd., Toronto, Montreal, Vancouver, Winnipeg
Export: Frazar & Hansen, Ltd., San Francisco, New York, Los Angeles



Booths
3905-3907



Motor - Gear - Trains

3:1 to 150,000:1 Ratio Range • Up to 18 Foot Pounds Torque

- Motors available: DC, 60 or 400 cycle, PM, split series, series, shunt, single phase and 2-phase. All are reversible.
- Available with either governor or brake.
- 1000 hour life minimum.
- Designed to meet MIL-E-5272A.
- Precision gearing throughout.
- Can be furnished up to 125°C.
- Designed for continuous duty or intermittent duty applications.



MOTOR GEAR TRAIN									Size	Overall Length Inches-Max.	Motor Type	Mounting	Oster Type
Gear Ratio	No-Load Speed	Nominal Voltage D.C.	Voltage Range D.C.	No-Load Current	Normal Speed	Normal Load OZ./IN.	Normal Current	Operating Temp. Range					
5.68:1	1800	28	24-32	0.4	1800	5.0	1.0	-55° To +85° C	13	3.777	P.M. GOVERNOR	FACE	13R-9102-08
17.9:1	600	28	24-32	0.4	600	12.0	1.0	-55° To +85° C	13	3.930	P.M. GOVERNOR	FACE	13R-9102-06
32.3:1	300	28	24-32	0.4	300	12.0	1.0	-55° To +85° C	13	3.935	P.M. GOVERNOR	FACE	13R-9102-02
67:1	150	28	24-32	0.4	150	12.0	0.6	-55° To +85° C	13	4.092	P.M. GOVERNOR	FACE	13R-9102-05
85:1	150	27.5	-	.25	130	50.0	0.7	-55° To +85° C	13	4.095	P.M.	FACE	13R-9101-11
109:1	100	28	24-32	0.4	100	32	0.6	-55° To +85° C	13	4.094	P.M. GOVERNOR	SYNCHRO	13R-9102-12
109:1	180	27.5	-	0.4	175	30	0.5	-55° To +100° C	13	2.843	P.M.	FLANGE	13R-9104-01
125:1	75-90	28	-	.25	70-85	20	0.3	-55° To +71° C	13	3.920	P.M.	FACE	13R-9101-13
157:1	60	28	24-32	0.4	60	12.0	0.6	-55° To +85° C	13	4.095	P.M. GOVERNOR	FACE	13R-9102-03
285:1	48	35	-	.25	40	160	0.6	-55° To +71° C	13	4.038	P.M.	FACE	13R-9103-01
333:1	30	28	24-32	0.4	30	12.0	0.6	-55° To +85° C	13	4.317	P.M. GOVERNOR	FACE	13R-9102-04
410:1	15	27	25-29	0.3	15	8.0	0.3	-55° To +85° C	13	4.400	P.M. GOVERNOR	FACE	13R-9102-11
1043.8:1	5-10	27	24-30	0.15	7	30	0.2	-55° To +71° C	13	4.450	P.M. BRAKE	FACE	13R-9105-01
1044:1	5-10	27	24-30	0.15	7	30	0.2	-55° To +71° C	13	3.910	P.M.	FACE	13R-9101-12
2214:1	3-4	6	-	1.2	3.4	30	1.2	-55° To +71° C	13	4.454	P.M.	FACE	13R-9101-04
3241:1	5.5	35	-	.35	5.5	18	0.4	-55° To +71° C	13	4.454	P.M.	FACE	13R-9101-03
5933:1	1.3	30	-	.13	1.3	30	0.15	-55° To +71° C	13	4.816	P.M.	FACE	13R-9101-10
21,707:1	2-3	120	-	.25	2-3	12	0.25	-55° To +71° C	13	3.475	P.M.	FLANGE	13R-9101-16
322:1	80	110	-	0.2	30	240	0.3	-55° To +71° C	15	3.815	SPLIT SERIES	FLANGE	15R-9201-01
407:1	22	27	-	0.2	20	8	0.2	-20° To +50° C	15	3.989	SPLIT SERIES	SYNCHRO	15R-9201-03
433:1	30	26	-	0.6	25	260	1.2	-50° To +80° C	15	3.110	SHUNT	FACE	15R-9201-02
955:1	33	27	-	0.6	12-18	420	1.0	-55° To +50° C	15	4.419	SPLIT SERIES	FLANGE	15R-9201-08
26:1	240	27.5	24-29	0.65	240	40	1.3	-18° To +71° C	17	5.315	SHUNT GOVERNOR	SYNCHRO	17R-9251-01
4.26:1	1800	28	-	0.6	1800	12	1.85	-30° To +55° C	24	4.640	SHUNT GOVERNOR	FACE	24R-9451-01

Speed tolerance on governed motors is $\pm 2\%$ over voltage and an ambient temperature range. Closer speed tolerance units can be designed to fit the particular application.

Many other variations available. There is an Oster motor-gear-train to fit your exact specification. Consult Oster specialists today, sending your detailed requirements.



MANUFACTURING COMPANY
Your Rotating Equipment Specialist
AVIONIC DIVISION
Racine, Wisconsin

Other products include servos, synchros, AC drive motors, DC motors, servo mechanism assemblies, synchro indicators, servo torque units, reference and tachometer generators, actuators, motor driven blower and fan assemblies and fast response resolvers.

Engineers For Advanced Projects:
Interesting, varied work on designing transistor circuits and servo mechanisms.
Contact Mr. Zelazo, Director of Research, in confidence.

Fast, convenient, dependable precision wave analyzers frequency-selective voltmeters



Sierra 121A Wave Analyzer

Sierra now offers exactly the instruments you need for wave analysis, wire carrier and microwave subcarrier applications.

Sierra 121A Wave Analyzer is a highly selective, double superheterodyne receiver covering frequencies from 15 KC to 500 KC and providing wave analysis data directly in voltage and dbm at 600 ohms. The instrument offers the selectivity required for use with new single sideband carrier systems.

Sierra 158A Wave Analyzer is similar but covers frequencies from 500 KC to 10 MC.

Both analyzers have high selectivity, accuracy of ± 2 db, spurious response at least 50 db down, and a signal-measurement range of 77.5 μ v to 97.5 volts. The instruments are supplied in cabinet mountings which are readily adaptable to relay rack mounting.

SPECIFICATIONS — SIERRA VOLTMETERS

Model	Frequency Range — kc	Selectivity		Accuracy		Direct Reading in dbm	
		Down 3db	Down 45db	Frequency	Measuring	Balanced	Unbalanced
101C	20-500	± 550 cps	± 2900 cps	Note A	± 3 db	Note D	600 ohms
103B†	3-40	± 400 cps	± 3000 cps	± 0.5 kc	± 3 db	Note D	600 ohms
104A	5-150	± 300 cps	± 1500 cps	± 1 kc	± 3 db	Note D	600 ohms
108B	15-500	± 550 cps	± 2900 cps	± 3 kc Note B	± 2 db Note C	Note D	600 ohms
114A	100-800	± 550 cps	± 2900 cps	Note A	± 3 db	Note D	600 ohms

All Sierra Carrier Frequency Voltmeters feature built-in calibration oscillators and circuits for level calibration, have aural monitoring jacks, and (except 103B) are furnished with Sierra Model 149A Precision Spiral Scale Dials.

† Contains carrier re-insertion oscillator for monitoring suppressed carrier systems. Furnished with planetary drive dial. Note A. Ranges from ± 2 KC at low end of dial to ± 3 KC at upper end. Note B. ± 1 KC in the 48 KC to 256 KC region. Note C. ± 1 db for $+30$ db to -40 db attenuator steps on 135 ohm balanced measurements. Note D. All models may be converted for 135 and 600 ohm balanced line measurements by convenient plug-in bridging transformer, Model 130D.



Sierra 101C Carrier Frequency Voltmeter

For carrier system and other field or laboratory work between 3 kc and 800 kc, Sierra offers 5 accurate, stable, tuned vacuum tube voltmeters. All are direct reading in voltage and dbm at 600 ohms from -80 dbm to $+42$ dbm.



Line Bridging Transformer

Model 130D Dual Impedance Line Bridging Transformer converts VTVM and wave analyzer inputs from single-ended to balanced operation. Covers 3 kc to 500 kc, bridges both 135 and 600 ohm balanced lines.

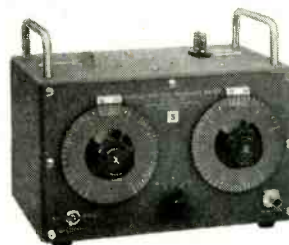

Impedance Meter, Line Fault Analyzer

Sierra 166 Impedance Meter (at left) measures impedance on high noise circuits, 30 kc to 300 kc; measures on "hot" lines through coupling capacitor. *Sierra 124 Line Fault Analyzer* pin-points shorts, opens or grounds on open wire lines. Direct reading, range $\frac{1}{2}$ to 200 miles, accuracy $\frac{1}{4}$ mile.

Data subject to change without notice.

sierra



Booths
3905-3907

Sierra Electronic Corporation

A Subsidiary of Philco Corporation

3885 Bohannon Drive Davenport 6-2060 Menlo Park, California, U.S.A.

Sales Representatives in Major Cities

Canada: Atlas Radio Corporation, Ltd., Toronto, Montreal, Vancouver, Winnipeg

Export: Frazar & Hansen, Ltd., San Francisco, New York, Los Angeles

From the idea...

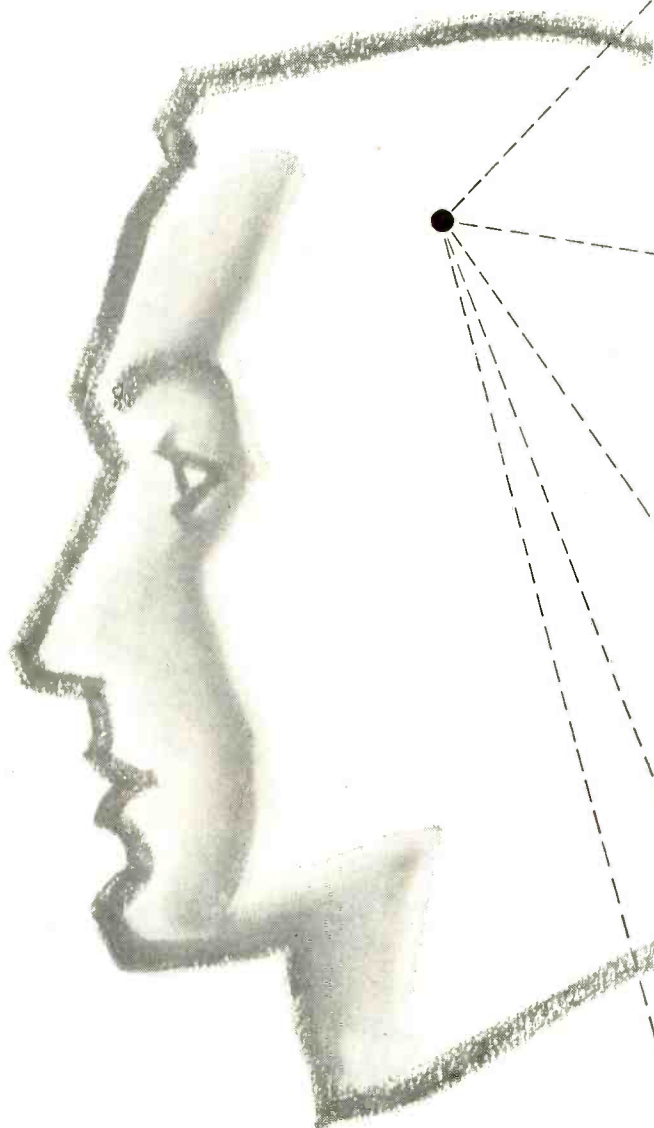

Headquarters for the Division, the Waltham Laboratories, in Waltham, Massachusetts, specialize in advanced systems related to guided missiles, avionics, radar, data processing and electronic warfare.

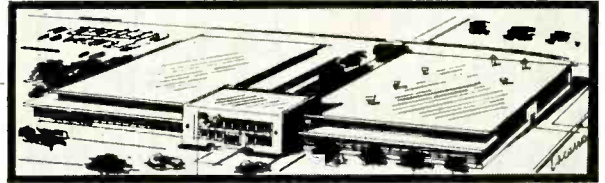

The Electronic Defense Laboratory, Mountain View, California, is a special development facility devoted to research, technical development and rapid fabrication of ground-based electronic warfare systems.

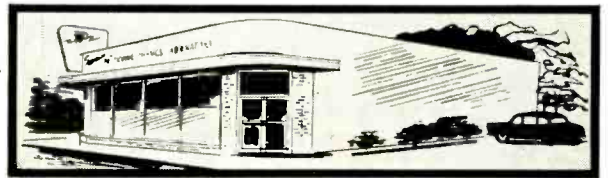

The Microwave Physics Laboratory, at Mountain View, California, is devoted to the investigation of new magnetic materials and ionized gaseous media for microwave control devices used in radar, communications and electronic countermeasures systems.

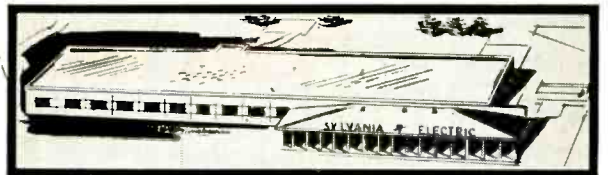

The Microwave Tube Laboratory, Mountain View, California, is engaged in developing and producing special tubes such as klystrons, traveling wave tubes, backward wave oscillators, and related devices.

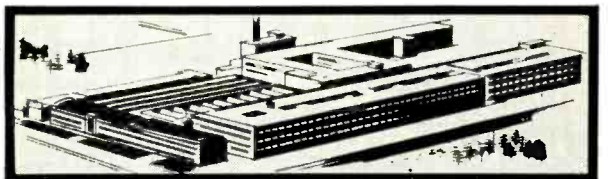

Buffalo Engineering Laboratory and manufacturing facilities for the Division occupy some 170,000 square feet of floor space in this industrial center. The Laboratory specializes in the development of advanced communications techniques and equipments.

...to automated mass production

The Sylvania ESD family is equipped to carry out your electronics development programs . . . large or small.

Backed by the corporation as a whole, Sylvania's Electronic Systems Division has a long record of successful problem solving in both military and industrial electronics. It has made many important contributions in the fields of avionics, guided missiles, countermeasures, communica-

tions, radar, computers and control systems.

Staffed with top-ranking scientists and engineers, backed by extensive research facilities and modern automated mass production capabilities—the Sylvania Electronic Systems Division is a major contributor to our national arsenal for defense. Intensive specialization in the Weapons Systems concept has resulted in

utmost organizational efficiency, as well as the highest order of technical and management competence.

Whether your project requires management or technical experience for complex integrated systems, subsystems, equipments or special components, from initial concept through mass production, Sylvania engineers will be glad to discuss methods of solving your specific problems.



SYLVANIA

SYLVANIA ELECTRIC PRODUCTS INC.
Electronic Systems Division
100 First Avenue, Waltham, Mass.

LIGHTING • RADIO • TELEVISION • ELECTRONICS • ATOMIC ENERGY

**bigger things
in smaller
packages...**

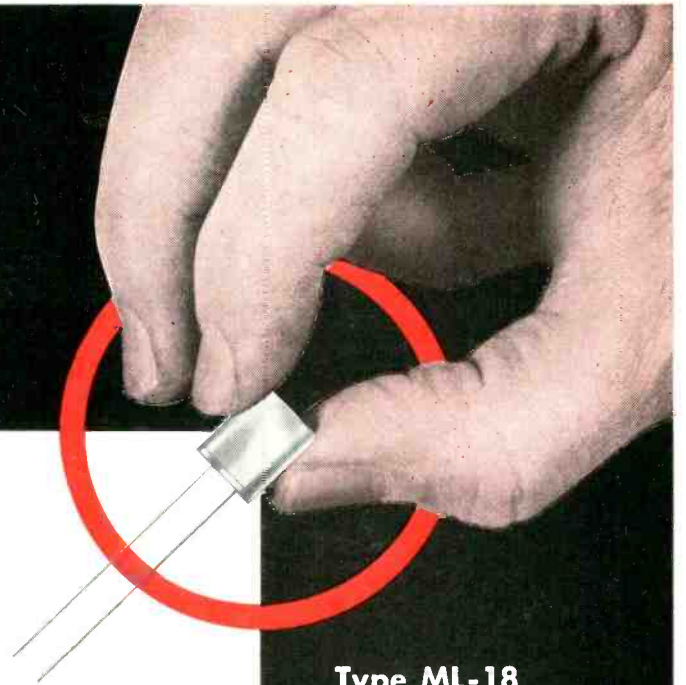

Midland CRYSTALS

**pack king-size performance
in finger-tip space**

"Make it smaller — and make it BETTER!" Miniaturization is a military necessity and an industrial demand for all electronics equipment.

Midland meets it with frequency control crystals of Lilliputian proportions and titanic efficiency. Like their "big brothers" that made Midland first choice in two-way communications the world over, Midland miniatures and sub-miniatures are masterpieces of accuracy, stability and uniformity — everything you want in a crystal — guaranteed by Midland's Critical Quality Control.

Have a special crystal problem? Whether it's in miniaturized or conventional application, our engineering staff is ready to help (including development and production of crystals tailored to your individual requirements.) Get in touch with us.

Type ML-18

Range: 5.0 mc — 150 mc

Wire pin diameter: $.017 \pm .001$

Wire pin length: $1.500 \pm .062$

Fixed pin diameter: $.040 \pm .002$

Fixed pin length: $.234 \pm .030$

Whatever your crystal need, conventional or highly specialized, when it has to be exactly right, contact...



Midland MANUFACTURING COMPANY, INC.

3155 Fiberglas Road • Kansas City, Kansas

WORLD'S LARGEST PRODUCERS OF QUARTZ CRYSTALS

Solve core problems quickly, economically with

FERRITE COMPONENTS by GENERAL CERAMICS

HUNDREDS OF STANDARD PARTS
plus CUSTOM DESIGNING TO SPECIFICATIONS



STANDARD
ANTENNA RODS



THREADED
TUNING CORES



STANDARD
EI CORES



CUP AND
TOROID CORES



TELEVISION
COMPONENTS



RECORDING
HEADS

**Performance proven magnetic ferrites available
for every electronic application**



**Computer and
Automation Systems
Designers!**

Ferramic memories provide a new design concept in the area of computers and automation. Magnetic memories combine increased speed, accuracy and reliability with light weight, compact size. Write for bulletins on cores or complete memory planes.

General Ceramics ferrites for television, radio and instrumentation offer designers and engineers a wide range of economical standard components. All are application tested for highest efficiency electrically and mechanically. The fact that leading electronic manufacturers specify Ferramics is due to the program of continuing research and equipment modernization by which General Ceramics keeps pace with the industry's needs as to quality *and costs!* Bulletins are available; write to General Ceramics Corporation, Keasbey, New Jersey, Dept. E.

GENERAL CERAMICS

Industrial Ceramics for Industrial Progress... Since 1906

See us
at the
I.R.E. Show!
Booth 1319

Manufacturers of FERRAMIC CORES, MAGNETIC MEMORY CORES, MEMORY PLANES, MICROWAVE FERRITES, SOLDERSEAL TERMINALS, HIGH TEMPERATURE SEALS, STEATITE, ALUMINA & CHEMICAL STONWARE

NEW NORTHERN RADIO REGENERATIVE REPEATER

Type 207 Model 1
*the most advanced
in the industry!*



*for teleprinter,
half duplex and
synchronous binary
operation*

The new Northern Radio Regenerative Repeater is designed for use in telecommunication circuits to re-shape and re-time distorted signals for local use or retransmission. Special provision has also been made for use of this unit on half duplex circuits — where it will not only regenerate the ordinary teleprinter signals but also faithfully reproduce such special signals as "break" signals and "mark restoration" information.

Further provision has been made for use of this Regenerator with synchronous binary signals on either single channel circuits or multi-channel time division multiplex systems. Provision is made to synchronize this unit from an external source.

- **Maximum Acceptable Signal Distortion:** new circuitry accepts up to 47% mark or space distortion.
- **"Floating" Input & Output Circuits:** completely electronic output, no relays.
 - **Greater Timing Circuit Stability:** time base derived from highly stabilized L-C oscillator.
- **Switch Selection of Speeds:** 60, 75, 100 words per minute.
 - **Adaptable to Any Speed:** low-pass filter & frequency-determining elements are plug-in units.
- **Completely Self-contained:** includes power supply and line battery.
- **OUTSTANDING DUPLEX FEATURES:**
 - faithfully reproduces "break" signals
 - transmits "break" signal in case of line failure
 - protected against "space lock-out"
 - output can be open-circuited with no excessive rise in line voltage & no harm to the Repeater
 - 22 front panel test points for equipment function and 8 jacks for input & output line, equipment, current and voltage measurements

**Input Keying
Signal
Requirements:**

- (1) Neutral keying, positive or negative sense
 - (a) on-off 60 ma pulses (40 ma min)
 - (b) on-off voltage pulses 10-100V into 100K ohms
- (2) Dry contact keying

**Frequency
Stability of Time
Base Generator:**

Less than 1 point range loss for $\pm 10\%$ line voltage variation or $\pm 20^\circ$ C ambient change from 25° C

Sampling Time:

Approximately 50 micro-seconds

Output:

Electronic tube outputs:
(a) neutral 65 ma max. into 2K ohms
(b) polar 33 ma (max.) into 2K ohms

**Output
Distortion:**

- (a) Signal bias distortion less than 0.5%
- (b) Signal element random jitter less than 1%
- (c) Signal history (duty cycle) distortion less than 0.5%
- (d) Total distortion less than 2%

**Power
Requirement:**

125 watts approx: 110/220V, 50/60 cps

Mounting:

Standard 19" rack mounting, 5/4" panel

Write for free 67-page catalog. See us at Booth 1423, IRE SHOW

Pace-Setters in Quality Communication Equipment

NORTHERN RADIO COMPANY, inc.

147 WEST 22nd ST., NEW YORK 11, NEW YORK

In Canada: Northern Radio Mfg. Co., Ltd., 1950 Bank St., Billings Bridge, Ottawa, Ontario.



Electron-Tube Transconductance (gm) Tester measures Electrode Currents as low as 0.0000001 ampere!

RCA WT-100A MicroMhoMeter enables equipment design engineers to measure electron-tube grid and interelectrode-leakage currents for critical circuit applications

Typical analysis and measurement of reverse and forward grid currents

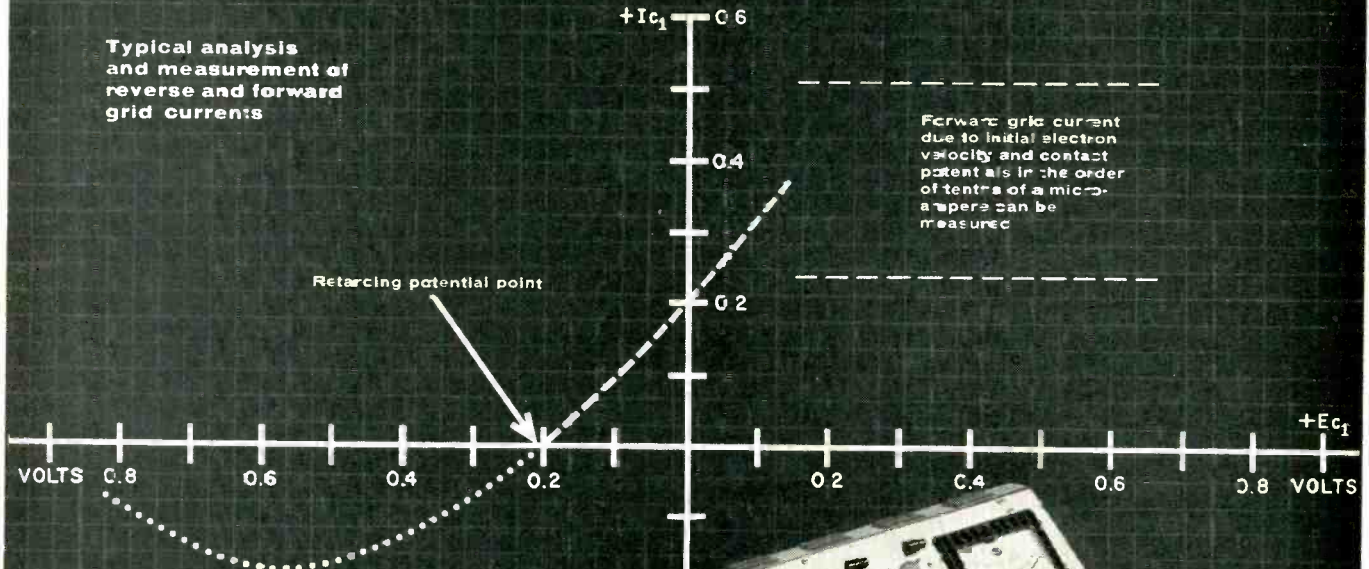

Forward grid current due to initial electron velocity and contact potentials in the order of tenths of a microampere can be measured

Reverse grid currents due to gas, grid emission, and leakage in the order of tenths of a microampere can be measured

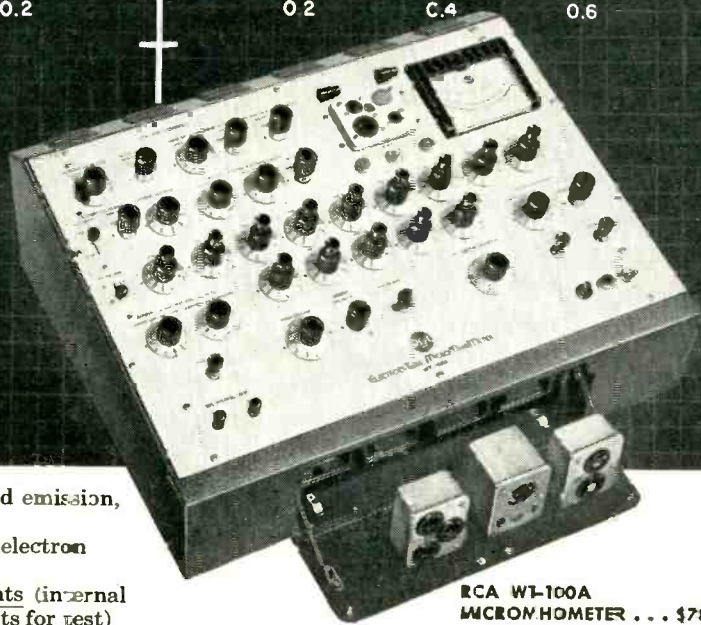

RCA WT-100A
MICROMHOMETER . . . \$785.00**

- measures reverse grid currents (gas, grid emission, and leakage currents)
- measures forward grid currents (initial electron velocity and work-function currents)
- measures heater-cathode leakage currents (internal power supplies provide -100 to +300 volts for test)
- measures interelectrode leakage currents between any combination of electrodes (internal power supplies provide -100 to +300 volts for test)

**User Price (optional)

RCA WT-100A Electron-Tube MicroMhoMeter is a laboratory-quality instrument which brings a reliable concept of tube-testing technique to users of tubes—on the production line, in the laboratory, and in circuit design. Uniquely designed, compact, and self-contained, the WT-100A offers versatility and accuracy comparable to that of more elaborate and complex laboratory equipment used for measuring transconductance and electrode currents. For detailed brochure, write RCA, Commercial Engineering, Section C19W, Harrison, N. J.



TEST EQUIPMENT

Radio Corporation of America
Components Division, Camden, N. J.

SPECIAL FEATURES OF THIS REMARKABLE INSTRUMENT

- Measures true transconductance with better than $\pm 3\%$ accuracy
- Built-in shorts test for any combination of tube elements
- Measures transconductance up to 100,000 μmhos —in 6 ranges
- Measures transconductance of low-plate-resistance types and high-perveance types
- Measures control-grid-to-plate, screen-grid-to-plate, and suppressor-grid-to-plate transconductances
- Measures heater currents including 600-ma series-string TV types
- Built-in calibrating circuit—no null meters or extra devices required
- Has easy-to-read meter for all measurements
- VoltOhmyst*-type circuit for current measurements—has full-scale reading of 3 μamps on lowest current range
- Electronically protected burn-out-proof meter
- Regulated power supplies for all dc voltages
- 250-ma dc supply for filaments of battery operated tube types.

*Registered U.S. trademark

NEW 10 Amp Relay

30g to 2000 cps 60 Amp Overload 80 Amp Rupture

Type CH-12D

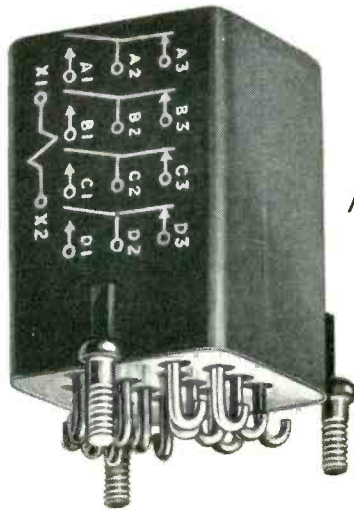

Actual Size

Here are the facts:

Contact Rating: 10 amperes resistive at 30 volts d-c and 115 volts, 400 cps
 Overload—60 amperes
 Rupture test—80 amperes

Contact Arrangement: 4 PDT

Coil: 26.5 volts d-c, 170 ohms (other resistances are available)

Temperature: -65°C to +125°C

Vibration: 30 g to 2000 cps

Operating Shock: 100 g.

Weight: 5 oz.

Military Specifications:

Meets test conditions of—
 Mil-R-5757B • Mil-R-6106A • Mil-R-25018

For more information, write for Bulletin CH

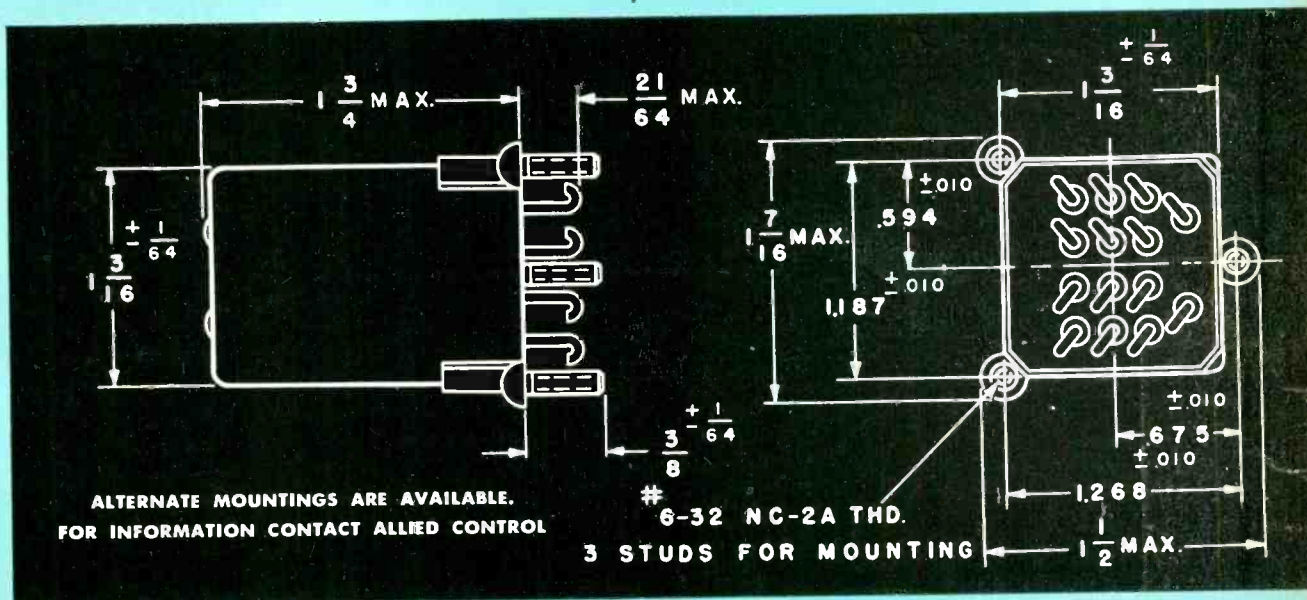

ALLIED CONTROL



ALLIED CONTROL COMPANY, INC., 2 EAST END AVENUE, NEW YORK 21, N. Y.

ALLIED'S

NEW

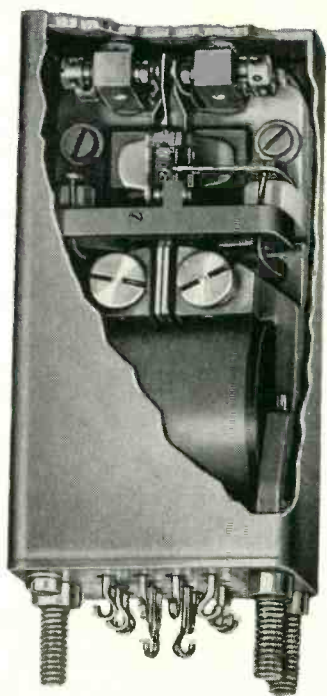

Allied Types
Trls 163-169

Actual Sizes

This new polarized relay, designed and manufactured by Siemens & Halske Company of Germany, is now available from Allied Control, and in the near future will be produced by Allied with the technical assistance of Siemens & Halske.

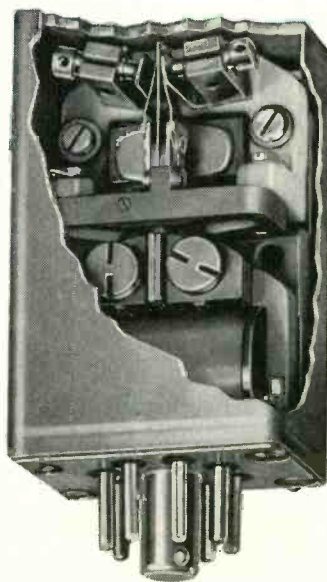

Allied Types
Trls 193-199

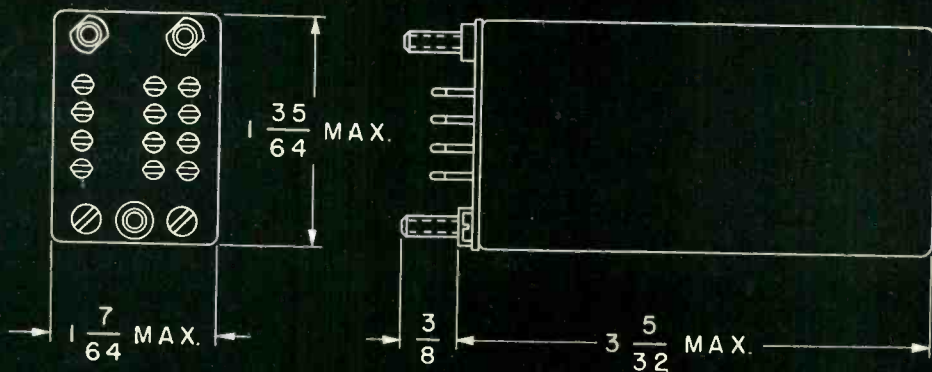

Trls 163-169 with SOLDER TERMINALS

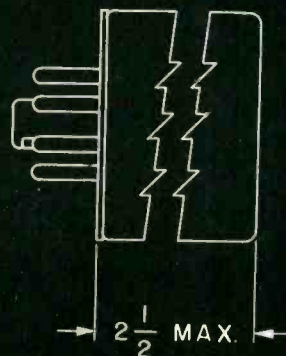

Trls 193-199
with OCTAL BASE

Sealed **POLARIZED RELAYS**

Specifications for Allied's
Types Trls 163-169 and Trls 193-199

Type Number		Trls 163 Trls 193	Trls 164 Trls 194	Trls 165 Trls 195	Trls 166 Trls 196	Trls 167 Trls 197	Trls 168 Trls 198	Trls 169 Trls 199
Description	Positions	2		3	2	2	3	2
	Operation	Magnetic Latch		Null Center	Magnetic Latch	Spring Biased	Null Center	Spring Biased
High Contact Pressure		High Sensitivity						
Contact Arrangement		SPDT		SPDT	DPDT	SPDT	DPDT	DPDT
"Operate" Excitation (Std.)	Amp. Turns	7	2	2.2	5.5	5	4	15
"Operate" Power	Trls 163-169	500	40	50	300	250	160	2250
	Trls 193-199	μ Watts	610	49	61	375	300	195
"Working" Excitation	Amp. Turns	15	4	6	10	10	10	25
"Release" Excitation	Amp. Turns			2.2		2.4	4	5
Max. Rate of Operation	Oper./Sec.	200	200	200	200	100	200	100

Shock and Vibration: The degree of shock and vibration resistance is related to the type of operation, the adjustment, the coil input power and the application. Contact Allied Control for ratings for your specific application.

Contacts:	Silver, General Purpose 2 amp., 28v d-c resistive load
	Platinum Alloy A. Low-Level Applications up to .5 amp.
	Platinum Alloy B. Heavy Duty Applications above .5 amp.
	Max. Continuous Current 5 amps.

Dielectric Test Voltage	Coil to Frame	500v rms.
	Contact to Contact	350v rms.
Standard Coils	Contact to Frame	500v rms.
	Winding to Winding	150-500v rms.
Temperature	Resistances from 1.1 to 18,000 ohms	
	Max. number of windings	3
	Max. Continuous Loading	1 watt
	Max. Ambient	85°C



ALLIED CONTROL



ALLIED CONTROL COMPANY, INC., 2 EAST END AVENUE, NEW YORK 21, N. Y.

ALLIED CONTROL'S

New

CRADLE RELAYS

These new telephone type relays meet the requirements of modern equipment for a small versatile and economical relay. Designed and manufactured by Siemens & Halske Company, Germany, the cradle relay series are now available from Allied Control. In the near future these relays will be produced by Allied with the technical assistance of Siemens & Halske. • For complete information on these relays write for Bulletin 52.

Specifications

Pull-in Power at 25° C:

.035 watt to .140 watt

Contact Arrangements:

up to 6 make or 6 break or 4 pdt

Contact Rating:

1 or 5 amp, 30v d-c or 115v a-c

Max. Coil Loading:

1.5 watts

Coil Voltages:

From 1v d-c to 140v d-c

Coil Resistance:

From 1.3 ohms to 15,000 ohms

Speed of Operation:

10 ms max. at 1 watt

Shock: 25 G's

Vibration:

10-55 cps at .062" double amplitude
55-500 cps 8 G's

Actual Size

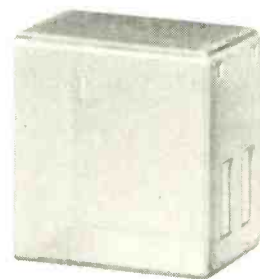
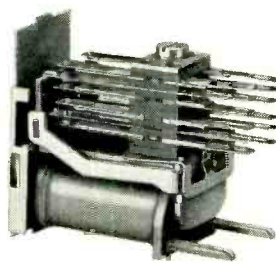

ALLIED TYPE Trls 151

Available in two sizes (x or y) with solder terminals and transparent dust cover.

For Types Trls 151 and 151H low capacitance wire contact pile-ups are also available.

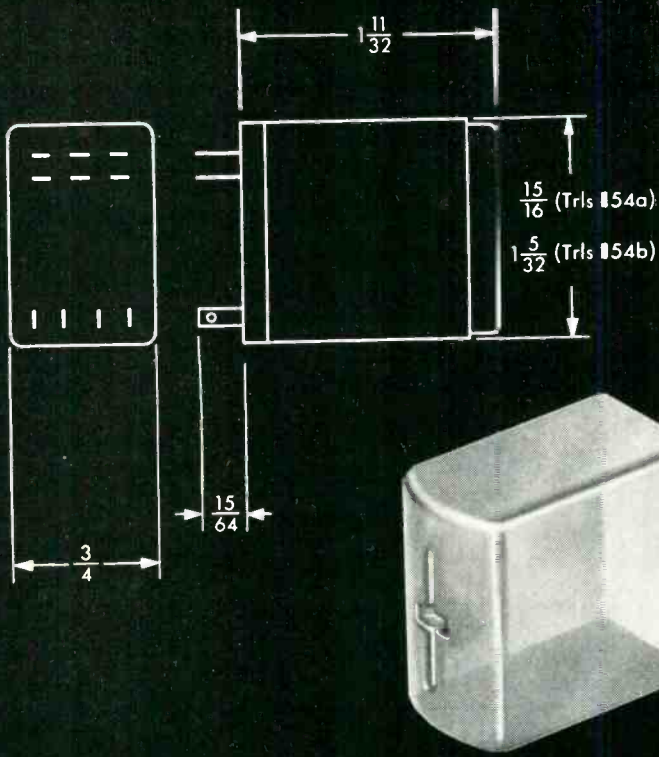

**ALLIED
TYPE Trls 154**

Available in two sizes (a or b)
with plug-in base, transparent dust
cover, and special socket.

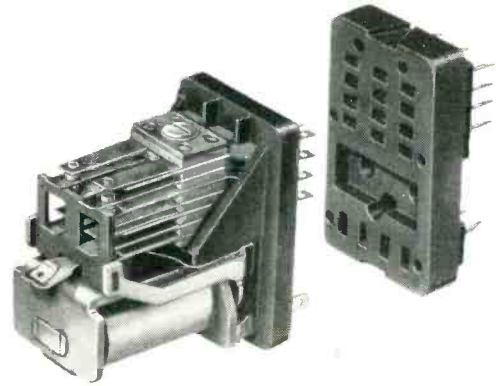

Actual Size

**DIMENSIONS SHOWN
ARE MAXIMUM**

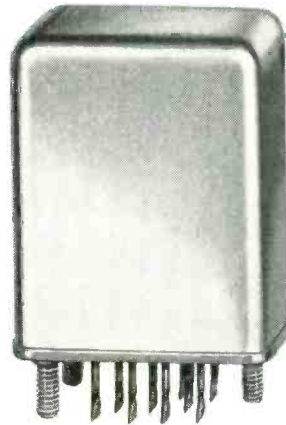
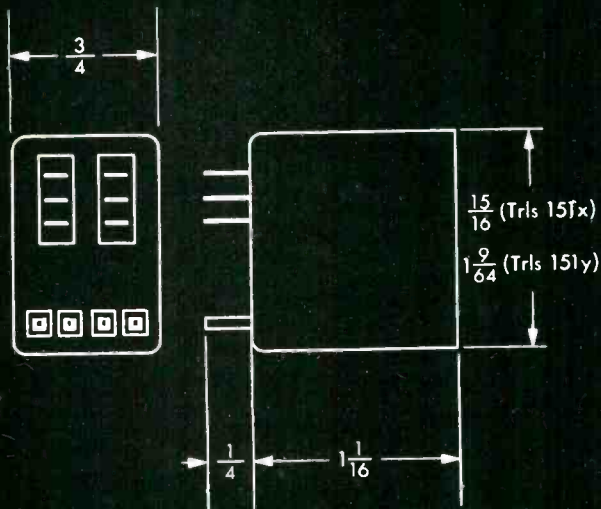

**ALLIED
TYPE Trls 151H**

This is an hermetically
sealed version of
Allied's Type 151.

Actual Size

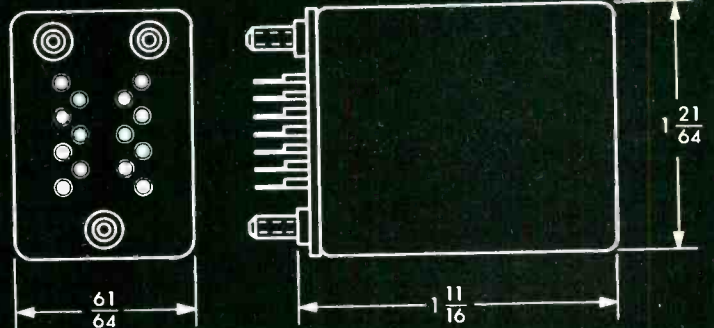

ALLIED CONTROL



ALLIED CONTROL COMPANY, INC., 2 EAST END AVENUE, NEW YORK 21, N. Y.

Tailor-Made Fasteners in Volume Quantities

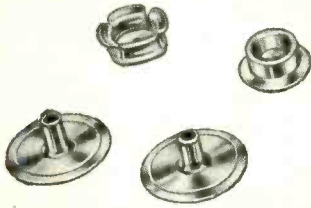

MINIATURE BATTERY CONNECTORS

For use with small "B" batteries; afford quick and positive polarized electrical connections and worthwhile space savings on small electronic equipment.



POLYETHYLENE MOUNTING FOOT

No mar no scratch glide for use on TV receivers, record changers and small appliances. Assembles into round hole in either wood or metal cabinets.

FISHTAIL RATCHET PLATE

Made in a wide range of sizes to hold on smooth metal, die-cast or plastic studs. For use on refrigerators, radio cabinets, washing machines and other products to hold medallions, name plates, etc.

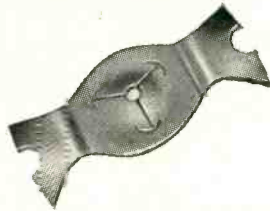

VIBRATOR GROUNDING FASTENERS

Holds 1 1/2" dia. beaded or non-beaded vibrator. Vibrator Can grounded to chassis. Holding prongs designed to hold several types of Cans.



RUBBER FOOT

Snap-in Rubber Foot for Record Changers and Phonograph Mountings eliminates threaded member, lock washer and nut thereby speeding assembly time and reducing costs.



NYLON COIL NUT

Designed to snap into a TV tuner and receive a 4-40 or 4-48 coil adjusting screw. No coil form or coil form fastener required.

SPEAKER MOUNTING BOLT

Pronged head prevents bolt from turning in speaker panel during application of nut and lock washer, permits one-side attachment providing production-line savings.

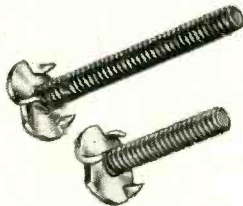

NYLON SNAP-IN NUT

Serves as insulator between "hot TV chassis" and cabinet. Snaps into square chassis hole and secures to cabinet with sheet metal screw.

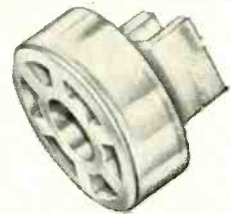

PLUG BUTTONS

Made to snap into hole sizes 1/8" to 3". Can be embossed with ornamental or functional designs. Removable. Supplied with various finishes, in a variety of shapes and sizes.



QUICKEY FASTENER

Eliminates need for welding or swaging studs to sheet metal stampings, facilitates nesting, eliminates damage in transit because Quickey snaps in just before final assembly.

TRIMOUNT STUDS

Designed to hold two or more thicknesses of material together. Easily installed by hand. Insure vibration proof attachment. Permanent or removable attachment. Wide variety of shapes and sizes.



DOT
©

Parts illustrated are representative of the thousands of different specialized fasteners and allied devices designed and manufactured in volume by United-Carr and its subsidiaries for leading manufacturers of electronic equipment. United-Carr's wide and varied experience with special fastening problems in the automotive, aviation and appliance fields provides an unequalled background of technical knowledge which may well be applicable to your special needs.

UNITED-CARR
FASTENER CORP.

CAMBRIDGE 42, MASSACHUSETTS

BOOTHS 2533 to 2536 I.R.E. SHOW

Ucinite Electrical Assemblies

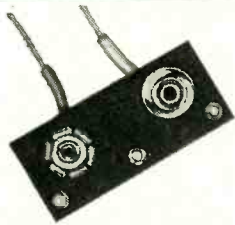

BATTERY CONNECTORS

Wired snap-on units for use with batteries equipped with United-Carr electrical snap fasteners. Wiring to customer's specifications.



BANANA PINS

Four sizes of plugs with one-piece beryllium copper springs. Adaptable mounting ends in threaded, staking, or solder lug types. Similar Mating Jacks also available.

SHOCK MOUNTS

Offered in several sizes—brackets and durometer of rubber bushings can be varied. With threaded Teenuts or plain bushings. Insulated versions if needed.

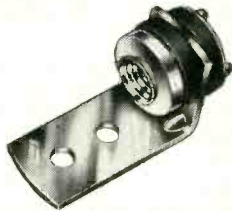

ANODE CONNECTORS

Plug button contacts for positive firm connections. Corona resistant neoprene or silicon shields in straight or right angle types. Wiring to customer's specifications.

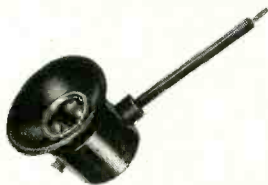

TUBE CAPS

Positive gripping, heat treated steel springs in corona resistant metal housing. Insulated or non-insulated. Wired to specifications. Type shown has silicon shield for special application.

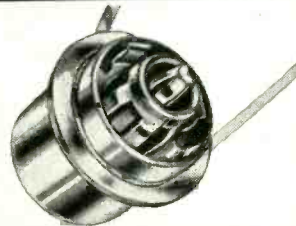

MAGNETRON CONNECTORS

For heater and heater cathode terminals of magnetrons. Available in many variations to answer specific needs.

SWITCHES

Oak type switches manufactured as a licensee. Variety of rotary and push-button assemblies to specifications.

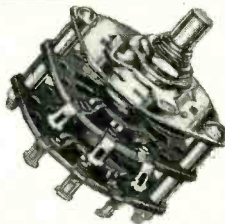

SNAP SWITCHES

Precision, momentary contact push-button switches. Small and dependable. Several circuit arrangements. Water tight version shown.



TEST JACK

Ucinite's quality jack for .080 probes. Beryllium copper contacts. Nylon insulation in colors. Metal shell for firm dependable mounting.

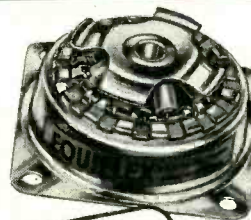

VIBRATION ISOLATORS

Equiflex (1 to 1 ratio) metal mounts ensure long life, fit small spaces, can be used in any direction. Three sizes, cup or plate mountings.

METAL STAMPINGS

Volume production in Metal stampings. Years of engineering and tooling skill available to solve your particular problem.

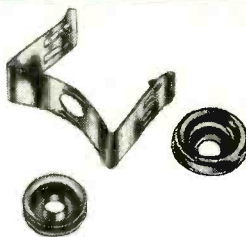

With years of specialized experience in the electronics field and complete facilities for the volume production of small metal stampings as well as the assembly of metal to plastic and ceramic components, Ucinite is fully equipped to supply you with special electrical parts and assemblies... designed, assembled, wired and marked to your specifications. For complete design, engineering and production service, call your nearest Ucinite field engineer.

The UCINITE Company

DIVISION OF UNITED-CARR FASTENER CORP.

Newtonville 60, Massachusetts

BOOTHS 2533 to 2536 I.R.E. SHOW



PHOTO COURTESY OF U.S. NAVY

Where there must be no slipups there will be no slipups — if you depend on CTC

Looking for reliability?

CTC guarantees its components unconditionally — in any quantity from one to millions. CTC quality control includes material certification, step-by-step inspection in production, and finally rigid inspection of finished product. There is reliability for you.

For samples, specifications, and prices, write to Sales Engineering Department, Cambridge Thermionic

Corporation, 437 Concord Avenue, Cambridge 38, Mass. West Coast stocks maintained by E. V. Roberts

& Associates, 5068 West Washington Blvd., Los Angeles 16 and 988 Market St., San Francisco, Calif.

CTC

CAMBRIDGE THERMIONIC CORPORATION

*makers of guaranteed electronic components
custom or standard*



See CTC's Guaranteed Components on Display at Booth 2219, IRE Show, New York Coliseum, March 18-21

Ten families of CTC quality components — guaranteed unconditionally in any quantity

CTC QUALITY SHIELDED COIL FORMS

Miniaturized. Highly shock resistant. Mechanically enclosed, completely shielded for maximum reliability.

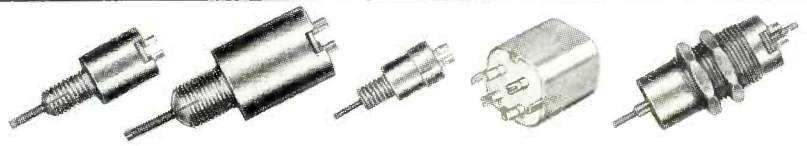

CTC QUALITY CAPACITORS

Miniaturized Variable Ceramic Capacitors that outperform much bigger capacitors. (*Extreme right*): Stand-Off Capacitors with ceramic dielectric. Rugged R-F by-pass capacitors for high quality equipment. Shock-, vibration-, humidity-resistant.

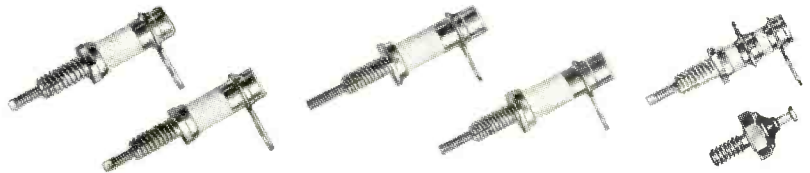

CTC QUALITY WOUND COILS IN STANDARD VALUES

Precision wound on slug-tuned ceramic coil forms, with silicone Fibreglas collars and mounting hardware. Available in bulk or in kit form (illustrated).

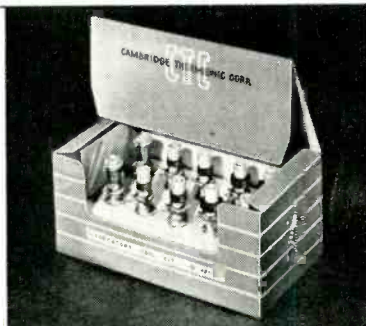

CTC QUALITY KITS

Design your electronic equipment around standard components, using four convenient CTC kits: Coil Form Kit, Coil Kit, Choke Kit, Solder Terminal Kit (illustrated).



CTC QUALITY DIODE CLIPS

Seven different types, including spring-loaded units primarily for holding fragile diode pigtail leads from .005" to .085" in diameter. CTC also offers lines of quality battery clips and miniature plugs and jacks.



CTC QUALITY TERMINAL BOARDS

Custom-made, standard all-sets, standard ceramics. Variety of materials available — paper, cloth, nylon, glass laminates — phenolic, melamine, epoxy, silicone resins. Moisture — and fungus-proofed.

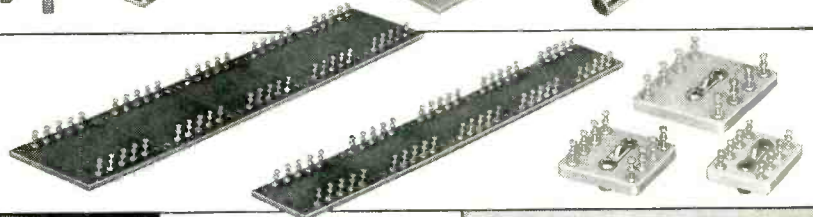

CTC QUALITY PERMA-TORQ COIL FORMS

Constant-tensioning devices for tuning cores of standard CTC ceramic coil forms. Keeps coils tuned as set despite shock, vibration.

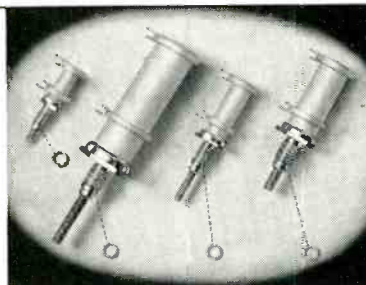

CTC QUALITY KNOBS AND PANEL HARDWARE

Selected materials, carefully processed and finished. Metal parts polished before plating. Hard-wearing surfaces, lasting lusters.

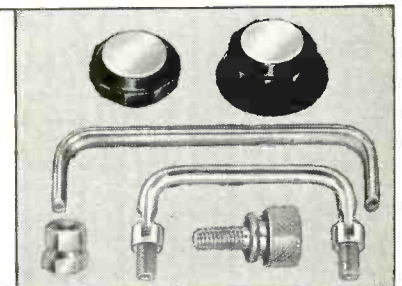

CTC QUALITY INSULATED TERMINALS

Wide variety of stand-off and feed-through models in Teflon and ceramic. Extremely resistant to shock, vibration, moisture and temperature. Solder terminals hold even after prolonged soldering operations.

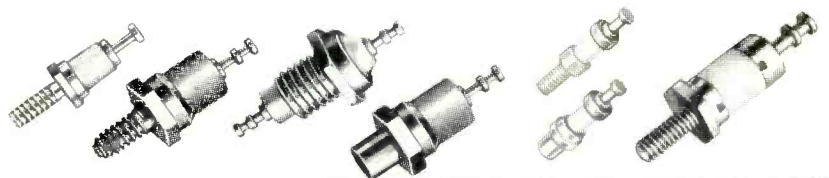

CTC QUALITY PRINTED CIRCUIT COIL FORMS

Phenolic and ceramic types. Can be soldered after mounting. Available as forms alone or wound as specified. Two- to six-terminal models.

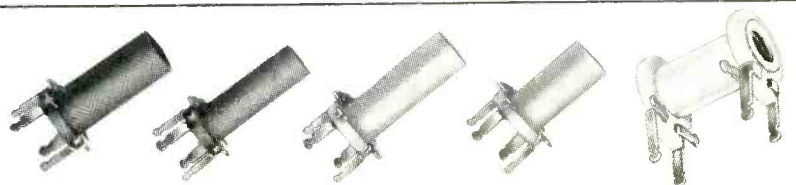

*for dependable service
under extreme conditions...*



Mallory Tantalum Capacitors

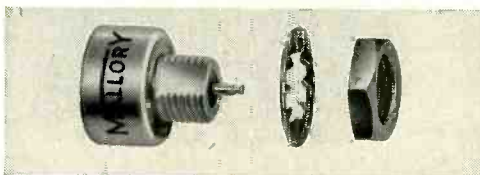

MILITARY AND INDUSTRIAL services require component dependability under extreme conditions of temperature and shock. Mallory research and production made possible the Mallory XT line of tantalum capacitors, now thoroughly performance tested and proven for this kind of service.

Mallory XT capacitors were the *first* made to withstand vibration shock to 2000 cps., and temperatures to 175° C. (the highest standard rating). On special order Mallory XT capacitors can be furnished for continuous duty at 200° C.

Mallory tantalum capacitors were *first* to employ a true hermetic seal—metal to glass—without use of rubber or synthetic materials, and are absolutely impervious to immersion. Only Mallory makes available such a broad range of capacity and voltage ratings.

Complete information on Mallory XT capacitors can be had by asking for a copy of the paper—"Typical Expected Performance Characteristics of Extreme Temperature Range Tantalum Capacitors." Data on subminiature capacitors, including the newest tantalum type, can be had by requesting technical bulletins on Mallory types TAP, TAW and TNT.

Write, or ask the Mallory representative.

Serving Industry with These Products:

Electromechanical—Resistors • Switches • Tuning Devices • Vibrators
Electrochemical—Capacitors • Mercury and Zinc-Carbon Batteries
Metallurgical—Contacts • Special Metals • Welding Materials

Parts distributors in all major cities stock Mallory standard components for your convenience.



CROSS TALK

► **WHO'S THE BOSS?** . . . "If the Russians agreed to permit aerial inspection but insisted that it be in full swing within a year we might not be able to put up the necessary equipment. Or, if we could, it might be very inefficient equipment indeed."

So says a prominent manufacturer of aerial reconnaissance apparatus, and thus points up a situation which concerns most manufacturers of electronic equipment and the military as well—the extreme difficulty of getting together on quantity production which meets the needs of both.

The industry says it can't finance, design, buy materials and components and deliver finished equipment complete with maintenance manuals on schedule if the military persists in doling out orders in mere sample quantities, changes the specs every odd Wednesday and then fools around with payment for the merchandise. The military says it can't store huge quantities of gear, has to make changes to keep pace with possible technical advances elsewhere and must safeguard the interests of the taxpayer by carefully checking bills.

Both are probably right; there has to be much give-and-take between industry and government in a democracy at peace. But there is one thing we think can and should be corrected. It should be possible

for a manufacturer who already has what he thinks is a firm order to get straight answers when he needs them without having to ring doorbells all the way up to the Secretary of Defense. And we know of many instances where there have been literally dozens of men in between, presumably with authority, who wouldn't say either yes or no. Or, if they did, were later reversed.

► **PREVIEW** . . . IRE's annual show in New York has always been good but it will be still better this year, if for no other reason than that the new Coliseum is a dream for exhibits.

Saw the boat show there just recently (and parted with a few bucks for a little day-sailer called

a "Thistle") and the facilities are just about perfect. The place will take our kind of a crowd with ease.

► **ASK THE CUSTOMER** . . . Whenever it seems that nothing new can be added to electronic consumer goods that will stimulate demand just ask any intelligent user who will hold still for questions.

We squeezed just one the other day and here's what he said: "How about doing something with portable radios so I don't have to aim the things or their antennas like a gun? Can't someone make a tv set with a station selector that moves without subjecting me to the danger of a sprained wrist? Has anybody thought about combining one of those little transistor radios with a hearing aid?"

LOOKING AHEAD . . .

Revolution in photo-engraving business is now not far away; more direct methods of converting art into cuts are coming fast

Electronic typesetting is also making progress, but will remain longer in the experimental stage

Photographic reconnaissance is nearing its altitude limit; there are heights above which intervening atmosphere distorts pictures despite excellent lens systems

High-speed light modulator in which refractive index of water column is varied at ultrasonic rate may provide new kind of radar photography

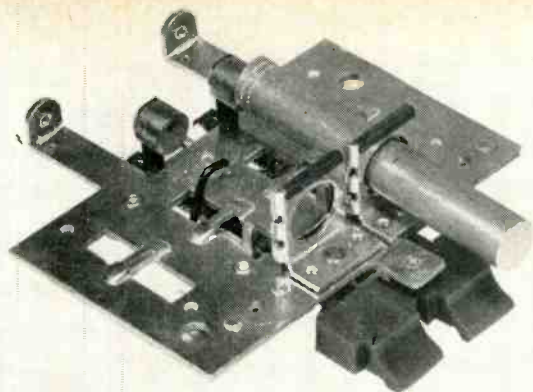

Complete two-channel transmitter, showing grille for ultrasonic output, and mounting details of aluminum rod, steel hammer and bent plastic-covered wire used as damper to terminate vibration of rod when pushbutton is released

ULTRASONIC GONG

By ROBERT ADLER, PETER DESMARES and JOHN SPRACKLEN

Research Department
Zenith Radio Corp.
Chicago, Ill.

THE ACOUSTIC signaling method of operating television receiver controls remotely insures that signals are confined by walls, so that all receivers can be built alike. Multiple control functions are easily accommodated by the use of several frequencies. Most important, acoustic signals can be produced mechanically, eliminating the need for a battery or other power reservoir in the transmitter.

Although an acoustic signaling system could be made to operate with signals in the audible range, it is questionable whether a system using fairly loud audible sounds would be acceptable to the public. The use of acoustic signals in the ultrasonic range avoids these difficulties without sacrificing the advantages of acoustic signaling.

Choice of Frequency

At ultrasonic frequencies, absorption in air produces losses in addition to the inverse-square-law attenuation which exists at all frequencies. Absorption loss varies with temperature and humidity and increases rapidly with frequency. For example, at 80 F and 37-percent relative humidity, absorption loss is 0.2, 0.5 and 0.9 db per foot for 20, 40 and 80 kc respectively. Thus, at 40 kc the absorption loss for a 30-foot distance is

15 db under these conditions. Absorption loss sets an upper limit to the range of useable frequencies.

A cylindrical aluminum rod, vibrating in its fundamental longitudinal mode, is a simple and effi-

cient source of ultrasound in air. If such a rod is struck at one end by a hammer moving along its axis, it emits a long-sustained note of well-defined frequency. For example, a rod $2\frac{1}{2}$ in. long and $\frac{3}{8}$ in. in diameter has a fundamental resonant frequency of about 40 kc; its vibration decays as in Fig. 1. The time constant is 0.23 second, corresponding to a Q of about 29,000. The internal damping of aluminum is so small that a large part of the vibrational energy stored in the rod by the impact is radiated.

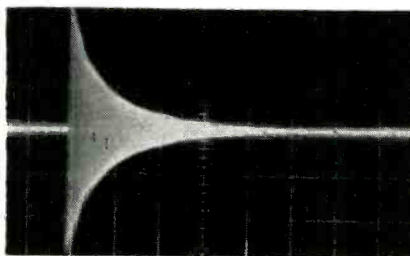

FIG. 1—Undamped output of aluminum gong decays in less than 1 sec. Each division horizontally represents 0.2 sec

Discrimination

With a signal of so sharply defined frequency, it would seem best to build a highly selective receiver and discriminate against undesired signals on the basis of frequency alone. This is not practical, however, because the resonant frequency of an aluminum rod decreases substantially with increasing temperature. At 40 kc this decrease equals 5.5 cps per degree F. Since receiver and transmitter will not always be accurately at the same temperature, compensation is only partly possible and receiver selectivity would have to be reduced considerably.

Special alloys could be used in place of aluminum to provide transmitter frequencies which are not

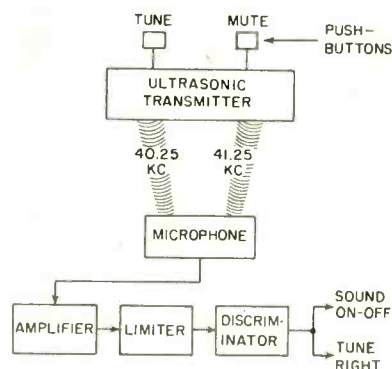

FIG. 2—Two-channel ultrasonic control system. Single tune button steps tuner switch in one direction only, hence button must be pushed 11 times to get next lower vhf channel

SUMMARY — Aluminum rods struck with pushbutton-actuated hammers generate slowly decaying single-frequency signals of four different values in vicinity of 40 kc. Electrostatic microphone in receiver acts with special control circuit to operate relays that turn set on, mute sound or tune in either direction. Frequency tripling, limiting, frequency selection and integration provide discrimination against jingling of keys and other acoustic interference. Simpler two-button version has only tune and mute control channels

CONTROLS TV SETS

affected by temperature, but another factor must be considered—the wide range of amplitudes, of signals as well as interference, to which the receiver will be subjected. Under practical conditions direct line of sight from transmitter to receiver does not always exist. The sound may arrive at the receiver by an indirect path which includes several reflections.

Standing-wave patterns arise which often reduce the received signal. On the other hand, strong ultrasonic interference is generated by any impact between small pieces of metal; jingling coins, rattling keys or opening a cigarette lighter produces surprising amplitudes in the ultrasonic range and this interference may be generated close to the receiver.

Receiving System

Figure 2 shows a receiving system which is well adapted to the interference situation in homes. The receiver consists of a microphone, a high-gain amplifier, a limiter and a discriminator. The discriminator circuit is so constructed that positive and negative voltages of equal magnitude appear simultaneously on two separate out-

put terminals. The control circuits are connected to these output terminals through integrating networks. Figure 3 shows the voltages at the two discriminator outputs as a function of input frequency.

This receiver is similar to a conventional f-m receiver, capable of accommodating a wide range of input levels. The voltages plotted in Fig. 3 are quite independent of the input level as long as it exceeds the minimum required to saturate the limiter.

Two transmitter frequencies cooperate with the single discriminator. Each frequency corresponds to one of the two output voltage peaks. It is thus impossible for any interfering signal to generate a larger discriminator output than that

which is produced by the transmitter, no matter how strong the interfering signal may be at the microphone. The control circuits are arranged to operate only if the discriminator output voltage exceeds a predetermined threshold, indicated in Fig. 3, for a certain minimum period of time; this period is defined by the time constant of the integrating network. To be mistaken for the desired signal, an interfering signal must have a frequency within the narrow band over which the discriminator curve exceeds the threshold (about ± 250 cps out of 40 kc), must last long enough to be accepted by the integrating network and must not be accompanied by other frequencies which would fall near the second

FIG. 3—Discriminator output voltages for two-channel system. Center frequency is 40.75 kc. Horizontal scale is 800 cps per division. Dashed lines indicate relay operating thresholds for sound on-off (upper curve, for 40.25-kc channel) and for tuning motor (lower curve, for 41.25-kc channel)

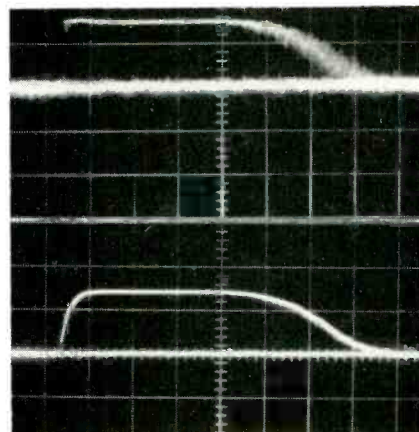
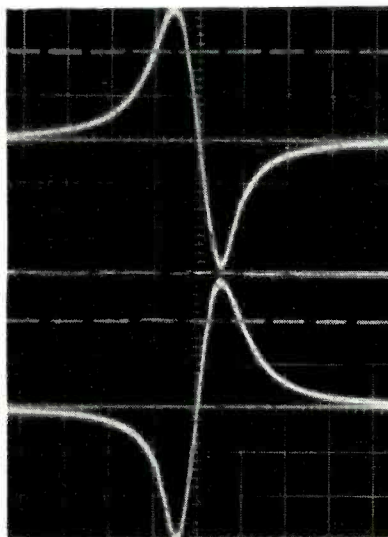

FIG. 4—Output voltage at one discriminator terminal before (above) and after integration. Horizontal scale is 800 cps per division from 40.75-kc center scale

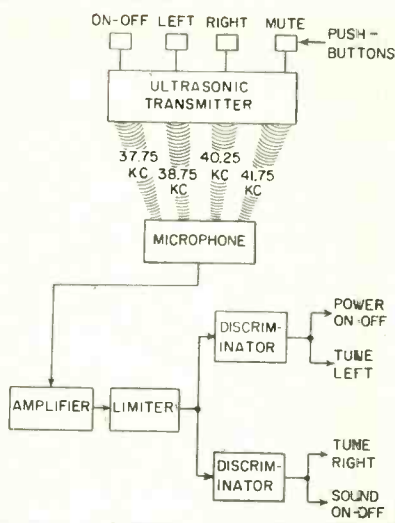

FIG. 5—Four-channel control system. Two tuning buttons permit going direct to desired new station

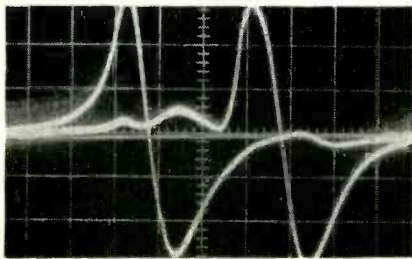

FIG. 6—Discriminator output voltages for four-channel system, where both discriminators operate from common limiter. Crossover for first curve is at 38.25 kc; second curve drops to zero at 40.75 kc

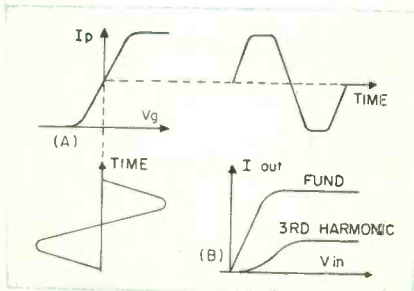

FIG. 7—Limiting and frequency-tripling actions of two-channel receiver

discriminator peak. This last-mentioned property makes the receiver insensitive to hiss and other broad-spectrum noises.

Integrating Action

Figure 4 illustrates the output voltage at one of the discriminator terminals, before and after integration, when a desired signal is received. The unintegrated output rises abruptly to the full level allowed by the limiter, remains at that level until the input signal be-

gins to drop below limiting and then gradually returns to the zero level. Random noise and acoustic noise combine to produce a fluctuating zero line. The integrating network cleans up the fluctuations and changes the abrupt step at the beginning to a gradual rise. These curves were photographed with the transmitter only a few feet from the receiver; limiting under these conditions lasts longer than one second. When the transmitter is moved farther and farther away, the curves of Fig. 4 do not go down in amplitude but merely last for shorter periods until, at the extreme distance, the integrating network prevents the lower curve from reaching the threshold and the control circuits cease to operate.

Interference, such as that produced by jangling keys, consists of closely spaced pulses of many different frequencies. In the presence of such interference, unintegrated discriminator output varies rapidly with time, showing a jagged curve which may include peaks of both polarities reaching or approaching the maximum level.

After integration, however, very little output signal is left because no single frequency is maintained long enough.

Four-Function System

In some television receivers, more than two remote control functions are needed. Figure 5 shows how four functions are provided by a remote-control receiver which has two separate discriminators; the microphone, amplifier and limiter are common to both. It is quite practical to operate two discriminator circuits from a single limiter tube by connecting their primary tuned circuits in series. The voltages developed in these circuits represent a substantial part of the available anode voltage, but the two discriminators never operate simultaneously, so that voltage overload effects are not a problem.

Undesired coupling between the two primary tuned circuits is introduced by the output capacitance of the limiter tube, but this can be neutralized by taking advantage of a small controlled amount of inductive coupling between the two coils

in the two tuned circuits.

Figure 6 shows the output voltages observed on the two discriminators. A disturbance appears in the response curve of each discriminator in the vicinity of the center frequency of the other discriminator, but the disturbances are far below the threshold and therefore of no significance.

The control circuits employ relays which are operated by the plate current of triodes. A large negative bias is applied to the grid of these triodes to define the threshold which the discriminator output voltage must exceed. To render the control circuits fairly independent of the triode characteristics, bias voltages of the order of 20 volts and discriminator peak outputs of about 30 volts are used. To obtain output of both polarities, a center tap on each discriminator load resistor is returned to the source of bias voltage, so that a total discriminator output of about 60 volts is required. To insure operation even under highly unfavorable circumstances, limiting should occur with input signals of no more than $10 \mu\text{v}$, considering the sensitivity of the microphone employed. A voltage gain of about 10^7 or 140 db is thus required.

To obtain a gain of 140 db at a single frequency would require rather expensive shielding and decoupling. This is avoided by using the limiter simultaneously as a frequency tripler. Figure 7A illustrates how this is done; the limiter tube (6BN6 or equivalent) has a transfer characteristic which resembles a step function. A sufficiently large input signal produces an anode current of substantially square waveform.

Frequency Tripling

In Fig. 7B, the amplitudes of the fundamental and of the third harmonic components of the anode current are plotted against input signal amplitude. To limit on the third harmonic requires a larger input signal and the limited output current is only one-third as large as the fundamental component, but even with these disadvantages tripling in the limiter remains quite practical. The simple receiver shown in Fig. 2, which employs only

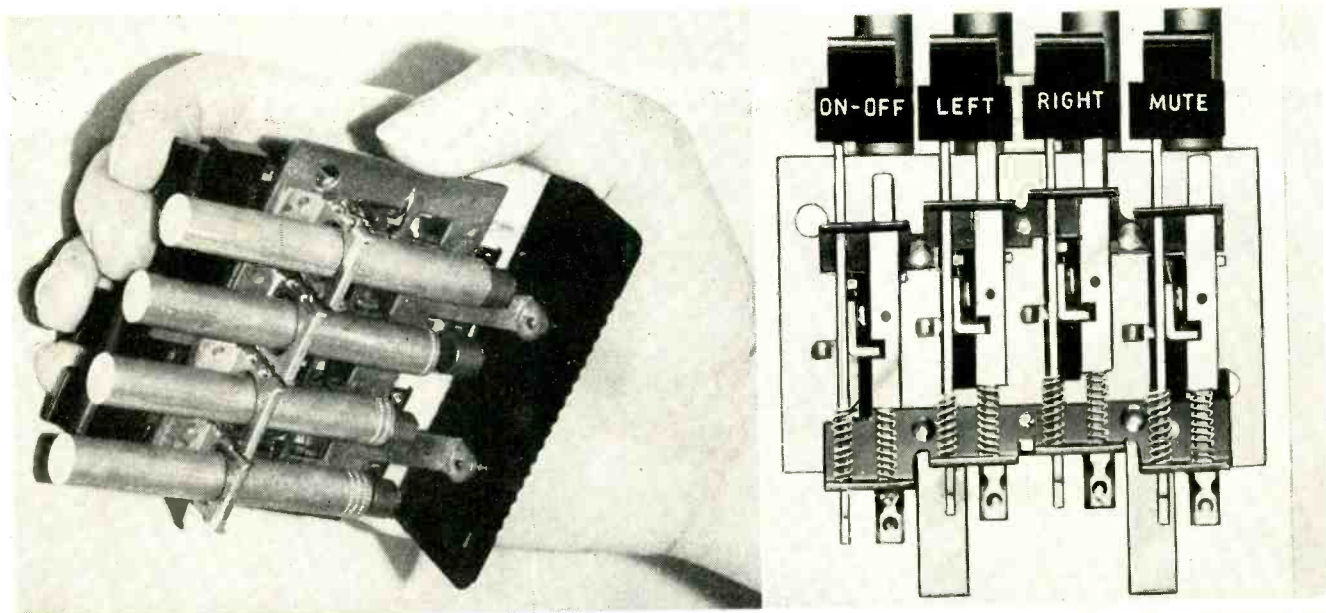

Opposite sides of four-channel transmitter. Pushing a button cocks steel hammer and then releases it to strike end of aluminum rod and produce ultrasound used for actuating microphone mounted above picture tube in receiver

one discriminator, uses this circuit.

In the more complex receiver illustrated in Fig. 5 it is desirable to keep the output impedance of the limiter tube as high as possible to avoid interaction between the two discriminators. Also, limiter anode current should be kept low to obtain close control over the discriminator output levels. This is more easily accomplished with a limiter in which the input and output frequencies are the same. For this reason, a separate triode tripler stage precedes the limiter in this receiver.

Frequency tripling not only reduces shielding requirements but also decreases the cost of the discriminator circuits. To obtain the output characteristics illustrated in Fig. 3 and 6, the tuned circuits in these discriminators must have Q 's of about 80 and must be stable with respect to temperature and aging. To accomplish this at 120 kc is much less expensive than to reach equal performance at 40 kc.

Complete Control Circuit

Figure 8 shows the circuit of a receiver for four control functions.

A tuned circuit in the second pentode plate insures good waveform at the input grid of the tripler triode. This operates with grid-leak bias at low anode voltage and produces about 1.5 v third harmonic output with 1.5 v of fundamental input. The following 6BN6 operates only as a limiter with relatively low anode current, feeding the two discriminators. The 6CM7 relay control tube for each discriminator contains two dissimilar triode sections; the larger section operates the sound-on-off relay, which requires more driving power than the



FIG. 8—Four-channel receiver circuit. Separate 2526 full-wave rectifier (not shown) provides power here, but two-channel version obtains power directly from television receiver in which it is used



Photograph of solar flare taken at Sacramento Peak Observatory, Sunspot, New Mexico. The solar flare ionizes the atmosphere, resulting in changes that are detected by two radio receivers

By **ROBERT H. LEE**

*High Altitude Observatory
Boulder, Colorado*

SOLAR-FLARE

SUMMARY — Two radio receivers, operating at 27 kc and 18 mc, intercept signal disturbances occurring in the D-layer of the ionosphere during a solar flare. The detection system indicates an increased signal caused by sudden lightning bursts and an attenuated signal caused by cosmic-noise absorption. Pulse analyzers discriminate against background noise, interfering radio stations and unwanted atmospheric disturbances. Signals are chart recorded on a time-sharing basis

WHEN a solar flare occurs, there is often a rapid increase in the radiation that ionizes our atmosphere, to form the ionosphere. This radiation is probably Lyman alpha (1,216 Angstroms), or some shorter wavelength. The effect is most commonly known as a sudden ionospheric disturbance or a sudden short-wave fadeout. A severe disturbance can cause a complete blackout of short-wave long-distance communication. This fading is caused by increased absorption of the radio waves as they pass through the D-region of the ionosphere at a height of about 80 kilometers.

Two distinct types of radio signals are used to detect and study

these solar-flare effects. The system is shown in Fig. 1.

The first receiver, operating near 27 kc, detects any important sudden enhancement of atmospheric and records the frequency and intensity of lightning bursts from various parts of the world. When a solar flare occurs, the reflecting ability of the D-region of the ionosphere on the sunlit side of the earth is improved suddenly and there is an increase in the strength of the received signals. The decay in signal strength is much slower, indicating the recovery of normal ionization in the D-region.

The second method of detection records galactic or cosmic radio noise coming to us from space. This

noise, in coming through the ionosphere, is partially absorbed. When a solar flare occurs, absorption is suddenly increased. This is called a sudden cosmic-noise absorption. The region around 18 mc is a reasonable compromise frequency for this measurement.

If a considerably higher frequency is used, the absorption becomes smaller and is difficult to measure. If a lower frequency is used, the interference from radio stations and atmospheric becomes more severe.

Noise-free locations are difficult to obtain and man, and considerable effort was spent in designing equipment that would discriminate against unwanted pulse signals.



Antenna array for solar-flare detection uses two parallel half-wave folded dipoles, spaced one half-wave apart and driven in phase

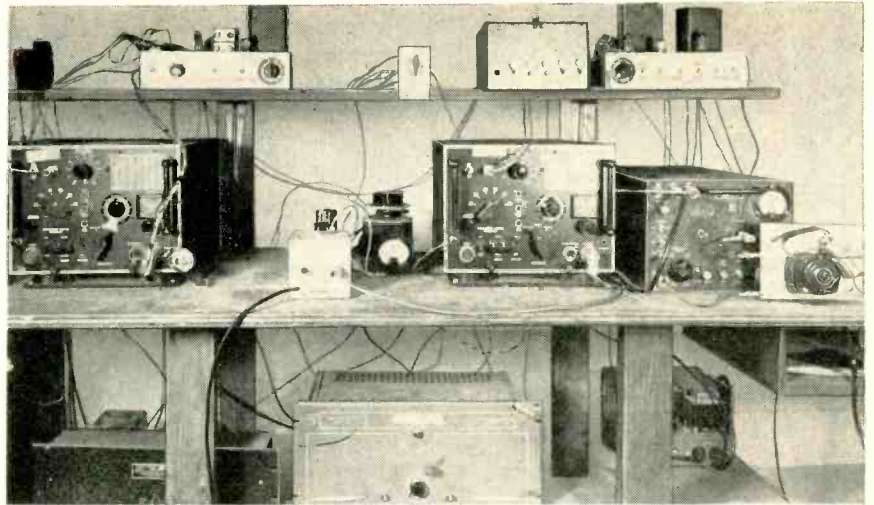

Solar flare detection equipment includes from left to right, a 27-kc receiver, noise calibrator, 18-mc receiver (second i-f), ARR-7 receiver (r-f and first i-f) and motor-driven radio frequency scanner. The two signal-interference rejectors are on top shelf, on both sides of timer. Chart recorder is not shown

DETECTION FOR IGY

The 27-kc receiver signal is caused by individual bursts of atmospheric noise due to thunderstorms. If the thunderstorm is sufficiently distant from the receiver that reception takes place by multiple reflections from the D-layer, the signal strength is increased at the time of a solar-flare. Also there is an extension of the

area over which signals are received.¹

At 27 kc, serious interference is created by power-leaks, brush-type electric motors and other electrical appliances. For this reason the receiver uses a shielded-loop antenna to null out main powerline noise. This receiver, the Navy model DZ-2, was designed as a direction finder

and is available complete with loop antenna.

An infinite-impedance detector was added to the receiver with the front end modified to permit the loop antenna to be used remotely.

Background Noise

In spite of the use of the loop antenna, there is still an appreciable amount of noise received. If an ordinary averaging circuit were used, the atmospherics would be lost in the low-level background.

Fortunately the atmospherics, though infrequent, are greater in amplitude than most of the peaks of the background hash after nulling the main source of powerline noise. This permits use of a base clipper to prevent the low-level signals from reaching the signal-integrating device. This clipper can be the same diode that permits the charge and discharge time constants of the integrating circuit to be different.

Noise Discrimination

An atmospheric burst encounters the circuit shown in Fig. 2. The burst from the infinite-impedance detector in the receiver appears as

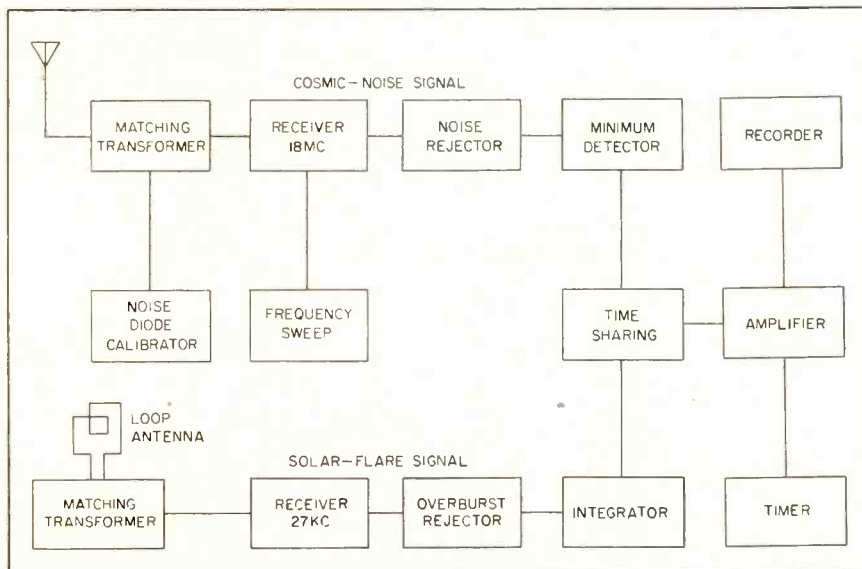

FIG. 1—Block diagram of solar flare and cosmic-noise detector

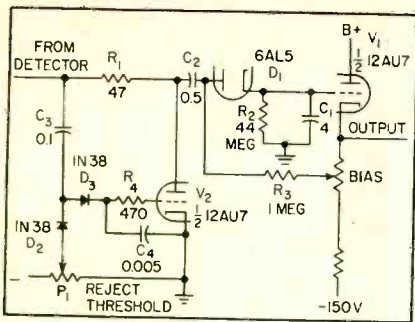

FIG. 2—Integrator and noise-rejection circuits in the 27-kc receiver

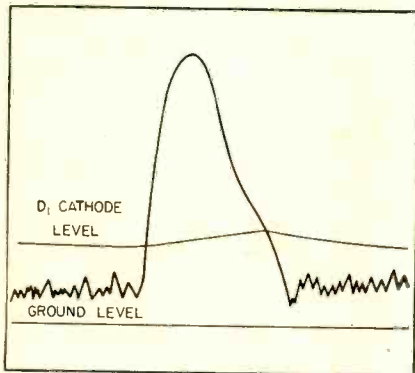

FIG. 3—Solar flare signal from the 27-kc receiver

a positive pulse as shown in Fig. 3. When the amplitude becomes great enough, D_1 conducts and the pulse charges C_1 through capacitor C_2 and limiting resistor R_1 . As the amplitude of the burst drops, D_1 opens and C_2 is charged through R_3 to a new level so that the diode bias is restored. Also the charge lost by C_2 during the charging of C_1 is restored. The system is now ready for the next burst to be received at some undetermined later time.

The voltage on capacitor C_1 reaches equilibrium at a value given by average of pulses above clip level $\times R_2/R_1$, assuming that C_2 can reach equilibrium between pulses.

Amplitude Selection

In addition to clipping out some of the base-level noise, it may be desirable to reject local thunderstorm bursts. This can be done by amplitude selection and is accomplished by V_2 in Fig. 2. In this application V_2 is biased beyond cut-off by the d-c restoring circuit C_3 , D_2 , P_1 .

If a positive burst of sufficient amplitude occurs, V_2 conducts, causing the burst to appear as a drop

across R_1 . The voltage waveform presented to the integrator then appears as in Fig. 4A.

The C_1 charging current waveform will be the same as that portion of the voltage waveform above the D_1 cathode level. Thus the system rejects bursts above the amplitude selected at P_1 , except for that part of the leading and trailing edges which are below the rejection level.

The trailing edge of an atmospheric burst has somewhat less slope than the leading edge, so most of the charge accumulated from a rejected burst comes from the trailing edge. The trailing edge can be eliminated by D_3 and C_4 . When a large burst comes from the receiver, C_4 is charged through D_3 to nearly the peak value of the burst. Then, as the burst drops off, D_3 opens, leaving C_4 to discharge through R_4 and the back-resistance of D_3 . By choosing capacitor C_4 properly, the voltage waveform presented to the integrator will be as shown in Fig. 4B. Only a small spike represented by the part of the curve above D_1 cathode level shows up as capacitor charge.

There will be smaller bursts present in a local thunderstorm against which the system cannot discriminate. Therefore, the best that can be hoped for is that there will be some discrimination against storms not in the immediate area, but too close to be received by D-layer reflection.

Cosmic-Noise Signal

The signal for the 18-mc receiver is galactic or cosmic radio noise generated in the galaxy. In coming through the ionosphere the noise

is attenuated, depending on the ionization present. When a solar flare occurs, the attenuation is increased.²

At approximately 18 mc, automobile ignition, power line noise and radio stations are the chief sources of interference. One cannot discriminate against background since this is what is to be measured.

Cosmic Signal Level

The rejection technique for ignition and power line noise is similar to that used with the 27-kc receiver to reject local thunderstorm bursts. However, the rejected noise burst must be reduced only to the average level. If it is reduced too far, it will cause a decrease in the recorded signal level and would be worse than no rejection at all, since we are looking for decreases. Reduction is accomplished by returning the cathode of the noise-rejection triode to a point which varies as the average noise level, rather than to ground as in the 27-kc rejector.

Radio Interference

The rejection circuitry just described, satisfactorily removes impulse-type interference from the receiver output. However, there remains the problem of interfering radio stations.

To overcome this interference, the tuning dial of the receiver is mechanically driven so that it sweeps back-and-forth over a range of about 30 kc. Radio station interference can be eliminated by the circuit shown in Fig. 5.

Capacitor C_1 is charged slowly in a positive direction through R_5 . When the potential reaches the volt-

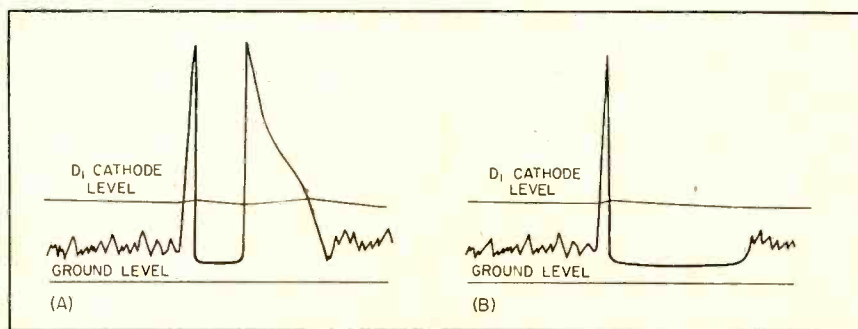

FIG. 4—Output of basic amplitude selector for rejected burst (A) and after pulse elimination (B)

age level of the cathode of V_2 , D_3 conducts and prevents the capacitor from charging further. If an interfering signal causes the cathode of V_2 to go positive, D_3 opens and C_4 starts to charge slowly.

As soon as the interference is gone, D_3 conducts and rapidly discharges C_4 down to a level determined by the background noise as averaged in R_8 , C_8 . If the charge rate of C_4 is slower than the sweep rate on the tuning dial, the recording will be nearly a straight line representing the base noise level, ignoring the interfering radio stations.

The receiver used in the experimental system is an ARR-7 working into a DZ-2 receiver, making it a double conversion superhet with i-f of 456 and 88 kc. The first r-f stage of the ARR-7 was changed from a 6SK7 to a 6AC7 to improve the noise figure.

Antenna

The antenna array consists of two horizontal, parallel half-wave folded dipoles, spaced one half-wave apart and driven in phase. The dipoles are placed one-tenth wavelength above a ground screen.

The vertical gain of the antenna is useful primarily as a means of discriminating against interfering signals arriving at low angles above the horizon.

Chart Recorder

The present method of recording uses a pen recorder utilizing a time sharing system to record the output of both receivers on the same chart. A chart recording of a solar flare is shown in Figure 6. The 18-mc receiver output has its zero point toward the bottom of the chart. Increasing signal level moves the pen upward. The 27-kc record has its zero at about the center of the chart. Increasing signal level causes the pen to move upward. At the time of a flare, the sudden cosmic noise absorption recording line deviates toward the lower part of the chart and the sudden enhancement of atmospherics record moves toward the top.

Interference on the 27-kc record goes in the same direction as the flare-signal record. For the 18-mc

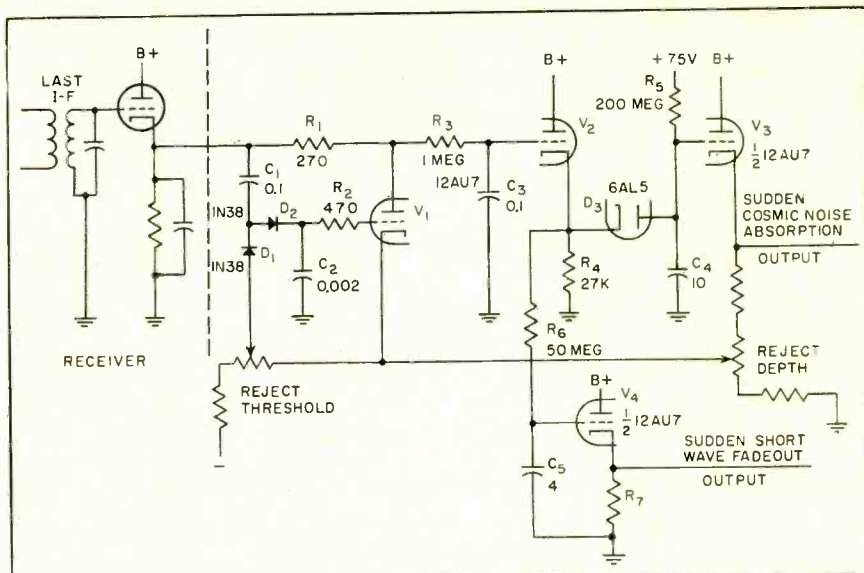

FIG. 5—Radio-interference retractor for the 18-mc receiver

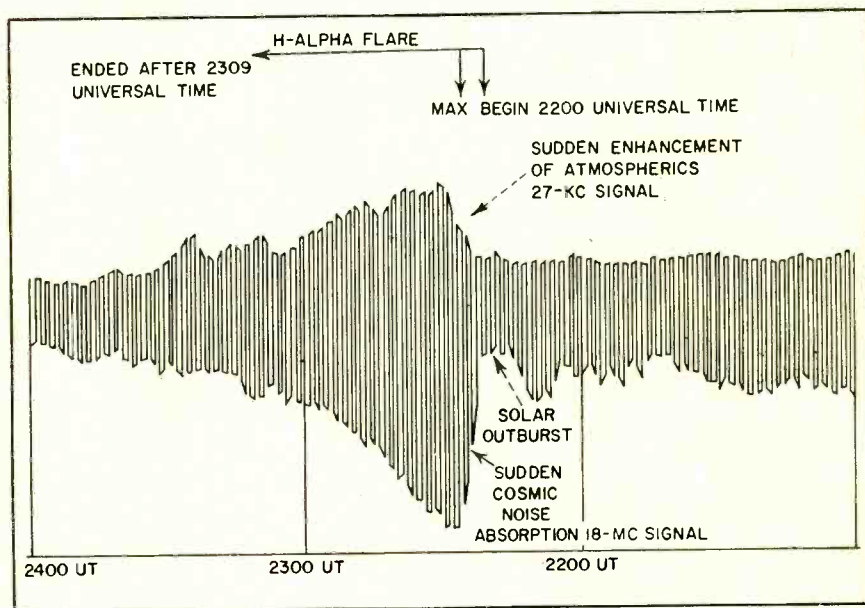

FIG. 6—Chart recording of solar flare shown in photograph. The two signed traces are recorded in universal time

record the interference goes in the opposite direction from the cosmic-noise signal.

Sudden short-wave fadeouts may be recorded by connecting an RC averaging circuit, time constant of 3 or 4 minutes, to the cathode of V_2 in Fig. 5. This averaging circuit is then isolated by a cathode follower.

Three of the finished units will be in operation during the International Geophysical Year 1957-58, at the High Altitude Observatory, Boulder, Colo., at Sacramento Peak Observatory, Sunspot, New Mexico and at McMath-Hulbert Observatory at Lake Angelus, Mich.

The work described here was supported by the National Committee for the International Geophysical Year 1957-58, through a National Science Foundation grant. The author wishes also to express appreciation to William Wright of High Altitude Observatory for his assistance in construction and testing of this equipment.

REFERENCES

- (1) M. A. Ellison, The H-alpha Radiation from Solar Flares in Relation to Sudden Enhancements of Atmospherics on Frequencies Near 27 kc. *J. of Atmospheric & Terrestrial Phys.*, 4, p 226, 1953.
- (2) C. A. Shain and A. P. Mitra, Effects of Solar Flares on the Absorption of 18.3-mc Cosmic Noise. *J. of Atmospheric & Terrestrial Phys.*, 5, p 316, 1954.

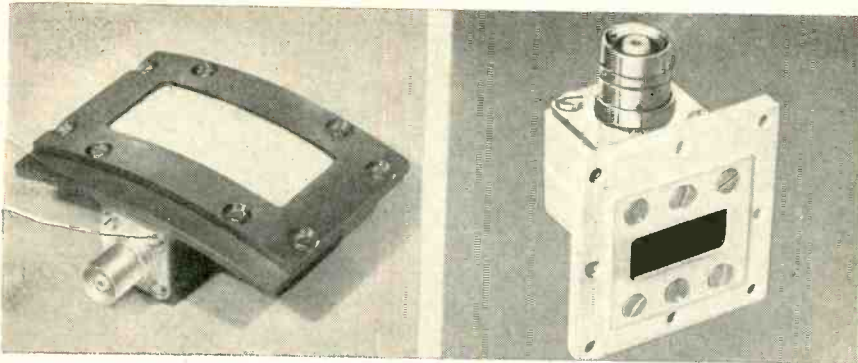

Assembled missile beacon antenna elements for S-band (left) and X-band (right) frequencies. Similar slot elements with different curvatures and matching sections accommodate different missile diameters

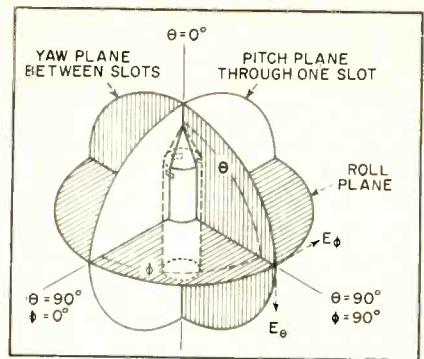

FIG. 1—Radiation pattern coordinate system for missiles. Antenna array of three elements gives best pattern coverage

BEACON ANTENNAS

IMPEDANCE matching and radiation patterns of a single-slot antenna were made on a large, flat ground plane and on a 15-inch diameter, 3-foot long cylinder. Configuration selected for the S-band system was a T-fed slot whose overall mounting depth was less than 1½-inches.¹ The exciting element consisted of a 0.165-inch diameter stub which is a continuation of the center conductor of the feed section into the cavity.

The X-band antenna is similar to the S-band antenna except that the

shunt bar is eliminated leaving a stub-excited slot element. The feed stub was machined from coin silver rod and press fitted to a UG-568/U receptacle.

Radiation Patterns

A radiation pattern coordinate system for missiles is shown in Fig. 1. Calculations and measurements of radiation pattern substantiated previous results.

As shown in Fig. 2, the magnitude of the field at point *P* due to the contributions of antenna ele-

ments 1, 2 and 3 may be computed from the measured radiation pattern of a single element using the following steps:

(1) Plot measured patterns of single antenna on cylinder using polar reference angles at $\phi = 0, 120$ and 240 degrees.

(2) At each interval of ϕ record magnitude of field for each antenna element E_1, E_2 and E_3 .

(3) Add E_1, E_2 and E_3 vectorially.

$$E_t = E_1 + E_2 \angle B_1 + E_3 \angle B_2$$

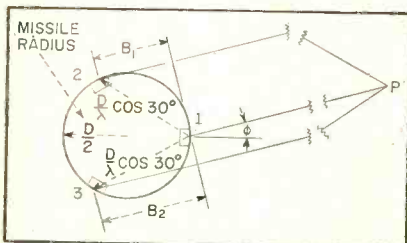
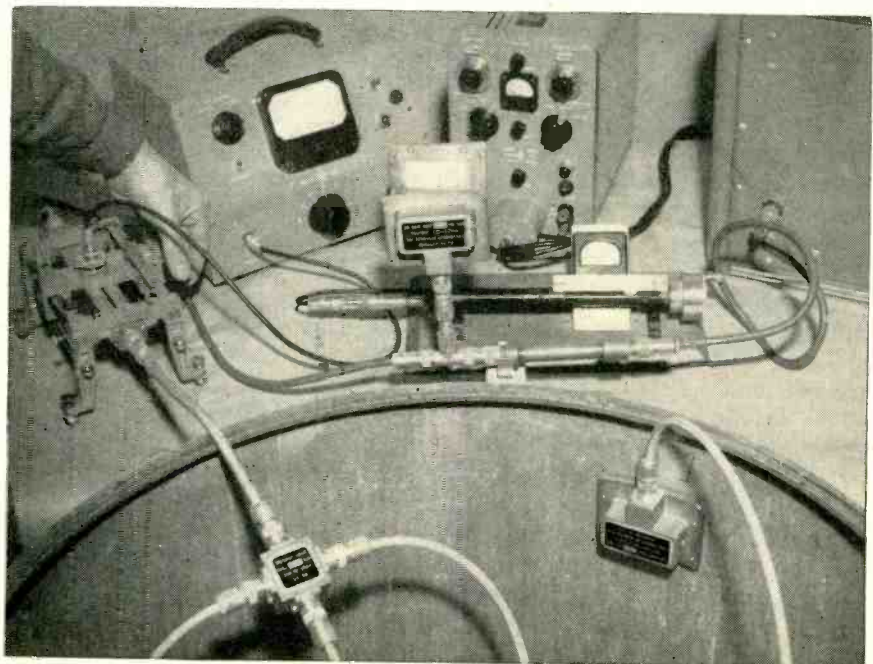

FIG. 2—Magnitude of the field at point *P* is computed from measured radiation patterns of a single element

Matching line transformer, at upper right of photograph, feeds power to a four-sided feed block. The power is divided to the three antenna elements and impedance is matched at the junction of the feed block



SUMMARY — S-band and X-band antenna arrays consisting of three elements, equally spaced and circumferentially mounted on the missile, are fed in phase with polarization parallel to the missile axis. Radiation patterns for missile diameters ranging from four to 48 inches show better coverage and fewer small nulls than patterns of any other array up to and including 12 elements. Calculations, measurements of radiation patterns and techniques for impedance matching are given to assure best reception from or transmission to a circularly-polarized earth-mounted antenna

By **W. E. BARRICK*** and **D. L. BRANNON†**

*Electronics Research, Inc.
Evansville, Indiana*

For Guided Missiles

Where $\angle B_1 = \frac{D}{\lambda} \cos 30 \sin(60 - \phi)$

and $\angle B_2 = \frac{D}{\lambda} \cos 30 \sin(60 + \phi)$

(4) Plot magnitude of E_r obtained from Step 3 for each interval of ϕ used in Step 2.

Roll-plane patterns of multi-slot S-band arrays, plotted in Fig. 3, indicate that additional slots in excess of three merely increases the number and severity of the nulls present and pancakes the pattern. Calculations, plotted in Fig. 4, indicate that circumferential mounting, gives very superior coverage in the roll plane as compared to axially-mounted slots.

The principal plane patterns of a 3-slot S-band array have nulls in all three planes for the principal polarization which are covered by at least some cross polarization and the nulls fore and aft in the pitch and yaw planes are very sharp. However these sectors of possible circular polarization are small since the field patterns for both polarizations are changing rapidly, thus making the spherical coverage consist largely of linear polarization.

In these sectors there is an equal probability that the circularity of polarization will be of the correct

sense suitable for reception from or transmission to a circularly-polarized earth-mounted antenna system.

The array of three elements gives the best pattern coverage on all sizes through 48-inches diameter. A two-slot array, circumferentially mounted, was used on the 4-inch diameter missile.

Optimum antenna cavity dimensions and diameter of exciting stub and shunt bars were determined by

impedance measurements on a single-slot element. Temperature requirements narrowed the choice of slot cover materials to the ceramics family and Alsimag 35 was selected for the cover. High-temperature polyester-bonded fiberglass covers could be used as an alternate material for 500 F maximum temperature requirement. The impedance of the single-slot antenna with a $\frac{1}{8}$ inch thick ceramic cover is approximately 17 ohms resistive

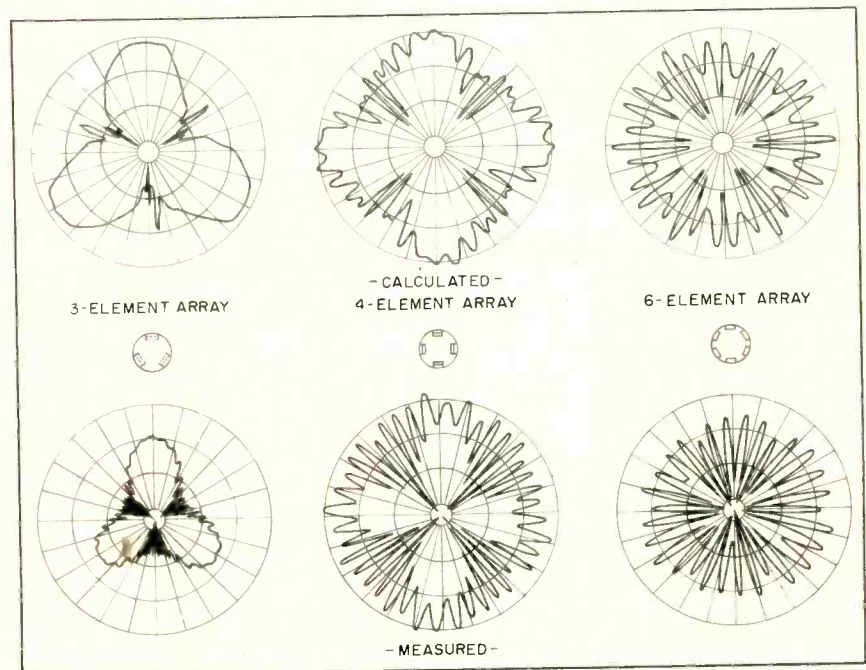
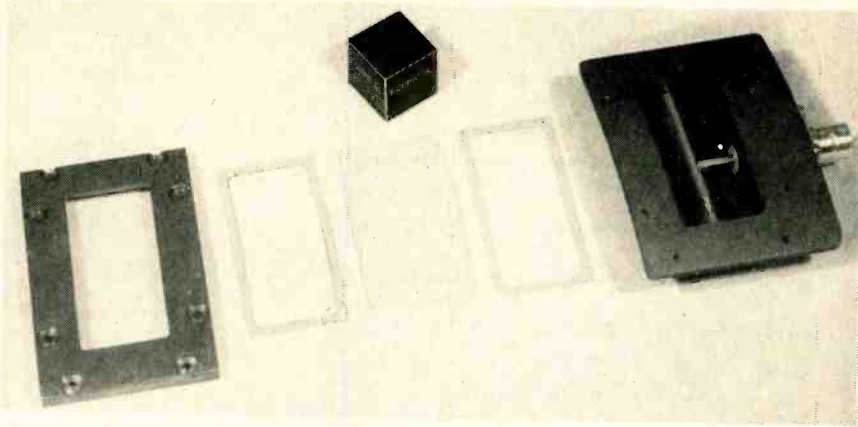

FIG. 3—These roll-plane patterns for 40-inch diameter missile show that S-band antenna elements in excess of three increase the number and severity of nulls

* Now with Cook Research Laboratories, Skokie, Ill.
† Now with Westinghouse Air Arm Division, Baltimore, Md.



Relative size of an S-band antenna element compared to a one-cubic-inch block. The T-fed slot is covered with Alsimag 35 ceramic window

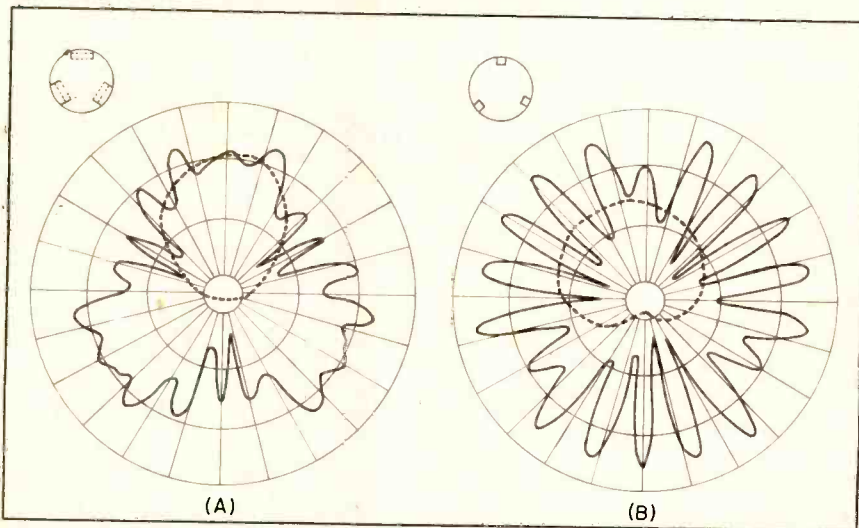

FIG. 4—Calculated roll-plane patterns for 15-inch diameter missile indicate that circumferentially mounted slot elements (A) give very superior coverage in roll plane as compared to axial mounting (B)

and with a $\frac{1}{16}$ inch thick cover approximately 23 ohms resistive.

The definition circle for 1.8:1 vswr on the impedance plots is drawn for the frequency band 2,835 mc to 2,965 mc and the circle for

1.2:1 vswr is drawn for the band 2,892 mc to 2,922 mc.

A matching line transformer, consisting of a 27-ohm coaxial line approximately 0.21 in length, feeds power to a four-sided feed block

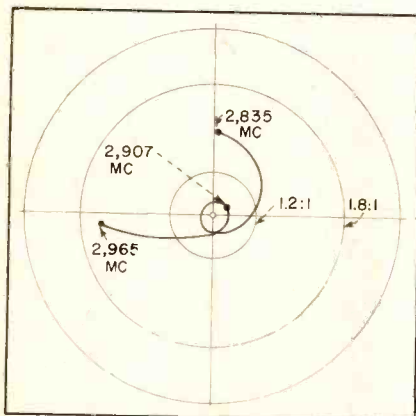

FIG. 5—Impedance plot of three S-band antenna elements on 15-inch diameter missile with 27-ohm line transformer approximately 0.21-inch long incorporated inside feed block

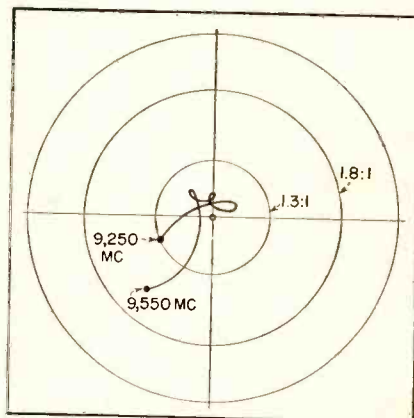

FIG. 6—Impedance plot of three X-band antenna elements mounted on 15-inch diameter missile was obtained by optimizing the overall diameter and length of the stub excited slot elements

which consists of three short 50-ohm sections. The power is divided to the three antenna elements and impedance is matched at the junction of the feed block. All interconnecting cable lengths are accurately maintained for proper power distribution. Fig. 5 shows a typical impedance plot for a 15-inch diameter missile.

X-Band Impedance

Very little success was realized using line-transformer methods to match impedance. Difficulty was encountered in controlling the degree of transforming action and the close tolerances required were impractical for production. Difficulty was also experienced with the fringe capacity introduced by a step-up or step-down in diameter of transformer center conductor and stub at the entrance to the cavity. By eliminating this step-up or step-down in diameter and optimizing the stub over-all diameter and length, a matched condition was obtained over the required bandwidth. The impedance plot is shown in Fig. 6.

The antenna array system is adaptable to waveguide feed by attaching a waveguide-to-coaxial adaptor, constructed from a short section of RG-52/U waveguide, a UG-40A/U waveguide, a UG-568/U receptacle with press fitted probe and a receptacle block.

Since the S-band and X-band beacon-antenna systems bracket C-band, it is comparatively simple to extrapolate an antenna system design for the C-band frequency.

Development of those systems was sponsored by the U. S. Army Signal Corps Engineering Laboratories, Ft. Monmouth, New Jersey under contracts DA-36-039 SC-52,611 and DA-36-039 SC-15,522.

Thanks are due the Signal Corps for permission to publish this material and to B. H. Baldrige, Engineer Supervisor of Electronics Research, Inc. for his guidance and assistance.

REFERENCES

- (1) R. R. L. Staff, "Very High Frequency Techniques", 1, p. 138, McGraw-Hill Book Co., Inc., New York, 1947.
- (2) Antenna Research Laboratory, Inc., Final Report on Antenna for S-Band Beacon on Aerobee Missile.



Color equipment can be adjusted by operator at control console

MONOCHROME SLIDES BROADCAST COLOR

By EDWARD L. COVINGTON

Engineering Dept.
KVOO-TV
Tulsa, Oklahoma

SUMMARY — Two complementary colors can be broadcast from a tv transmitter using monochrome slides having well-defined transitions. In addition, special circuits permit continuous transmission of a yellow-green color stripe for color receiver adjustment during monochrome broadcasts

WITH increased numbers of color tv receivers being installed and only occasional color programs on the air during convenient servicing times, a system is desirable for providing a continuous color test signal. A narrow strip of color on the extreme edge of the picture permits proper receiver adjustments during monochrome transmissions.

A system permitting use of monochrome slides to produce color reduces the cost of programming. A station backlog of slides thus becomes useful for color work. The system to be described satisfies both of the above requirements. The equipment is divided into two rack-mounted units referred to as the subust generator and the bicolorimiter.

Broadcasts of either of the above signals require a standard color

subcarrier reference burst. The subcarrier signal and burst keying pulses are generated by conventional circuits. The subust generator produces the color stripe signal. To create the stripe, the burst timing pulse is delayed by approximately $3.5 \mu\text{sec}$ as shown in Fig. 1.

It then triggers the stripe keying stages to produce a signal identical to and in phase with the reference burst, but delayed by the amount of DL_1 . This signal is combined with burst in the adder stage to produce the waveform shown in Fig. 2.

When the burst-stripe signal is added to the televised picture, the stripe appears on the extreme left edge as a narrow vertical bar, yellow-green in color. It can be seen by slightly reducing the width of the receiver raster. Normal width adjustment prevents the stripe from being objectionable during

normal viewing, because it is masked by the sides of the screen.

Bicolorimiter

The bicolorimiter provides for the addition of two-color information to the monochrome slide signal. As is evident from Fig. 3, colors opposite each other on the NTSC vector diagram are complementary. It is therefore practical to split the phase of the subcarrier and produce color combinations that are pleasing to the eye.

The schematic diagram Fig. 4 shows that two delay lines are used, DL_1 delays the luminance information to coincide with the chrominance signal at the mixing point. Tapped along its length, DL_2 provides a selection of subcarrier phase with reference to burst.

These delay lines, originally developed by the KVOO engineering

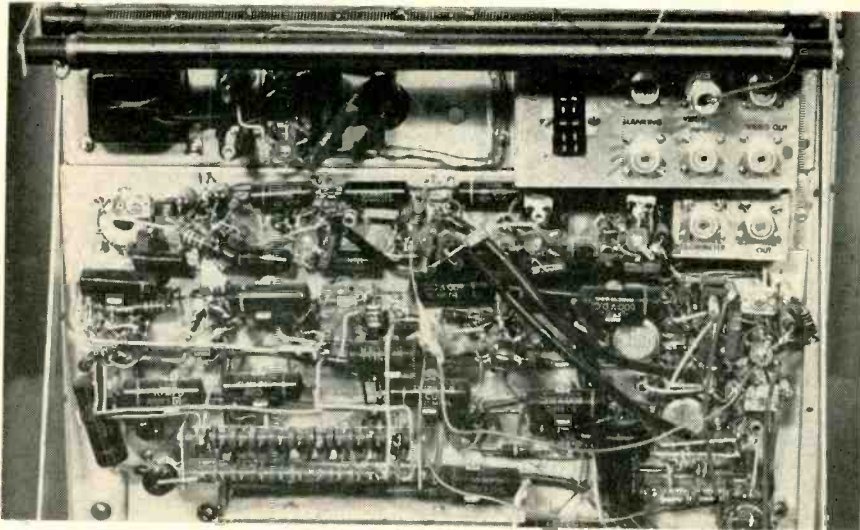

Rear view of color supplement chassis reveals construction of various delay lines

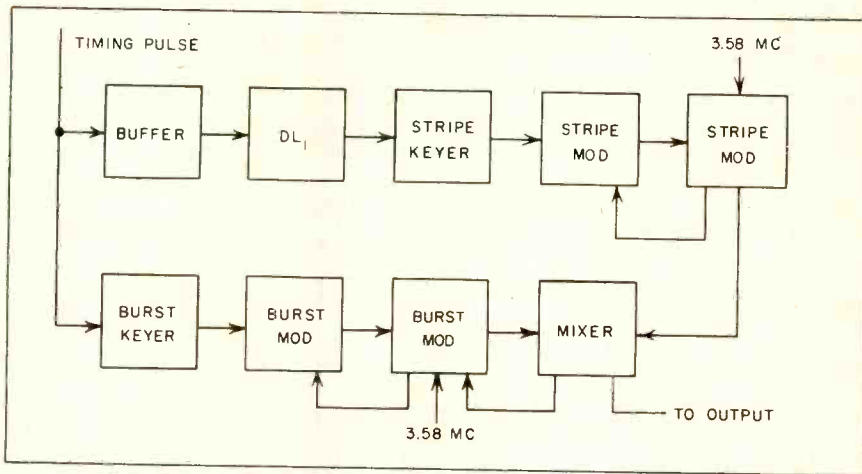

FIG. 1—Block diagram shows how the stripe and burst-forming stages are connected

department for another purpose introduce up to one-microsecond delay with acceptable video bandwidth. They consist of 200 turns of number 18 double Formex insulated copper wire wound in a spiral groove machined in a $\frac{3}{4}$ -in. copper tube form. The wire spiral produces inductance and the proximity of the wire to the copper form provides the capacitance for this distributed-constant type delay line.

Increasing Capacitance

The cutting tool used to machine the spiral groove was specially ground to make a round bottom increasing the capacitance between the wire and the form. The form is slotted lengthwise to prevent a shorted-turn effect. This slot makes it convenient to tap the line at the desired delay point.

Since the characteristic impedance is inversely proportional to the square root of the shunt capacitance ($Z_0 \propto \sqrt{L/C}$) a convenient method of lowering the impedance to the desired 75 ohms is to increase the distributed ca-

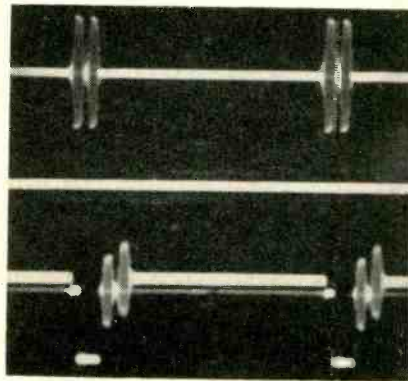

FIG. 2—Burst-stripe mixer output (above) and burst-stripe added to monochrome video (below) shown on an oscilloscope

pacitance by the application of printed circuit type silver paint in strips along the length of the delay line form.

After the correct impedance is established, the line is given a protective coating of Glyptal. The particular lines have been in use, in various experimental circuits, for six years and appear to be rugged and stable in this type of application.

Pulse Circuits

Video, preferably from an automatic level-setting device, is applied to the grid of video amplifier V_1 . The amplitude is further increased by V_2 to the point of some compression. This permits sharp clipping of the signal by V_3 , which was selected for its narrow cutoff-to-saturation characteristic.

The output of V_3 becomes a keying pulse that is amplified by V_4 and applied to phase inverter V_5 . Pulses at the output of V_5 , which are 180 deg out of phase, are applied to the suppressor grids of V_6 and V_{10} to cause them to alternate between conduction and a cutoff condition.

From the output of V_4 , the pulse is also applied to an output stage to be used for montage purposes, increasing the scope of the station special-effects keying amplifier.

Subcarrier Circuits

The 3.58-mc c-w subcarrier from the subgenerator is applied to the input end of DL_2 . Taps permit color selection since the subcarrier phase is dependent on the distance from the input end of the line. The signal is then applied to the con-

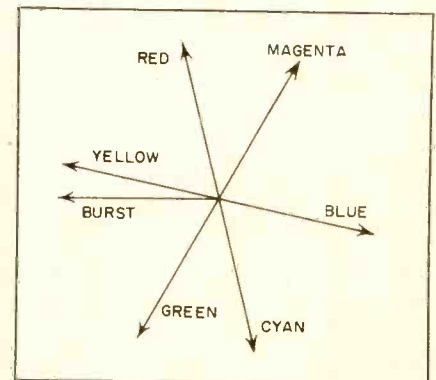

FIG. 3—Vector diagram relates colors showing complementaries at 180 degrees making the device usable for slides

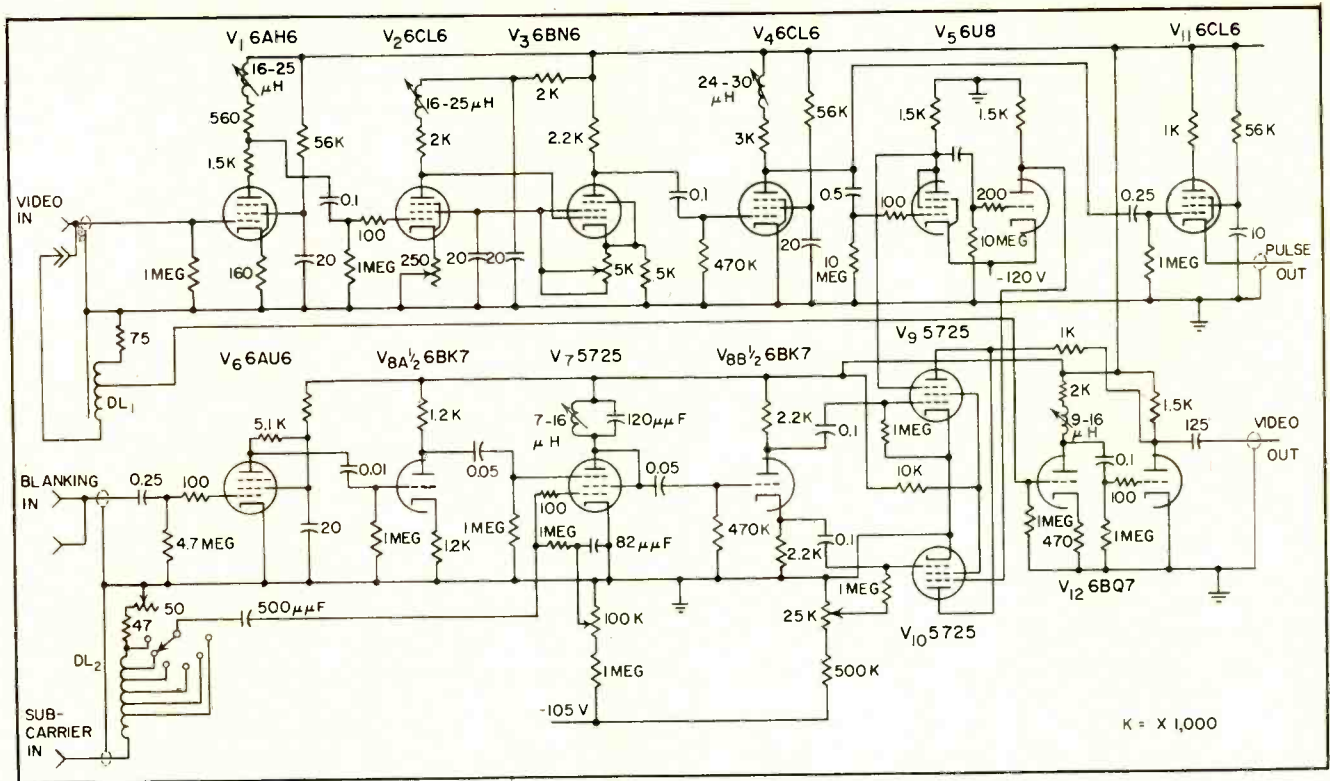

FIG. 4—Circuit diagram of the bicolorimiter that adds two-color information to a monochrome slide signal

trol grid of subcarrier amplifier V_7 .

To prevent subcarrier from appearing during the blanking interval, the station blanking, which is amplified by V_6 and V_{8A} is applied to the suppressor grid of V_7 . Subcarrier amplitude, or color saturation, is controlled by adjusting the control-grid bias of V_7 .

Blanked subcarrier from V_7 appears at phase inverter V_{8B} . Signals of opposite phase from the plate and cathode of V_{8B} are applied to modulator stages V_9 and V_{10} . By the action of the keying pulses, subcarrier of one phase will appear during the time video exists above the clip point as shown in Fig. 5.

When the video potential is below the clip point, subcarrier of the opposite phase will appear at the common plate load. As the keying pulses are of opposite polarity, they cancel at the plates leaving only the subcarrier. To correct for a difference in tube characteristics, a d-c balance adjustment is provided in the grid circuit of V_{10} .

Luminance Channel

Video at the unit input is connected through DL_1 . The line is tapped at a point to provide luminance delay equivalent to that of

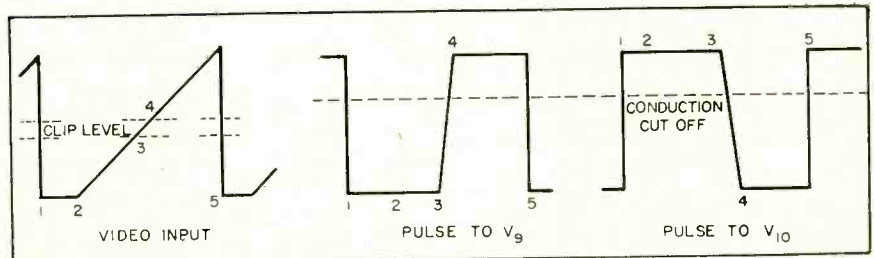

FIG. 5—Pulse circuit waveforms show how video input keys V_9 and V_{10}

the keying circuits. It is then amplified by the first section of V_{12} . From V_{12A} the signal is coupled to the output stage V_{12B} whose plate load is common to V_9 and V_{10} . Isolation is provided by the 1,000-ohm resistor between the plates.

Slide Types

The most useful slide material contains definite, flatly shaded whites, greys and blacks common to most lettered slides. Gradual grey or brightness transitions must be avoided to assure sharpness of clipping action. The ideal clip point is just above the grey material. Here, the whites appear as one color and the greys will appear as the color 180 deg from that of the whites. The blacks reveal little, if any color because of the

luminance value. Slides containing only pure blacks and white are also excellent, but the only noticeable color will be that of the white areas, for reasons of luminance.

The output of the unit is treated as a regular camera signal for switching, since burst is added at the switcher output. With this arrangement it is possible to use the bicolorimiter signal in superimposures with monochrome studio or film cameras. Key inserts may even be used with the bicolorimiter pulse itself providing the keying signal.

The author acknowledges with thanks the original ideas of J. M. Bushnell, chief engineer and the aid and suggestions of James McDaniel, Aubrey Decker and the KVOO-TV engineering staff.

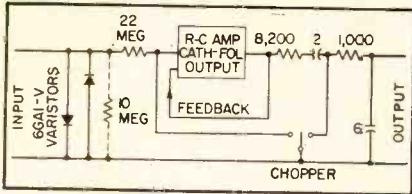

FIG. 1—Simplified diagram of amplifier shows chopper-stabilized and conventional feedback paths

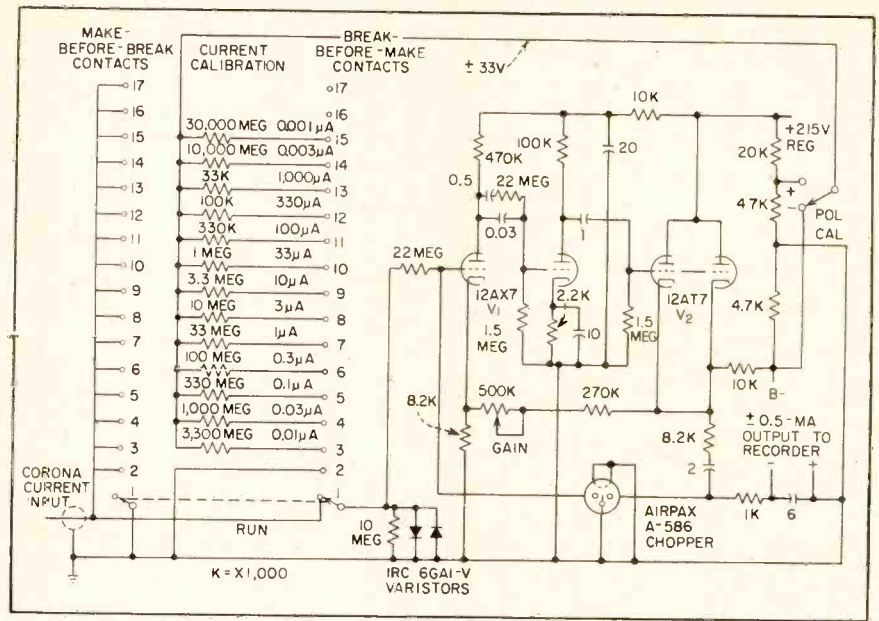

FIG. 2—Logarithmic amplifier includes calibration circuit currents, shown at left. Corona current reaches amplifier through 50 feet of shielded cable

Measuring Corona

SUMMARY — Chopper-modulated feedback signal stabilizes amplifier for measuring radioactive corona-point currents in fair weather. Output signal to recorder is essentially logarithmic, for both polarities of current, in the range from 10^{-9} to 10^{-5} amperes. Built-in calibration remains practically constant through months of service

By **ROY W. HENDRICK JR.**, **FRANCIS G. MARTIN** and **SEVILLE CHAPMAN**

*Cornell Aeronautical Laboratory, Inc.
Buffalo, New York*



Amplifier drives Esterline-Angus recorder from output of radioactive corona point on top of flagpole. Typical fair weather value of corona current is $0.03 \mu\text{a}$

IN an investigation of atmospheric electricity, several years ago, a bipolar logarithmic amplifier¹ operating an Esterline-Angus recorder was used to measure current of either polarity, in the range from 0.1 to $1,000 \mu\text{a}$, from a non-radioactive corona point at the top of a flag pole in disturbed weather.

Recently the nonradioactive corona point was replaced with one containing 320 micrograms of radium 226 so measurements could be made in fair weather too.² The typical value of current from the point is $0.03 \mu\text{a}$ and the minimum current of interest is about $0.001 \mu\text{a}$.

While the old amplifier could be adjusted to record the current down to $0.001 \mu\text{a}$, in the new range

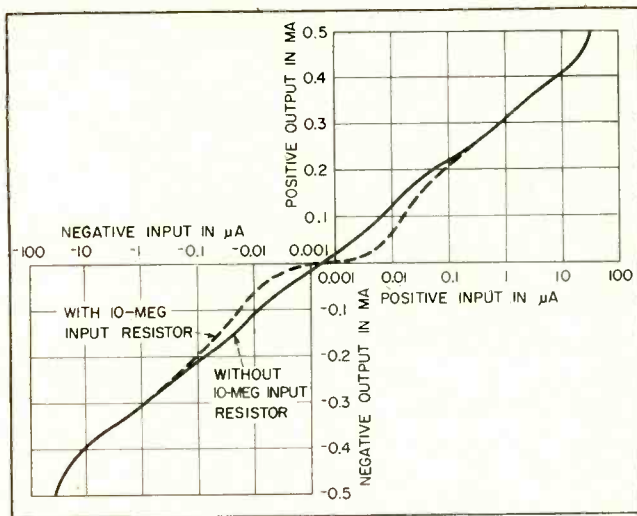
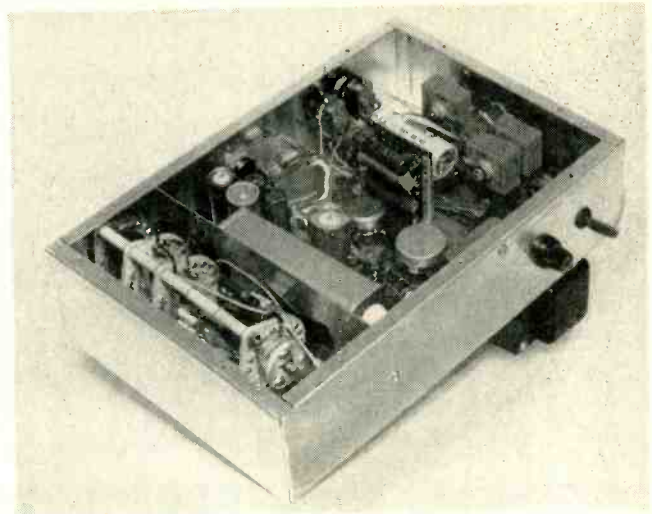

FIG. 3—Overall transfer characteristic of logarithmic-response amplifier with and without input resistor



Underside view of amplifier shows calibration switch at left of chassis in shielded section

From Radioactive Point

of sensitivity it was not satisfactory. Although a majority of the diodes (9004) had suitable logarithmic characteristics, for satisfactory operation the amplifier tube, a 954 pentode, following the diodes should have a grid current of much less than $0.001 \mu\text{a}$ over extended periods of time. One-fifth of new tubes began with a satisfactory grid-current characteristic, but only about a tenth of them would maintain this characteristic through months of service.

Revised Circuit

In a drastic revision, current-sensitive resistors were substituted for the logarithmic diodes, and a chopper-modulated three-triode feedback-stabilized amplifier was substituted for the d-c amplifier. The new circuit is shown in simplified form in Fig. 1 and in detail, with calibration current circuits, in Fig. 2.

When the 10-megohm resistor is shunted across the input, then the calibration is as shown in the dotted curve of Fig. 3; without the resistor, the solid curve applies. The calibration remains practically constant for months—maximum output current deviations are about

two percent of full scale.

Except for the input, the amplifier is a standard R-C type operating as a carrier-frequency amplifier. Feedback around the amplifier stabilizes its gain. The carrier is established by a 60-cps chopper which also synchronously rectifies the output in a shunt rectifier circuit.

Logarithmic Response

The novel portion of the circuit is the input device, a pair of IRC 6GA1-V varistors shunted in opposite polarity. These varistors exhibit a logarithmic response as shown in the overall transfer characteristics in Fig. 3.

The 22-megohm resistor between the varistors and the chopper raises the shunt resistance seen by the varistor pair, preserving their logarithmic response. It also prevents shorting of charge stored in the cable capacitance.

Although changing temperature would alter the calibration, an input current change of about 2.4 percent per degree C for the same output indication, the equipment at present operates in a basement in which temperature fluctuations are small. The six-microfarad capaci-

tor across the output minimizes the recorder pen vibration at fairly large currents.

In disturbed weather, currents of $10 \mu\text{a}$ are common. Since a current greater than $30 \mu\text{a}$ had never been recorded, when the range was extended at the lower end in the new amplifier, it was decreased at the upper end. Actually, the varistors lose their logarithmic characteristic at about 10 to $13 \mu\text{a}$.

Twice in seven years, lightning has struck within 200 feet of the corona point, but unfortunately in neither case has the recorder been turned on. It was hoped to observe the current, perhaps up to $1,000 \mu\text{a}$ just before a lightning strike, but as yet the recorder has not gone off scale at $30 \mu\text{a}$.

The circuit has been in continuous use for 18 months. Except for tube replacement and chopper replacement about every six months, it has required no attention and has been entirely satisfactory in the new range of ± 0.001 to $\pm 30 \mu\text{a}$.

REFERENCES

- (1) Seville Chapman and L. Bogdan, Bipolar Logarithmic Current Amplifier, *ELECTRONICS*, p 136, Jan. 1953.
- (2) Seville Chapman, Electrostatic Field Measurements, Corona Discharge and Thunderclouds, C.A.L. Report No. 68, Mar. 1956.

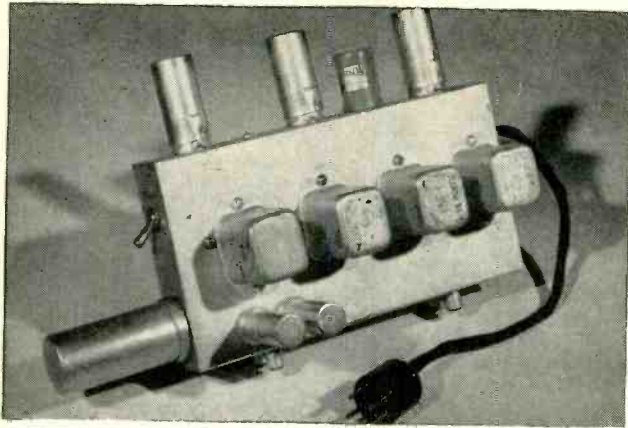

Developmental sync generator for RCA ITV-5 timing circuit, shown in Fig. 2, uses blocking-oscillator counters

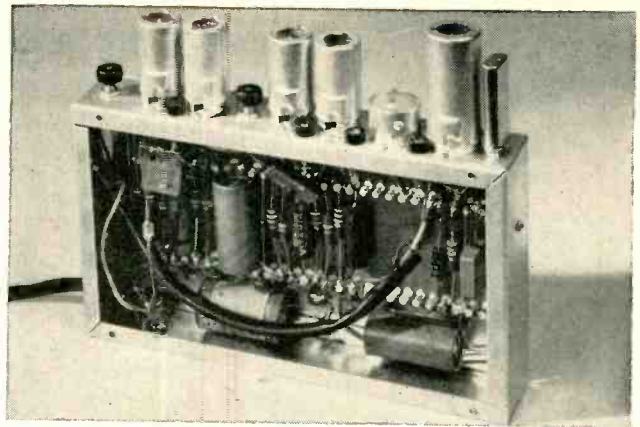

Prototype sync generator for RCA ITV-6 equipment is similar to circuit of Fig. 6, except for master oscillator

SIMPLE SYNC CIRCUITS

SUMMARY — Industrial television systems can use simplified three or four-tube sync-generator circuits because of nonstringent pulse-timing requirements. Three representative designs used in commercial equipment are described. Fourth type, for airborne military application, generates sync electromechanically with serrated-edge wheel and magnetic pickups

By **HAIG A. MANOOGIAN**

Assistant Editor
ELECTRONICS

SIMPLIFIED CIRCUITRY makes industrial-television systems compact, light-weight and low-cost. Compared to conventional broadcast-type equipment, the less stringent timing requirements of industrial equipment offer the greatest opportunity for circuit simplification, permitting use of sync generators with as few as three or four tubes. This article presents a few of the many types of simple sync-generator circuits used in its systems of various manufacturers.

Basic System

In their simplest form, sync generators usually comprise a master

oscillator, operating at twice the line frequency of 15.75 kc, and a countdown chain that divides by 525 to produce 60-cps field-frequency pulses in synchronism with the master oscillator pulses. Of several possible countdown circuits, blocking oscillators are frequently used because each division can be accomplished by a single triode sec-

tion and a saving in B-supply current can be realized. Blocking oscillators conduct only during the short pulse portion of their cycle; at all other times they are cut off.

The sync generator shown in block form in Fig. 1 is a typical blocking-oscillator countdown timing system. Figure 2 shows an application of this system in the RCA ITV-5.

Blocking oscillator V_{2A} generates the 2H frequency of 31.5 kc, which is divided down to 60 cps by blocking oscillators—15 by V_{2B} , seven by V_{2A} , and five by V_{1B} . The 60-cps vertical-rate pulse is taken from the cathode of V_{1B} . Amplifier V_{3B} serves as a buffer stage for the 31.5-kc pulse output from the master oscillator.

Phase detector D_1D_2 compares the 60-cps pulses at the cathode and plate of V_{1B} with the 60-cps line-

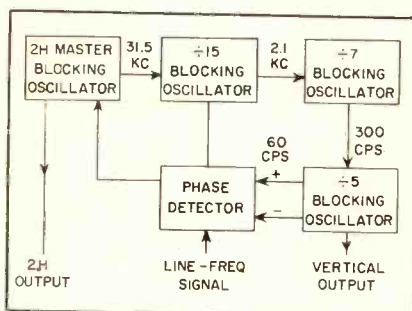

FIG. 1—Typical sync generator uses blocking-oscillator dividers

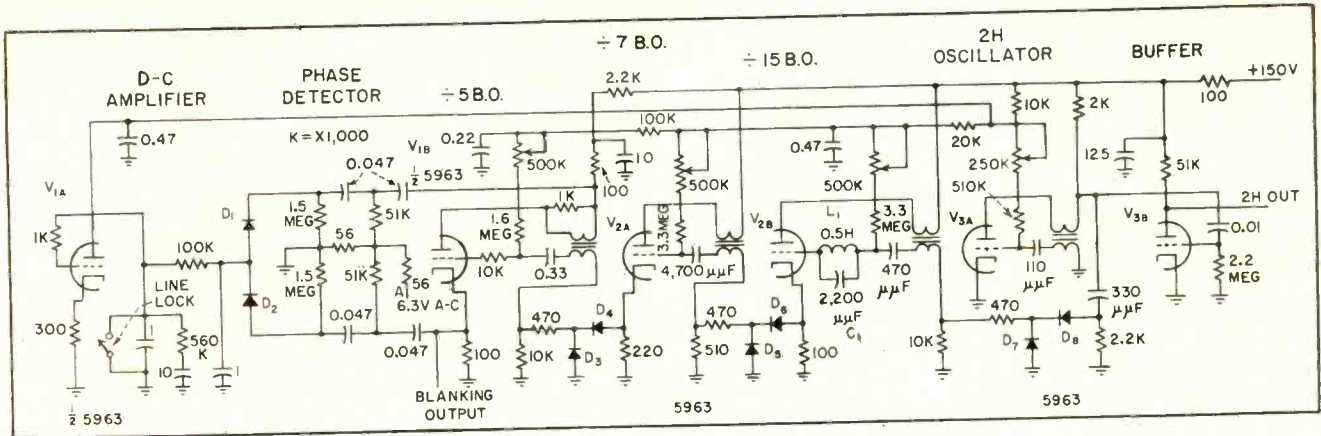

FIG. 2—Three-tube sync generator has three blocking-oscillator dividers and phase-discriminator afc circuit

TIME ITV SYSTEMS

frequency signal introduced at point A. The resulting d-c error voltage is applied as an afc signal to the grid circuits of the 2H oscillator and dividers through d-c amplifier V_{1A} .

Hartley Master Oscillator

Another form of blocking-oscillator divider sync generator is represented by the block diagram of Fig. 3. A Hartley circuit is used as the master oscillator to assure extreme frequency stability when it is expedient to operate the sync generator unlocked from the power-line frequency.

In the circuit diagram of Fig. 4, V_{1A} operates at 31.5 kc. Plate current pulses through R_1 , in series

with the plate supply feed to the oscillator tank circuit, trigger ÷3 blocking oscillator V_{2A} . The output of this stage is divided by seven, five and five, by V_{2B} , V_{3A} , and V_{3B} respectively. The 60-cps vertical-rate frequency is obtained from the cathode of the last divider, V_{3B} .

Positive and negative current pulses from the cathode and plate

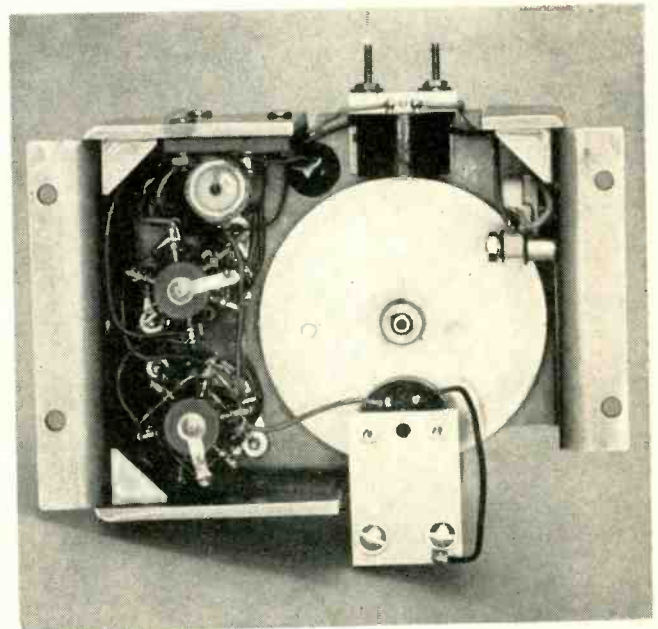
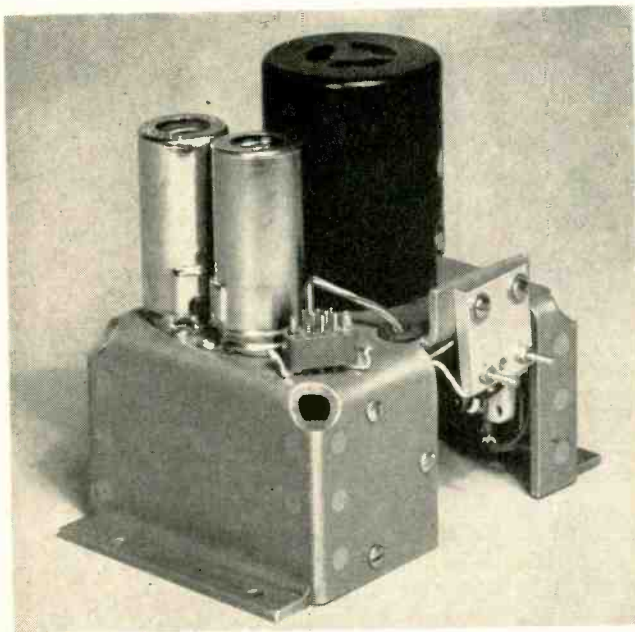

Mechanical tone wheel assembly is used in sync generator for Avion's airborne navigation-situation display television system. Chassis is made extra rigid to minimize timing errors from flexing and vibration

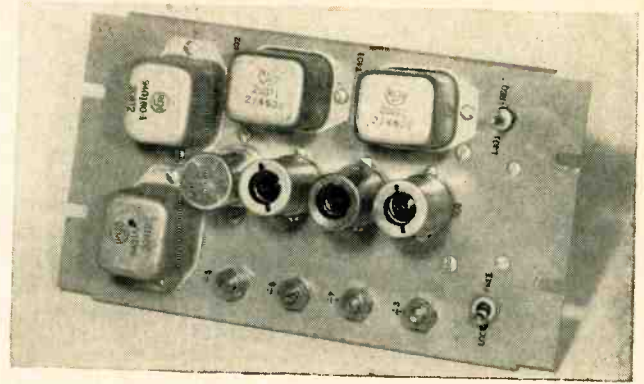
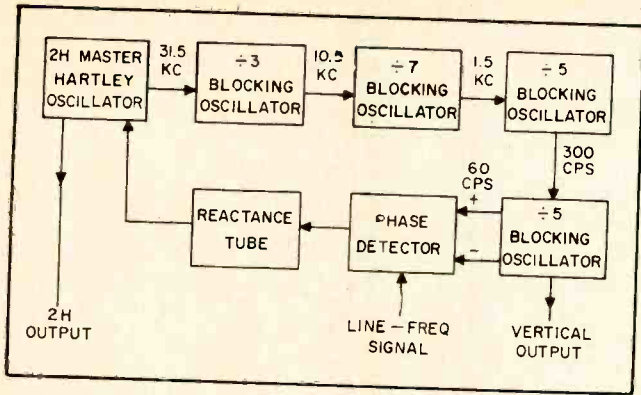

FIG. 3—Block diagram (left) of sync-generator chassis (right) used in GPL PD-150 industrial-television system

circuits, respectively, of V_{3B} are compared to the 60-cps line-frequency reference sine-wave voltage at point A in a conventional phase-discriminator network, similar to that in Fig. 2. The output of this network is a d-c voltage whose polarity is determined by whether the pulse frequency is higher or lower than the reference frequency and whose amplitude is proportional to the frequency deviation. This control voltage is applied to the grid of reactance tube V_{1A} when S_1 is in the lock position. The reactance tube changes the frequency of the Hartley oscillator to

produce a minimum error signal in the feedback loop.

When S_1 is in the free-running position the error signal is shorted out.

As used in the GPL PD-150 itv system, this sync generator holds frequency over a range of ± 2 cycles of the reference line frequency and will pull into lock within a range of ± 1 cycle of the reference line frequency, with S_1 in the lock position.

Triggering Stability

One of the most serious problems encountered in the use of blocking

oscillators in frequency-divider chains is that the large amplitude pulses, which occur when a blocking oscillator fires, kick back into the circuit of the blocking oscillator that is providing the trigger and upsets its operation. Unless extreme care is taken in the triggering circuit employed, kickback will cause both the preceding and following blocking oscillators to fire together.

In the circuit of Fig. 2, the pulse-steering networks consisting of D_3D_4 , D_4D_6 and D_7D_8 prevent interaction of V_{1B} on V_{3A} , V_{2A} on V_{2B} and V_{2B} on V_{3A} . In addition, the trigger-

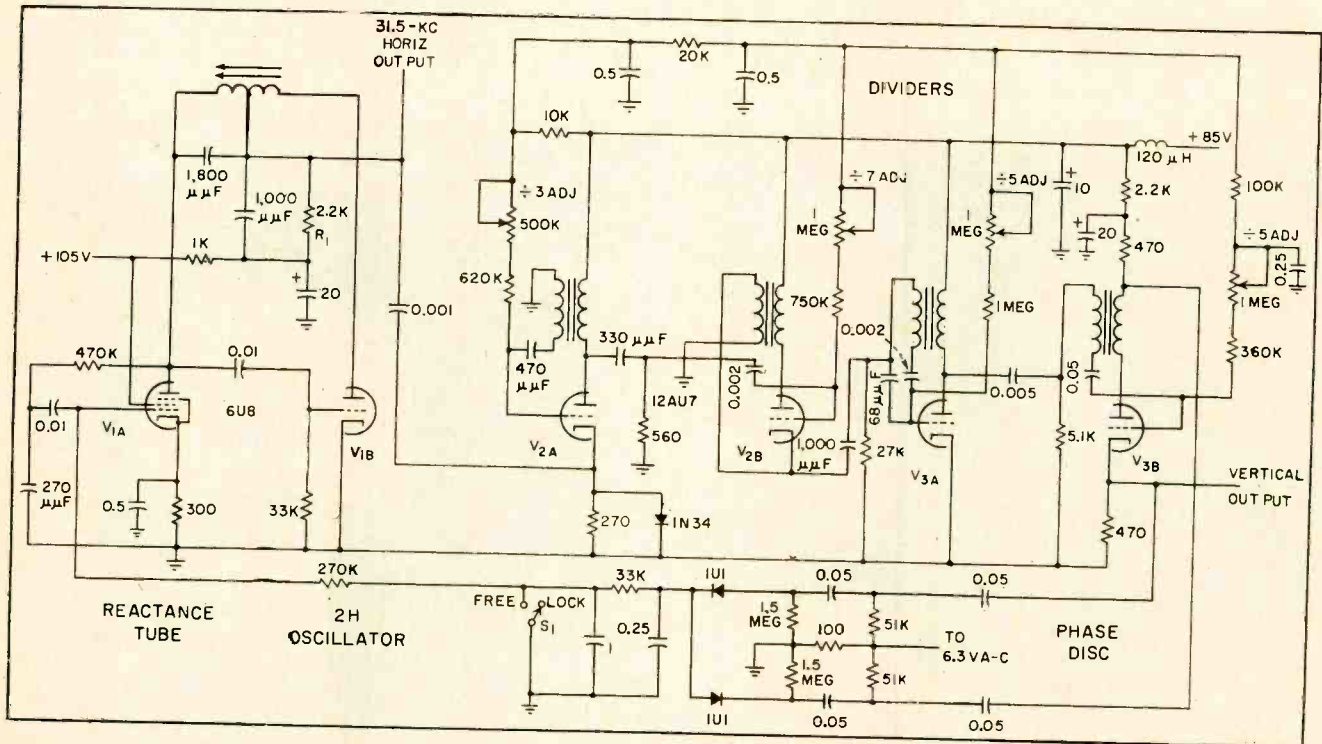

FIG. 4—This sync generator is similar to that in Fig. 2, except for Hartley master oscillator and reactance-tube afc. Grid capacitor-charging circuits of V_{2A} , V_{2B} , V_{3A} and V_{3B} are returned to a positive voltage to increase triggering stability

ing stability of the $\div 15$ stage is further improved by the tuned circuit comprising C_1 and ringing choke L_1 , in the grid circuit.

The kickback problem is circumvented, in the circuit of Fig. 4, by employing the overshoot (Fig. 5) from one blocking oscillator as the trigger pulse for the following stage. Thus, the previous blocking oscillator has finished its cycle and is in a stable cut-off condition before the following blocking oscillator fires. This method can be used since it is not imperative that the leading edges of the field-frequency pulses coincide exactly in time with the leading edges of the line-frequency pulses.

A further increase in triggering stability is obtained in Fig. 4 by returning the grid capacitor-charging circuits of V_{2A} , V_{2B} , V_{3A} and V_{3B} to a positive voltage rather than to ground. In this way, the grid voltage for each tube approaches cut-off at a steeper angle and a larger difference is obtained between the peak voltages of adjacent trigger pulses.

Phantastron Dividers

To obtain more stability than that afforded by the blocking-oscillator divider chain in the ITV-5 equipment, a sync generator based on phantastron-type frequency dividers was developed for use in

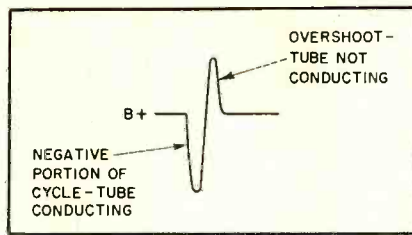

FIG. 5—Positive portion of blocking-oscillator plate waveform is used to trigger next divider stage without pickback

the RCA ITV-6 equipment. The prototype circuit, shown in Fig. 6, has a master oscillator that operates either free-running, line-locked or crystal-controlled, a two-stage phantastron divider that counts down by 525 and a phase-detector afc circuit for line-locked operation.

With S_1 in the line-lock position, V_{1B} operates as a synchronized 2H blocking oscillator. The 31.5-kc output signal across R_1 is applied to the phantastron circuit comprising V_{2A} , V_3 and V_{2B} , which counts down by 25. The 1,260-cps output from the screen of this divider is in turn applied to the second phantastron, V_{4A} , V_5 and V_{4B} , which counts down by 21 to the vertical field repetition rate of 60 cps.

Figure 7 shows, on an expanded time scale, the timing relation in the $\div 25$ and $\div 21$ counters. Note that the duration of the 60-cps vertical output pulse corresponds

exactly to one cycle of the $\div 25$ counter or 25 2H pulses. This removes all jitter from the vertical blanking, as the vertical output pulse, after amplification and shaping, becomes the vertical blanking pulse.

Flyback Stability

As the flyback is the least stable portion of the operating cycle in the phantastrons, the start of the rundown and the start of the flyback are locked to pulses from the next highest counter. For the $\div 25$ counter, the trailing edges of the cathode and screen pulses correspond with the leading edge of the plate waveform that in turn corresponds with the leading edge of a 2H pulse. Thus, the following $\div 21$ counter is triggered at a time corresponding to the trailing edges of these cathode and screen pulses.

Reliable synchronization on the differentiated trailing edge of the cathode pulse is achieved by taking the pulse via V_{4A} and C_1 in Fig. 6. The triggering edge, which corresponds with the trailing edge of the vertical output pulse on the cathode of V_5 , is made to correspond with the leading edge of a 2H pulse. Capacitor C_2 makes the leading edge of the vertical output pulse also correspond with the leading edge of a 2H pulse, by adding the small differentiated pulses shown

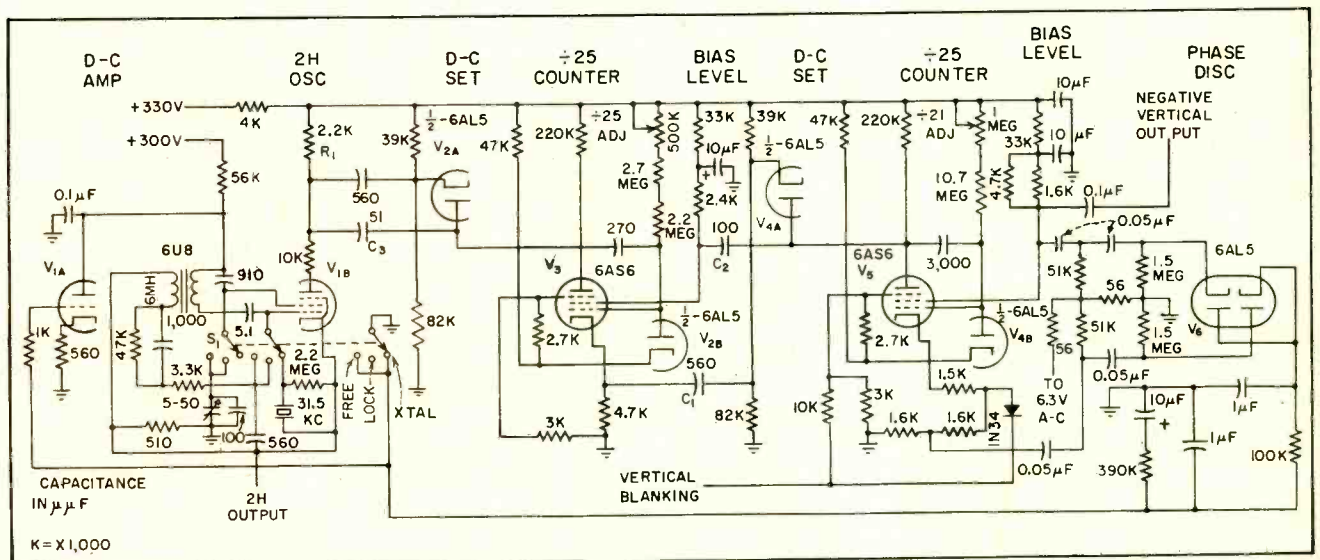

FIG. 6—Four-tube sync generator has phantastron-type dividers and line-locked, free-running or crystal-controlled oscillator. All jitter is removed from 60-ips output pulses by making their duration correspond exactly to 25 2H pulses

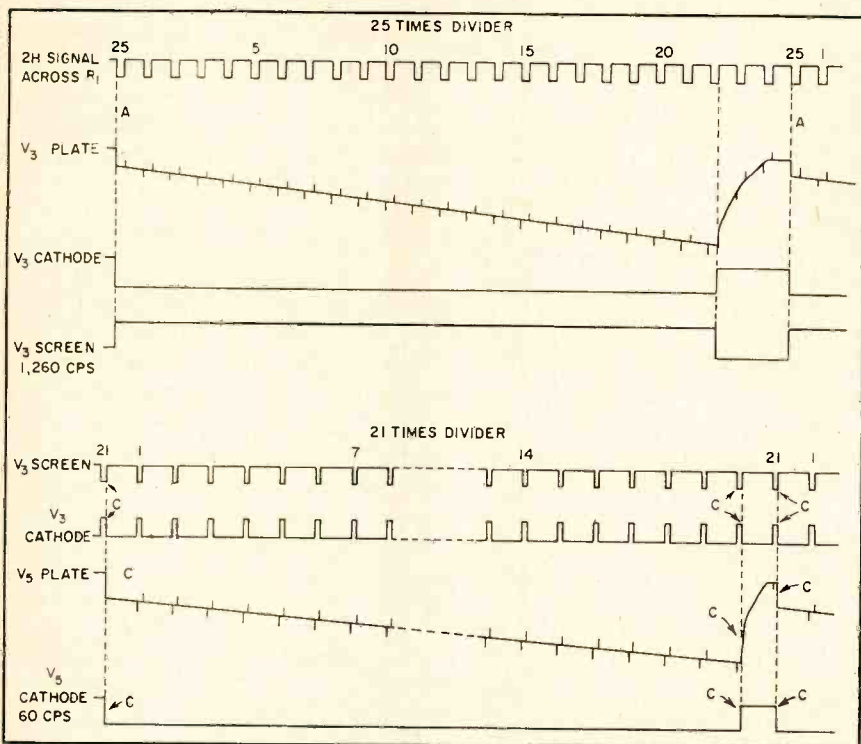

FIG. 7—Timing relationships of phantastron dividers used in circuit of Fig. 6

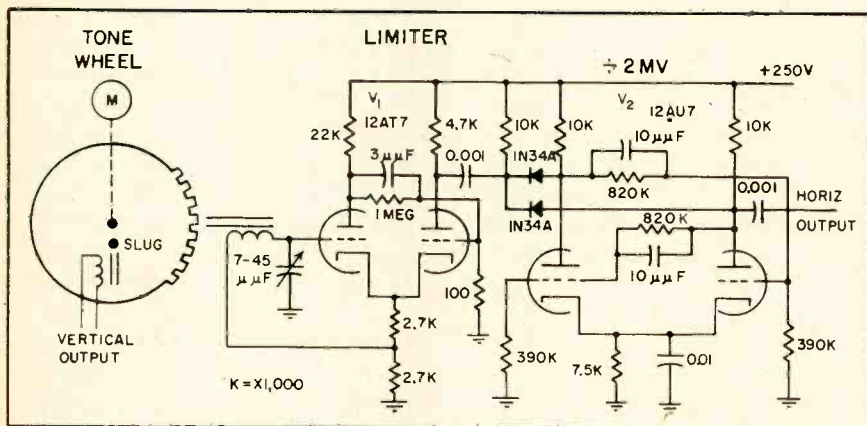

FIG. 8—Electromechanical sync generator has tone wheel with 525 teeth, for horizontal sync, and slug in wheel face, for vertical sync generation

in Fig. 7 to the waveform on the plate of V_3 .

Negative 60-cps pulses are taken from the cathode of V_5 and positive pulses from the plate. These pulses are compared with the power-line frequency in phase detector V_6 . The resulting d-c error voltage is applied as an afc signal to control-tube V_{1A} to lock the master-oscillator frequency to the line.

With S_1 in the free-running position, V_{1B} operates as a free-running blocking oscillator. The latter two modes of operation require the power source to be hum-free to avoid the appearance of slowly

moving hum bars in the monitor picture.

Mechanical Sync Generator

Developed for use in Avion airborne closed-circuit-tv fighter-situation-display equipment, the circuit of Fig. 8 differs from previously discussed sync generators in that a mechanical sync generator provides horizontal and vertical sync eliminating the need for a divider chain.

The system uses a 525-line, 50-field, 25-frame standard to enable the sync generator to be synchronized with the 400-cps line fre-

quency of aircraft power sources.

Since the 400-cps line frequency can vary as much as ± 5 percent, the camera and kinescope deflection signals are obtained from common sweep generators. Use of synchronized sweep circuits, rather than triggered circuits, permits continued operation in case of sync failure, with only a slight loss of resolution and a slight increase in flicker.

The usual master oscillator is replaced by two magnetic pickup units and a tone wheel driven by a 6,000-rpm synchronous motor. One pickup generates a 52,500-cps signal from the 525 teeth on the wheel's circumference and the other pickup generates a 100-cps signal from a slug imbedded in the face of the tone wheel. The signals are essentially sinusoidal with approximately 30-v peak-to-peak amplitude.

The 100-cps signal is used, without shaping, to synchronize a vertical blocking oscillator that counts down by two to the vertical field repetition rate of 50 cps.

The 52,500-cps signal contains some amplitude modulation due to mechanical irregularities in the teeth and runout of the tone wheel. To prevent time jitter of the horizontal sweeps from this cause, limiting along with a countdown by two is performed by biastable multivibrator V_1 .

The 26,500-cps 2H output of V_2 is integrated and applied to a horizontal afc circuit that divides by two to obtain the desired horizontal repetition frequency of 13,125 cps. Every other pulse from V_2 is compared with a H pulse from the kinescope yoke. The resulting error signal is applied to the horizontal sweep generator.

Though a 6,000-rpm motor is used in this prototype, later equipments will use a 3,000-rpm motor to provide vertical field rate and 2H sync signals directly from the tone wheel without frequency division.

The author thanks Lester Flory of RCA Laboratories, Charles Taggart of General Precision Laboratory, Inc. and Sam Romano of Avion Division, ACF Industries Inc. for their cooperation in making available the information on which this article is based.

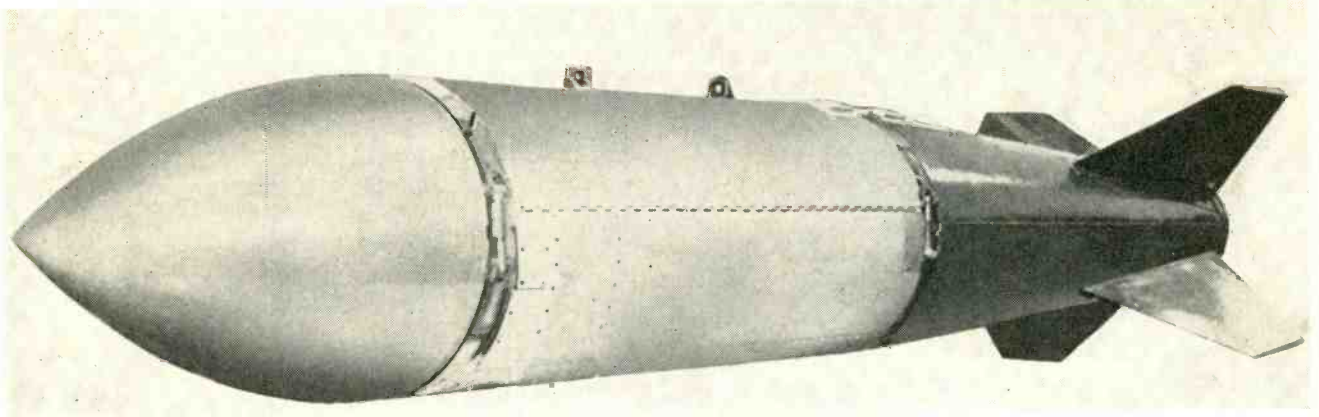

Explosive bolt connectors for nose and tail assemblies release parachutes for center section containing audio system

AIR-DROP SYSTEM BROADCASTS MESSAGE

SUMMARY — High-power sound equipment is designed to be dropped from air to deliver prerecorded message. System including tape reproducer, 500-watt amplifier and five loudspeakers provides three-minute message intelligible over half-mile circle around drop point during descent

By **F. C. FISCHER, A. A. GERLACH and D. S. SCHOVER**

*Cook Research Laboratories
Division of Cook Electric Co.
Skokie, Illinois*

MODERN military tactics require a means of communicating propaganda or instructions to large groups of soldiers or civilians inaccessible by conventional radio transmitters.

This article describes the results of a program to develop a high-power loudspeaker system capable of being carried and dropped by high-speed, high-performance aircraft at altitudes to 60,000 feet. The system is designed to be as inexpensive as possible consistent with reliable one-shot operation. The loudspeaker system provides a minimum of three minutes of intelligible speech over a ground area equal to a half-mile diameter circle

during a parachute-braked terminal-phase of its descent. A minimum articulation score of 80 per cent is required over this ground area in an ambient noise environment on the ground of 85 db of random or propeller-driven aircraft noise.

The loudspeaker system consists of a 500-watt amplifier and horn system broadcasting a tape recorded message. This equipment is housed in a 3-section bomblike container, shown in a photograph.

The conical tail section contains the brake parachute with its firing device and the main parachute. The cylindrical center section consists of an aluminum framework

housing power, audio, acoustical and control systems. The nose section contains the nose parachute and serves to protect the speaker horn assembly during storage and while unit is being carried aboard an aircraft.

Physically the assembled missile is 119 in. in length and 19 in. in diameter.

Operation

When the missile is released from the aircraft two switches apply operating voltage to aneroid switch contacts and open all safety shorts on explosive devices used to separate the sections of the missile.

When the missile reaches a preset

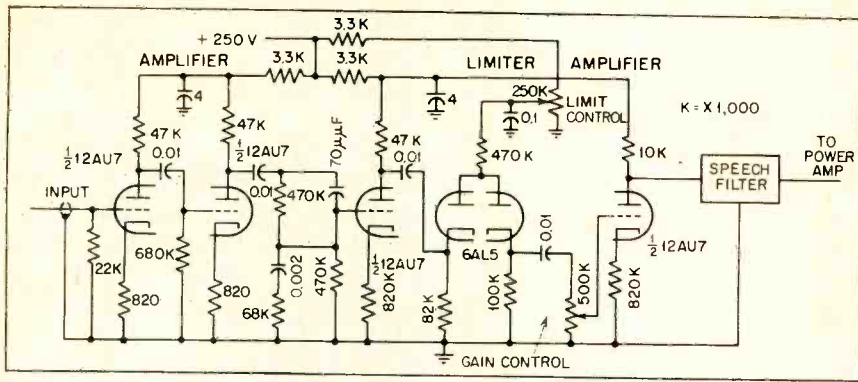

FIG. 1—Preamplifier for tape playback unit provides drive for 500-watt amplifier

as an amplifier and the second half as a phase inverter feeding a pair of 6AQ5's in push pull. The final stage is a class-AB₁ 500-watt amplifier employing two type-813 output tubes. The over-all frequency response of this system, including playback unit, preamplifier and driver to the grids of the 813 amplifier, is flat within ± 5 db from 200 to 5,000 cps.

Power Source

Voltage requirements of the system are supplied by a mercury-cell battery pack. This high voltage supply consists of 12 series-connected batteries giving a total no-load voltage of 2,880 volts. Each battery contains 180 mercury cells, series-parallel connected to give a no-load voltage of 240 volts per battery and capable of supplying a total load current of 400 ma. Each of the twelve batteries weighs about 20 pounds and is 12 inches high with a four-inch rhombic cross section.

Mercury-cell packs are also used to supply the 90-volt power-amplifier bias voltage and recorder drive-motor requirements. All filament voltage is supplied from five type BB-238 U wet cells.

Electroacoustical System

The output of the power amplifier feeds an electroacoustical system located at the nose end of the missile center section. This system utilizes five permanent-magnet drivers.

A brass manifold couples the acoustical output of the five drivers to the horn. This manifold section consists of five identical throat sections with an approximate exponential flare and a cross-section transitional from a circular to a 70-deg pi section curved to accommodate the mounting space requirements of the drive units. The horn taper is exponential and roughly tangent to the throat taper at the matching plane.

This combination results in a satisfactory impedance characteristic over the speech range. A mouth diameter of 15½ inches provides a beam width of approximately 50 deg at 1,000 cps.

In preparing the taped message

altitude the aneroid switches initiate an internally programmed control sequence. The brake parachute is opened first. At a time sufficient to slow the missile from a velocity of 1,000 feet per sec to 100 feet per sec, the tail section is separated from the midsection, releasing the main parachute.

Three and one-half seconds later, the nose cone is separated from the midsection, releasing the nose parachute.

When the center section of the missile reaches an altitude of approximately 4,000 feet the sound reproducer system is placed in operation. The center section descends to earth at a rate of 14 feet per sec broadcasting its 3-minute tape recorded message during the descent.

Electronic Equipment

The electronic system consists of magnetic-tape transport, preampli-

fier, 500-watt power amplifier and battery power supply. The magnetic-tape transport shown in a photograph is a compact light-weight playback unit designed to reproduce messages recorded on ¼-inch plastic tape. Standard 3-inch NARTB spools, capable of holding approximately 200 feet of tape are used to give a total message time of 5.5 minutes at a tape speed of 7.5 inches per second. Signal-to-noise ratio is 60 db with wow and flutter of 0.25 percent. The 6½ by 5 by 5-in. unit weighs 3 lb 10 oz.

The preamplifier shown in Fig. 1 utilizes a three stage R-C coupled amplifier compensated to give a flat frequency response. This is followed by a 6AL5 diode limiter feeding a fourth stage of amplification which in turn feeds a speech filter designed to obtain maximum intelligibility.

The power amplifier, Fig. 2, has one 12AU7, half of which is used

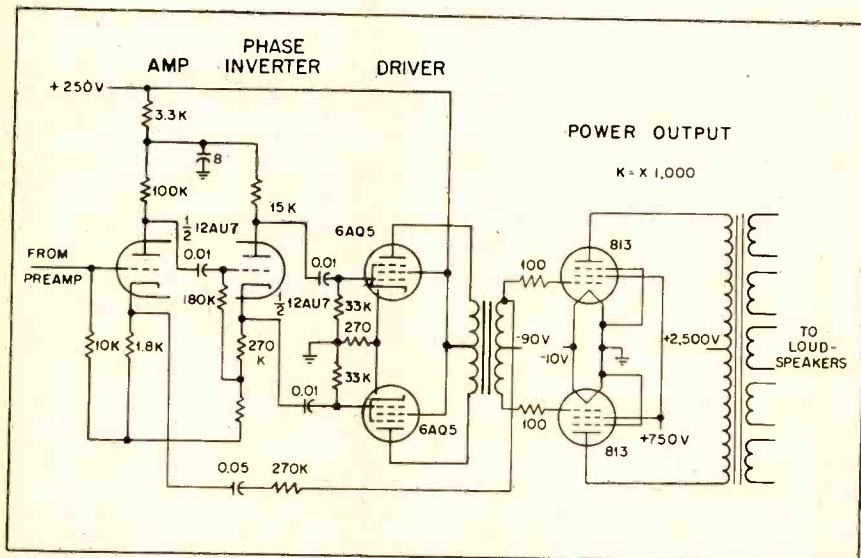
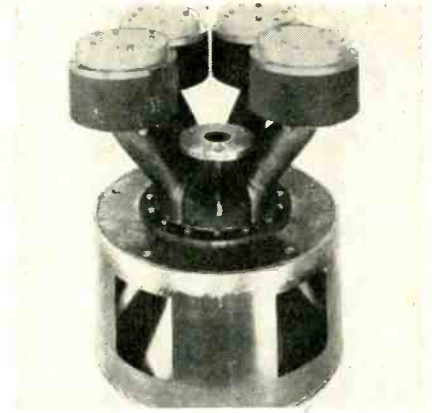
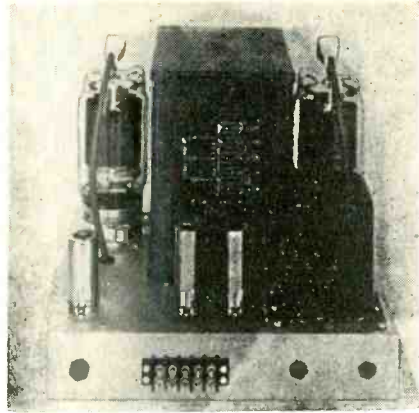
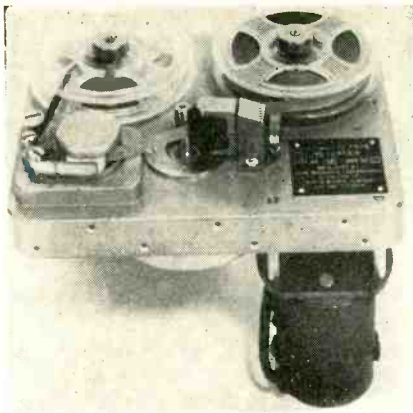

FIG. 2—Two type-813 tubes are used in push-pull to provide 500-watt power-amplifier output to five loudspeaker drivers



Tape player (left), amplifier (center) and loudspeaker drivers (right) are major components of droppable sound system for air-to-ground communications. Tape reels hold enough tape for over five minutes playing time at 7.5 inches per second

used in the reproduction system, speech characteristics are modified for maximum intelligibility. Acoustical flight tests indicate an approximate 6 db per octave frequency attenuation above 600 cps which is corrected by employing frequency preemphasis in the recording process.

With an average power input to the drivers of 500 watts, power peaks in excess of the rated value of the driver units are present. To avoid possible damage to the drivers, speech clipping is employed during recording.

Use of this technique increases the effective sound power output of the system with no degrading effect on the speech intelligibility. A bandpass filter is employed to reduce the output of all frequencies outside of the 300-cps to 3,000-cps speech band.

System Evaluation Tests

System evaluation tests consisted of several missile drops. Reports of 100-percent intelligibility were obtained well outside of the half-mile diameter test circle. An observer

located one mile off the speaker axis with the system at an altitude of about 4,000 feet reported 100-percent intelligibility of the message from the sound system even though his hearing was impaired by an intercom head set he was wearing at the time.

The final system evaluation test demonstrated the feasibility of the droppable method of sound transmission by the high intelligibility obtained with less power than is required by the usual airborne systems.

Further Development

Subsequent to the development of the present model of the droppable loudspeaker system, considerable progress has been made in the development of improved air stream modulating horn drivers. In the light of these developments it may be advantageous to incorporate an air-modulating driver into the sound system. Although such a modification would not appreciably reduce the over-all power requirements of the sound system, the resulting pneumatic power source

should be more compact and less expensive. In this type of system a 10 to 20-watt audio amplifier would be required for modulating the air stream. An amplifier of this size could be transistorized, effecting a substantial reduction in the size and weight of the amplifier assembly, in addition to lowering the battery voltage requirements for the equipment.

These design changes would result in a lighter and more compact package, which in turn would decrease the requirements of the final descent parachute. A modification of the present assembly could be accomplished which would facilitate handling and transporting the units in a bomb cluster arrangement. It is conceivable that one aircraft could carry and drop as many as ten of these units which could cover a large ground area with a minimum risk as to the loss of aircraft and personnel.

The final model of the loudspeaker system is the result of the coordinated effort of many individuals. Credit is due to F. P. McGowan, C. J. Pelc, James Penick and other members of the Instrumentation Section of the Cook Research Laboratories.

The authors would also like to express their appreciation to members of the Communication and Navigation Laboratory of the Wright Air Development Center who sponsored the work on the droppable loudspeaker system. We are particularly indebted to R. L. Biles, L. Theroux and R. Kellogg for their continued guidance and support.

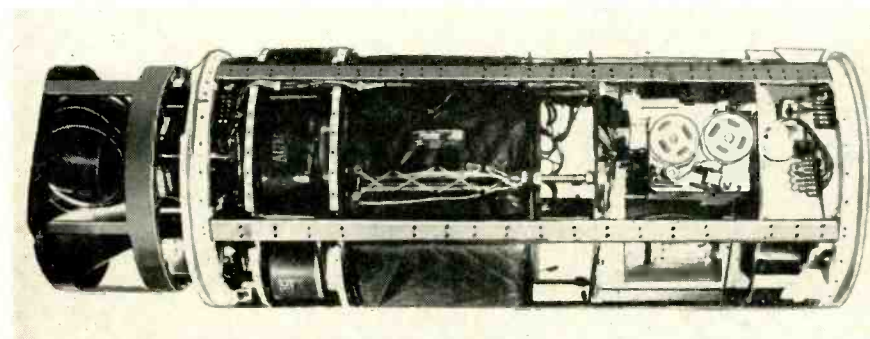

Audio section of droppable sound system. Loudspeaker horns are at left and tape reproducer at upper right. Padded center section provides heat for batteries

Ground-Controlled Drone

By FORREST WARREN and CARLTON CORDEN

Project Engineer Ryan Aeronautical Co. Systems Group Engineer
San Diego, Calif.

SUMMARY — Roll and pitch data systems control drone target used for missile testing at near-sonic speeds. Programmed turns and climb and dive controls permit operator to maneuver plane over preselected course or to test avoidance techniques

MISSILE flight testing requires a target for near-miss attacks capable of speeds comparable to those of a manned aircraft and also capable of changing course to test avoidance of the missile.

The Firebee turbojet drone is a reusable target controlled from the ground. At completion of a test flight, a parachute is released to lower the drone to the ground for recovery.

Control System

An automatic stabilization and control system permits the drone to maintain stable flight and to follow the commands of the remote-control operator. Position of the drone is recorded through a radar tracking system and radar plotting

board. Maneuvers are initiated by a remote-control box.

Provisions are incorporated in the airborne part of the control system to receive and decode command signals by means of a radar control receiver and decoder unit. These signals actuate the aircraft control surfaces through the autopilot and control engine throttle.

Stabilization and control of the drone in flight is accomplished by ailerons for roll, elevators for pitch, and rudder for sideslip. The system is shown in Fig. 1. Automatic stabilization is provided about the roll and pitch axes. The sideslip or rudder trim control is commanded by the remote operator.

The autopilot data system consists of two cascades of low-im-

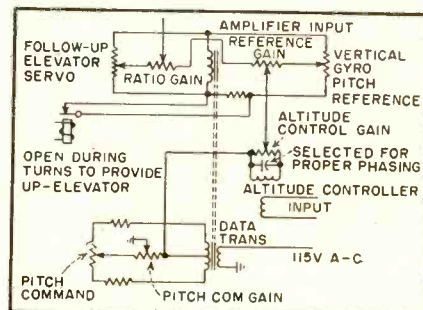

FIG. 2—Displacement bridge of airborne equipment pitch data system is operated from gravity-erecting vertical gyro

pedance a-c bridges, the roll data system and the pitch data system.

The pitch data system, Fig. 2, consists of a displacement bridge which contains the vertical gyro and follow-up pick-offs, a pitch command bridge, and an altitude controller pick-off, the outputs of and follow-up pick-offs, a pitch error signal.

The roll data system shown in Fig. 3 consists of the roll-displacement and roll-rate bridges, and the displacement and rate follow-up units. These outputs are combined to form a roll error signal which is supplied to the roll amplifier.

The functions of the autopilot and remote control system are best illustrated by a typical mission. After release from the mother plane, approximately five seconds is allowed for the drone to pick up sufficient flying speed and to damp out initial launching disturbances. The remote operator then transmits a straight-and-level command.

In the drone, a synchro is clutched to an evacuated aneroid element giving an output propor-

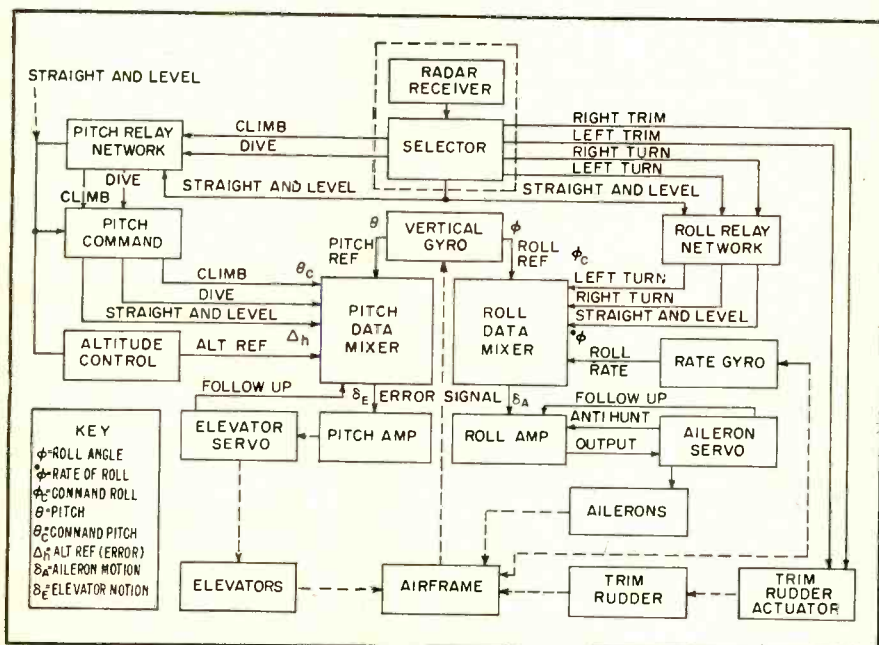

FIG. 1—Block layout of airborne equipment for remote control of drone

TESTS MISSILES

THE FRONT COVER

tional to deviations from the reference altitude at which the straight and level command was transmitted. The output of the altitude controller is combined with the pitch attitude and elevator position signal to provide the elevator trim position necessary to maintain level flight.

When sufficient airspeed has been attained, a climb command is transmitted by the operator.

In the drone, the climb signal actuates a motor driving a potentiometer in the pitch data system and introduces an error voltage to the vertical gyro. Balance in the data system is achieved when the drone assumes the commanded pitch attitude. During climbs, the altitude controller is rendered inactive. Prior to transmitting a turn command, the operator commands straight-and-level. This allows the



Turbojet drone dropped from plane is ground-controlled target for missile tests

drone to level out and regain airspeed lost during the climb.

A left-turn command is transmitted by momentarily holding the control stick to the left. In the drone, the left-turn relay is locked electrically through the climb, dive, and straight-and-level relays. In the event that the pilot does not command straight-and-level before the turn, the altitude controller will be automatically engaged. Closure of the turn relay creates an unbalance in the roll-data system con-

taining the vertical gyro and the roll-rate gyro. Simultaneously, the pitch system is unbalanced slightly to provide up-elevator.

The angle of bank is preset to 45 deg at altitudes below 30,000 ft and 30 deg above 30,000 ft. A bank angle is normally selected automatically by a barometric switch in the drone. The turn will continue until a straight and level, climb or dive command is given.

Vertical Turn

Due to the high speed of the drone, conventional horizontal turns were not considered desirable because of the excessive time required to perform a course reversal. A programmed vertical turn was decided upon.

This required gyro precession about both axes on command. This unit acts as a normal data reference to furnish roll and pitch information. When a course reversal is commanded, a program timer takes control and the gyro is precessed in pitch to cause the drone to perform a partial loop. The gyro is then precessed in roll, righting the airplane, and ultimately pulling up to level the drone at approximately the same altitude as at start of turn, but in reverse heading.

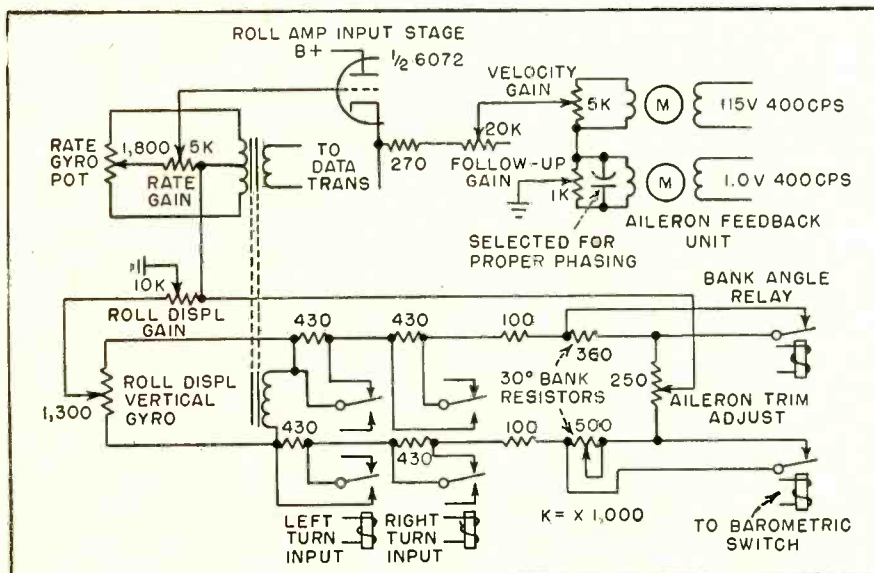

FIG. 3—Roll data section is controlled by vertical gyro and roll rate gyro

Wide-Range Analyzer

SUMMARY — Sweep generator in conjunction with heterodyne spectrum analyzer measures attenuation characteristics of frequency-selective networks. Equipment can measure band-stop regions down to attenuations of 100 db within the range of 20 cps to 20 kilocycles. Bandwidths below 10 cps are obtainable

MEASUREMENT of attenuation characteristics of filters and other frequency selective networks is facilitated by a composite instrument comprising a swept heterodyne spectrum analyzer used as an indicator for a sweep generator.

By placing a network between the generator and the indicator,

curves may be traced showing relative gain against frequency.

This system responds to fundamental components only because of the tuned indicator. Hence harmonics, hum and other spurious are effectively eliminated from the transfer functions plotted.

The function of the audio sweeper and audio analyzer shown in

block form in Fig. 1 is to convert the output of the swept r-f oscillator to the audio band and present it at a uniform amplitude and convenient impedance level.

Other bands may be examined with similar instruments.

System

By heterodyning the swept r-f oscillator output with a fixed frequency equal to the analyzer i-f, the difference frequency arithmetically tracks the frequency being examined by the analyzer. Adjusting the inductance Z_1 of the crystal-controlled oscillator in the sweeper unit of Fig. 2 for maximum amplitude on the crt shifts the fixed beat frequency for precise registration that occurs when the crystal-oscillator frequency is at the center of the i-f bandpass.

Thus the panoramic indicator is locked to the sweeper output and samples a small band defined by plus and minus one-half the i-f bandwidth about the instantaneous output frequency.

The operating controls which determine the center frequency, sweep width and choice of linear or logarithmic scanning modes are located on the analyzer. They provide adjustment of the swept oscillator frequency excursions and self-frequency.

The sawtooth modulating wave is obtained from the external triangular-wave generator or the one-cps time-base generator. It also drives the horizontal deflection stages and establishes a calibrated linear incremental or directly read logarithmic frequency scale on the crt.

The sweeper unit input stage

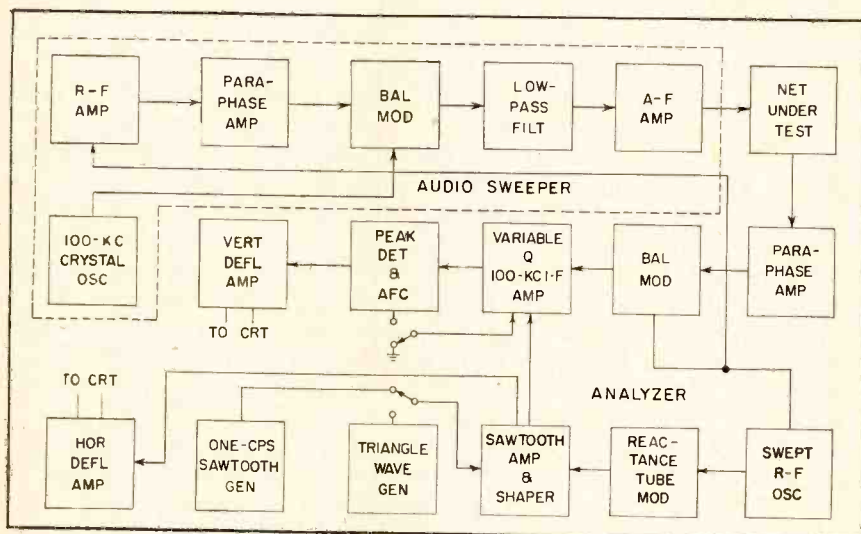

FIG. 1—Block diagram of audio sweeper and network analyzer

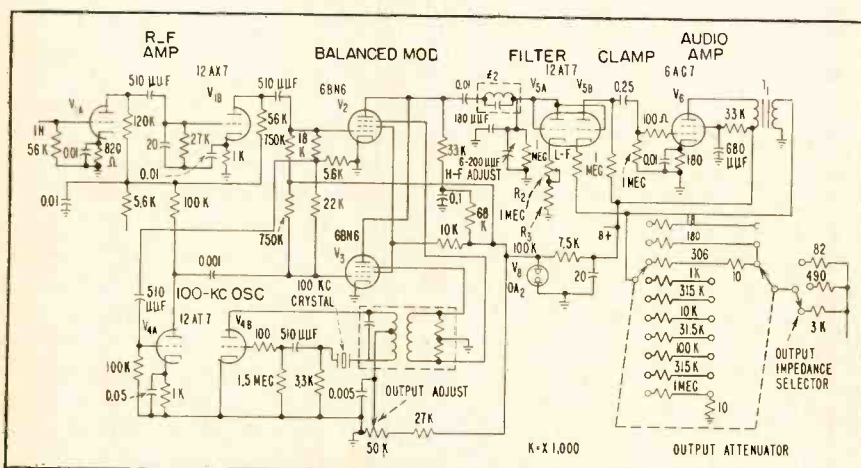

FIG. 2—Slave sweeper provides signal to drive network under test

Traces Precise Curves

By **EDWARD F. FELDMAN**

Senior Engineer
Panoramic Radio Products
Mount Vernon, New York

V1A is an r-f amplifier operating in the 80-100-kc band. It is driven at low level from a loosely coupled secondary winding on Z_7 in the analyzer of Fig. 3 to preclude excessive loading and potential oscillator instability. After further amplification and phase splitting in V_{1B} and V_{4A} , the conversion to audio is effected in the pair of 6BN6's, V_2 and V_3 arranged as balanced modulators.

The modulator-tube suppressor grids are driven in opposite phase through the transformer-coupled output of the crystal-controlled 100-kc oscillator V_{4B} . Suppression of the high-level 100-kc component is vital to prevent over-driving the output amplifiers and to minimize i-f response in the analyzer. Network, Z_8 , is parallel tuned to 100 kc and constitutes the voltage divider, with C_1 and C_2 , which attenuates any unbalanced i-f output of the modulators. These capacitors also form a series resonant combination with the inductor of the r-f trap in the coil.

Capacitor C_2 adjusts the amount of treble boost.

The combination of C_2 and R_2 plus R_3 in parallel with R_1 is



Panoramic sonic analyzer serves as selective indicator for sweep generator in the 20 to 20,000-cps range when measuring attenuation characteristics of networks

aligned for optimum bass frequency response. The diode connection of V_{5A} in conjunction with C_3 is a clamp tending to hold the grid of the audio amplifier V_{5B} negative to prevent horizontal oscillator flyback pulses, which cause shock transients in the output, from drawing grid current causing a minor blocking condition affecting gain.

The feedback from the secondary of T_1 to the cathode of V_{5B} serves to improve the bass response by counteracting the transformer low-end fall-off. Overall response is within 1 db to 40 cps and to 20 cps is within 3 db of mid-band gain. Harmonic distortion introduced by the diode does not deteriorate the

instrument response as traced on the selective indicator because of the narrow-band i-f filter. With a minimum dual-stage bandwidth of 10 cps, sufficient harmonic rejection may be obtained fundamentals down to 20 cps.

A range of 100 db in steps of 10 is obtained in the output attenuator. Looking back from the output impedance selector, the impedance is roughly 20 ohms at all attenuator settings. The nominal output impedances provided are 100, 500 and 3,000 ohms.

Receiver

The analyzer, shown in Fig. 3, is a superheterodyne receiver with its local oscillator periodically frequency modulated. Audio frequency input signals are attenuated and divided into two equal and opposite components which feed the grids of the balanced modulators, V_2 and V_3 . The local oscillator $V_{15.1}$ output is connected to the common cathodes of the 6SJ7 converters. Signal frequencies and heterodyne difference components are produced push-pull while the in-phase local oscillator outputs cancel in the plate circuits.

The 100-kc modulator output



Rack-mounted triangular-wave generator and signal alternator provide variable scan and ability to compare signals for precise measurements

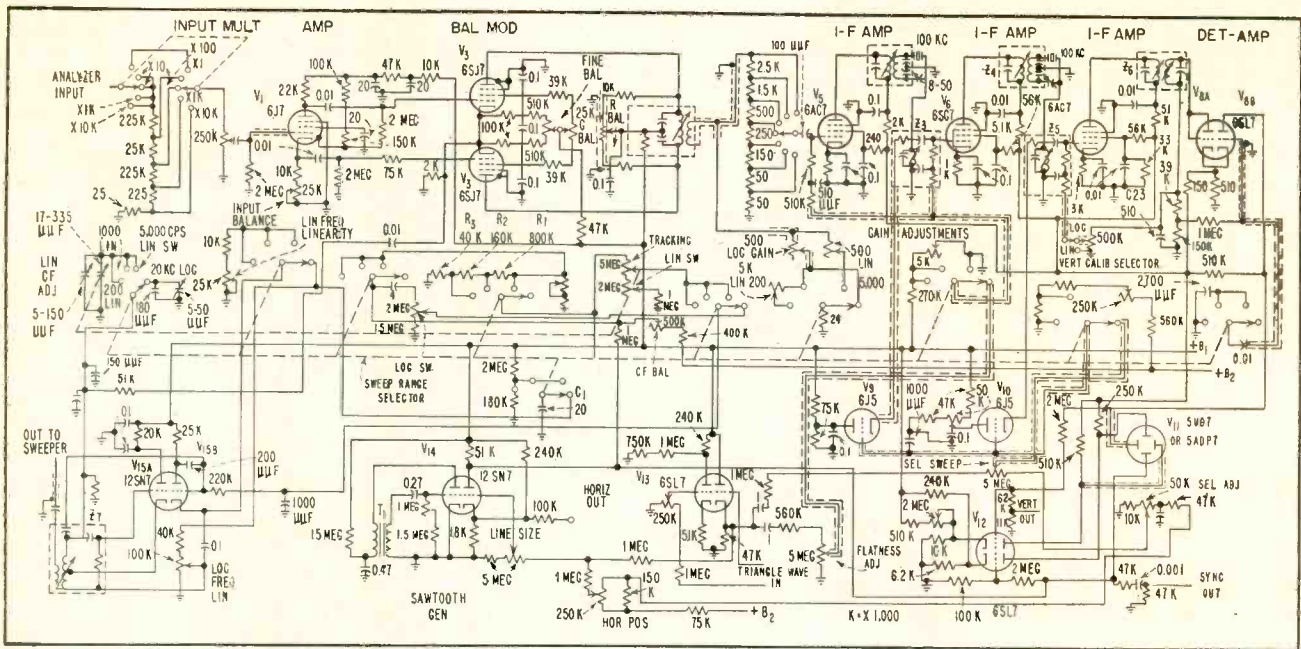

FIG. 3—Analyzer accepts input from network under test and displays its response

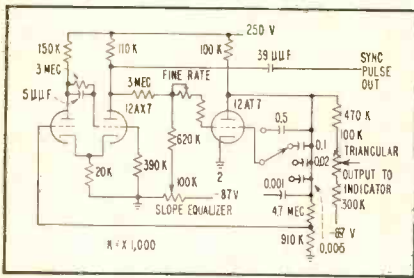

FIG. 4—Triangular-wave generator provides accurate sweep for indicator

eliminates any response to the input frequencies. The balance controls are adjusted for minimum local oscillator response near zero frequency where it sweeps through the i-f.

A Miller-effect reactance stage, V_{15B} , is connected across the tank circuit of the grounded plate local oscillator. As the sawtooth wave-

form from the time base generator drives the reactor grid, the impressed tuning capacitance varies directly as the instantaneous gain multiplied by the plate to grid capacitance. The 200 μ f capacitor serves to multiply the inherent Miller effect of the triode reactance tube.

Scanning Modes

Logarithmic frequency scan from 40 cps to 30 kc is obtained by addition of an integrating R-C network in the cathode of the reactor including the 20 μ f capacitor, C_1 . The ± 10 percent frequency modulation of the local oscillator is in excess of the usually achieved linear excursion with a high-Q reactance network. Since curvature of μ and r_p characteristics of the triode affect the resultant fre-

quency calibration over the broad band utilized in the log sweep, each crt screen is plotted individually.

Only the one-cps scan rate derived from the sawtooth generator, V_{14} , may be employed with the broad-band log scan because of the dependence of the reactor integrator network upon sweep time. The variable-rate bidirectional sweep mode could not be used with the nonlinear scan mode because the forward and return traces would not coincide.

Expanded linear analysis provides magnification of a small spectrum to note critical regions. Excursions of 5-ke, 1-ke and 200 cps are provided with continuously variable center frequency from 0 through 20 kc. The sweep widths are fixed by the resistor divider chain, R_1 , R_2 , and R_3 which pick off the desired fractions of the sawtooth amplitude.

Bandwidth of the i-f amplifiers is determined by the dual 100-ke crystal filters of V_6 and V_6 . A pair of cathode followers V_9 and V_{10} reflect the variable resistance into the i-f crystal loading network and govern the overall Q.

Selectivity

During the logarithmic sweep, with varying instantaneous rates of scan, the selectivity is increased synchronously as the low end of

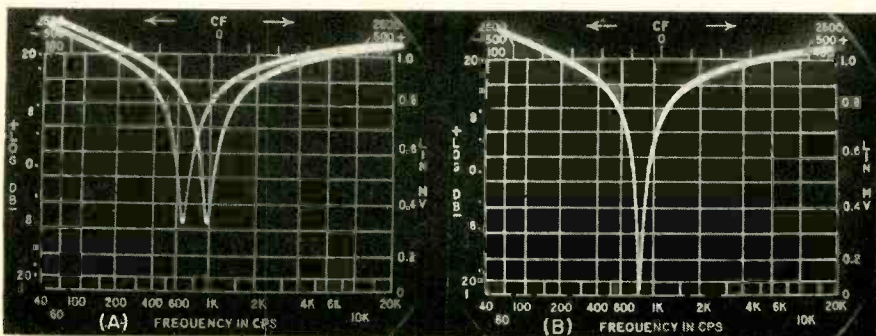

FIG. 5—Curves show excessive forward and reverse scan rate (A) and correct scan rate (B) to see proper response of network

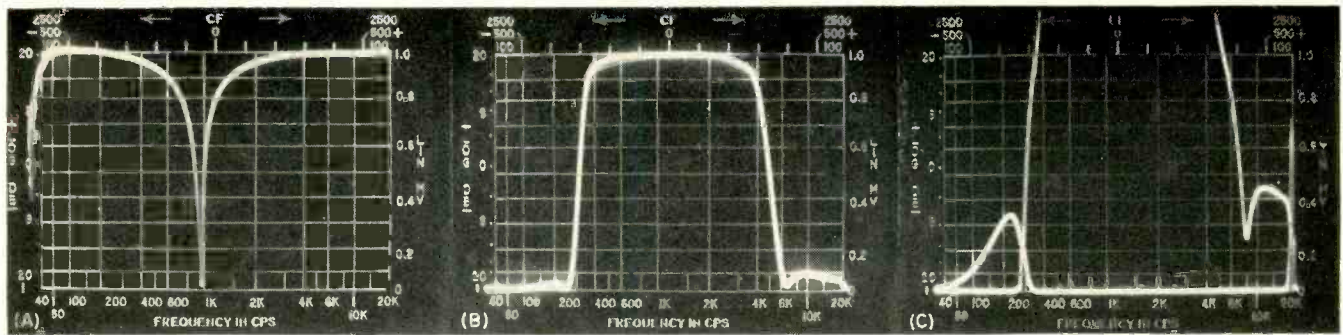

FIG. 6—Curves show log-log response of active R-C filter (A), f-m/f-m telemetry subcarrier filter response (B) on linear frequency and logarithmic amplitude scales and same response (C) with indicator gain 20-db higher

the audio spectrum is approached. A shaped sawtooth from the time-base generator drives the grids of the selectivity modulators V_6 and V_{10} . On linear scans, i-f bandwidths are fixed by a d-c grid potential on these tubes in accordance with the sweep width selected.

In curve tracing, the requirements for selectivity depend upon the nature of possible spurious components such as harmonics, hum, noise and upon the frequency being examined. Generally, lower frequencies should employ a narrower i-f. The bandwidths obtainable are reducible to values below 10 cps.

Excessive selectivity increases the requisite sweep period because of the greater time constant associated with a smaller i-f bandwidth.

Following the last i-f amplifier is a peak detector using a diode-connected 6SL7 to convert the variable amplitude i-f envelopes into a proportionate d-c level to drive the push-pull vertical deflection amplifiers, V_{8B} and V_{12A} . The single line presentation or response curves represents no particular problem when demodulation is effected at an r-f intermediate frequency.

Triangular-Wave Generator

The use of a variable-speed-scan symmetrical triangular waveform is almost mandatory for precise measurements at rates which are commensurable with a-f transient periods. Since the delays are always in the direction of the scan, the bidirectional linear mode shows a dual trace when the rate is excessive. Adjusting the sweep-rate frequency down-

ward until virtual superimposition of the two responses is obtained, assures the fastest writing rate consistent with accuracy.

The triangular-wave generator shown in Fig. 4 is designed so the output amplitude is the critical parameter in switching between two stable states in a trigger circuit. Line size and sweep width are thus maintained constant with sweep rate.

Hysteresis

Operation of the 12AX7 trigger stage depends upon hysteresis effect in a multivibrator. If the plate voltage of the 12AT7 Miller integrator is rising, feedback level at the control grid of the 12AX7 will rise proportionately. At the critical level, the driven section of the 12AX7 will be turned on, lowering its plate voltage.

The second section grid voltage is lowered causing the second section to conduct less, lowering the cathode potential and causing a rapid regenerative action. The second plate level assumes the cutoff value near the supply voltage of 250 v. this tends to raise the grid voltage of the integrator. The integrator characteristic is such that the final value of plate and grid voltage is approached exponentially.

The integrator plate voltage drops therefore to approach the quiescent level determined by the impressed grid voltage. In a small fraction of the equivalent time constant the lower level on the trigger circuit reaches the cutoff point thus reversing the action. The output waveform is linear because only the initial section of the charging curve is used.

The slope equalizer control serves to set the average bias so that the two values of V_i are equidistant from their respective initial voltages. It is set visually by adjusting the 100,000 ohm potentiometer for equal forward and reverse rates as seen in Fig. 5.

With the charging capacitors indicated, the scan rates are variable between 60 a sec and one in 25 sec with no change in line size. With low-leakage capacitors the periods have been increased to 15 minutes. Measurements have been made on dynamic shaker systems in which mechanical resonances were so selective as to require several minutes of scan even at a reduced sweep width when the sweeper was used to excite the armature power amplifier. These automatic sweeping techniques are in use for setting driving-point equalization networks in the random vibration systems specified for airborne structures.

Operation

The analyzer cro presentation shown in Fig. 6A indicates that the horizontal axis contains both logarithmic and linear frequency scales. The former is read on the lower portion of the screen and is intended for rapid overall surveys of many octaves (40 cps to 20 kc).

Figure 6B and 6C show that by increasing gain so the bandpass of the tested network exceeds full-scale deflection by an amount set by front panel calibrated attenuators, band-stop regions may be precisely examined down to attenuations exceeding 100 db. This range is limited by spurious components contained within the bandpass of the analyzer i-f.

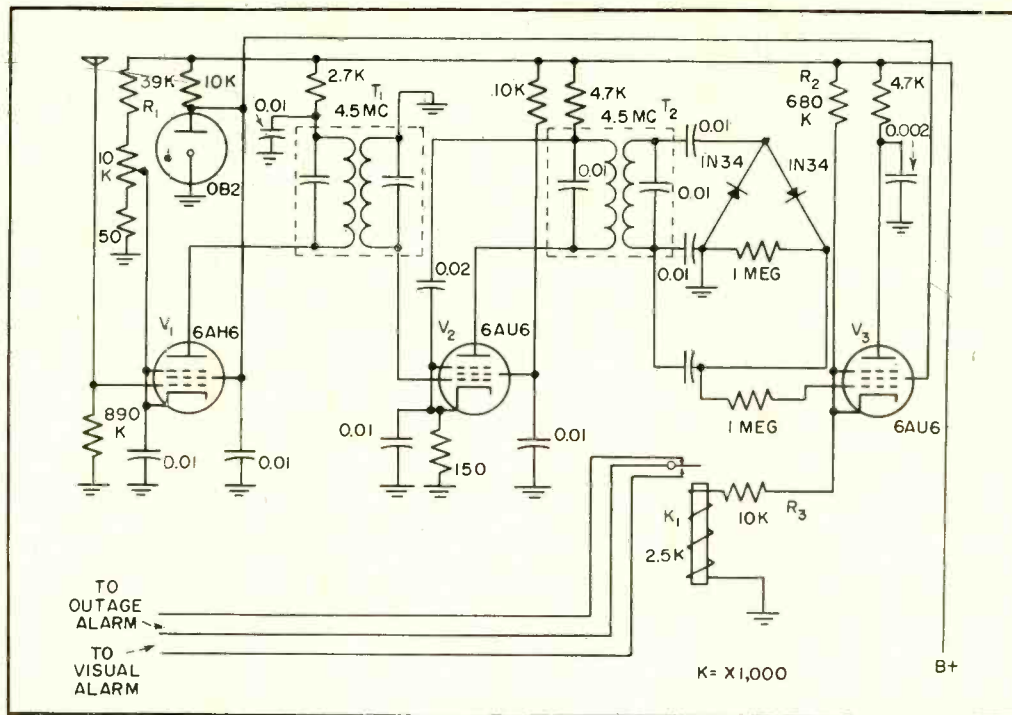

Circuit diagram of the heterodyne detector with power supply omitted for simplicity

INTERCARRIER FAILURE RINGS ALARM

SUMMARY — Receiver detects beats between picture carrier and sound carrier displaced 4.5 mc from it. Failure of either or both carriers resulting in absence of intercarrier frequency sounds alarm and starts outage recorder

By **KENNETH ATWOOD***

Instructor
Electrical Engineering Dept.
University of Utah
Salt Lake City, Utah

ACCURATE records of the time and duration of carrier failure at a tv transmitter are required by the Federal Communications Commission. The device described below will obtain this information automatically. An alarm or signal light can also be actuated to warn of failure.

The carriers of picture and sound transmitters that comprise the complete tv transmitter have a separation in frequency of 4.5 mc. At KSL-TV there are two separate

* Work done while author was employed at KSL-TV

tv transmitters—one for standby service. Such an arrangement gives four possible combinations of picture and sound transmitters. A device was desirable that would be as simple as possible and yet work with any pair of transmitters.

Two-Signal Device

The circuit used works on the superheterodyne principle with the two transmitters acting as the two oscillators. Signals from the two carriers are applied to the grid of V_1 . This tube is a remote cutoff type, so the gain of this stage is controlled by the setting of R_1 , which adjusts the bias. Since V_1 has a nonlinear characteristic, especially if driven past cutoff, the

two signals are mixed in it.

The output of V_1 is fed to T_1 , which is tuned to the frequency difference of the two signals. This 4.5-mc signal is further amplified by V_2 . Output from V_2 is fed through the tuned circuit T_2 to the detector. The detector consists of two crystal diodes connected in a voltage-doubling circuit.

The voltage-regulator tube controls the voltage applied to the screen grids of V_1 and V_2 . The pentode cutoff characteristics are sharper if the screen grid is maintained at a constant value.

Tube V_3 is biased to cutoff through the voltage divider action of R_2 , R_3 and the coil of K_1 . A current of about 0.4 ma flows through

K_1 , when V_3 is cut off. When a signal is applied to the detector, a positive voltage is produced that raises the voltage on the grid of V_3 to a conducting state. With V_3 conducting, the current through the relay coil is increased to 2.4 ma or more, depending on the strength of 4.5-mc signal received. The relay closes.

The power supply is a conventional choke-input type to keep the B + voltage down to about 200 v.

Signal Failure

If either carrier drops out, no 4.5-mc signal is produced and V_3 is cut off. Relay K_1 opens. Loss of a tube or a blown fuse will also allow the relay to open. The circuit will thus give an alarm if part of the circuit itself fails. An outage clock unit is available that gives the time outage occurred and the duration of the outage. This unit must be actuated through the relay contacts by an outside source. The relay is also used to actuate a light circuit or an aural signal such as a bell.

Since the monitor unit is used at the transmitter site a strong signal is available to feed it. A simple half-wave antenna tuned to the tv carrier picks up plenty of voltage to actuate the circuit. An inside antenna was tried first, but in the steel building where this transmitter is located, a great variation of signal strength was found as the antenna was moved.

The strength at any one place was found to vary with sound modulation or with the movement of a person near the antenna. This effect was undoubtedly caused by changes of the standing-wave pattern with changes of the sound frequency or the placement of obstacles to the waves.

When an outside antenna was used, a good strong signal was available. Input impedance to the unit is high and a great mismatch to the antenna will result. This mismatch need not be bothersome if the transmission line is cut to a length such that maximum voltage is observed at the input to the unit.

Tuning the circuit can be accomplished by placing a vacuum-tube voltmeter across the detector and tuning for maximum direct voltage out with both transmitters on.

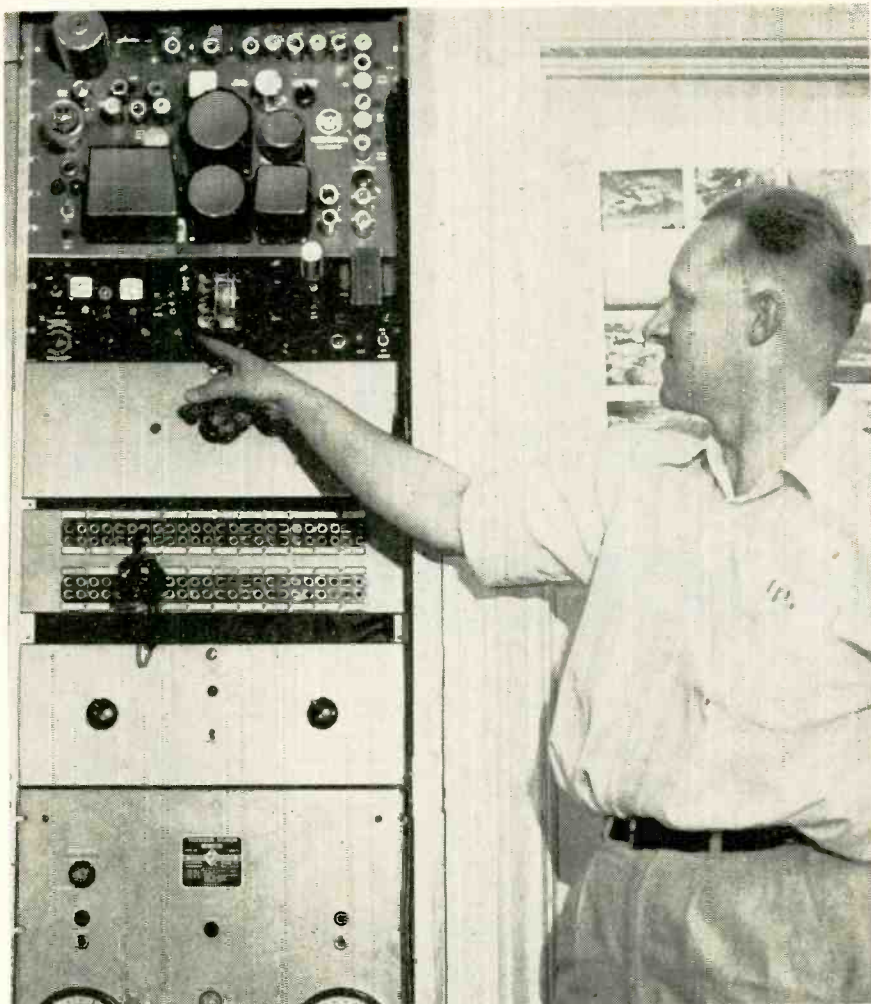

Failure of picture or sound carrier is detected by unit mounted in cabinet with other tv transmitter monitoring equipment

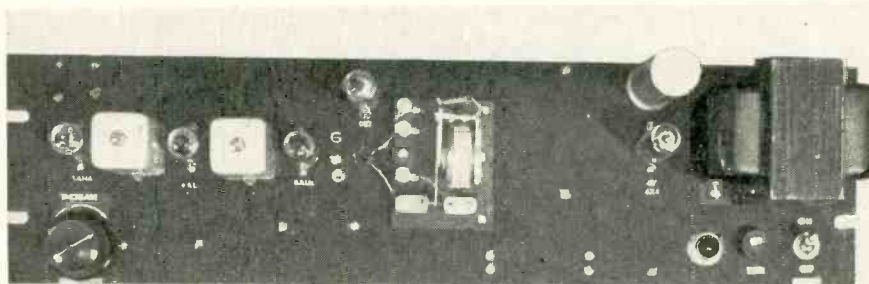

Sensitivity control (left) adjusts operation of relay device (center). Power supply is at right

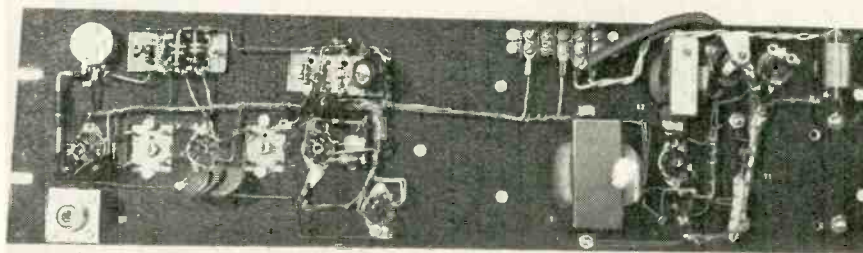

Reverse of panel shows mounting of r-f components (left). Remainder of power supply components (right)

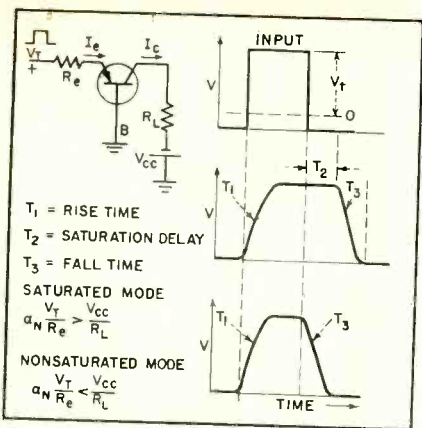

FIG. 1—Response time with storage delay (middle curve) and no delay (lower curve)

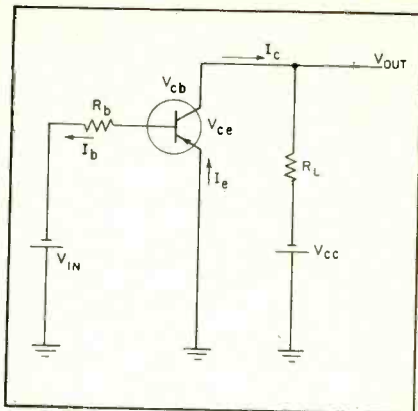

FIG. 2—Back-clamping technique giving voltage gain along with good efficiency

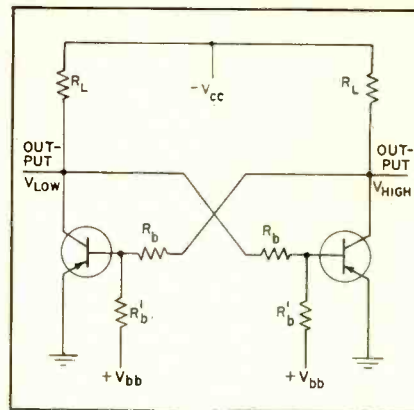

FIG. 3—Bistable saturated circuit is less efficient at low output power

BOOSTING TRANSISTOR

By RICHARD H. BAKER

Staff Member
Massachusetts Institute of Technology
Lincoln Laboratory, Cambridge, Mass.

SUMMARY — Transistor properties affecting response time in switching circuits are summarized and basic circuits given for obtaining maximum energy conversion efficiency. Combined use of pnp and npn transistors gives circuit symmetry that utilizes inherent advantages of transistors. Other circuits include saturated and nonsaturated current-demand flip-flops with single or double triggering, designed for maximum reliability despite normal variations in circuit constants and input pulses

THE NORMAL three-region junction transistor (excluding graded-base or drift types) is a slow device when compared to a vacuum-tube triode. In a tube, the movement of electrons from cathode to plate is aided by strong electric fields, whereas in a transistor the transport of carriers (electrons or holes) is only by diffusion.

In designing transistor circuits for high-speed switching, the designer must consider normal integrative effects due to shunt capacitances as well as the delay or carrier transit time between emitter and collector. When the transistor is operated in the saturated mode, there exists an additional effect,

that of hole storage or saturation delay.

Response Times

There may be as many as three separate response times, depending upon the mode of operation, associated with a single-stage transistor network. These are rise time, storage or saturation delay and fall time, all shown in Fig. 1. If R_L , R_e , V_{cc} and V_T are chosen so that the voltage polarity across the collector junction maintains the collector junction under reverse bias at the peak of the output pulse, the saturation delay vanishes.

The magnitudes of response times T_1 , T_2 and T_3 are different for each of the three basic connec-

tions. In all modes of operation, however, the transistor switching time is dependent on the constants of the device and the amount of overdrive supplied at the input.

The single most important factor affecting the switching time is the frequency response of the device itself. Also, minimum response time occurs when current gain a_N is 1.

There is promise of obtaining high-frequency transistors by using graded-base structures and other configurations. However, the interim solution of transistor manufacturers has been to build transistors with very narrow base widths to increase the frequency response. This approach is fruitful to a degree, but there is an op-

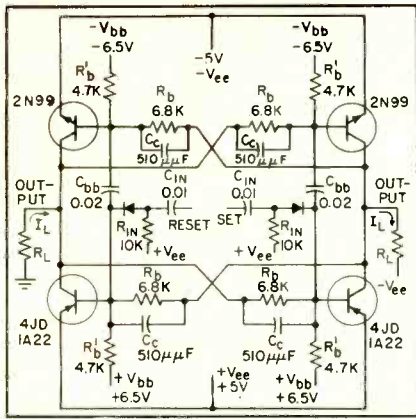

FIG. 4—Saturated current-demand single-triggering circuit with 1-mc transistors

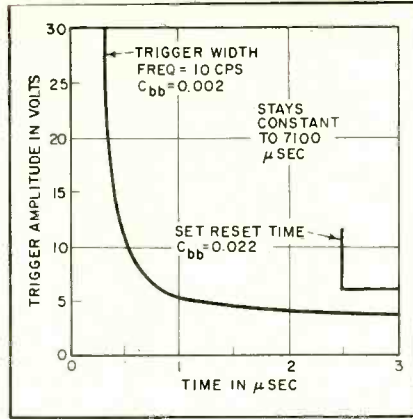

FIG. 5—Characteristics of single-triggering circuit of Fig. 4

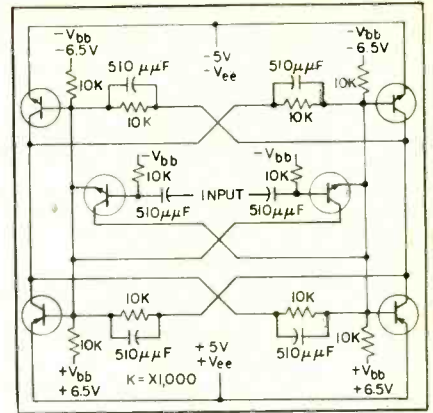

FIG. 6—Saturated current-demand flip-flop double-triggering with 1-mc transistors

SWITCHING SPEED

timum base width that yields minimum switching time for practical switching circuits. This optimum base width is generally different for each of the three basic connections.

In transistor circuits the transit time of the carrier across the base region imposes an absolute minimum input pulse width. This in turn sets rather large minimum capacitance values in a given circuit, creating recovery time problems that may be more serious than actual rise time considerations.

Signal Levels

Because transistors are extremely efficient voltage-wise, the system levels are usually set by a combination of system and transistor considerations.

The low voltage limit is automatically set if the transistors are allowed to saturate, this being primarily determined by speed considerations.

The upper voltage limit is set by the total power consumption of the system and by the punch-through and avalanche phenomena in the transistor.

The signal voltage swing in an all-transistor system is usually chosen as a compromise between

two inherent opposing effects. As the signal level increases (total swing), the amount of energy dissipated in charging and discharging capacitance increases. This effect indicates that the signal level should be low. On the other hand, for convenience of circuit design the signal level should be large

compared with the transistor off-on uncertainty region, which is about 0.2 volt for germanium transistors and about 1 volt for silicon transistors.

Energy Conversion Efficiency

Fundamentally the transistor, like the vacuum tube, has gain by virtue of dissipation changes. Unlike the vacuum tube, the input impedance is much lower than the output impedance. In the design of realistic transistor systems, then, a serious problem arises in the available power to drive succeeding stages. This situation is aggravated still further in the design of high-speed systems, since it is necessary in the transient state to overdrive the stages to obtain fast switching. This fact, more than any other, accounts for the large number of transistors required to build transistor systems compared with equivalent vacuum-tube systems.

These considerations indicate that circuitry should be designed to deliver maximum output power and that a high percentage of the available output power should be available to drive other transistors. Further, since currently available high-frequency transistors are ex-

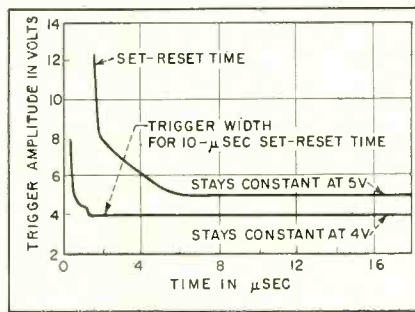

FIG. 7—Characteristics of double-triggering circuit of Fig. 6

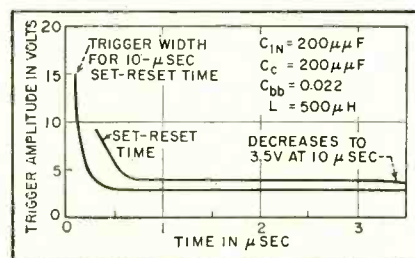

FIG. 8—Characteristics of double-triggering circuit using 5-mc transistors

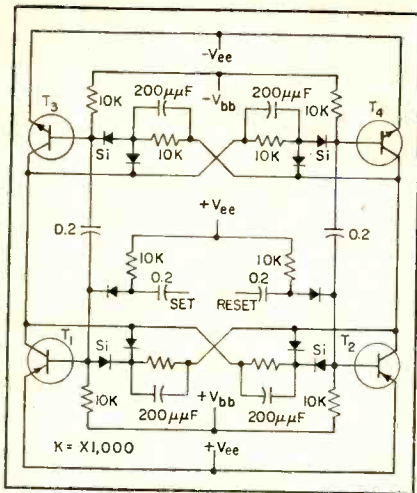

FIG. 9—Nonsaturated current-demand single-triggering flip-flop

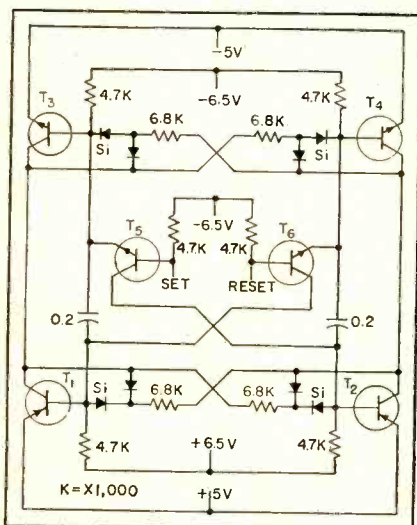

FIG. 10—High-speed nonsaturated current-demand double-triggering flip-flop

extremely low-power devices (on the order of 0.5 mc-watt as a figure of merit for SBT-100 at 50 mc and 10 mw), circuitry should be designed to give highest possible energy conversion efficiency. The ratio n_1 of useful signal output power to transistor dissipation should therefore approach infinity.

For optimum circuit design of a minimum-power-drain system, the ratio n_2 of useful signal output power to power supply drain should approach 1.

The product of n_1 and n_2 should be made as large as possible. The ratio represented by n_1 can be made large by allowing the transistor to saturate or by controlling the voltage from collector to base through the use of clamping diodes. However, minimum-power systems can be built only by making n_2 close to

unity (this must be true if there exists a minimum power level to process intelligence).

In most present transistor circuit designs, a high percentage of useful output power from the transistor is dissipated in the load resistors. This is especially true for direct-coupled logic. Therefore, the value of n_2 may be increased significantly by removing the standby power dissipated in this area.

The circuit design techniques in the following sections show how the values of n_1 and n_2 may be increased to give minimum power dissipation, maximum speed and minimum sensitivity to component and transistor drift circuits.

Maximum-Efficiency Circuits

Aside from eliminating the power dissipated in load resistors, an additional gain in system power efficiency may be obtained by using circuits that draw power from the supplies according to the power and demand at the output. This process always involves feedback. Cathode-follower and emitter-follower (grounded-collector) circuits do this, but unfortunately have no voltage gain.

A transistor circuit involving voltage gain, along with an ability to convert d-c power into signal power as required by the load, is shown in Fig. 2. The transistor dissipation is low and the output power is high for collector currents less than the maximum output current. The major portion of the power drawn from the supplies is available at the output for dissipation in the load resistor, so that n_2 approaches 1 and the circuit draws from the supplies only the power dissipated in R_L and R_b (neglecting transistor dissipation). The only transistor parameter of importance in the conducting state is the minimum base-to-collector current gain β_V .

To illustrate the design of this circuit, assume that β_V is 20, input d-c voltage V_{in} is 5 volts, transistor saturated base resistance r_b is 50 ohms, V_{cc} is 10 volts, R_b is 10,000 ohms and R_L is 1,000 ohms. Then I_b is about 0.5 ma, $I_{c,max}$ is 10 ma and I_c is the sum of these or 10.5 ma. Useful signal output power is $\frac{1}{2} V_{cc} I_c$ or 50 mw and transistor dissipation is 10.5×0.2 mw, so

that n_1 is about 24. Power supply drain is 50 mw + 2.5 mw, so that n_2 is about 0.95.

Two of the circuits of Fig. 2 may be coupled together, with only slight modification, to form the bistable circuit of Fig. 3. This has several drawbacks, however. The low-voltage level is not fixed, being dependent on I_{c0} and other factors. The power dissipated in internal load resistor R_L (in shunt with the actual load) may be an appreciable percentage, particularly at low output power levels. For fast fall time (when the transistor is turned off), R_L must be made small.

Current-Demand Circuit

A circuit that circumvents these disadvantages is shown in Fig. 4. Here essentially all of the output current (collector current) is available to drive load R_L .

Standby power is low; when there is no load, the power taken from the supplies is approximately equal to the dissipation $2 I_b R_b$ in the base resistors. Both the high and low voltages are clamped (the transistors saturate). The

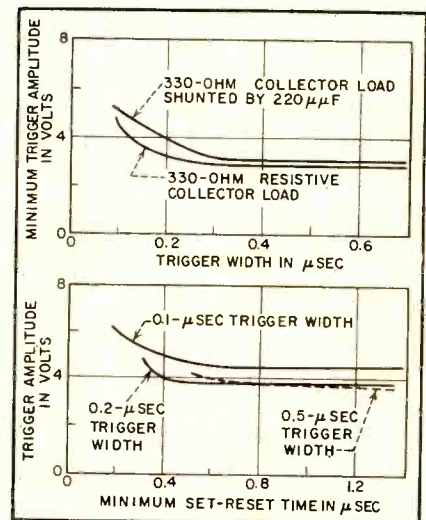

FIG. 11—Triggering characteristics of flip-flop of Fig. 10

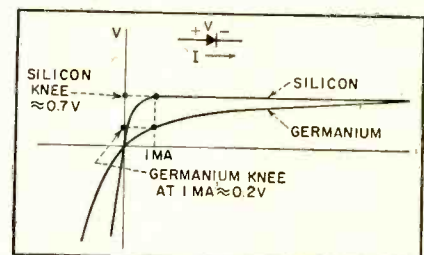

FIG. 12—Diode characteristic curves

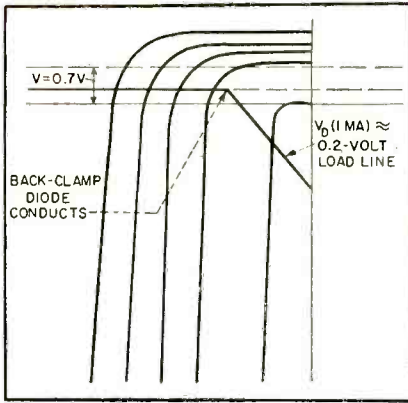

FIG. 13—Family of collector curves for silicon transistor

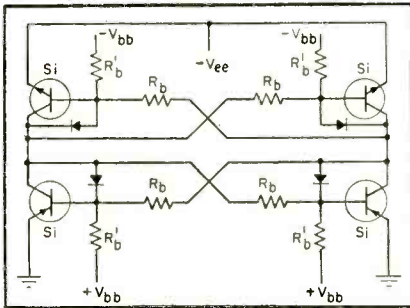

FIG. 14—Basic silicon transistor circuit for nonsaturated current-demand flip-flop

tolerance on all resistors may be large (on the order of 50 percent).

Circuit operation is substantially independent of transistor parameters. The stability of the configuration is insensitive to supply voltages. The configuration leads to fast rise and fall time since large transistor overdrive is inherent. The last three advantages accrue because the configuration allows the transistors to set their own levels. Some of the operating characteristics of the circuit are shown in Fig. 5.

One difficulty with the circuit of Fig. 4 is that there is an appreciable delay around the loop because the conducting transistors are saturated. This difficulty may be minimized by double triggering (triggering all four transistors simultaneously). The current-demand flip-flop circuit of Fig. 6, employing this feature, gives the characteristics shown in Fig. 7. By using 5-mc transistors in this circuit and changing all 510- $\mu\mu\text{f}$ capacitors to 200 $\mu\mu\text{f}$, the characteristics of Fig. 8 can be obtained.

The circuit techniques described may be extended to nonsaturating circuits. The primary gain in de-

signing the circuits to operate in the nonsaturating mode is decreased switching time. Figure 9 shows a typical design using the nonsaturated configuration with single triggering. Figure 10 shows a higher-speed version using double triggering, and Fig. 11 gives triggering conditions for the circuit. The diode characteristics in Fig. 12 show why these back-clamped circuits do not allow the transistors to be saturated.

If silicon transistors are used, the nonsaturated circuits do not require the four silicon diodes. This may be seen from the silicon collector curves in Fig. 13. The basic circuit using silicon transistors is shown in Fig. 14.

The salient features of the saturated back-clamping current-demand technique are low transistor dissipation, high conversion efficiency, insensitivity to component and transistor parameters (standby load resistors not needed), insensitivity to voltage supply drift, maximum system efficiency (power drawn from supplies according to needs of load), fast rise and fall time (inherent overdrive) and loop delay (caused by saturation time). Nonsaturated circuits give increased operating speed because they have no saturation delay, but are otherwise identical.

Gating Circuits

The design of maximum-reliability switching systems depends heavily upon the reliability of the voltage-pulse voltage-level gate. To assure maximum system reliability (assure positive action and suppress superfluous triggering), the gate circuits should be independent of pulse width, pulse amplitude, pulse repetition frequency and pulse level (within given limits), and should have fast response to pulse and level changes. The circuit design should also be insensitive to component values and transistor parameters, require minimum standby power, have high output power, present a constant load to the pulse source (driver) and deliver standardized output pulse and level amplitudes.

A circuit configuration that fulfills to a high degree the above reliability characteristics is shown in

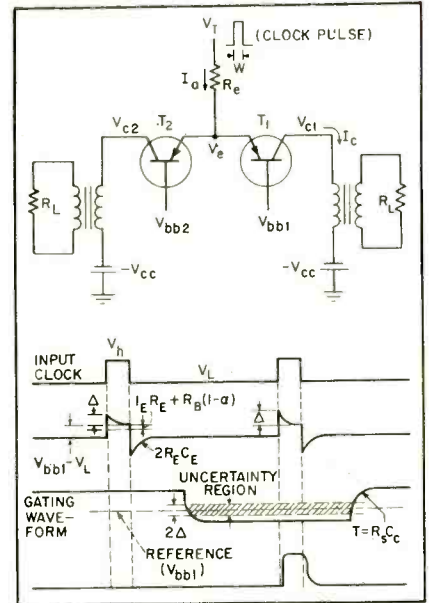

FIG. 15—Circuit and waveforms of pulse-level gating circuit

Fig. 15 along with its gating waveforms.

Conclusions

The reliability of transistor switching systems is closely related to the design of circuits. The circuit designer must consider the drift of operating points caused by aging and ambient self-generated temperature changes. For high-speed networks, due to the lack of high-speed transistors, overdrive must be used to speed up the circuit response.

Transistors are inherently efficient devices (both voltage-wise and power-wise). This, along with the fact that two types of transistors are available (*nnp* and *pnnp*), allows circuit design that is extremely efficient in terms of power supply drain for a given signal power output.

The transistor, being an efficient, reliable and small device, may be soldered into systems much as are ordinary resistors and capacitors. This, plus the fact that it is basically a three-terminal passive device which can produce power gain, makes its use attractive in networks where feedback techniques are widely employed.

The research work herein described was supported jointly by the Army, Navy and Air Force under contract with Massachusetts Institute of Technology.

Dual-Triode Tester

By RONALD L. IVES

Palo Alto, Calif.

SUMMARY — Zero-balance meter indicates the static and dynamic characteristics of any dual-triode, simplifying tube selection for critical requirements. Circuit uses difference-amplifier bridge with complex-wiring connections from pin-terminals of four tube sockets to a nine-deck selector switch. Meter is protected against overcurrent and alarm rejects bad tubes

INCREASING use of dual-triodes in modern equipment has made necessary use of tubes in which the two triodes are closely matched, statically, dynamically, or both. Selecting a dual-triode which is balanced within usable limits may be done quickly with the balance tester to be described.

Balance Requirements

Commercial equipment using balanced dual-triodes requires static and dynamic performance of the two triodes within a few percent. Allowable deviation depends upon a number of factors which may include the range and effectiveness of the compensating ad-

justments and the tolerance of the circuit components.

For many applications, only the static characteristics of the two triodes need be in balance. When the same plate and grid voltages are applied to both, the plate currents must be equal, plus or minus the predetermined allowable deviation.

For other applications, the dynamic characteristics of the two triodes must be in balance. When the same plate and grid voltages are applied to both, the plate currents must be equal, plus or minus the predetermined allowable deviation, when an a-c signal is applied to both grids. For most uses, the

frequency of this signal is unimportant and the amplitude is not critical, so long as it does not drive the grids positive on the positive half cycle, or cut the tube off on the negative half cycle.

Difference Amplifier

The ideal circuit for determining the degree of unbalance of the two halves of a dual-triode is the well-known difference-amplifier, the thermionic element being the tube under test. If the two triodes are identical in performance, the meter will read zero. If they are not identical, the meter reading will give a measure of the unbalance.

Because this is effectively a bridge circuit, null position, which corresponds to perfect balance of the two triodes, is unaffected by changes in line voltage or in supply-current waveform.

Conversion Circuit

Conversion of the basic difference-amplifier circuit into an effective dual-triode balance-checker requires a power supply, a switching system to accommodate the fifty or more dual-triodes now in use, and safety devices to protect the meter against the effects of possible defective tubes. The circuit used, minus the switching sequence, comprises Fig. 1.

The switching system consists of a nine-deck selector switch wired to the terminals of the tube sockets-connections. The internal wiring, from each of the nine decks of the selector-switch, to the pin-

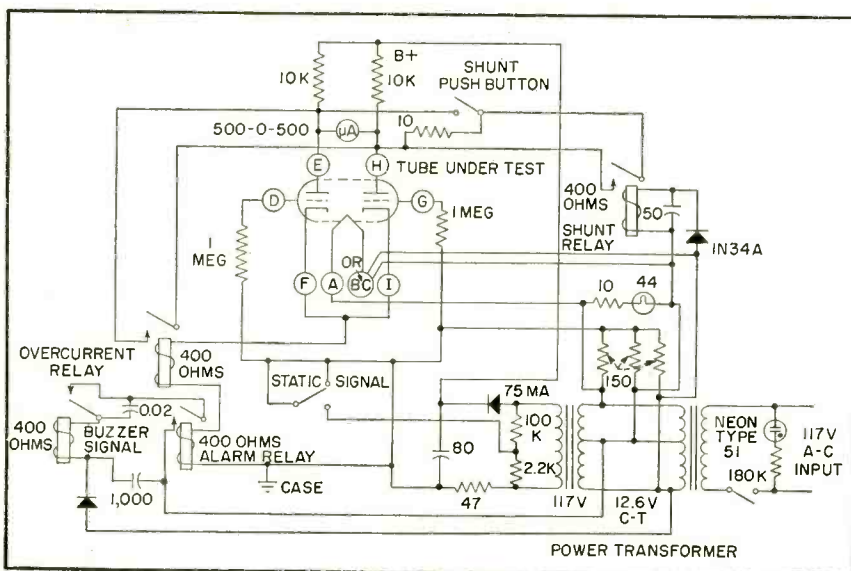

FIG. 1—Dual-triode test-balance circuit. Letters A through I designate connections to each level of a nine-deck selector switch. Pin-terminal connections for each tube are given in Table I. Relays protect the meter

Measures Tube Balance

Table I—Switching Sequence of Balance Tester

FILAMENT VOLTS		6	12	6	6	12	6	12	6	12	12	12
RETMA SOCKET DIAGRAM		8	8	8	8	8	7	8	8	8	8	9
		8D	8D	8B	8S	8S	7F	8F	8F	8F	8F	9A
SELECTOR SWITCH POSITION												
SWITCH LEVEL	FUNCTION	1	2	3	4	5	6	7	8	9	10	11
A	H COM	7	7	7	7	7	3	1	1	2	2	4
B	6V H	8	-	2	8	-	4	8	-	7	-	5
C	12V H	-	8	-	-	8	-	-	8	-	7	-
D	GRID 1	1	1	4	3	3	6	4	4	1	1	2
E	PLATE 1	2	2	3	2	2	1	3	3	3	3	1
F	CATH 1	3	3	8	6	6	7	2	2	4	4	3
G	GRID 2	4	4	5	4	4	5	5	5	8	8	7
H	PLATE 2	5	5	6	5	5	2	6	6	6	6	6
I	CATH 2	6	6	8	6	6	7	7	7	5	5	8
SOCKET		OCTAL			7	LOKAL			NOVAL			

terminals of the four tube-sockets is shown in Table I.

The RETMA socket designation for each dual-triode that may be tested indicates the selector-switch position and the numbers in the main column designate connections to sockets named at the bottom of the column. With this arrangement, all sockets except the one in use are electrically dead.

The power transformer consists of two 12.6-volt transformers connected back-to-back. This arrangement effectively isolates the B supply from the line while also supplying 6.3 and 12.6 volts for filament heating, as well as auxiliary voltages for other uses.

A signal of slightly less than 3 volts a-c is available from a resistive tapoff from the B supply transformer winding. Plate and grid resistors for the difference-amplifier are matched within 0.1 percent.

Relays used in the safety devices are Price radiosonde relays, with a nominal resistance of 400 ohms and a sensitivity of about 8 milliamperes.

Meter Protection

So that vibration and jarring incident to moving will have a minimum effect on the meter, it is

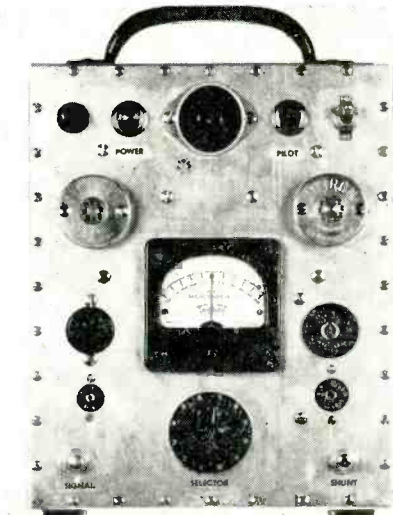

Sockets are on both sides of the meter and selector switch and under a pair of pin-straighteners

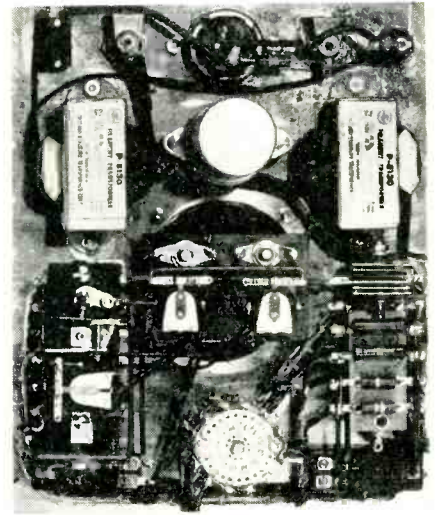

Wiring-connections are made to the nine-deck selector switch, shown at bottom center. Construction is relatively simple

shorted by relay contacts when the power is turned off.

To protect the meter against the sometimes extreme warm-up surges occurring in some dual-triodes, even though they may be balanced when fully warmed up, a shunt resistance is connected across the meter movement through a push button.

Gassy tubes and those with one triode shorted sometimes produce heavy cathode currents on one side only. These may damage the meter and indicate that the tube should be discarded immediately. Meter protection and indication of heavy cathode currents, is provided by a pair of 400-ohm relays connected in series in the common-cathode circuit. The overcurrent relay in Fig. 1 shorts the meter, effectively protecting it against any asymmetrical overcurrent likely to occur in the system. The alarm relay actuates a small high-frequency buzzer, which is fed from a rectifier-filter supply powered by the filament circuit. This prevents confusing a bad tube from one with perfect symmetry. As the meter reading for a perfectly balanced tube is the same as the reading when the meter is shorted, a bad-tube alarm is necessary.

After power connections have

been made, the tube to be tested is inserted in the appropriate socket on the front panel. The selector switch is then dialed to switch position determined by the RETMA socket designation of the tube.

After a two minute warm-up, the shunt button is pressed and the meter reading is noted. If this is within allowable limits for the projected use, the signal button is pressed and the reading is again noted. If the tube is within allowable limits, it is used, if not it is returned to stock for use in a non-critical position.

Performance

Use of this instrument in a laboratory devoted to research and servicing of critical equipment discloses that its performance is satisfactory, electrically and economically. Balanced dual-triodes for use in d-c and a-f equipment can be selected by its use with substantially 100-percent assurance that they will operate in the equipment.

At 10 megacycles, approximately 90 percent of the tubes that test good for balance will work in the equipment. At 100 megacycles, the percentage falls to 80, due in large part to capacitance unbalance which are not disclosed by the balance testing method.

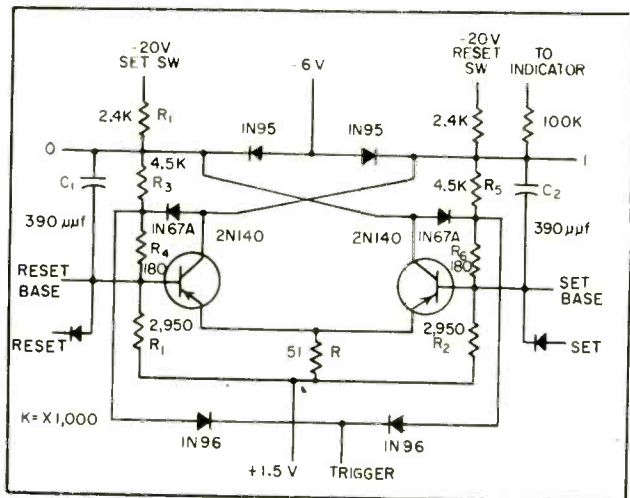

FIG. 1—Flip-flop stage has saturation operation of transistors

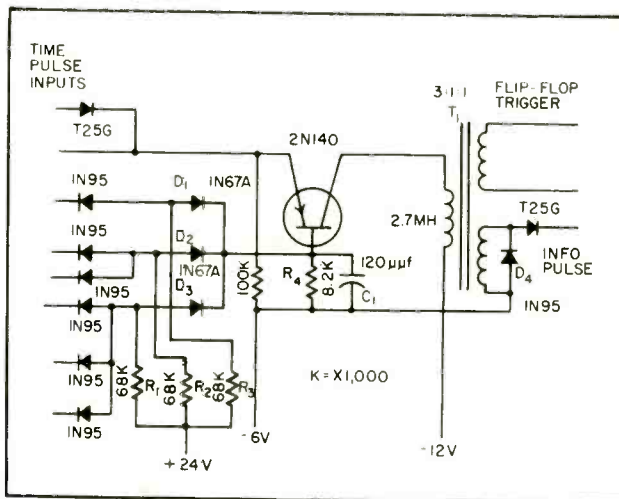

FIG. 2—Gated pulse amplifier has 250-kc repetition frequency

Basic Logic Circuits for

SUMMARY — Digital computer circuits, including flip-flop, gated pulse amplifier, d-c amplifier, power amplifier and indicator, use high-frequency junction transistors to obtain high reliability and performance characteristics. Circuits operate over temperature range of -30 to $+60$ C; their low dissipation imposes minimum requirements on power supplies and cooling

By **G. W. BOOTH** and **T. P. BOTHWELL**

*Radio Corporation of America
Camden, New Jersey*

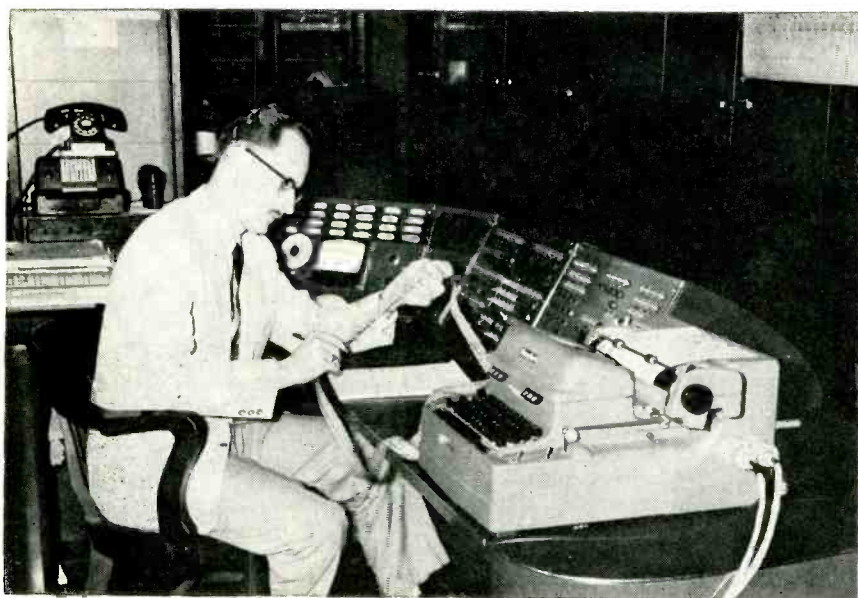

Operator reads out punched tape from RIFTE computer console. Transistor circuits are in rack seen in back of operator's head

ONE of the important properties of a digital computer is that it may be assembled simply and easily from a few well-chosen functional circuits. Each of these circuits represents a logical building block that is useful to the system or logic designer in planning a computer.

This article presents a group of transistor circuits for a general digital computer application.¹⁻⁴ The circuits described are the result of a conservative design approach which takes advantage of the high switching efficiencies obtainable with the alloy junction transistor. Precision resistors are used throughout, and are treated as five-percent resistors in the design. Power dissipation, current, and voltage levels are kept low in

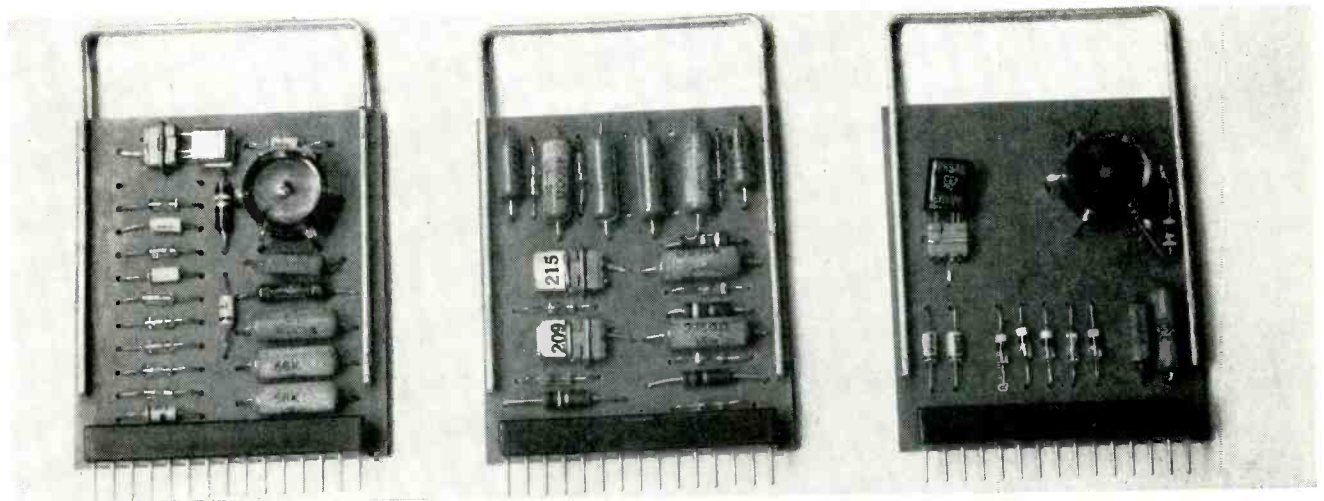

Gated pulse amplifier, flip-flop and power pulse amplifier circuits (left to right) are constructed on plug-in wiring boards

Computer Applications

diodes and transistors, yet are large enough to avoid serious problems resulting from noise pickup. Circuit dependence on individual parameters of the transistors is minimized. Commercially available high-frequency alloy-junction transistors are used and a considerable slump of transistor gain from specified values can be tolerated without sacrificing performance.

The two basic circuits are a flip-flop and a gated pulse amplifier. All information flows in the form of 0.5- μ sec pulses through chains of one or more gated pulse amplifiers and is ultimately stored in a flip-flop. Gate control information is in the form of d-c levels from flip-flops, in most cases without intermediate amplification being necessary.

Flip-Flop

The first of the basic circuits is a flip-flop. The Eccles-Jordan circuit shown in Fig. 1 was chosen for complementary outputs, its designability and the efficiency obtained by saturation operation of the transistors.

The limited frequency response available in alloy junction tran-

sistors requires clamping of the turn-off transient for fast rise times under load. Collector current in the flip-flop transistors is limited to 10 ma. A collector output swing of six volts was chosen as large compared to diode forward voltage drops, yet small compared to breakdown voltages of diodes and transistors.

A d-c stability analysis determined the circuit parameters to assure a two-ma load specification, stability under conditions of large I_{co} and discrimination against small noise pulses that would tend to trigger the circuit.⁶ Reverse bias on the base-emitter diode of the nonconducting transistor is guaranteed with allowances for I_{co} and leakage in diodes of at least 120 μ a, which corresponds to the I_{co} that might be encountered at +60 C. Since this figure is based on tolerance extremes of all components, a considerably greater I_{co} can generally be tolerated.

The design assures saturation in the on transistor for worst cases of all resistor and supply voltage tolerances for transistors with large-signal current gains greater than 15 at the 10-ma collector current required for flip-flop operation. No

maximum gain figure need be specified.

Switching Speed

At the instant the conducting transistor turns off, its collector rises toward some potential which is less than the supply voltage. In a flip-flop of this type, the aiming potential should be at least as large as the clamp voltage since the d-c stability analysis is based on a collector voltage equal to the clamp voltage.

Aiming Potential

The aiming potential is defined as the resultant potential at the cut off collector due to the divider action of the collector resistor, the feedback resistor and the load resistor when the clamp diode is disconnected. However, to assure that worthwhile advantage in speed is obtained, the aiming potential-to-clamp voltage ratio must be somewhat greater than unity. For Fig. 1, with a two-ma load current, this ratio is 1:5.

Feedback capacitors C_1 and C_2 were chosen empirically to perform speedup and memory functions for a typical pair of transistors. Too large a capacitance results in slow

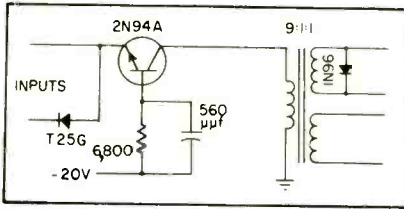

FIG. 3—Power pulse amplifier provides 180-mw output for 30-mw input

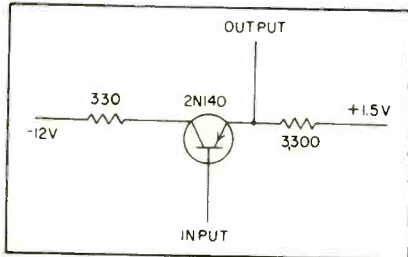

FIG. 4—Emitter follower provides current gain with nearly unity voltage gain

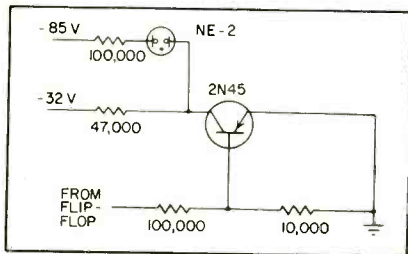

FIG. 5—Biased neon-lamp indicator

switching at the cut-off collector. Too small a capacitance results in tight frequency response requirements on the transistors for a satisfactory range of trigger pulse voltage and width. A compromise in the vicinity of 400 μmf provides a feedback coupling which is relatively independent of transistor characteristics.

To achieve a high repetition rate for the flip-flop, the discharge time constant τ of the feedback capacitors should be as small as possible. This time constant is given by

$$\tau = C_f [R_b R_f / (R_b + R_f)]$$

where C_f is C_1 or C_2 , R_b is R_1 or R_2 , and R_f is $(R_3 + R_1)$ ($R_3 + R_2$).

Capacitor C_f must be increased as R_f is reduced; R_f is largely determined by current levels in the circuit. Thus, for minimum resolution time, it is desirable to have R_b as small as practicable.

Common emitter resistor R_e is included to obviate the need for a small bias supply voltage. With R_b small, the bias potential to which R_e is returned must be small to

maintain an adequate current in the base of the conducting transistor. Such small bias voltages are both difficult and inconvenient to generate and regulate.

For this purpose, a bias is generated by the saturation current of the on transistor through R_e . The emitter return is set at +1.5 v so the collector of the conducting transistor is assured to be positive with respect to ground, providing a reverse bias on ground-returned loads.

Saturation Effects

Pulse steering is incorporated into the circuit to reduce saturation effects of the turn-on trigger pulse at large trigger amplitudes. A feedback diode from each collector to a tap on the feedback resistor provides a shunt path from this base tap to the collector of the conducting transistor.⁶ Hence, a large amplitude trigger does not cause a high degree of saturation in the conducting transistor.

On the cutoff transistor, the feedback diode is reverse biased by six volts and has no effect on circuit operation. This feedback diode does not assure nonsaturating operation of the transistor, since some fixed current will flow through the resistor between feedback diode and base for the essentially constant forward bias drop of the diode.

For a high-gain transistor, this fixed current may represent saturation; for a low gain transistor, it may not. However, if the gain of the conducting transistor is sufficiently low as to cause it to be out of saturation by more than a few tenths of a volt, the feedback diode cuts off, providing maximum base current to the conducting transistor. In any case, d-c stability is not sacrificed by the use of the

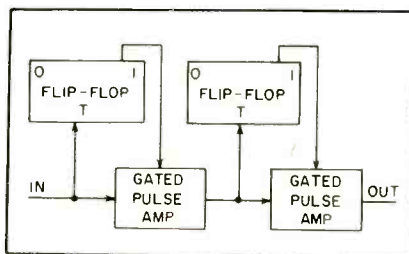

FIG. 6—Two stages of binary counter with high-speed carry

Table I—Output Specifications

Circuit	Output	
	Form	Maximum Load
Gated Pulse Amp	2.6-v pulse 1/2 μsec (10 ma)	2—F-F or 3—GPA or 1—PPA
Power Pulse Amp	2.6-v pulse 1/2 μsec (55 ma)	11 F-F or 17 GPA or 7 PPA
Flip-Flop	6-v level (2 ma)	4 GPA or 2 EF } + 1 Ind
Emitter Follower	6-v level (18 ma)	36 GPA

feedback diodes in the circuit.

For the circuit of Fig. 1, a trigger-amplitude range of 2.1 to 4.5 v was obtained for a resolution time of 1.2 μsec . Operation with a trigger pulse width from 0.4 to 0.9 μsec at the 2.6-v nominal pulse amplitude was achieved.

Gated Pulse Amplifier

The second basic logic circuit is the gated pulse amplifier shown in Fig. 2. The gating function of the circuit is controlled by the or-and diode gate in the base lead of the transistor.

Each or input of this gate is derived from a flip-flop whose output is 0 or -6 v. A 2.6-v positive pulse, biased at -6 v, is applied at the emitter. A pulse output will appear only if the base potential is more negative than -3.4 v since, if this condition is not met, the base emitter diode will never be forward biased. This condition can only exist when all and inputs have at least one or input at -6 v.

If one and input is at ground, the voltage division between its associated resistor R_1 , R_2 or R_3 , and R_4 will raise the base to -3 v. More than one and input at ground will make the base even more positive.

When the gated pulse amplifier is primed D_1 , D_2 and D_3 are cut off. Hence the diode gate may be neglected and the pulse amplifying qualities of the transistor amplifier alone considered. The transistor is driven from zero bias to saturation by the 0.5- μsec pulse applied at the emitter.

Capacitor C_1 offers an increase in effective frequency response by

allowing the circuit to operate as grounded base during the 0.1 μ sec turn-on and turn-off periods of the transistor. During the rise of the pulse, the transient current in the base lead is determined by the size of C_1 and the low pulse source impedance in series with the transistor base and emitter resistances. During the fall, the capacitor provides a low impedance in the base lead to diminish the effects of storage.

Each of these transient effects are settled in approximately 0.1 μ sec and have little effect on the circuit during the flat-top portion of the pulse. When the transistor is operating in saturation the voltage drop from emitter to collector is negligible and $\beta I_n > I_c$. In this condition, a constant voltage appears across the load and the magnetizing current in the output transformer increases linearly.

The pulse output will collapse if βI_n becomes less than I_c or if the pulse falls at the input. The primary inductance of T_1 is chosen to assure that the second of these two conditions determines pulse width. Either case will cause a high collector impedance to be presented to the load.

Diode D_1 provides a low resistance path to damp the overshoot of the transformer at the end of the pulse.

The circuit design allows for a 250-kc pulse repetition frequency.

Amplifiers

Two amplifiers complete the system, one a power pulse amplifier and the other type is a d-c amplifier.

The power pulse amplifier is basically similar to the gated pulse amplifier, with the exception that no gating bias is provided and a 2N94A *npn* transistor is used to obtain a high power output. For a given emitter current, power output is proportional to collector voltage and maximum collector voltage on the available *npn* was higher than on the available *pn*p's. This amplifier, shown in Fig. 3 is capable of providing a 180-mw pulse output for a 30-mw pulse input.

The d-c amplifier, shown in Fig. 4, is an emitter follower, providing current gain with nearly unity

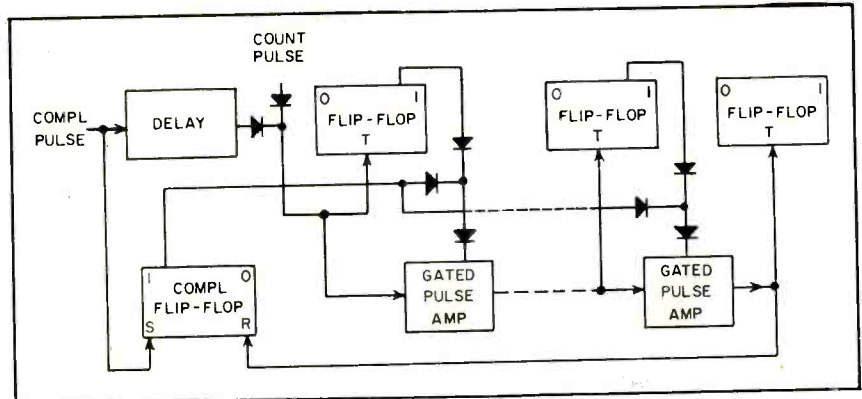

FIG. 7—Binary counter modification allows complementation and reversible counting

voltage gain. To prevent excessive dissipation and to avoid saturation in the transistor, a collector load resistor was introduced. Maximum transistor dissipation was calculated to be 40 mw and maximum load current 18 ma.

Indicator

Although not necessary to the logic, an indicator is desirable for any test of the system and for trouble shooting. The indicator shown in Fig. 5 employs a biased neon tube which is switched off and on by an a-f transistor. The transistor requirements are modest—collector breakdown greater than 35 v and current gain greater than 10.

Dissipation in the transistors is negligible since only the on current of the neon lamp need be supplied. Neon tube requirements are more strict because extinguishing potential is about 55 v and firing potential about 85 v.

Transistor requirements for flip-flop and gated pulse amplifier cir-

cuits are modest enough that 85 percent of the high-frequency transistors purchased in 1955 from one manufacturer were acceptable in all respects.

Rejects were primarily due to high leakage current at 20 v. Although the transistors were operable in the circuits, the low output impedance was taken as an indication of a poor junction, with adverse implications on long-term transistor life.

A suitable, currently available *pn*p is the 2N140; a *np*n is the 2N94A.

Complete specifications, formulated along with the test circuits to determine the specifications, are too lengthy to cover here. Three basic requirements are: 1) grounded-base frequency response > 4 mc; 2) large signal current gain (β) > 20 at $I_c = 10$ ma for flip-flops, > 30 at $I_c = 10$ ma for gated pulse amplifiers; 3) collector leakage and saturation currents (grounded base) I_{c0} at 6 v $\leq 3 \mu$ a, I_{c0} at 20 v $\leq 6 \mu$ a.

Application Rules

Table 1 summarizes the minimum output specifications for the circuits described.

Note that the gated pulse amplifier has two types of input, one requiring a 2.6-v, 3-ma, 0.5- μ sec pulse and the other requiring a 6-v, 0.5-ma level. Hence, the outputs of the gated pulse amplifier and power pulse amplifier can drive only the pulse inputs of a gated pulse amplifier.

The outputs of the flip-flop and emitter follower can drive only the level (diode gate) inputs of the gated pulse amplifier. The emitter

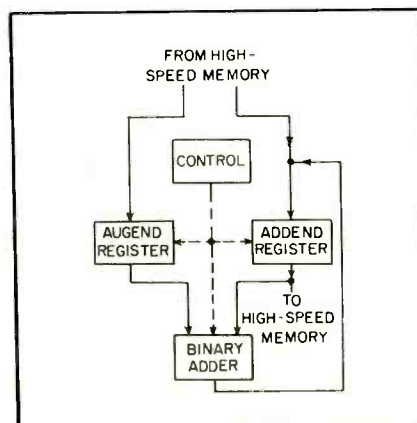
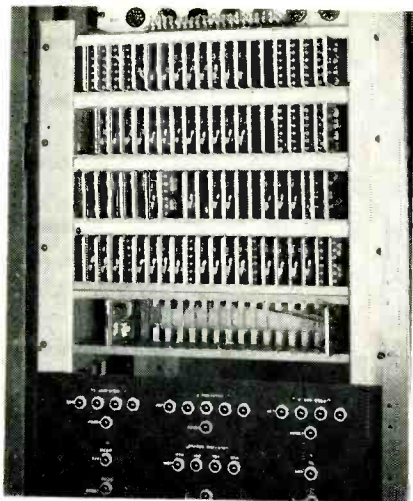

FIG. 8—Adder, excess-three-converter



Rack-mounted transistor adder-excess three converter uses plug-in boards

follower was designed to drive a maximum of 36 gated pulse amplifier inputs. This restriction is a matter of design convenience and not fundamental to the circuit.

Maximum pulse repetition frequency for the gated pulse amplifier is 250 kc. The flip-flop may be set and reset at a 500-kc rate; maximum triggering rate is 400 kilocycles.

Logic Techniques

The binary counter shown in Fig. 6 illustrates the type of logical structure to which the circuitry lends itself.

When a count is added to a binary counter, each bit is complemented according to the following two rules. Complement if: 1) the next least significant bit was one before addition of the count and 2) all less significant bits have been complemented under rule 1. The least significant bit is always complemented.

Hence, all bits of a counter are complemented starting from the least significant bit and continuing through the first bit in which a zero is found to be stored. This function is performed by the chain of gated pulse amplifiers in Fig. 6. The trigger pulse will pass from the first to the second stage and complement the second flip-flop only if the first flip-flop is in the one state before the trigger occurs.

Although the state of the flip-flop may change as a consequence of the pulse, the gated pulse am-

plifier acts on its initial state. This results from the relatively slow rise of the flip-flop to the -3 -v level required to affect the output of the diode gate.

Carry Time

Since the carry propagation of the counter is independent of the switching time of the flip-flop, fast carry ripple can be achieved. The circuit described here results in a $30\text{-}\mu\text{sec}$ carry-ripple time per stage. Hence in a 12-bit counter, the longest carry time will be $0.36\ \mu\text{sec}$. Time required for the result to be available is longer than this by the settling time of the flip-flop stages.

With very little additional equipment, the counter of Fig. 6 becomes a reversible counter. Figure 7 shows the logic for a simple version. Here the chain-gate logic performs both complementation and binary count. When subtraction from the original count is desired, the counter is complemented by the complement pulse and flip-flop, triggered with the count pulse, and recomplemented to be read.

Three characteristics of the counters shown might be highlighted for general computer logic applications: the pulse delay encountered through the gated pulse amplifier is small enough to allow a rather lengthy chain of amplifiers to be used with a minimum delay in passage through them; the gated pulse amplifier allows a wide variety of logic because of the or-and cascade and the ability to use these circuits in an interative connection; the relationship between the flip-flop resolution time and the pulse width allows the flip-flop to be sensed and changed in state with the same pulse.

Operating Experience

The proper test of circuits for digital computer use is their actual operation in a computer. There is available at RCA a general purpose computer specifically designed as a test facility. It has a high-speed random-access magnetic-core memory with a capacity of 1,024 seven-bit characters and uses a Flexowriter for input-output.

Using these transistor circuits, two components have been con-

structed for test in this machine. The first of these was a reversible counter and associated logic for keeping track of iterations during the multiply instruction and was built with a simple breadboard construction. Twenty-three transistors and 81 diodes were used.

Marriage between machine and transistor circuits was performed by a group of vacuum tube amplifiers, pulse shorteners, etc. The unit has operated without error for over 200 hours of computer operation. Routine testing of transistors during shutdown did indicate progressive deterioration of a group of transistors, all of one manufacturer. Since these have been replaced with another type no further deterioration has been encountered so far.

Adder Converter

An adder, excess-three-converter unit for the test computer was constructed as the second test component. Figure 8 is a block diagram of the adder converter. This equipment was paralleled with the existing vacuum tube arithmetic unit. Results computed by the transistor equipment are substituted for those computed by the vacuum tube adder and a parity check is made between the two results.

The basic circuits for this equipment were laid out on five types of individual plug-in units. A total of 81 such plug-ins are used, containing 110 logical and 20 indicator transistors and 450 diodes.

To date more than 300 hours of operation (39,000 transistor hours) have been logged on this unit since debugging, with no transistor or diode failures.

REFERENCES

- (1) T. P. Bothwell, G. W. Booth and E. P. English, A Junction Transistor Counter with High Speed Carry, "Transistors I", RCA Laboratories, Princeton, N. J. p 646, Mar. 1956.
- (2) D. E. Deutch, A Novel Ring Counter Using Junction Transistors, "Transistors I", RCA Laboratories, Princeton, N. J., p 640, Mar. 1956.
- (3) E. W. Sard, Junction Transistor Multivibrators and Flip-Flops, 1954 IRE Conv Rec, Part II, p 119.
- (4) C. L. Wanless, Transistor Circuitry for Digital Computers, IRE Trans, EC-4, p 11, Mar. 1955.
- (5) T. P. Bothwell, Design of Nonsaturating Junction Transistor Flip-Flop, AIEE Winter General Meeting, Jan. 1955.
- (6) J. Warnock, Junction Transistor Switching Circuits, AIEE-IRE Joint Transistor Conference, Philadelphia, Feb. 1954.

By W. N. COFFEY

General Electric Research Laboratory
General Electric Co.
Schenectady, New York

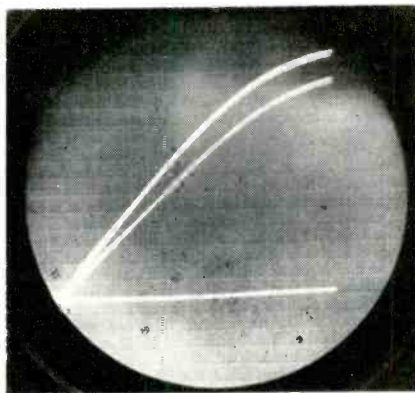

Face of crt shows sweeps just before they are superimposed to indicate correct adjustment of system

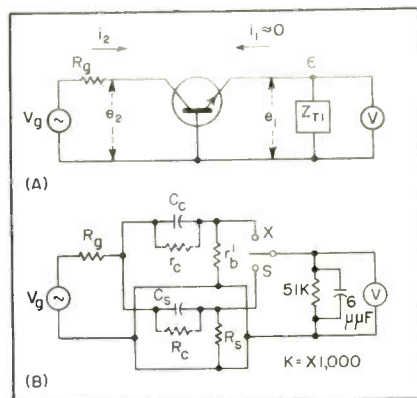

FIG. 1—Basic circuit for measuring h_{12b} (A) and comparison circuit for measuring $r'_b C_c$ product (B)

Sweeper Determines Power-Gain Parameter

SUMMARY — Transistor $r'_b C_c$ product that determines power gain is evaluated by a variable-frequency sweep generator in conjunction with cro and standard network using comparison technique. Two-channel system compares transistor output over range of 2 kc to 2 mc and provides direct dial reading of $r'_b C_c$ product

ONE OF THE MORE useful quantities in evaluating the high-frequency performance of a junction transistor is the available power gain. This gain may be measured directly at frequencies of interest¹ or may be calculated from the measured circuit parameters at those frequencies.^{2, 3, 4, 5}

The h-f power gain may be found from the inherent alpha-cutoff frequency, the ohmic base resistance r'_b and the collector-base junction capacitance C_c , all of which can be measured at low or medium frequencies.

Moreover, the gain is determined from the alpha-cutoff frequency and $r'_b C_c$. This article describes a rapid and accurate means of measuring $r'_b C_c$ product to evaluate quickly the high-frequency capabilities of junction

transistors.

The $r'_b C_c$ product is related to the common-base h_{12} parameter by⁶ $h_{12b} = h_{120} + j\omega r'_b C_c$, where h_{12b} is the common base voltage feedback parameter, h_{120} is the low frequency value of h_{12b} , ω is the frequency in radians per sec, r'_b is the ohmic base resistance and C_c is the inherent collector-base capacitance.

The quantity h_{120} is the sum of the Early feedback voltage μ_{ec} and the product of r'_b and the collector-base conductance.⁷

The parameter h_{12} can be measured in a circuit as shown in Fig. 1A. The impedance Z_{11} consists of the impedance of the voltmeter and the impedance of the circuit used to supply d-c emitter current to the transistor.

Since the emitter-base terminat-

ing impedance Z_{11} is many times the short-circuit input impedance h_{10b} , then $h_{12b} \cong e_1/e_2$.

The first and second equations result in $e_1/e_2 = h_{120} + j\omega r'_b C_c$. At the higher frequencies where $\omega r'_b C_c \gg h_{120}$, $e_1/e_2 = \omega r'_b C_c$, so that if e_2 is constant with frequency the measured voltage e_1 will be proportional to frequency.

In the sweeper, the output voltage of the transistor e_1 is compared with the output voltage of a simple R-C high-pass network as shown in Fig. 1B.

An exact equivalent circuit for the transistor is not shown here but rather an exact circuit to represent the measurement of h_{12b} . If the transistor and the comparison network R,C, are driven from a common a-c voltage generator, then a

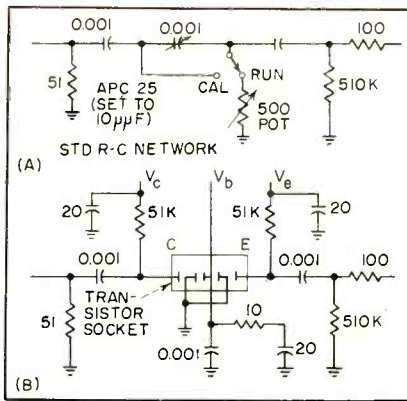
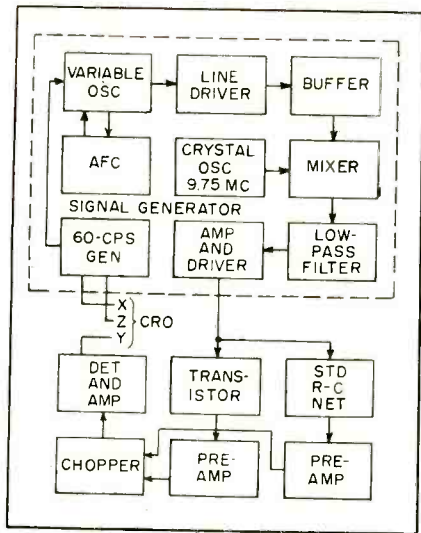

FIG. 3—Input circuit to standard preamplifier (A) and transistor preamplifier (B) used in sweeper system
 FIG. 2—Complete system required to measure power gain parameter

vides a control current for the sweep oscillator that will give a linear rate of change of frequency versus time. A linear sawtooth is generated for X-axis deflection. The 60-cps multivibrator in this circuit is synchronized by 6.3 v a-c heater voltage. The output voltage of the sweep oscillator is maintained flat over the frequency range by an avc circuit.

To heterodyne the 9.752-mc to 11.75-mc interval down to 2 kc to 2 mc the variable-oscillator signal mixes with a 9.75-mc signal from a third-overtone crystal oscillator. The lower side band is selected from the plate circuit of a pentagrid-mixer stage by a low-pass filter consisting of two constant- k pi sections with a cutoff frequency of 7.8 mc and terminating half sections of the m -derived type that provide nearly infinite attenuation at 9.75 mc.

The filter is followed by a gain-controlled video-amplifier stage and a line driver working into an a-c load of 25 ohms. This stage supplies the nominal 0.2-volt peak-to-peak signal, impressed across the collector-base terminals and input to the R,C network. The signal generator portion of the circuit is now a packaged unit.

Direct current bias is delivered to the transistor in the shunt-feed arrangement of Fig. 3. The comparison network consists of an APC-25 variable capacitor set to 10 μ f and a 500-ohm carbon po-

voltmeter connected at the output terminals of either the transistor channel or the comparison channel will indicate the same voltage if $R,C = r',C_c$.

If these two voltages remain equal as the frequency of V_p is changed over an interval Δf , and if R , and C , are independent of frequency over this interval, then r',C_c must be independent of frequency over the interval.

Resistor R , is a 500-ohm variable resistance and C , is a fixed element of 10 μ f. The maximum value of the r',C_c product, which can be measured is thus 5,000 ohm- μ f. Accuracy of the measurement decreases as the frequency increases. This occurs when the reactance of the parasitic capacitance shunting R , is no longer negligible compared

with R , and when the reactance of the parasitic inductance in series with R , is no longer small when compared with R .. The first condition occurs at high values of R ., the second at low values. Using R-C high-pass networks with parameters known to 1 percent as sample transistors the sweeper determined the R-C products within 5 percent of the calculated value.

Circuit Description

A block diagram of the sweeper is shown in Fig. 2. The variable oscillator is swept from 9.752 mc to 11.75 mc at a 60-cps rate by applying a quasisawtooth current to the control winding of the oscillator tank coil. An integrating network in the sweep circuit portion of the 60-cps timing generator pro-

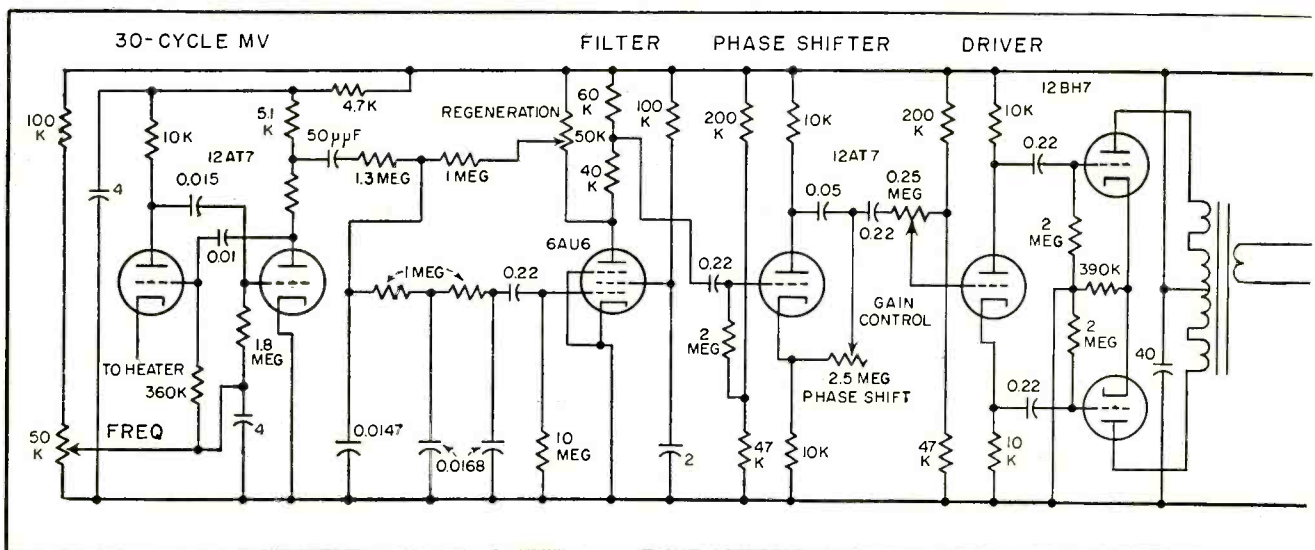

FIG. 4—Chopper driver uses filament as source of 30-cycle synchronization. Filter removes high-frequency components from multi

tentiometer with a dial calibrated in ohms. The R-C product is thus ten times the dial reading.

The comparison network and the transistor are followed by video preamplifiers with voltage gains of about 100 and bandwidth from about 1 kc to 4 mc. In addition, the comparison channel provides a gain control to allow the amplification of the two channels to be equalized.

The output from the two channels is coupled to a chopper. Each channel is alternately connected to the main video amplifier shown in Fig. 4 for 1/60 second. This amplifier has a voltage gain of about 100, bandwidth of approximately 1 kc to 3 mc and is equipped with the master gain control. The amplifier is followed by a diode envelope detector with a load impedance time constant of about 330 μ sec, which is a compromise between adequate filtering for the carrier signal and fast response to the 60-cps fundamental modulation frequency and its harmonics.

The chopper is driven by a 26 volt, 30 cps sine wave obtained from a 30-cps multivibrator also shown in Fig. 4. It is synchronized from the 6.3 v a-c heater voltage.

The following stage is an electronic filter that transmits only the fundamental sinusoidal component of the rectangular wave. A phase shift network allows the chopper to commutate at the proper time with respect to the sweep period.

The envelope-detector output is applied to the vertical axis input terminals of an oscilloscope with a response down to d-c and equipped with a long-persistence phosphor screen to eliminate 30-cps flicker. The complete sweeper requires 300 v d-c at 390 ma for the plate power.

Calibration

Initial calibration of the sweeper requires strapping through both the comparison channel (set switch to calibrate) and the transistor channel (place jumper wire between *e* and *c*). The gain in both channels is equalized over the entire swept spectrum. If it is impossible at first to make the two traces coincide perfectly, small 0.5 to 5.0 μ mf trimmer capacitors can be added between plate and ground of one of the preamplifier stages to compensate for small variations in tube and wiring capacities.

To measure an unknown R-C product, adjust the calibrated potentiometer until the two traces on the display tube coincide. The value of the product can then be found from the reading on the dial.

Compensation

It may be difficult to match the trace generated by a transistor of moderate h_{120} with the trace from the comparison network. For precision the two traces should coincide and to accomplish this it is necessary to add the proper value

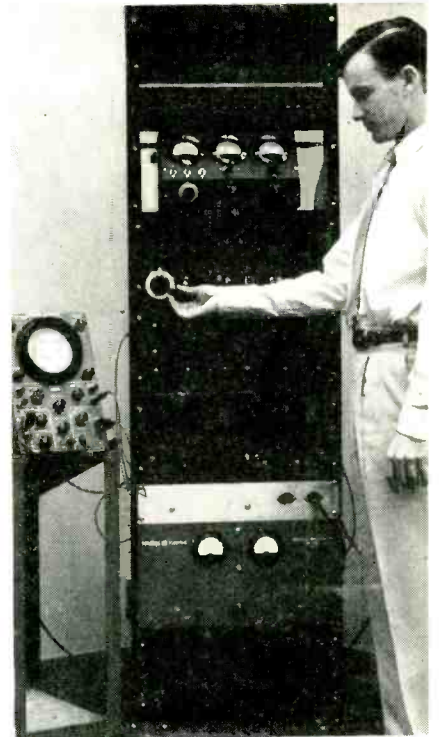

Potentiometer in standard network is adjusted to produce sweeps that are superimposed on face of cro.

of resistance R_c across the capacitance C_c . Small $\frac{1}{2}$ -watt composition resistors that can be plugged into the circuit will be satisfactory if it is remembered that their shunt capacitance of about 0.8 μ mf must be added to the value of C_c . The value of h_{120} can be determined approximately by $h_{120} \cong R_s/R_c$ since in most cases $R_c \gg R_s$.

The value of R_s is available on the calibrated potentiometer dial.

The author thanks R. L. Pritchard for many helpful discussions and H. W. Griffin, Jr. for his assistance in the design and testing of the sweeper.

REFERENCES

- (1) W. F. Chow, Transistor Power Gain Meter, *Tele-Tech and Electronic Industries*, 15, p 104, June 1956.
- (2) R. L. Pritchard, Small Signal Parameters for Transistors, *Electrical Engineering*, 73, p 903, Oct. 1954.
- (3) R. L. Pritchard, High-Frequency Power Gain of Junction Transistors, *Proc IRE*, 43, p 1078, Sept. 1955.
- (4) L. J. Giacoletto, Study of p-n-p Alloy Junction Transistors from D-C Through Medium Frequencies, *RCA Rev*, 15, p 555, Dec. 1954.
- (5) J. M. Early, PNIP and NPIN Junction Transistor Triodes, *BSTJ*, 33, p 519, May 1954.
- (6) R. L. Pritchard, Frequency Variations of Junction Transistor Parameters, *Proc IRE*, 42, p 792, May 1954.
- (7) J. M. Early, Effects of Space-Charge Layer Widening in Junction Transistors, *Proc IRE*, 40, Nov. 1952.
- (8) R. L. Pritchard and W. N. Coffey, Small Signal Parameters of Grown Junction Transistors at High Frequencies, *IRE, Conv Rec*, 2, Part 3, p 90, 1954.

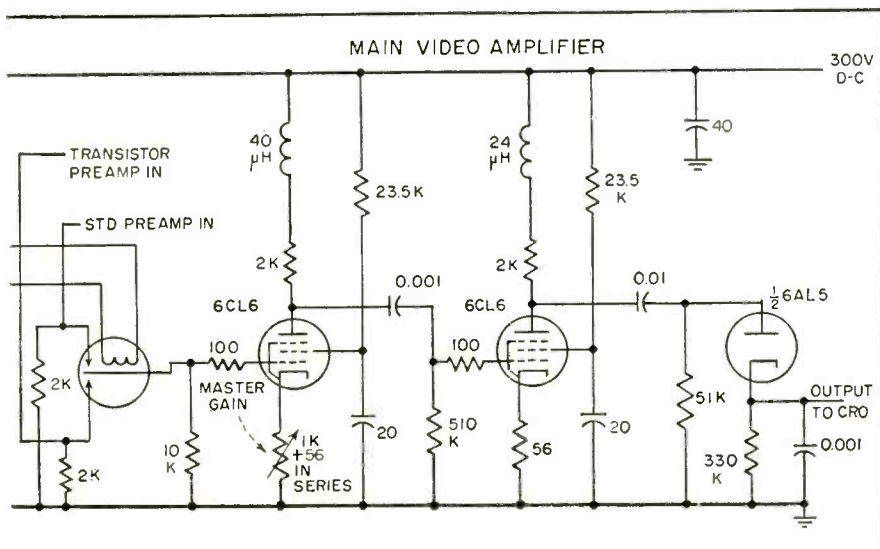

vibrator output to provide sinusoidal drive to chopper in main video amplifier

Transistor Transformer Design Nomographs

SUMMARY — Critical parameters of volts per turn and magnetizing inductance for transistor-driven audio coupling transformers are conveniently given by individual nomographs. Final chart gives wire size

TRANSISTORS operate with lower input impedance and higher output impedance than tubes, hence transformer coupling often becomes more expedient than R-C coupling for audio circuits.

The transformers required are only a fraction of a cubic inch in volume and weigh only a fraction of an ounce. The accompanying nomographs simplify the design of these subminiature a-f transformers for use in transistor circuits.

Turns and Core Area

For sinusoidal flux changes the basic transformer equation is

$$e = N K A B f / 3,490 \quad (1)$$

where e is rms primary volts, N is number of primary turns, K is stacking factor, A is core cross-sectional area in sq in., B is peak flux density in kilogauss and f is frequency in cps.

Having selected the core material and the maximum value of flux density allowable from physical considerations, the designer must determine the number of turns and the core area from the operating voltage and frequency. The stacking factor is usually specified by the core lamination manufacturer and is essentially constant.

The volts-per-turn design nomograph in Fig. 1 is readily constructed by rearranging Eq. 1 in the form

$$(e/N) (3,490) = (KAB) (f) \quad (2)$$

The operating frequency is known from the circuit applica-

By **C. J. SAVANT**
and
C. A. SAVANT

*Servomechanisms, Inc.
Western Division
Hawthorne, California*

volts per turn can be read directly on the nomograph. Division of primary volts by the value of e/N gives the number of primary turns.

Magnetizing Inductance

In a transformer-coupled amplifier, the loading effect of the transformer working through the high output impedance of a grounded-emitter transistor may be serious. For low-power transformers at audio frequencies the most significant parameter in the determination of this load-

(Continued on p 206)

tion of the transformer. To get KAB , the maximum flux density is taken from the B-H characteristics for the particular iron, K is obtained from the iron specifications and the approximate area is taken from the known size requirement. From these values of f and KAB , the

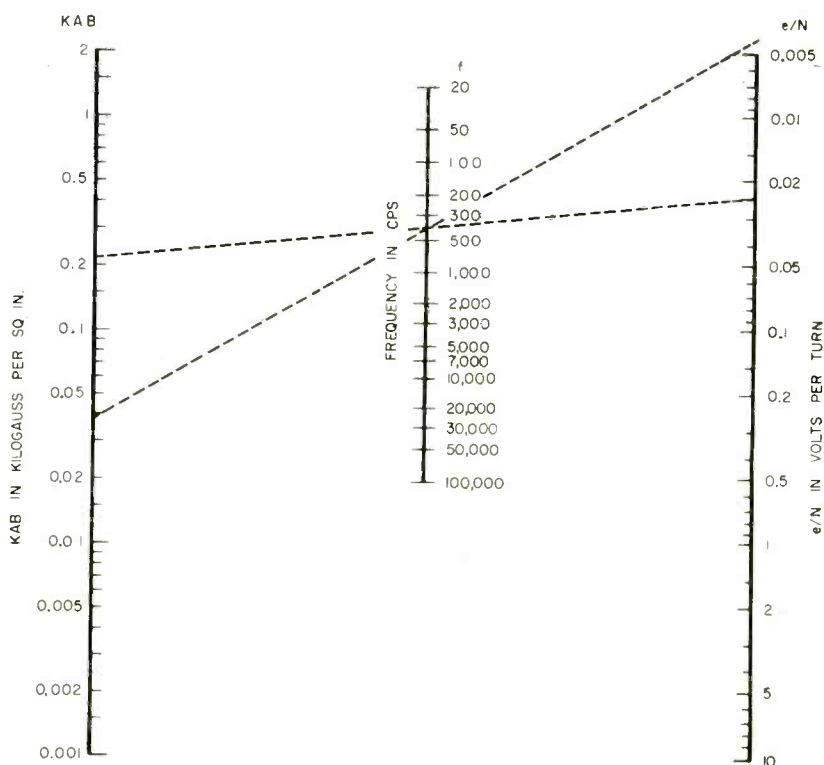

FIG. 1—Volts-per-turn nomograph for subminiature iron-core coupling transformers used in transistor circuits. Dashed lines correspond to design problem worked out as example

NEW DEVELOPMENTS IN PRINTED CIRCUIT SOCKETS BY CINCH



No. 22920

No. 22920—7 contact miniature molded vertically mounted socket with JAN type shield base. Mica insulation. Silver plated phosphor bronze contacts drop through .062" dia. clearance holes arranged on a .1" X and Y axis.

EXP-9553 — 8 contact button base subminiature molded, vertically mounted socket. Mica insulation. Silver plated beryllium copper contacts drop through .070" dia. clearance holes arranged on a .1" X and Y axis.

EXP-9553A—Same as above except insulation to withstand temperatures above 200° Centigrade.

No. 22024—7 contact flat press subminiature molded, vertically mounted socket for conventional wiring. Assembled with a special shield base to accept a subminiature shield with the "J" lock. Flat sided retaining nuts and screws are provided for mounting. Mica insulation. Silver plated beryllium copper contacts.

No. 22023—Same as above except insulation to withstand temperatures above 200° Centigrade.

No. 22022 — 8 contact button base subminiature molded vertically mounted socket for conventional wiring. Assembled with special shield base to accept a subminiature shield with the "J" lock. Mica insulation. Silver plated beryllium copper contacts.

No. 22021—Same as above except insulation to withstand temperatures above 200° Centigrade.

EXP-9542—7 contact miniature molded right angle mounted socket with JAN shield base. Mica insulation. Silver plated beryllium copper contacts drop through .062" dia. clearance holes arranged on a .1" X and Y axis.



EXP-9553



No. 22024



No. 22022

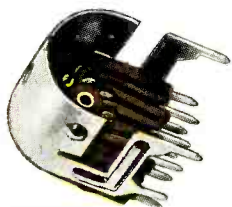

EXP-9542



EXP-9561



EXP-9562

EXP-9561 — 7 contact flat press subminiature molded right angle socket. Mica insulation. Silver plated beryllium copper contacts drop through .046" dia. clearance holes arranged on a .1" X and Y axis.

EXP-9561A—Same as above except insulation to withstand temperatures above 200° Centigrade.

EXP-9562—8 contact button base subminiature molded, right angle mounted socket. Mica insulation. Silver plated beryllium copper contacts drop through .046" dia. clearance holes arranged on .1" X and Y axis.

EXP-9562A — Same as above except insulation to withstand temperatures above 200° Centigrade.



These sockets will take care of the three types of receiving tubes in use today: Miniature, Flat Press and Button.

The contacts are so spaced that they can be mounted in an incremental drill pattern as stated. This fact together with the exact precision and uniformity of Cinch sockets make them ideal for automatic assembly.



Cinch
ELECTRONIC
COMPONENTS

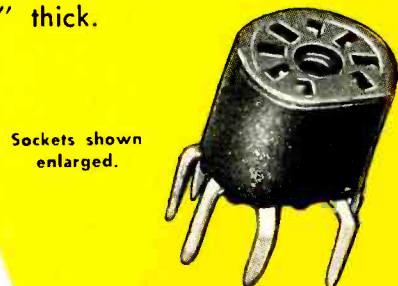

Sockets shown enlarged.

EXP-9553

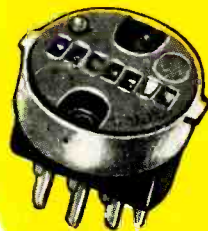

No. 22024

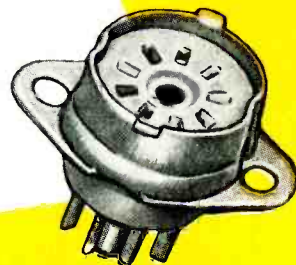

No. 22022

Centrally located plants at Chicago, Illinois; Shelbyville, Indiana; LaPuente, California; St. Louis, Missouri.

VISIT CINCH
BOOTH No. 2535,
AT THE IRE SHOW

For Your Connector Requirements —
You Can Depend On Cinch

CINCH MANUFACTURING CORPORATION

1026 South Homan Ave., Chicago 24, Illinois

Subsidiary of United-Carr Fastener Corporation, Cambridge, Mass

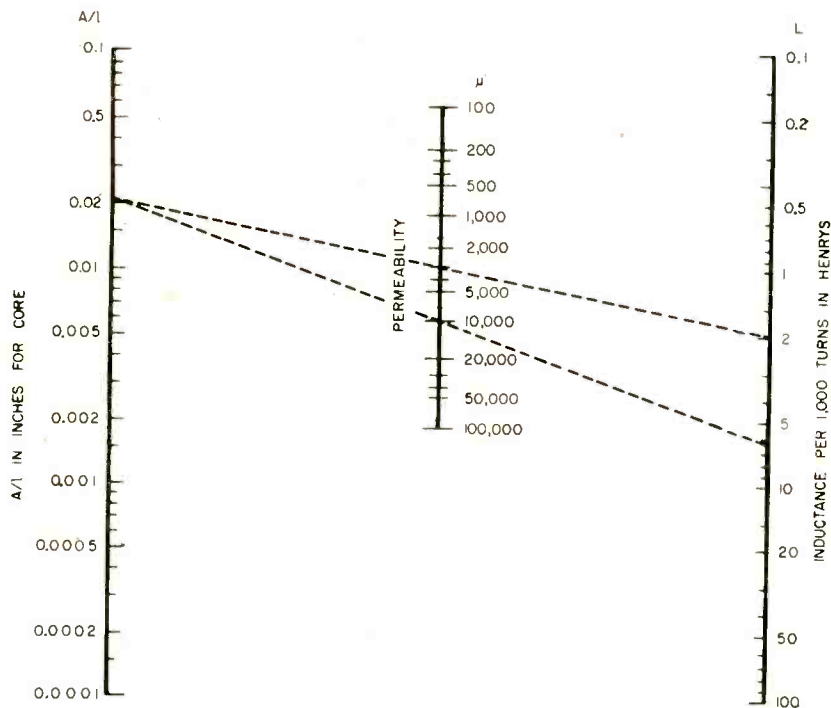

FIG. 2—Magnetizing inductance nomograph for transistor coupling transformers

ing is the shunt magnetizing inductance, L_m , across the primary. A practical equation for this is

$$L_m = K 3.2 N^2 A 10^8 \mu / l \quad (3)$$

where L_m is magnetizing inductance in henrys, μ is incremental permeability for the core material and l is magnetic path length.

It is again possible to construct a nomograph to facilitate design calculation, if Eq. 3 is rewritten as

$$L_m' = (A/l) (\mu) (K \times 320) \quad (4)$$

where L_m' is inductance per thousand turns. The nomograph is given in Fig. 2. The minimum

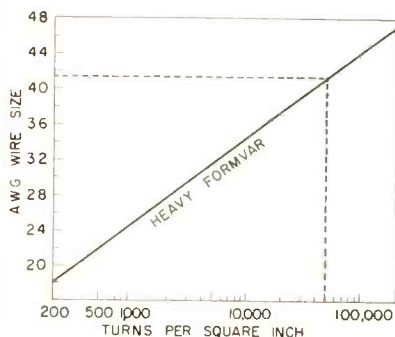

FIG. 3—Wire size chart for transformers using heavy Formvar insulation on windings. For single Formvar or plain enamel, increase turns per sq in. by six percent

allowable inductance per thousand turns is determined from the circuit application of the transformer. Transformer dimensions, the turns ratio and the initial permeability are then chosen to satisfy the nomograph, and wire size to fit the available window area is found from Fig. 3.

Example of Use

A transistor transformer is to be designed for matching a 5,000-ohm source to a 500,000-ohm load, using a 10-v, 400-cps primary and a 6.6-v secondary. Maximum phase shift is 10 deg.

When the transformer is operated from the specified source impedance, neglecting transformer losses, the magnetizing inductance required for 10-deg phase shift at 400 cps is

$$L = \frac{5,000}{(2\pi) 400 \tan 10^\circ} = 11.3 \text{ h}$$

The core type is selected next, largely from experience, as a laminated core, 187 E-I, in standard 14-mil audio A. For this material, A/l is 0.0216 in., KA is 0.0309 sq in. and permeability is 10,000 at 7 kilogauss. The value of KAB is then

0.0309×7 or 0.216. Using this and a frequency of 400 cps in Fig. 1 gives 0.023 volts per turn for e/N .

With a primary voltage of 10 v, primary turns are 435 and must produce an inductance of 11.3 h. The inductance per 1,000 turns is 11.3 $(1,000/435)^2$ or 59.7 h.

To check the design, use 0.0216 for A/l and 10,000 for permeability in Fig. 2. This gives 6.3 h for inductance per 1,000 turns instead of 59.7 h, hence more turns will be necessary. After one or two trials, 2,400 turns were decided upon for the primary. From Fig. 2, with 11.3 h per 2,400 turns or 1.96 h per 1,000 turns, at A/l of 0.0216 the permeability can be as low as 3,000. From Fig. 1, with e/N at $10/2,400$ or 0.00417 and frequency at 400 cps, KAB is 0.037. Flux density B then is $0.037/0.0309$ or 1.19 kilogauss. At this flux density, the material characteristics indicate that the permeability is actually 4,000, hence the magnetizing inductance of at least 11.3 h can easily be achieved.

The secondary turns will now be $0.66 \times 2,400$ or 1,580. Total turns are then 3,980. The window area for 187 E-I is 0.0822 sq in., hence the turns per square inch are 48,400. From Fig. 3, the allowable wire size is No. 42 heavy Formvar.

Thus, the final design is a primary of 2,400 turns and a secondary of 1,580 turns, both of No. 42 heavy Formvar, with core of 14-mil 187 E-I audio A.

The nomographs in themselves accomplish a simple multiplication. This fact alone would make them of little value. However, the designer of these transformers must manipulate between the circuit requirements, core type and size and wire size until all equations and requirements are satisfied. Actual experience indicates that this trial-and-error process is greatly speeded and simplified by using these nomographs.



When Time is Precious *... Call Your Mallory Distributor*

Your local Mallory distributor is prepared to deliver short orders quickly. He can save you valuable production or research time on repair work, experimental circuits, short production runs, or any of a dozen other applications that call for the *finest* in electronic components . . . and call for them *fast*.

His stocks include the complete range of Mallory capacitors, resistors, controls, rheostats, mercury batteries, vibrators and selenium rectifiers . . . as

well as other related components by well known companies. And you can be assured of quality as well as fast service on your "rush" orders . . . because these are the same superior-performance Mallory products chosen by leading manufacturers for use in original equipment.

For details about this program and the name of your nearest distributor . . . call our local district office, or write to us in Indianapolis.

Depend on MALLORY for Service!

P. R. MALLORY & CO. INC.
Distributor Division, Dept. A
P. O. Box 1558, Indianapolis 6, Indiana



Atmospheric Effects on Propagation

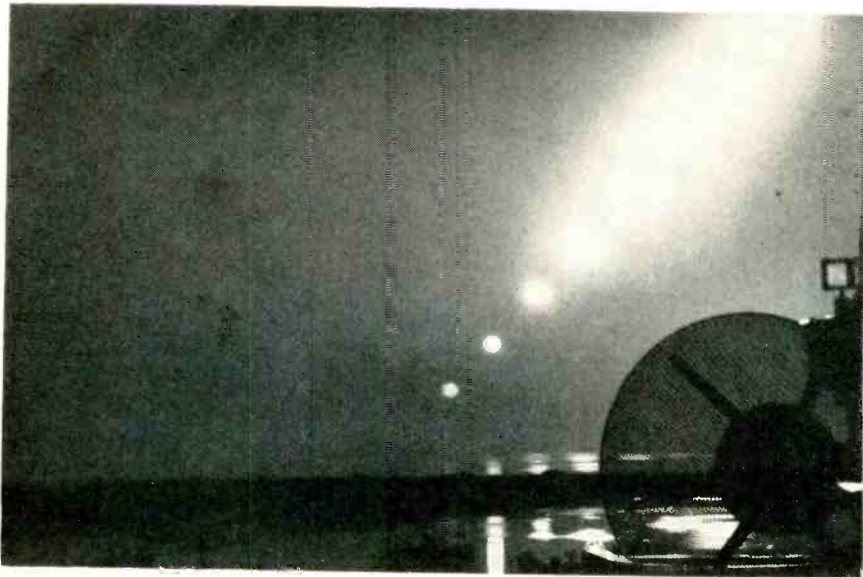

Rising sun photographed at five-minute intervals appears to travel in arc

TRACKING and radio guidance of long-range missiles require precise knowledge of the refractive effects of the atmosphere. Equally important accurate vectoring information for antimissile devices must also take into account these effects. Thus the characteristics of the atmospheric effects are of great importance to the Air Force.

Using the sun as the source of radio-frequency energy, the Electronics Research Directorate of the

Air Force Cambridge Research Center is studying the effect of the atmosphere on microwaves and meter wavelength radiation. Both the ionosphere and the troposphere produce refractive effects and scintillations on solar radio-frequency radiation.

► **Rising Arc**—The accompanying photo, a multiple exposure of the rising sun taken at five-minute intervals, visually demonstrates the

atmospheric effects in that the sun as it rises appears to travel along an arc rather than along a straight line.

The technique used for measuring the atmospheric refraction consists of a single mount for both optical and radio-frequency measurements. A small telescope is used for sighting the position of the sun as it rises through fixed positions of the antenna. Two small parabolic dishes feed stable receivers in the 3-cm and 8-cm region. The sun essentially traces out the antenna pattern. The time difference between the sun's crossing the pattern as recorded on the radio equipment and the time it should cross according to spherical astronomy determines the amount of refraction.

Along with the measurement of the apparent change in position of the sun, the absorption of the atmosphere as a function of angle of elevation and meteorological conditions is determined. Fluctuations in signal are also seen at the lower angles indicating the irregularity in the troposphere. These scintillations are produced by variations in the lower atmosphere and are not apparent at higher angles of elevation.

Sleeve Radiator for TV Reception

By GEORGE P. KEARSE

Senior Engineer
Radiation Laboratory
Temco Aircraft Corp.
Garland, Texas

THIN DIPOLE antennas are not well suited to broadband operation owing to large variations in impedance and radiation patterns. Impedance variations can usually be compensated by well-designed

matching transformers but the radiation patterns are entirely dependent upon the geometry of the dipole and its proximity to ground and other objects.

These pattern changes are not minimized unless its construction is appreciably changed. At higher frequencies increasing the cross-

FIG. 1—Configuration of 54 to 220-mc sleeve dipole

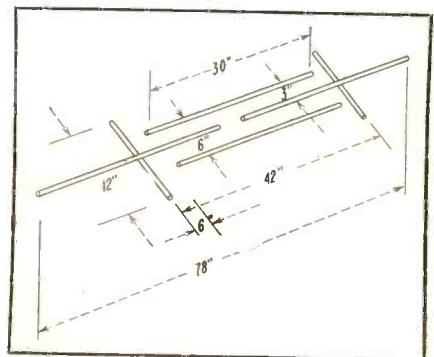



VOLTAGE REGULATED POWER SUPPLIES

*for Transistors • Strain Gages
Relays • Filament Power*

MODEL	Volts	Current	Regulation		Ripple	Recovery Time*	Stability For 8 Hours	Output Impedance		Dimensions			Price
			Line 105-125	Load 0-Max.				DC-20	20 ~ 100 KC	W	H	D	
2600	0-60	0-2 Amp.	5 Mv.	5 Mv.	1 Mv.	50 μ sec.	10 Mv.	0.002 Ω	0.0005 Ω	19"	10 1/2"	17"	\$690
2650	0-60	0-5 Amp.	5 Mv.	5 Mv.	1 Mv.	50 μ sec.	10 Mv.	0.001 Ω	0.0002 Ω	22 1/2"	28"	19"	\$1190

Good stability
Fast recovery time
Low output impedance
Excellent regulation
Low ripple

POWER REQUIREMENTS: 105-125 volts, 60 cycles.
FUSE PROTECTION: Input and output fuses on front panel. Time delay relay is included to prevent unregulated voltage from appearing at the output terminations.

OUTPUT TERMINATIONS: DC terminals are clearly marked on the front panel. Either positive or negative terminal of the supply may be grounded. DC terminals are isolated from the chassis. A binding post is available for connecting to the chassis. All terminals are also brought out at the rear of the unit. Two terminals are mounted at the rear of the chassis to provide for picking up the error signal directly at the load. This connection compensates for the voltage drop in the wires (and ammeter) connecting the power supply to the load.

METERS: Ammeter: 0-2 amperes, 4" rectangular for Model 2600
0-5 amperes, 4" rectangular for Model 2650

Voltmeter: 0-60 volts. 4" rectangular

CONTROLS: Power on-off switch, DC on-off switch, remote error signal on-off switch, coarse and fine voltage controls. The coarse voltage control is a ten turn potentiometer which varies the voltage from 0-60 volts. The fine voltage control is a ten turn potentiometer which varies the voltage 1 volt. The voltage divider network allows a 61 volt variation in output voltage.

*Recovery time is less than 50 microseconds. The excursion in the output voltage during the recovery period is less than 50 millivolts for line fluctuations from 105-125 volts or load variations from 0-to maximum current.



FOR COMPLETE LINE
WRITE FOR CAT. B-568



KEPCO LABORATORIES, INC.

131-38 SANFORD AVENUE • FLUSHING 55, N. Y. • INDEPENDENCE 1-7000

VISIT BOOTHS #2636-2638 • I.R.E. SHOW • N. Y. COLISEUM • MARCH 18-21

section area by means of large conductors, either actual or simulated, reduces pattern and impedance changes with frequency. The conical configuration represents a design widely used to minimize these variations. On the lower frequencies, however, even the conical dipole passes a point of diminishing returns.

The coaxial construction of the sleeve dipole¹ involves mechanical difficulties that also prevent its use in the vhf television channels. However, use of the sleeve principle where overall length of the antenna resonates at one frequency and the length of the sleeve section resonates at a higher frequency results in an excellent dipole element for television applications provided that a different construction be found for the sleeve section.

Since the sleeve section of the dipole is essentially a short length of coaxial transmission line connected in series with short antenna elements, it was believed that another type of transmission line could be used equally well and retain the broadband performance desired.

The three-wire transmission line with the two outer conductors grounded², seemed applicable to the sleeve dipole principle. A sample

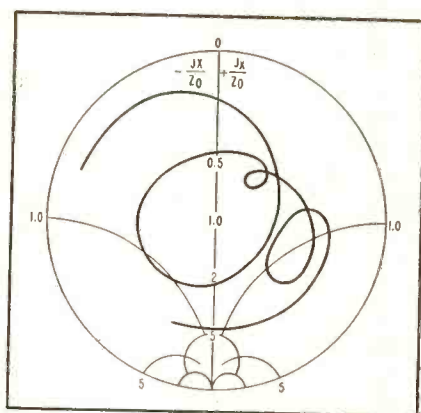

FIG. 2—Impedance plot of sleeve dipole over range from 54 to 220 mc

was constructed and measured. The data indicated that the three-wire transmission line section produced a broadband element that would hold its bi-directional patterns, over a frequency range up to 4 to 1.

Further tests indicated that this range could be increased by changing the current distribution on the end sections of the dipole. This was accomplished by mounting short conductors on the dipole close to each end of the transmission-line section. The upper frequency limit is reached when the length of both the transmission-line section and the short conductors approach one-half wavelength. Above this frequency, the pattern changes to one

that is normal for a harmonically operated antenna.

Since this dipole is the outgrowth of a television antenna investigation the dimensions and data are shown for the vhf television bands. It is believed, however, that essentially the same performance could be duplicated on much lower frequencies. Figure 1 shows a sketch of this dipole designed to operate in the frequency range of 54 to 216 mc. Figure 2 shows impedance variations from 50 to 220 mc that appear normal for a dipole operating over such a wide frequency range. Figure 3 shows the measured radiation patterns. The bidirectional patterns remain essentially constant.

The first application of this dipole was to an antenna for vhf television reception. In this application, it was necessary to substitute a folded dipole for the driven element to raise impedance. The short conductors were also found to be unnecessary. The folded dipole was cut to a half wavelength at the low-frequency end of the lower tv channels, while the transmission line section was cut to a half wavelength in the low-frequency end of the upper tv channels. Separate reflectors, spaced approximately a quarter wave-

Canada Gains Computing Center

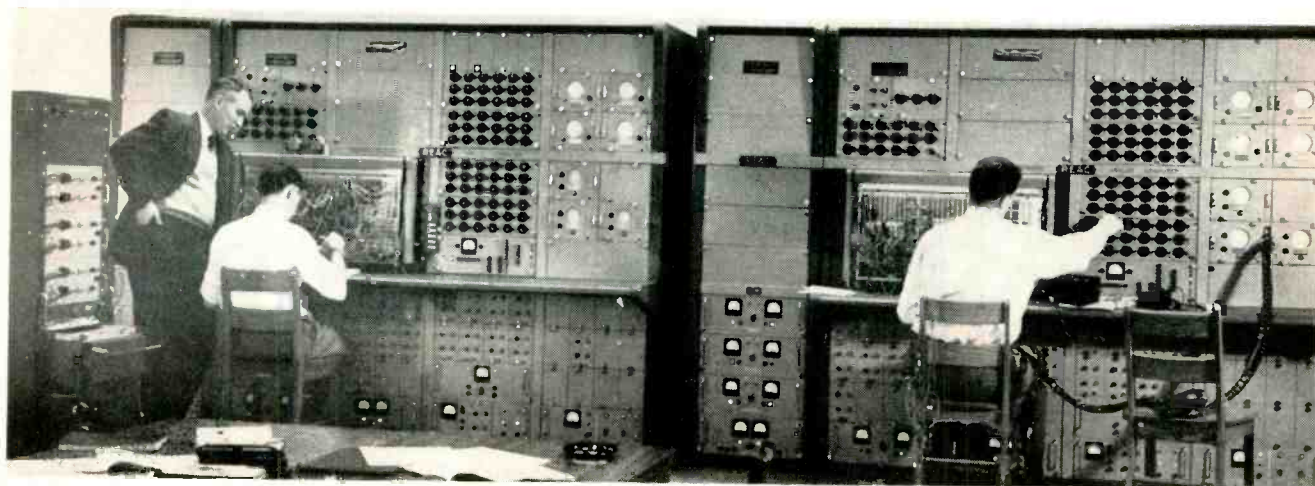

Two identical analog computers that can be used independently or connected together have been installed in the new computing center of Computing Devices of Canada, Ltd. The machines are

Reeves Reacs built to CDC specifications and are for use by engineering organizations on a rental basis. The instrument on the left is a recording voltmeter used to make permanent records

Another
product
surprise
from
Helipot!

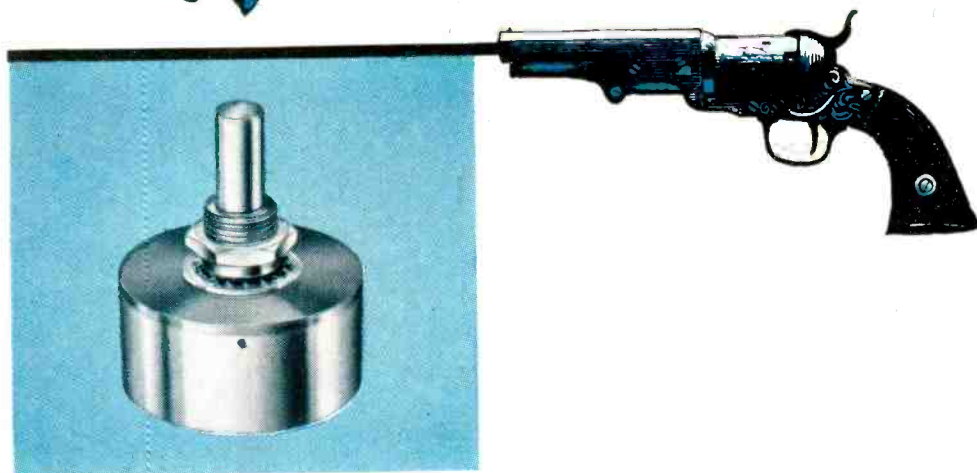
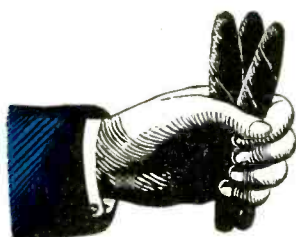

Fanfare & Cigars

Tooting a symbolic clarion and passing out imaginary cigars, Helipot introduces one of its new-born offspring . . . the series 5300 precision potentiometer.

A single-turn unit, it's 1-1/4 inches in diameter . . . designed for bushing mounting. With its innards comfortably ensconced in an accurately drawn one-piece aluminum cup, the 5300 gives you ruggedness, compactness and long life. We proud papas direct your attention to such salient features as the range of total resistance . . . from 25 to 49,000 ohms . . . linearity as close as $\pm 0.25\%$. . . and considerable improvement in torque, noise and mechanical runout.

For vital statistics on this prodigy of a progeny, write for data file 321.

Helipot makes precision potentiometers . . . linear and non-linear . . . in the widest choice of sizes, mounting styles and resistances. Many models are stocked for immediate shipment. Our engineers will gladly adapt standard models to your requirements or design entirely new HELIPOT® precision potentiometers for you.

Beckman®

Helipot Corporation: Newport Beach, California
a division of Beckman Instruments, Inc.
Engineering representatives in principal cities

955® REG. U. S. PAT. OFF.

length at their respective frequencies, were first tried. It was found that side lobes were produced by radiation from the ex-

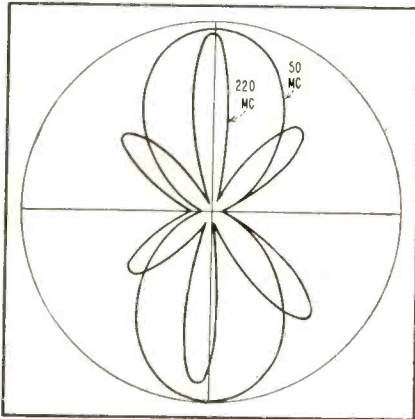

FIG. 3—Radiation pattern of sleeve radiator at extremes of frequency range

tremities of the long folded dipole when the antenna was operated on the upper frequencies. A three-section reflector was found necessary to produce the desired patterns.

The author wishes to thank Norbert Sladek and Allan Crites who built the samples, took the data and otherwise assisted in the development of this dipole and R. M. Soria for his guidance and constructive criticism. The work was done while the author was with Amphenol Electronic Corp.

REFERENCES

- (1) "Very High Frequency Techniques," Vol. I, Radio Research Laboratory, Harvard University, McGraw-Hill Book Co., Inc., New York.
- (2) E. A. Laport, "Radio Antenna Engineering," McGraw-Hill Book Co., Inc., New York.

Light Actuated Transistorized Counter

By JOHN GRANT
*Applications Department
 Electronics Division
 Sylvania Electric Products
 Woburn, Mass.*

Many circuits and devices have been used for controlling a relay or other actuating mechanism by the light falling on a photocell. This article will describe a simple circuit using semiconductor devices. It incorporates a 1N77A photodiode and two 2N35 germanium junction transistors.

The light-actuated section of the circuit is a bridge in which the 1N77A photodiode is one leg. The diode's reverse resistance is approximately balanced by the 100,000-ohm resistor. The opposite side of the bridge is a 50,000-ohm potentiometer. The potentiometer is used to vary the no-signal cur-

rent through the relay and to set the overall circuit gain by biasing the transistors into a higher gain region.

The two-stage transistor amplifier is connected in the common-collector configuration to take advantage of the maximum available current gain. The 10,000-ohm resistor increases somewhat the second stage transistor stability and keeps the amplifier input impedance at approximately 100,000 ohms for maximum power gain.

When a light beam strikes the light-sensitive junction of the photodiode, the reverse resistance of the diode decreases, thereby increasing the voltage at the base of the first transistor. The increased voltage allows emitter current to flow from the first transistor into the base of the second transistor. The increased base current of the second transistor increases the emitter current through the relay coil and actuates the relay armature.

If the 50,000-ohm potentiometer is not adjusted correctly, the voltage at the base of the first transistor will be too negative with respect to its emitter for the change in bridge voltage to turn the transistor on. On the other hand, if the potentiometer is set too far in the opposite direction both transistors will stay on. A small amount of experimentation will give the potentiometer setting for the best operation of the amplifier.

The relay used in this setup was

Boiler Analysis By Remote Control

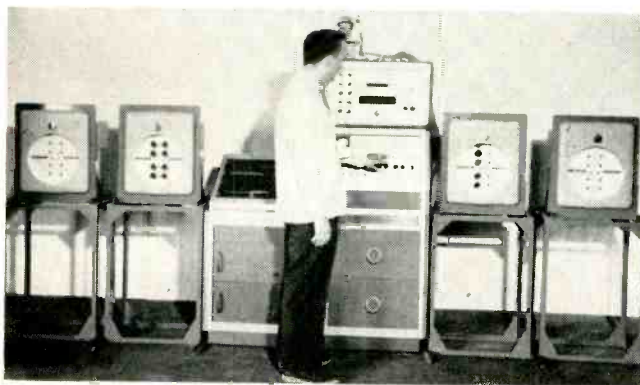

Designed to analyze operation of a giant steam generating unit in a few hours, a system developed jointly by Babcock & Wilcox and Bailey Meter can make use of a central computer in New York City over teleprinter circuits. After the information has been

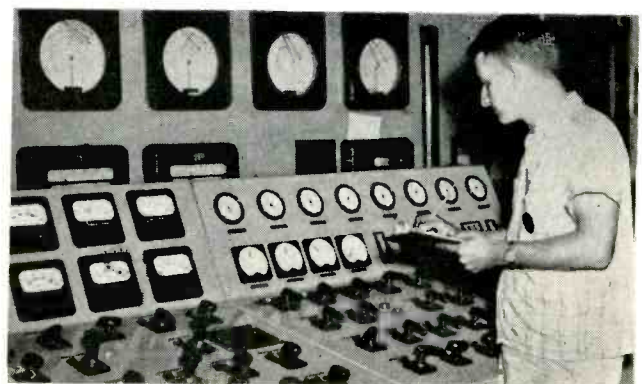

evaluated, the resulting figures are returned to the boiler site for application by technicians. Data indicated at the boiler room control point (right) is likewise picked up by equipment (left) that transforms signals to digits and punches out tape on a perforator

*If forward voltage drop is a problem
in your diode circuitry...see the*



**GOLD
BONDED**

RADIO RECEPTOR

Germanium Diode DR 385

*Available now in
production quantities
for immediate delivery*

with controlled forward voltage drop
between 0.34 and 0.37V at the
10MA level

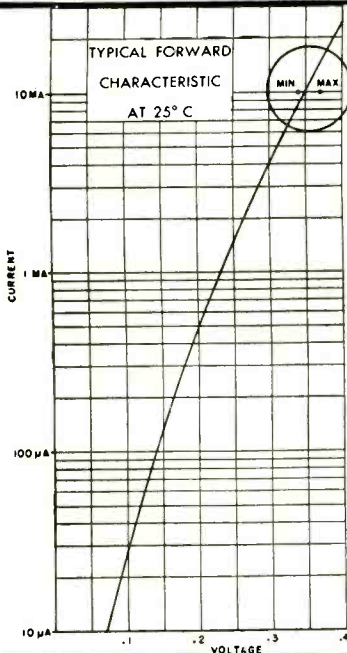

Design engineers working with transistorized circuits, computers and other applications will find that RRco. Type DR 385 has extremely low forward voltage drop as well as other desirable features... The specifications speak for themselves!

Characteristics at 25° C

Forward voltage drop @ 10MA	
Minimum	0.34V
Maximum	0.37V
Maximum reverse current at -10V	10UA
Peak inverse voltage	60V

Maximum Ratings at 25° C

Maximum inverse operating voltage	50V
Continuous DC forward current	100MA
Surge current for 1 second	500MA
Average power dissipation	80MW
Derating above 25° C	10MW/10° C

*DR 385 exhibits fast transient response and similar diodes
can be offered fully tested to your recovery conditions.*

Further information on DR 385, or any other RRco. diode type will be sent you at once upon request to section E-3.



*In Radio and
Electronics Since 1922*

Semiconductor Division
RADIO RECEPTOR COMPANY, INC.

240 Wythe Avenue, Brooklyn 11, N. Y. • EVERgreen 8-6000

Radio Receptor Products for Industry and Government: Selenium Rectifiers • Germanium Diodes
Thermatron Dielectric Heating Generators & Presses • Communications, Radar & Navigation Equipment

See us at the IRE Show, Booths 1307 & 1309



need sub-miniature relays?

AEMCO'S Type 95 Sub-miniature Relay is "first choice" for design engineers working toward miniaturization and modification of existing equipment. Sealed in a tiny crystal case, AEMCO'S 95 relay weighs less than 1/2 ounce . . . measures only .78" in length! Now available with a wide variety of terminals and mountings, this relay is adaptable to a number of applications previously limited.

TWO BASIC UNITS AVAILABLE: 95-2029 with DPDT contacts rated at one amp. @ 28 VDC. 95-2267 with either one of two combinations, (SPDT and SPST-N.O. or, SPDT and SPST-N.C.) rated at 0.25 amps @ 28 VDC, permitting design variation to fit most applications.

OTHER RELAY TYPES AVAILABLE

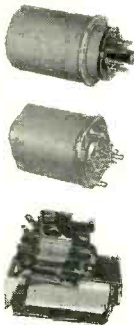

Typical of AEMCO ingenuity, type 95 Sub-miniature Relay is just one unit from AEMCO'S complete relay line. Others are available in a wide choice of spring and coil combinations, operating potentials and contact ratings. If one of the hundreds of AEMCO relay types does not exactly meet your specifications, we will be happy to design and manufacture a unit to meet or exceed your requirements.

AEMCO also manufactures a complete line of SEQUENCE and AUTOMATIC RE-SET TIMERS, TIME SWITCHES, and SIGN FLASHERS.

WRITE TODAY—Your inquiries are invited. Ask for Bulletin "H" which describes the 95 as well as other relays in the complete AEMCO line.



AEMCO INCORPORATED
13 State Street • Mankato, Minn.

Want more information? Use post card on last page.
214

a Sigma 5F-1000-G. It was set to close at 4 ma and open at 2 ma. Approximately 5 to 6 ma can be drawn through the relay for positive switching action.

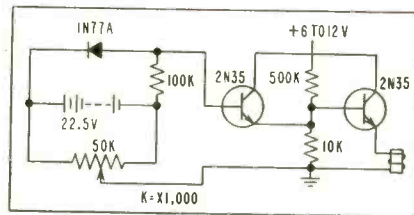

Light operated relay will trigger counter tube at rates better than 60 counts per sec

With a miniature 22.5-v battery and a 6-v battery, the entire device can be built in a box smaller than 6 in. x 2 in. x 2 in. The output of the relay has been used to control a mechanical counter up to 200 counts per minute. If used in conjunction with a glow transfer counter tube, rates better than 60 counts per second could be easily handled. The photodiode frequency response is about 15 kc and the transistors can handle 600 kc.

Applications are as a headlight controlled garage door opener and a production-line controller for counting and material detection. Clear glass rod of 1/4 in. diameter has enough diffusion effect on a small light beam to actuate the counter. An automobile headlight

will trigger the amplifier at distances of the order of 10 feet or more depending on whether an optical system is used to concentrate the light beam.

The battery drains are small with no-signal drains of the order of 0.5 ma. Either delayed relay pull-in or drop-out may be obtained by placing a 10 μ f capacitor either from the first transistor base to ground or across the 10,000-ohm resistor. Varying the capacitor will allow delays of 10 seconds or less.

Grid-Operated Thyatron

By L. L. BOYARSKY
*Dept. of Anatomy and Physiology
University of Kentucky
Lexington, Kentucky*

BIOLOGICAL INVESTIGATIONS require the use of a relay activated when contact is made through an animal. In measuring the drinking rate, for example, the animal's tongue touches a drinking tube and contact is established. The current through the tongue is of the order of microamperes, so that a current amplifying device is needed.

The circuit shown here is designed on the basis of a rarely used property of gas-discharge tubes. Usually, the plate voltage must be

British Atomic Research Uses TV

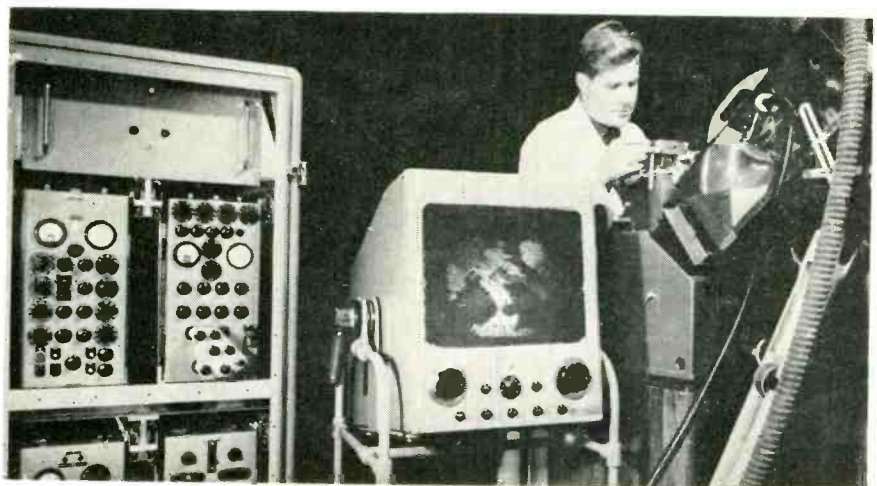

Experimental television microscope used at Britain's Atomic Energy Research Establishment, Harwell. A demonstration image is shown on the 15-inch screen. Purpose of the equipment is to enlarge highly radioactive metal specimens without damage to the eye of the researcher

FIRST silicon transistors meeting NAVY SPECS

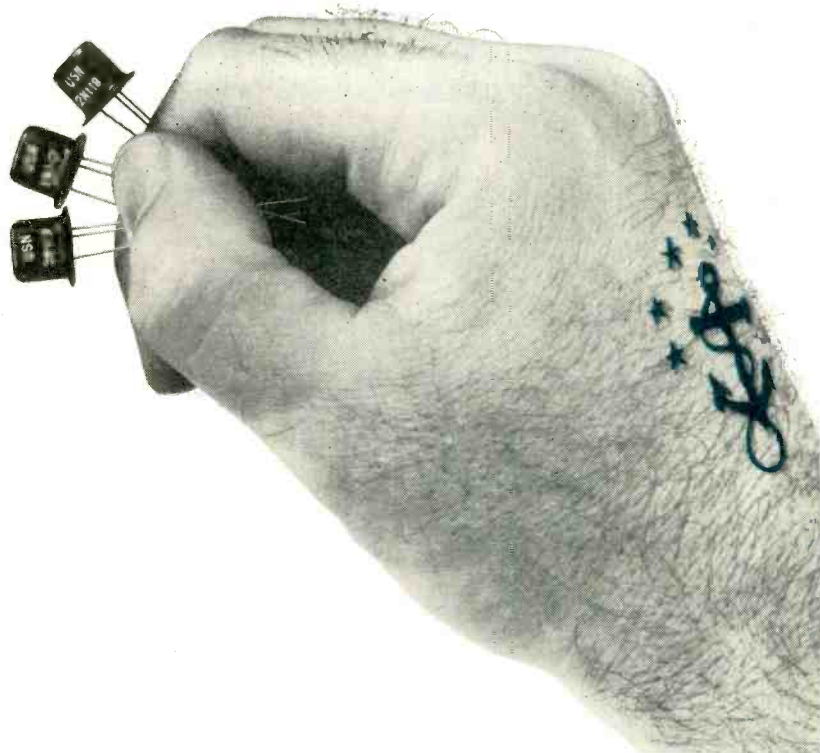

For *reliability* under *extreme* conditions... design with TI's military silicon transistors... built to give you high gain in small signal applications at temperatures up to 150°C. Made to the stringent requirements of MIL-T-19112A (SHIPS), MIL-T-19502 (SHIPS), and MIL-T-19504 (SHIPS) — these welded case, grown junction devices furnish the tremendous savings in weight, space, and power you expect from tran-

sistorization... *plus* close parameter control that permits you to design your circuits with confidence.

All 20 Texas Instruments silicon transistor types have proved themselves in military use. First and largest producer of silicon transistors, TI is the country's major supplier of high temperature transistors to industry for use in military and commercial equipment.

degradation rate tests for TI's USN-2N117, USN-2N118, and USN-2N119

test	condition	duration	end point at 25°C
lead fatigue	three 90-degree arcs	—	no broken leads
vibration	100 to 1000 cps at 10 G	3 cycles, each x, y, and z plane	$I_{CO} = 2\mu A$ maximum at 5V $h_{ob} = 2\mu mhos$ maximum $h_{fb} = -0.88$ minimum (USN-2N117) $h_{fb} = -0.94$ minimum (USN-2N118) $h_{fb} = -0.97$ minimum (USN-2N119)
vibration fatigue	60 cps at 10 G	32 hours, each x, y, and z plane	
shock	40 G, 11 milliseconds	3 shocks, each x, y, and z plane	
temperature cycle	-55°C to +150°C	10 cycles	
moisture resistance	MIL-STD-202	240 hours	
life, intermittent operation	$P_c = 150 mW, V_c = 30V$	1000 hours, accumulated operating time	
life, storage	150° C, ambient	1000 hours	
salt spray	MIL-STD-202	50 hours	no mechanical defects interfering with operation

**LOOK TO TI FOR: SILICON HF, MEDIUM POWER, POWER, AND SMALL SIGNAL TRANSISTORS
SILICON DIODES AND RECTIFIERS • GERMANIUM VHF, POWER, RADIO, AND GENERAL PURPOSE TRANSISTORS**

**pioneer producer of
silicon transistors**



**TEXAS INSTRUMENTS
INCORPORATED
6000 LEMMON AVENUE DALLAS 9, TEXAS**

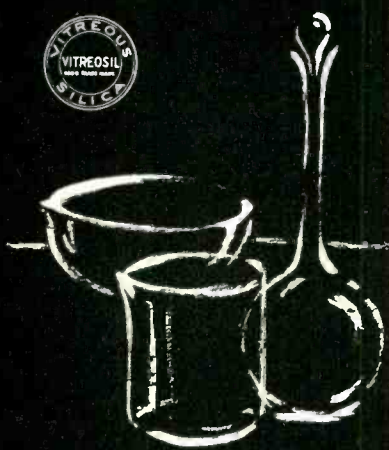

Look no further—
If you're looking for
"HIGH PURITY"
fused quartz
LABORATORY WARE

The world's largest producer of fused quartz products can help you with your most critical and exacting needs for your laboratory ware.

Vitreosil® products can be supplied in an unusually large variety of types and sizes. Also fabricated to specification to meet semiconductor requirements for the production of silicon metal.

TRANSPARENT VITREOSIL

For ultra-violet applications, metallurgical investigations, chemical research and analysis, photochemistry, spectroscopy and physical, optical and electrical research.

Send specifications for your requirements. Please use coupon below.

**THERMAL AMERICAN
 FUSED QUARTZ CO., INC.**
 18-20 Salem Street, Dover, New Jersey

Please send technical data on _____

 Company _____
 Name & Title _____
 Street _____
 City _____ Zone _____ State _____

Want more information? Use post card on last page.

lowered if the grid of a thyratron is to regain control of the tube. If, however, the plate supply voltage is maintained at a lower level so that the plate current is low, a high negative grid voltage will turn off the tube.¹

Using this principle, the plate

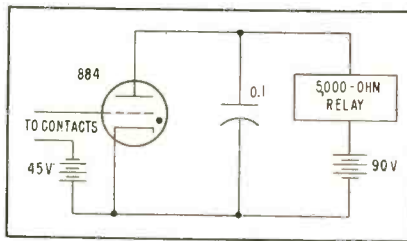

Closing contacts through high resistances extinguishes thyratron to operate relay

voltage is lowered to 90 v and the grid voltage is placed at -45 v by conventional means. When the contact circuit is closed the tube is extinguished by the high negative grid voltage. The circuit will operate without the capacitor shown; but, if a high resistance, such as that of a body, is present in the grid circuit the capacitor must be included. Short circuit grid current is less than one microampere.

Two such circuits have performed continually for a year. The circuit also performs adequately as a drop indicator.

REFERENCE

(1) I. S. Gray, "Applied Electronics", John Wiley & Co., New York, 1954.

Printed Circuit Microwave Attenuator

By JOHN W. FALLON
Sanders Associates, Inc.
 Nashua, N. H.

THREE basic types of attenuating devices are available for varying continuously the attenuation of a microwave signal. These are (1) coaxial, (2) waveguide and (3) cut-

off, the last being essentially a combination of (1) and (2). Each of these has its own inherent limitations with respect to one or more of the following: frequency range,

Megawatt Broadcast Beam Triode

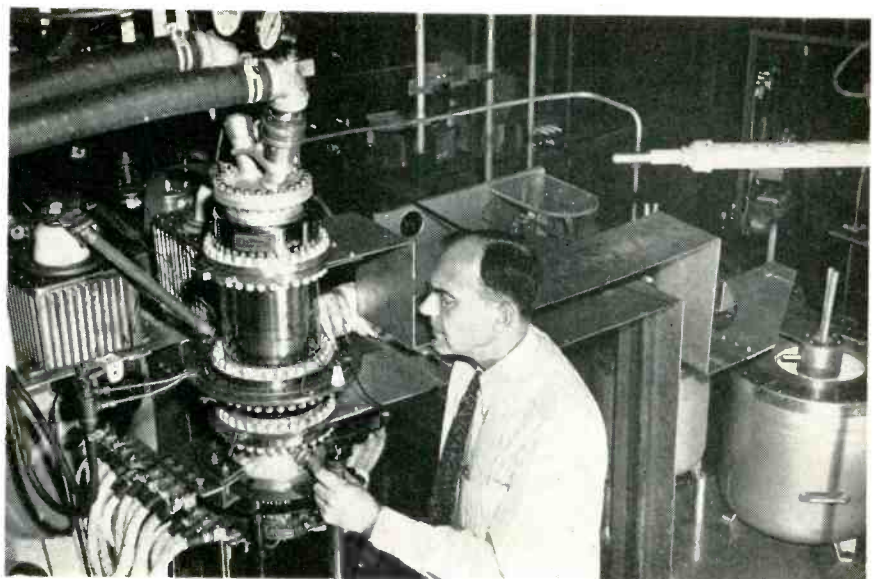

A new developmental tube undergoing test is RCA's type 5831 said to operate at a megawatt of power input through the standard broadcast band and even higher without reducing plate voltage

Up A Custom Cable Tree, Engineer ?

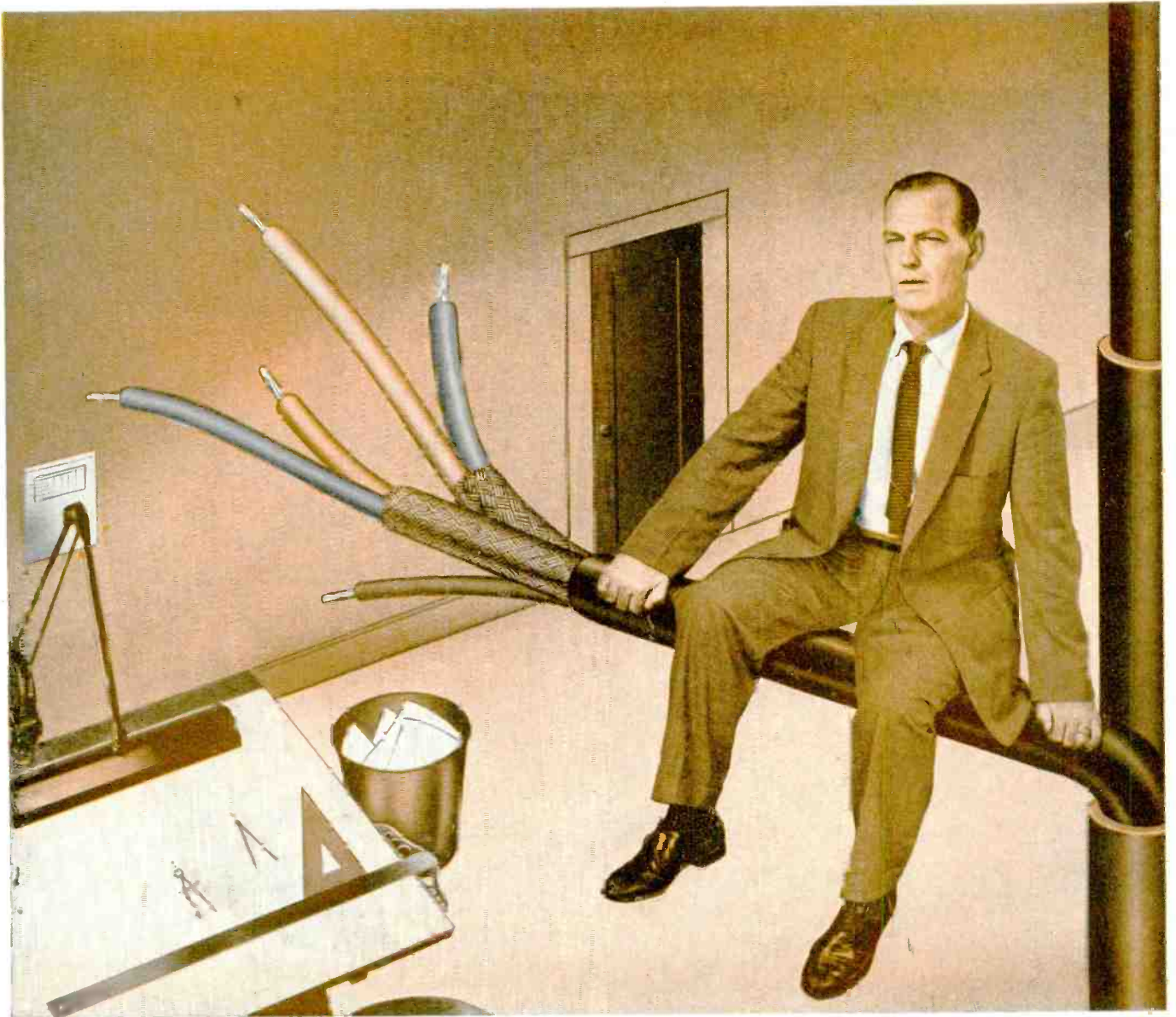

PHALO Will Bring You Down!

You're an engineer . . . darn good one too — yet this custom cable problem has you way up in a tree!

But are you discouraged? Well, yes, honestly you are . . . then you have a flash PHALO — Call PHALO.

So you do and like so many other engineers

who found themselves hanging by a cable problem . . . you're suddenly off the hook!

*Your First Step —
Get This Catalog!*



-PHALO

PLASTICS CORPORATION

Corner of Commercial Street

WORCESTER, MASSACHUSETTS

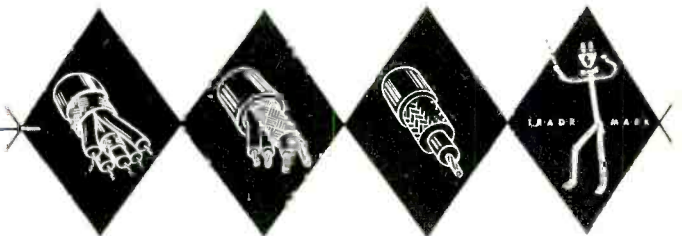

insertion loss, radiation leakage, vswr, simplicity of construction and operation, size, weight and form factor. By rotating a resistive card between the two center conductors of a strip-type transmission line, these limitations have been appreciably reduced.

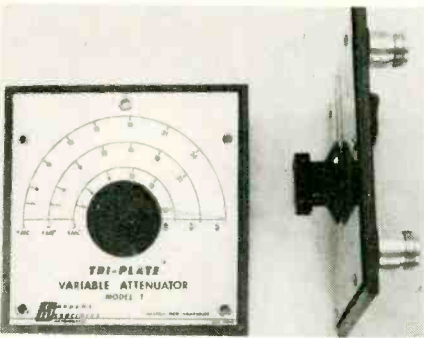

Front and side views of the attenuator

The transmission line used in the device described consists of a sandwich of metal foil and dielectric filling. It is formed from two thin sheets of dielectric, each of which has a copper film bonded to both its faces. Identical circuitry is etched on one face of each sheet, and the etched faces are placed together. Screws and eyelets that

give mechanical support to the sandwich also act as shorting bars to force the two outer faces to remain at equal potential, thereby minimizing radiation leakage.

In the Tri-Plate variable attenuator, the two center conductors of the transmission line are separated by a dielectric spacer to permit insertion of the resistive card. By rotating this card, varying degrees of attenuation are obtained.

The attenuator is designed for optimum performance at 4,000 mc where the vswr is a maximum of 1.25 and attenuation is 20 db but

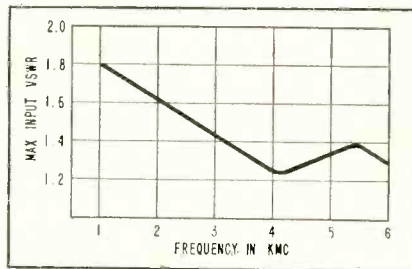

Characteristic of the attenuator in terms of vswr vs frequency

the dial is also calibrated to indicate approximate attenuation at 3, 4 and 5 kmc.

► **Maximum VSWR**—As shown in the curve, maximum vswr over the operating range between 1,000 and 6,000 mc is 1.8 or less. Leakage is -70 db and insertion loss is less than 1.5 db over the frequency range. The attenuator has a characteristic impedance of 50 ohms and its power rating is two watts.

Certain concessions must be made to provide a simple, reasonable accurate attenuator, variable over a wide range of microwave frequencies, capable of being matched to a low vswr, and having small insertion loss. Coaxial construction will give broadband operation, but it is too complex; the waveguide type is simple enough, but its range is restricted. A combination of the two, such as the loop-type cutoff attenuator, presents high insertion loss and an innately poor match as the price for its extreme accuracy.

Incompatible characteristics of simplicity and broadband performance are combined in this device without sacrificing other vital features. Mechanically this results

C-D Alarm



Warning device shown plugs into any convenience outlet and is activated by signal transmitted through power lines. Developed by Midwest Research Institute of Kansas City, Mo., for mass production and sale at \$5, the unit might be used in 96 percent of homes wired for electricity

SALES OFFICES

ALBUQUERQUE, N. M.
V. T. Rupp Company
8009 Bellamah
Albuquerque 3-3585

ARDMORE, PA.
L. G. White & Company
P. O. Box 224
Midway 2-6505

ARLINGTON, MASS.
Waters and Drew, Inc.
P. O. Box 208
Mission 8-3510

ARLINGTON, TEXAS
George E. Harris & Co.
503 Circle Drive
CR. 4-0761

BALTIMORE, MD.
Airtax Products Co.
Middle River
MURdock 6-9100

CEDAR RAPIDS, IOWA
George E. Harris & Co.
526 Merchants National Bank Bldg.
Cedar Rapids 2-6302

DAYTON, OHIO
S. M. Tettelbaum
1517 Benson Drive
Hemlock 7128

DETROIT, MICH.
Tant Enterprises
16254 Meyers Road
UNiversity 4-0738

FT. MYERS, FLORIDA
Arthur H. Lynch & Associates
P. O. Box 466
Edison 4-4431

KANSAS CITY, MO.
George E. Harris & Co.
701 East 63rd Street
Delmar 9600

LOS ANGELES, CALIF.
V. T. Rupp Company
2230 West 11th Street
Dunkirk 3-4197

MINNEAPOLIS, MINN.
Fred Peterson Company
2431 Hennepin Avenue
FRanklin 7-3025

PORT WASHINGTON, L. I., N. Y.
Cooper-Di Blasi
90 Main Street
PORt Washington 7-0470

ROCHESTER, NEW YORK
Reed-Tollefsen Corp.
2815 Monroe Avenue
Hillside 0450

SAINT LOUIS, MO.
George E. Harris & Co.
7811 Carondelet Street
Volunteer 3-6550

SAN MATEO, CALIFORNIA
Robert Pfeieger Company
28-37th Avenue
Fireside 5-8501

SEATTLE, WASHINGTON
George E. Harris & Co.
444 Dexter Horton Bldg.
Seneca 1673

SILVER SPRING, MD.
L. G. White & Company
8416 Georgia Avenue
Juniper 5-3141

WICHITA, KANSAS
George E. Harris & Co.
3241 East Douglas
Murray 3-9226

WINSTON-SALEM, N. C.
L. G. White & Company
P. O. Box 2356
Winston-Salem 5-3612

EASTERN CANADA
Leonard Electric Limited
346 Bering Avenue
Toronto 18, Canada
Belmont 1-2731

OVERSEAS DISTRIBUTOR
B. Freudenberg, Inc.
240 West 98th Street
New York, New York
UNiversity 5-8975

Design Manufacture Inspection

It takes all three: design, manufacture, and inspection to produce reliable choppers. Airpax chopper design is the result of years of experience with magnetic-mechanical devices. A resonant reed gives Airpax choppers positive contact action. Materials and their shapes are thoroughly considered in the design of these choppers.

Full potentialities of the design are retained in the finished choppers by careful manufacture. Skilled workers using precision machines assemble Airpax choppers in a completely air-conditioned factory.

And to be certain that Airpax choppers are actually as good as they can be, the materials that go into them are inspected before assembly and the completed choppers are inspected after assembly.

For example, the young lady to the right is placing a chopper in a special Airpax life-test rack where the chopper will be operated for at least its rated life. This rack automatically records the performance of this and other choppers at regular intervals. Any irregular behavior or signs of possible incipient failure will be amplified and plotted on the strip chart along with the life lines of other choppers sampled from production.

This record shows, in terms of hour to hour performance, how effective the design and manufacture are. The result is a reliable chopper.

The Result is Reliable Choppers

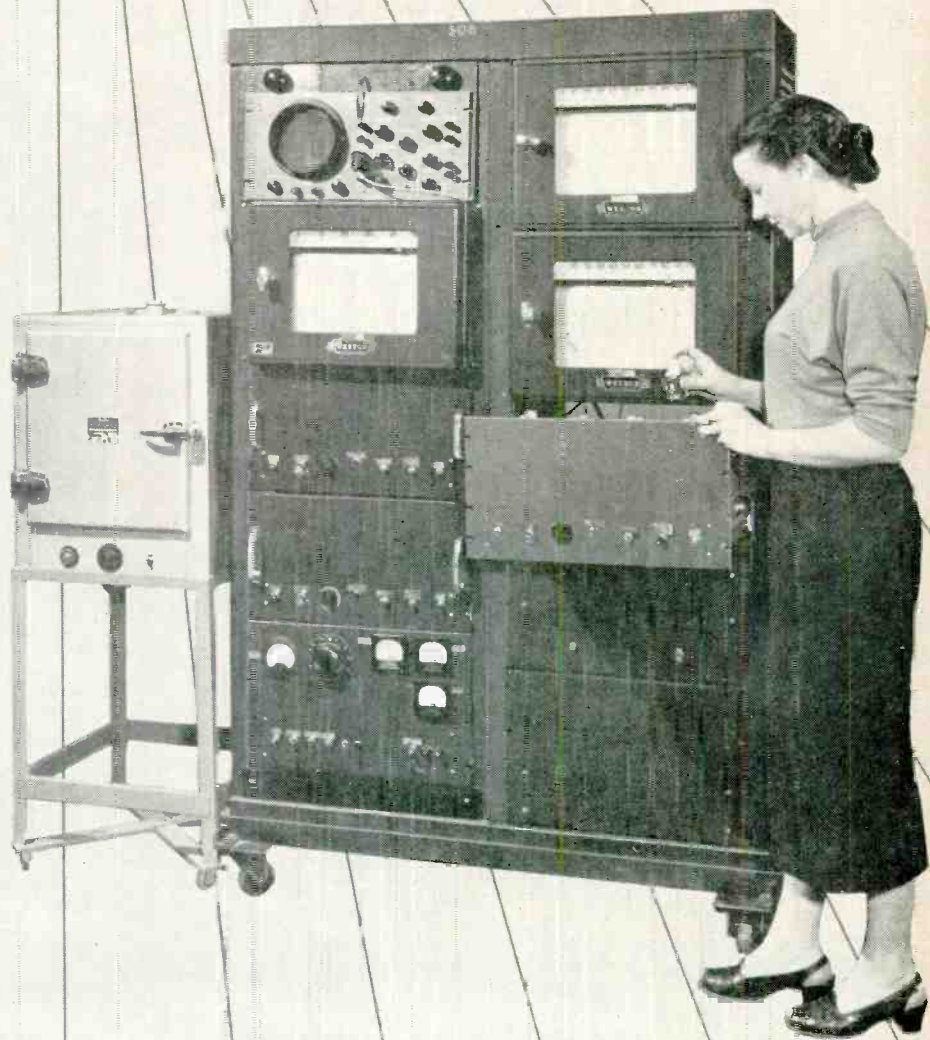

CAMBRIDGE DIVISION, JACKTOWN ROAD, CAMBRIDGE, MARYLAND

DESIGNERS

AIRPAX
PRODUCTS
COMPANY

ENGINEERS

CHICAGO

STOCK MAGNETIC AMPLIFIERS for immediate delivery

SATURABLE TRANSFORMERS DESIGNED TO MEET

Mil-T-27A, Grade 4, Class R
Life expectancy 10,000 hrs. min
Maximum Altitude 50,000 ft.

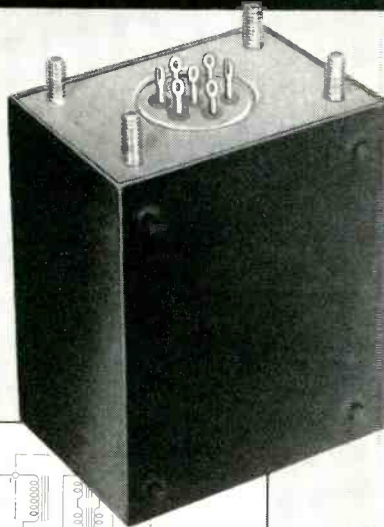

For information on special saturable transformers, designed and built to your specifications, write to Saturable Transformer Engineering Department, Chicago Standard Transformer Corporation.

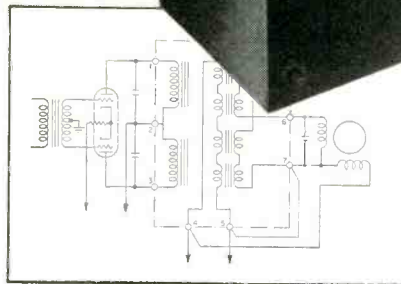

All Primaries 115V., 400 cycles

	STH-3	STH-5	STH-10	STH-18
Power Output in watts	2.7 3.5	5	10	18
Voltage Output, volts	26 115	115	115	115
Load Resistance in ohms	250 3800	2640	1320	775
Tuning Capacitor, MFD	.28 .19	.4	.6	1.0
Primary Current in amps	.085 .1	.13	.24	.35
Control Current, MA	8 8	8	8	8
Control Coil Res. (Per Coil) in ohms	2900 2900	3100	4200	5600
Control Coil By pass Capacitors, MFD	.1 .1	.1	.1	.1
Base Area, Dimensions, in.	1 5/8 x 1 1/8	1 1/2 x 2 1/8	1 3/4 x 2 1/2	2 1/8 x 3 1/8
Height, in.	2 7/8	2 3/4	2 3/8	3 3/8
Mtg. Ctrs., in.	3/4 x 1 1/8	1 x 1 1/8	1 1/4 x 1 1/8	1 1/2 x 2 1/2
Actual Wt., Lbs.	3/4	1	1 1/2	2 1/2
Typical Servo-Motor Load	R-118	R-119-2 R-110-2	R-111-2	R-112-2
Kearfott	—	665-54 665-48	665-53-40 665-41	665-53-44 665-45
G. M. Labs.	—	665-54 665-48	665-53-40 665-41	665-53-44 665-45

SEE CHICAGO TECHNICAL BULLETIN #CT-39 FOR ADDITIONAL INFORMATION

DESIGN WITH STOCK TRANSFORMERS

for fast delivery, economy and proven performance—over 1100 stock units are available from Chicago Standard. Write for free catalogs.

CHICAGO STANDARD TRANSFORMER CORPORATION
3501 ADDISON STREET • CHICAGO 18, ILLINOIS

Export Sales: Roburn Agencies, Inc., 431 Greenwich St., New York 13, N.Y.

from the ease with which it can be made; electronically it is primarily a result of the fact that the TEM mode is the dominant mode in both this type and in coaxial lines.

Rectifier Locomotive

By J. E. WALLACE
General Electric Co.
Erie, Pa.
and
J. L. ZEHNER
General Electric Co.
Schenectady, N. Y.

SUCCESSFUL APPLICATION of standard d-c traction motors on rectified single-phase, 25-cycle power revolves about the need of smoothing the ripple resulting from rectification.

Rectified a-c has been used in industry for many years as a source of power for d-c motors. In these cases, it has been largely derived from multiphase rectifiers operating on 3-phase systems, so that the resulting current is essentially pure direct current with an



New locomotive using ignitron rectifiers to supply d-c to traction motors

insignificant amount of ripple. The ripple in the output of a rectifier operating on single-phase a-c, on the other hand, is of considerable magnitude and has a bad effect on both motor performance and maintenance. Fortunately, this ripple can be reduced by filters of a practical size to a point where it is tolerable.

When a d-c series motor is operated on rectified single-phase a-c, the adverse effect of ripple current appears in three ways: poor com-

Another Hoffman
FIRST!

**SILICON
DIFFUSED
JUNCTION
FULL-WAVE
RECTIFIERS**

Replace
Vacuum tubes 5R4-GY,
5U4G and others, in
most military applications

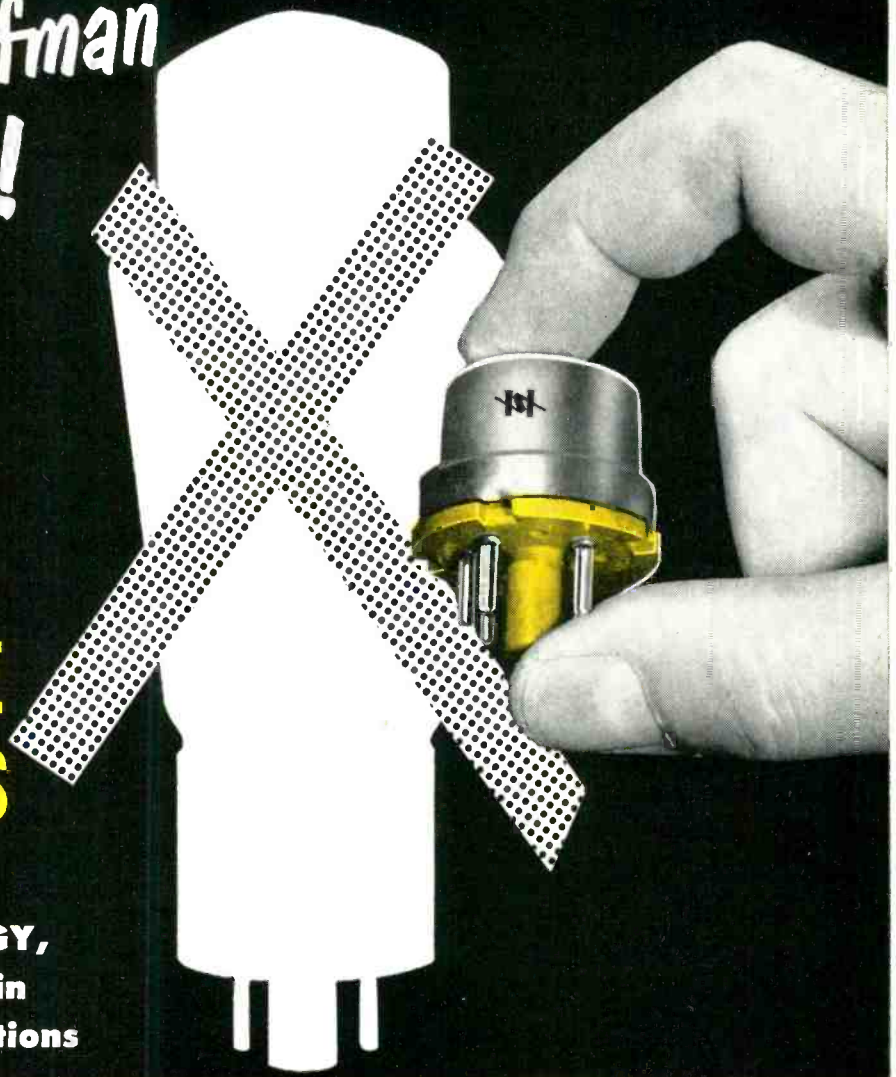

... especially designed to replace, and
exceeds the current ratings of full-wave
vacuum rectifiers 5R4-GY, 5U4G and
others, in critical electronic circuits.

Military applications and equipment (radar,
aircraft, missiles) will benefit from the following
features of HOFFMAN Silicon Diffused
Junction Full-Wave Rectifiers:

- ★ High efficiency (see chart)
- ★ Long life
- ★ Maximum reliability
- ★ Long time stability
- ★ No energy loss in a hot filament
- ★ Small size—for compact design needs
- ★ No maintenance required in critical military circuits



Hoffman Semiconductor Division
formerly National Semiconductor Products
of Hoffman **Electronics Corporation**

930 Pitner Avenue, Evanston, Illinois

COMPARISON OF CHARACTERISTICS

	Peak Inverse Plate Voltage	Max. Average Output Current	Note 2	Typical Rectifier Efficiency*
Hoffman MFWR-1	2100 V	400 ma @ 2100V (Note 1)	430 V 220 ma	98.3%
5R4-GY	2100 V	250 ma	400 V 200 ma	79.5%
5U4-G	1550 V	270 ma	400 V 200 ma	75.5%

Note 1—At 2100 V peak inverse plate voltage, 25°C ambient, with choke input to filter. Max. Avg. output current of 300 ma at 2100 V peak inverse with 12 mfd max. capacitor input to filter.

Note 2—DC output voltage and current when indicated type is substituted in a typical rectifier circuit with choke input to filter. *Operated at 1414PIV into a 1650 ohm Load

We invite your inquiry

MANUFACTURERS:
silicon junction diodes
zener reference elements
medium and high power rectifiers
silicon solar cells

characteristics of the locomotive traction motor are such that the value of the allowable ripple current is constant regardless of the magnitude of the d-c component. This characteristic permits the use of a reactor which saturates with load. The impedance characteristic curve of the smoothing reactor is shown in Fig. 1.

Eddy currents produced by the ripple in the rectified 25-cycle power cause a core loss in the frame which increases the operat-

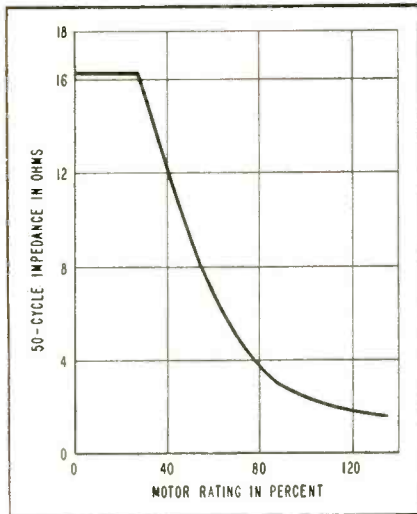
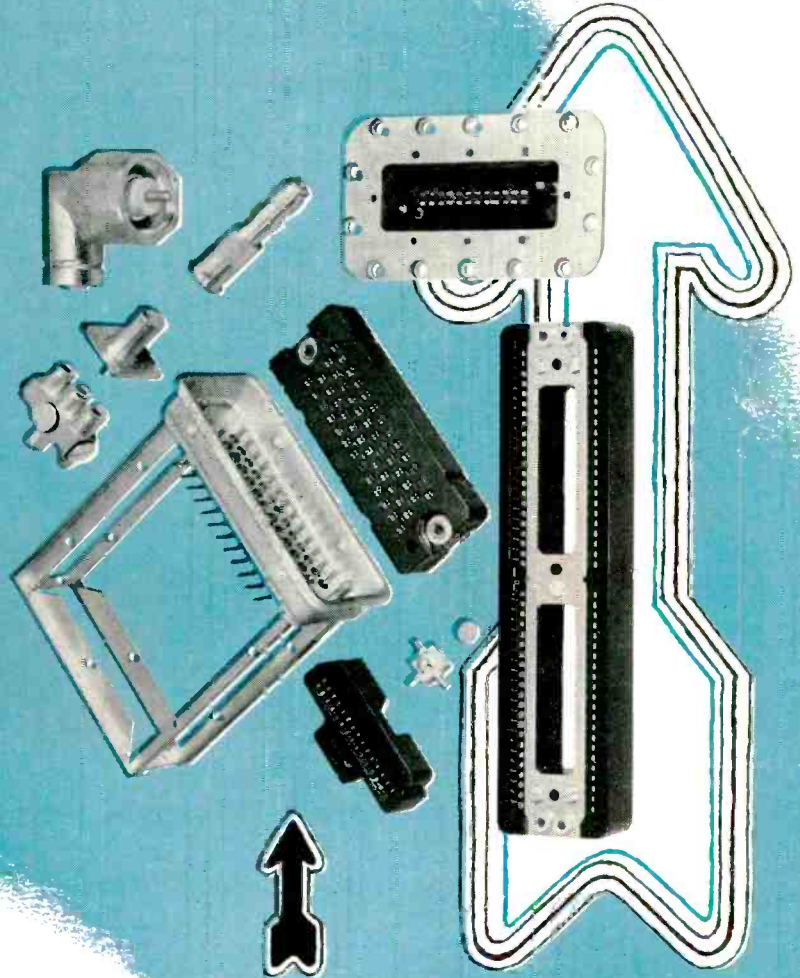

FIG. 1—Impedance characteristics of smoothing reactor used in rectifier locomotives

ing temperature and causes added heating of field windings. The operating temperature of the laminated armature is not noticeably affected by the presence of the ripple current. However, the continuous rating of the fields must be reduced or their allowable operating temperature raised to compensate for the additional motor heating resulting from the additional core loss caused by the ripple current.

Tests indicate that a 50-cycle torque pulsation exists in the shaft of a motor operating on rectified single-phase, 25-cycle power. With solid gears, this torque pulsation is 9 percent of steady-state full-load torque. The substitution of resilient gears will reduce it to 4 percent. The magnitude of the pulsation with solid gears, however, is not great enough to cause mechanical failure, so the additional

a few of the **NEW** ELECTRONIC COMPONENTS to be seen at **AMPHENOL**



On prominent display at AMPHENOL's IRE exhibit this year are **NEW** components of unusual interest: Connectors custom-engineered for production to the most stringent demands of the electronics industry. AMPHENOL research and engineering, responsible for these advanced designs, is always available for the development of special connectors and cable to meet the **NEW** demands of the electronics industry.

You are cordially invited to stop at Booths 2321-2327 to discuss components on display and your component needs with the Sales/Engineers of AMPHENOL.

AMPHENOL ELECTRONICS CORPORATION
chicago 50, illinois

AMPHENOL



expense of resilient gears is not justified.

Smoothing the current supplied to the traction motors tends to cause severe distortion of the primary current wave supplied from the trolley. This distortion sets up conditions of possible telephone influence.

A number of field tests have been made to determine the amount of interference rectifier locomotives generate in adjacent telephone lines. The results indicate that telephone interference is much less than had been anticipated. It has proved of minor importance, especially where telephone lines are run in cable. Moreover, a small R-C filter circuit connected across the input to the rectifier tubes produces a substantial reduction in the noise level.

Rectifiers on locomotives are subjected to very severe operating conditions. The load may vary from zero to maximum almost instantaneously, and large blocks of power, peak outputs of approximately 1500 horsepower per motor for short periods must be handled. To assure proper operation of the tubes under conditions of wide trolley voltage variation, a flexible yet reliable control is required.

It took several years to develop a rectifier tube which meets these

Ultrasonic Cleaner

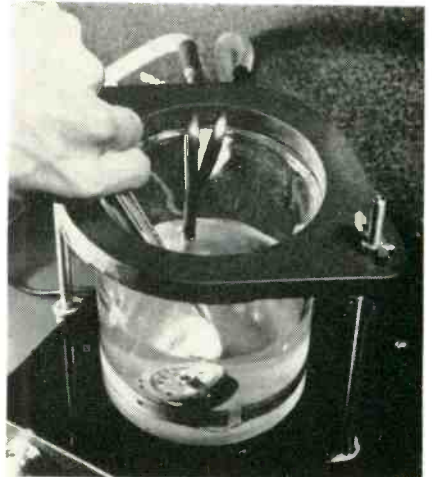

Magnetostriction oscillator produces high-frequency vibrations in cleaning solution. Resultant cavitation or effective scrubbing action removes dirt and foreign particles from gyro assembly at Kearfott plant

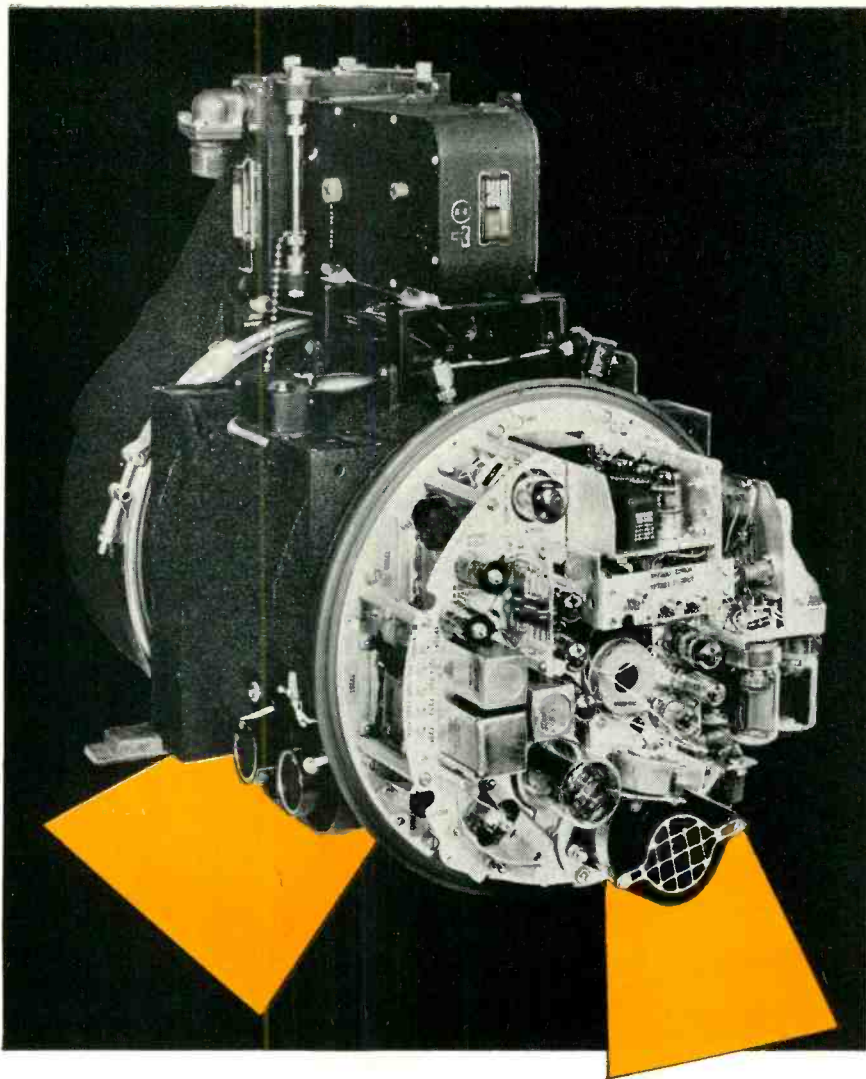

Joy Fans HELP LICK HIGH VOLTAGE ARC-OVER IN AIR-BORNE RADAR UNIT

WHEN MOTOROLA designed this 10 inch air-borne radar indicator to operate at 60,000 ft. they eliminated high voltage arc-over by pressurizing the unit. But this created excessive heat.

TO DISSIPATE HEAT an air-to-air heat exchanger, using three Joy Axivane fans was built in. Two external fans blow outside air between two plates separated by aluminum tubing. Another Joy fan, sealed *inside* the pressurized radar unit circulates hot inside air thru this tubing.

THESE JOY FANS must operate in the wide temperature range of -55°C to $+125^{\circ}\text{C}$. . . tough treatment.

Joy has over 250 models and 1300 designs of these high performance fans ready to solve your toughest air-moving problem . . . be it electronic cooling, de-icing and defogging or ventilation. Write *Joy Manufacturing Company, Oliver Building, Pittsburgh 22, Pa.* In Canada: *Joy Manufacturing Company (Canada) Limited, Galt, Ontario.*

Write for FREE Bulletin 143-39

WSW | 6415-143

JOY...EQUIPMENT FOR AVIATION...FOR ALL INDUSTRY



Ground
Power Units



Portable
Lighting



Electrical
Connectors

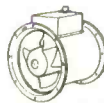

Vaneaxial
Fans

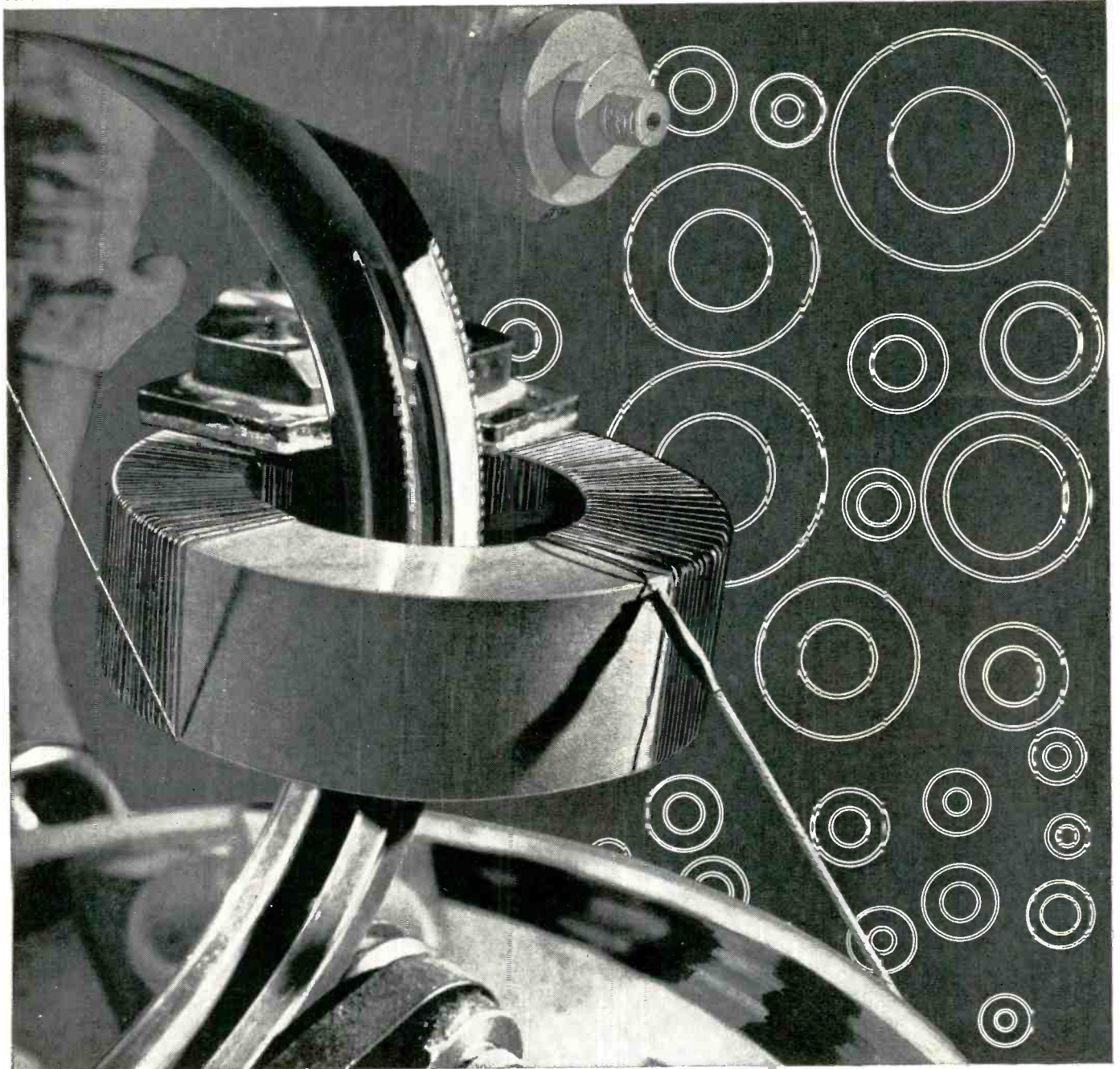

How will tape wound core users be affected by new size standards?

If toroidal core winding is a familiar sight in your plant, you'll welcome news that standard sizes for tape wound cores have been proposed by the A.I.E.E.* You are going to benefit from a high in consistency of core performance, brought about by our being able to concentrate on your most important sizes.

Magnetics, Inc. is now stocking all of the proposed standard core sizes in both aluminum and phenolic core boxes for immediate delivery. Consistency of core performance is increased because each size is made in large lots taken from the same alloy batch and dry hydrogen anneal. They all bear our exclusive Performance-Guarantee.

You can find all specifications for these AIEE-standardized tape wound cores in Catalog TWC-102, a new publication

which, incidentally, is the most comprehensive tape wound core text published anywhere by anybody. Your copy of this Catalog-Design Manual may be obtained by writing on your letterhead to *Magnetics, Inc., Dept. E-34, Butler, Pa.*

MAGNETICS inc.

**Paper 57-206, Proposed Size Standards for Toroidal Magnetic Tape Wound Cores. Report of the Magnetic Amplifiers Material Sub-Committee, at the 1957 Winter General Meeting, A.I.E.E.*

Celco TOROIDS

... Offered in a
wide range of sizes

#50 wire on .062" ID
#15 wire on 9" OD



Whether it's a complex 10 winding magnetic amplifier or a simple choke . . . at Celco each toroid is precision-made. New core materials are used in Toroidal magnetic amplifiers, reactors and transformers to achieve maximum performance.

At Celco, the proper matching of cores, winding, handling, impregnation, encapsulation and electrical history of the final assembly is carefully controlled to maintain the original design characteristics.

Our years of design, development, and production know-how are available for application to your specific TOROIDAL problems.

For immediate attention, call Ramsey
9-1123 — or write today.

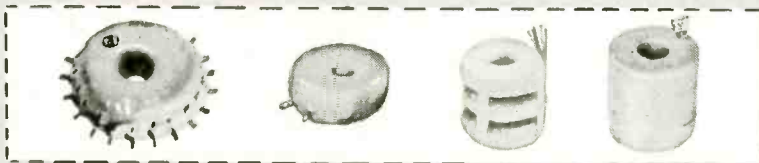

Celco

MAHWAH, N. J.
RAMSEY 9-1123

Constantine
Engineering Laboratories Co.



Your plant is only hours away by the Celco Air Fleet!

requirements. The tube used in the New Haven locomotives and shown in the photograph is a GE type GL-6504 locomotive ignitron. It has two grids to ensure high commutating ability at high currents and high voltages. A special baffle was designed for use in the mercury pool cathode to ensure reliable ignition of the arc in spite of vibration.

The cathode connection is made at the top of the enclosing cylinder so that the cylinder forms a concentric conductor of current to the

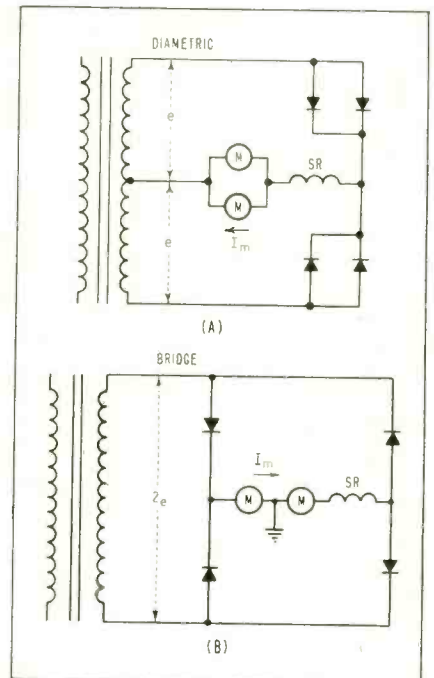

FIG. 2—Diametric (A) and bridge (B) type connections for locomotive drive motors

cathode pool, thereby reducing the magnetic fields set up inside the tube by this current. Reduction of the effect of magnetic fields on the arc stream in high-power rectifier tubes is an important factor contributing to their long life expectancy.

There are two types of rectifier connections which could be used for converting alternating to direct current. The first is the diametric connection, and the second is the bridge or 2-way connection. The principal elements of these types are shown in Fig. 2.

The diametric connection is economical of rectifier tubes at the expense of transformer weight and cost. The transformer must be

WESTERN UNION TELEGRAM

DL = Day Letter
 NL = Night Letter
 LT = International Letter Telegram
 1220 (R 11-54)

CLASS OF SERVICE
 This is a fast message unless its deferred character is indicated by the proper symbol.

The filing time shown in the date line on domestic telegrams is STANDARD TIME at point of origin. Time of receipt is STANDARD TIME at point of destination.

PA158
 NA152 PD=WUX PHILLIPSBURG NJER 28 435PME=

GOOD NEWS FOR SEMI-CONDUCTOR MANUFACTURERS. SPECIFICATIONS TO ASSURE THAT COPPER AND NICKEL EACH WILL BE LESS THAN 0.5 PPM ARE NOW INCLUDED AMONG THE MANY OTHER CONTROL TESTS FOR BAKER REAGENT HYDROFLUORIC, NITRIC, ACETIC, HYDROCHLORIC AND SULFURIC ACIDS. ANALYSES SHOW THAT BAKER REAGENT ACIDS REGULARLY HAVE MET THESE ADDITIONAL REQUIREMENTS. TOTAL HEAVY METALS ARE TYPICALLY LESS THAN 1 PPM. THESE BAKER REAGENTS ASSURE YOU BETTER PROCESS CONTROL OF ETCHING OPERATIONS. ORDER BAKER REAGENTS ACIDS-- TESTED AND LABELLED TO PROVIDE YOU THE SECURITY OF CONSISTENTLY HIGH PURITY-- PREMIUM QUALITY WITH NO PREMIUM IN PRICE--

J T BAKER CHEMICAL CO PHILLIPSBURG NEW JERSEY=

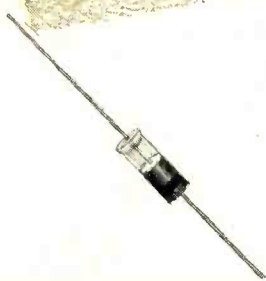
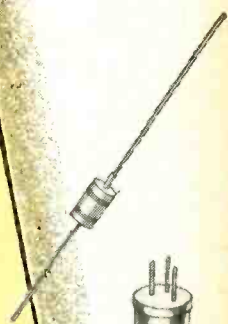

SEMI-CONDUCTOR CHEMICALS

- | | |
|----------------------|--------------------------------|
| Acetic Acid, Glacial | Hydrogen Peroxide 30% Solution |
| Acetone | Methanol |
| Ammonium Hydroxide | Nitric Acid |
| Carbon Tetrachloride | iso-Propyl Alcohol |
| Chloroform | Sodium Carbonate |
| Ether, Anhydrous | Sodium Hydroxide |
| Hydrochloric Acid | Sulfuric Acid |
| Hydrofluoric Acid | Xylene |

OTHER ELECTRONIC CHEMICALS

- | | |
|--------------------|---------------------|
| Acetic Acid | Lithium Carbonate |
| Aluminum Nitrate | Lithium Nitrate |
| Aluminum Sulfate | Lithium Sulfate |
| Ammonium Carbonate | Magnesium Carbonate |
| Ammonium Chloride | Magnesium Chloride |
| Ammonium Phosphate | Magnesium Oxide |
| Antimony Trioxide | Manganous Carbonate |
| Barium Acetate | Methanol |
| Barium Carbonate | Nickelous Chloride |
| Barium Fluoride | Nickelous Nitrate |
| Barium Nitrate | Nickelous Sulfate |
| Benzene | Nitrate & Oxide |
| Boric Acid | Nitric Acid |
| Cadmium Chloride | Potass. Dichromate |
| Cadmium Nitrate | Potass. Hydroxide |
| Cadmium Sulfate | Radio Mixtures |
| Calcium Carbonate | Silicic Acid |
| Calcium Chloride | Sodium Chloride |
| Calcium Fluoride | Sod. Phos. Dibasic |
| Calcium Nitrate | Strontium Nitrate |
| Calcium Phosphate | Sulfuric Acid |
| Ether, Petroleum | Toluene |
| Hydrochloric Acid | Triple Carbonate |
| Lithium Chloride | Zinc Chloride |

FOR SEMI-CONDUCTORS

These new control tests for copper and nickel have a double significance for the manufacturers of electronic components. They prove that:

1. Baker reagent purity regularly offers the quality-plus needed for semi-conductor manufacture.
2. As the electronics industry is able to define its needs more precisely, Baker will continue to provide material meeting the required specifications.

Listed at the left are some of the other Baker high purity chemicals of particular importance to electronic manufacturers.

J. T. Baker Chemical Co.
 REAGENT • CHEMICALS • FINE • INDUSTRIAL
 Phillipsburg, New Jersey

Thor for STEATITE and EPOXIDE RESIN INSULATORS

- LOW LOSS FACTOR
- HIGH DIELECTRIC STRENGTH
- QUALITY CONTROL TO GOVERNMENT SPECIFICATIONS



YOU CAN SAVE MONEY and get speedy deliveries on custom-made epoxide and steatite bobbins because THOR CERAMICS is a specialist in this field . . . supplying most of the nation's leading bobbin users.

Leaders in the electronic field specify THOR for their steatite EXTRUDED, PRESSED and MACHINED parts. That's because THOR has the production "know-how" for producing standard and custom-made items to Jan-I-10 or customers' specifications for insulators, metalizing and close tolerance ground parts. Let us quote on your requirements.

Thor Ceramics, Inc.

225 Belleville Avenue, Bloomfield, New Jersey

Visit Booth #4216 I.R.E. Show, March 18-21, 1957

wound for twice the voltage of the output circuit, since the current flows alternately in the two halves of the secondary winding as first one and then the other set of tubes conducts.

During the commutating period of the rectifier, current flows in all tubes and the entire secondary of the transformer is short circuited. When the nonconducting tubes start to conduct, the short-circuit current begins to build up. When it reaches half the value of the output current, the currents in the two sets of tubes are equal. Hence, the currents flowing in the two halves of the transformer secondary, being in opposite directions, result in zero net secondary ampere turns, and hence zero primary current.

The build-up continues until the current in the second set of tubes equals the output current and commutation is complete. The algebraic sum of the short-circuit current and the current originally flowing in the first set of tubes is then zero, since these currents flow in opposite directions, and current ceases to flow in the first set of tubes.

In the bridge connection, the

Small Missile Recorder



Tiny tape recorder solves problem of collecting areodynamic data from missiles too small for telemetering equipment. Developed by North American Instruments, Inc., the unit has been used to obtain skin temperatures during high-speed, high-altitude flights of a hypersonic test vehicle that reached 5,000 mph at approximately 50,000 feet. In tests at Holloman Air Development Center, N. M., one recorder was recovered and reused eight times. Other uses included testing missiles and free-flying models in wind tunnels

How to use a Wave Analyzer on an Ocean Wave

(or any low frequencies from 1/10th to 5 cycles per second)

A head-on attack on this problem will soon uncover the disconcerting fact that wave analyzers just don't come this big. Those of a more comfortable size generally operate on frequencies of five cycles per second and more.

But frequencies as low as 1/10th cycle per second — like earthquake waves, ship motion, and low-frequency vibrations of large machines and structures can be fed to conventional wave analyzers with completely satisfactory results. Magnetic tape recording provides an essential conversion step between.

Two Ampex FR-100 magnetic recorders were purchased and installed aboard the SS Mariposa for Bell Aircraft Corporation's study of ship motion at sea. The frequencies encountered were far below one cycle per second. These were recorded at the lowest tape speed on the recorder (1½ in/sec.). Reproducing the tape at the highest tape speed (60 in/sec.) multiplied the frequencies by 32. Recopying onto the second recorder and speeding up again increased the total speedup to 32 x 32 or a total of 1024. As an example, a frequency of 1/10th cycle per second became approximately 100 cycles per second and was easily separated and measured by wave-analysis equipment.

The Ampex FR-100 recorder has six standard speeds from 1½ to 60 in/sec. in the ratio of 1, 2, 4, 8, 16 and 32. Recopying accomplishes further multiplication by powers of two. Even a second recopying is perfectly feasible just in case you are interested in a frequency multiplication of 32,768.

Putting low frequencies onto magnetic tape requires an FM-carrier recording. On the Ampex FR-100 this is conveniently provided by plug-in amplifiers. Frequency response at 1½ in/sec. tape speed is 0 to 312 cycles/sec. At 60 in/sec. it is 0 to 20,000 cycles/sec. Besides its ability to record very low frequencies, FM carrier recording has the very

desirable attribute of high instantaneous amplitude accuracy. Thus, the reproduced waves retain their original form very accurately through any amount of speedup.

If you have a problem that might be solved by data speedup, we would be pleased to furnish further information. Others of magnetic tape's remarkable capabilities will be the subjects of a continuing series of these bulletins. Would you like copies mailed direct? Write Dept. E-3134.



Bell Aircraft Corporation's magnetic-recorder installation aboard the SS Mariposa for study of ship motion.



Speed change on the Ampex FR-100 is accomplished quickly and easily by a selector knob and switch.

MAGNETIC
TAPE
APPLICATIONS
BY AMPEX

ONE OF A SERIES



Series FR-100



Series 800 Mobile and Airborne



Model FR-200 Digital



Tape Loop Recorder



Series FR-1100

INSTRUMENTATION
DIVISION

AMPEX
CORPORATION

FIRST IN MAGNETIC TAPE INSTRUMENTATION

934 CHARTER STREET • REDWOOD CITY, CALIFORNIA

District offices serving all areas of the United States and Canada; Foreign Representatives in countries around the world.

Visit us at
BOOTH 3229 · IRE SHOW
MARCH 18-21, 1957 · NEW YORK COLISEUM

PHAZOR PHASE METERS

A PRECISION PHASE MEASURING INSTRUMENT

MODEL 200 A

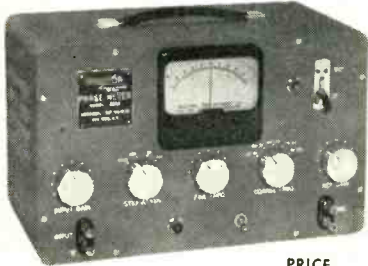

PRICE
\$349.50

• HIGH ACCURACY • MEASURES FROM 0 TO 360 DEGREES • READINGS NOT AFFECTED BY NOISE AND HARMONICS • PHASE SHIFTS OF THE ORDER OF .01° CAN BE MEASURED EMPLOYING SPECIAL CIRCUIT TECHNIQUES • MEASURES IN-PHASE AND QUADRATURE COMPONENTS SEPARATELY

SPECIFICATIONS

Accuracy..... ± 2 degrees
 Noise and Harmonic Rejection..... 40 DB down
 Sensitivity..... 6 millivolts full scale
 Frequency Range..... 20 to 20,000 C.P.S.
 Power Supply..... 105-125 Volts, 60 C.P.S.,
 Dimensions..... 9 x 15 x 8 inches

IMPEDANCE COMPARATORS

FOR LABORATORY AND PRODUCTION IMPEDANCE TESTING

• TESTS RESISTORS, CONDENSERS, INDUCTORS • PERCENTAGE DEVIATION FROM STANDARD READ ON LARGE METER • RAPID RESPONSE — NO BUTTONS TO PUSH • HIGH ACCURACY AND STABILITY • SELF CALIBRATING — REQUIRES NO RECALIBRATION WHEN CHANGING RANGES

SPECIFICATIONS

Bridge Supply Volts..... 2 volts
 Component Voltage At Balance..... 1 volt
 Frequency..... Either 1,000 C.P.S., or 10,000 C.P.S.
 Full Scale Ranges..... ± 5%, ± 10%, ± 20%
 Component Test Ranges:
 Resistance..... 5 ohms - 5 megohms
 Capacitance..... 50 mmf - 20 mfd
 Inductance..... 100 microhenry - 80 henries
 Power Supply..... 105 - 125 volts, 60 C.P.S.
 Dimensions..... 9 x 15 x 8 inches

MODEL 1010



PRICE
\$299.00

POWER OSCILLATORS

A COMPACT PRECISION OSCILLATOR PROVIDING 3 WATTS OUTPUT

MODEL 1040



PRICE
\$119.00

• EXCELLENT ACCURACY AND STABILITY • TRANSFORMER ISOLATED OUTPUT • 3 OUTPUT IMPEDANCES • LOW INTERNAL IMPEDANCE • OUTPUT VARIABLE UP TO 120 VOLTS

SPECIFICATIONS

Frequencies..... 400 or 1000 C.P.S. by selector switch (other frequencies on request)
 Distortion..... Less than 1%
 Hum Level..... Approximately .05% of rated output
 Output Power..... 3 watts into matched resistive load
 Power Supply..... 115 volts, 60 C.P.S., 40 watts
 Dimensions..... 5-11/16 x 9 x 6 1/8 inches

Manufacturers of:

PHASE METERS • NULL DETECTORS • IMPEDANCE COMPARATORS
 POWER OSCILLATORS • FREQUENCY STANDARDS • AUTOMATIC HI-POT

Other Electronic Test Equipment

For further information contact your nearest representative or write for brochure

INDUSTRIAL TEST EQUIPMENT CO
55 EAST 11th STREET • NEW YORK 3, N. Y.

tube action and currents flowing during commutation are much the same as for the diametric connection, except that the secondary winding of the transformer has the same voltage as the output circuit, and the current in the winding flows alternately in the two directions. Since the secondary winding of the transformer carries current during the entire cycle, the transformer is utilized to the fullest extent.

On the other hand, when using the diametric connection, two secondary windings are required, and each carries current for only half of the time. This means that there must be 40 percent more copper in the secondary winding of a diametric-connected transformer than for a bridge-connected transformer. As a result, the transformer as a whole has approximately 20 percent more kva and 10 percent more weight.

► Duty Time—Per rectifier tube it is the same for either of the two connections, provided the motor circuits are connected so that the output voltage of the diametric circuit is one-half that of the bridge circuit. This does not consider fault currents. When a tube arcs back, the arc-back current will be one-third greater for the diametric connection than for the bridge.

The bridge connection provides advantages desirable for locomotive design to insure maximum performance with minimum weight and cost.

One of the most important control considerations of a rectifier locomotive is to insure that the tubes will fire over a wide range of trolley voltage. Ignitron rectifiers require pulsed firing voltages to start tube conduction at the beginning of each half cycle. The firing circuits which provide this voltage are supplied from the same source as the power to the rectifier tubes. Because unusual conditions may result in low trolley voltage, it is essential that the firing circuit be designed to provide for locomotive operation over a relatively wide range of voltage. Firing circuit operation is complicated by the fact that rectifier commutation involves a system short circuit

INSIDE PERFORMANCE

OUTSIDE PROTECTION
against water, vapor,
dust and time

POTPOT*

POTENTIOMETERS

Select that Clarostat standard wire-wound or composition-element potentiometer (Series 10, 48M, 49M, 43, 37, 51 or 58) for superlative electrical and mechanical characteristics.

Then, if you wish a water- and vapor-tight housing, have it encapsulated. That's the Clarostat POTPOT encapsulated control. Completely sealed with exception of external shaft assembly and terminal ends. Special water-tight provision for shaft. Meets MIL-STD-202 Test Specification. Also necessary salt-spray, humidity and temperature cycling requirements of MIL-E-5272.

TECHNICAL DETAILS ON REQUEST



*Reg. U.S. Pat. Off.

CLAROSTAT MFG. CO. INC., DOVER, NEW HAMPSHIRE
In Canada: Canadian Marconi Co., Ltd., Toronto 17, Ont.

New twist in testing ... a torsional exciter

TORSIONAL testing has been done with rectilinear motion shakers by applying ingenuity in linking table to specimen. But here's a new MB exciter that produces torque *directly*. Its performance characteristics permit you to use it as a *calibrator* for torsional pickups and accelerometers . . . as well as for testing gyros and relays (as examples), or checking torsional vibrations of armatures, or determining torsional modes in various rotating parts.

OPERATING FACTS

At free-table, no load, this MB Model CA 1050 Exciter oscillates at up to 1600 cps without resonance in moving elements. It develops 110 ft. lbs torque, which produces angular accelerations as high as 1570 radians/

sec./sec. Maximum total displacement is 45°

A MATCHED SYSTEM

Any one of several MB electronic power supplies drives the equipment, depending on the specific frequency range, power, and performance you want. The MB Model T51 Power Supply shown comes with automatic cycling controls if desired.

SEND FOR DETAILS

Technical data available. And for more information on how and where to use this unusual equipment, contact our staff of vibration specialists. You can't come to a better qualified authority on the subject . . . nor to one more willing to help on your specific vibration testing problems.



manufacturing company

A DIVISION OF TEXTRON INC.

1075 State Street, New Haven 11, Conn.

HEADQUARTERS FOR PRODUCTS TO ISOLATE . . . EXCITE . . . AND MEASURE VIBRATION

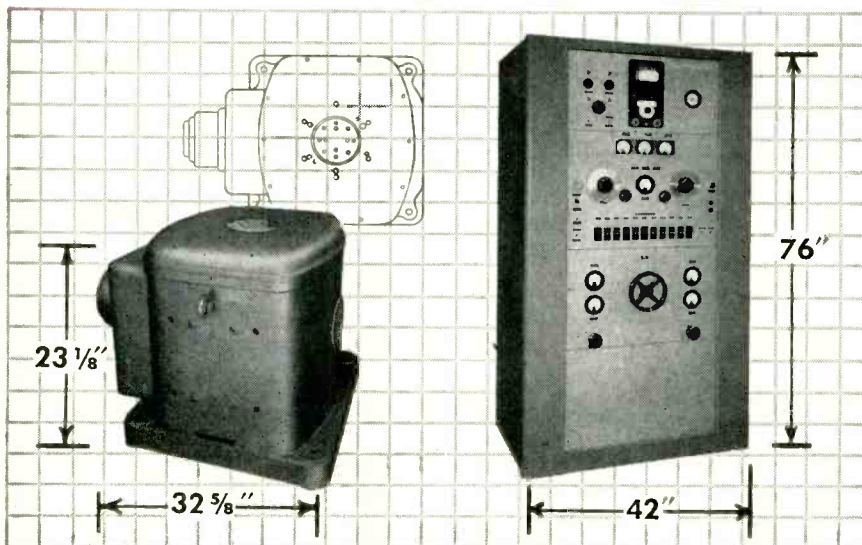

during the commutation period. The result is that a notch is cut into the applied voltage wave as supplied to all rectifiers on the line at any given time. This commutating notch becomes worse as the supply voltage falls and with any increase in trolley circuit reactance as the locomotive traverses the line.

To insure that the rectifiers will continue to operate under all reasonable low-voltage conditions, the excitation circuits are designed to provide a firing pulse of long duration. This insures firing circuit stability and makes them capable of operating over the desired voltage range.

Ignition of the rectifier may be prevented by short-circuiting the firing circuit output by a high-speed relay. By connecting the relay to suppress ignition in the event of a tube arcing back, the normally conducting tubes may be prevented from feeding current into the faulty tube for more than one-half cycle. Arc suppression thus provides rapid interruption of arcbreak current and reduces the duty-time on tubes, transformer and contactors during faults.

Movable-Anode Tube

BLOOD pressure measurements and a correct reproduction of pressure variations are of importance in biology and medicine. The principle of the manometer described here is a transmission of the pressure variations acting on the membrane into variations of an electric current. This is accomplished by means of a mechanoelectronic transducer tube, RCA type 5734.

This subminiature triode has a movable anode with a small extension shaft protruding through the center of a thin air-tight metal diaphragm. An angular displacement of the anode shaft will change the distance between the anode and cathode causing a change of anode current.

The transducer tube housing is directly joined with the membrane housing as shown in Fig. 1. The housing consists of a cone shaped hydrodynamic chamber and the

Having your
ups
and downs?



... if they involve Deposited Carbon Resistors

DALOHM has the answer!

All Dalohm products are carefully designed and skillfully made to assure you of supreme quality and dependability, plus the widest versatility of application.

Outstanding examples of the Dalohm line are these deposited carbon resistors, made for accurate performance where carbon composition resistors are not suited or wire wound resistors too expensive.

You Can Depend On

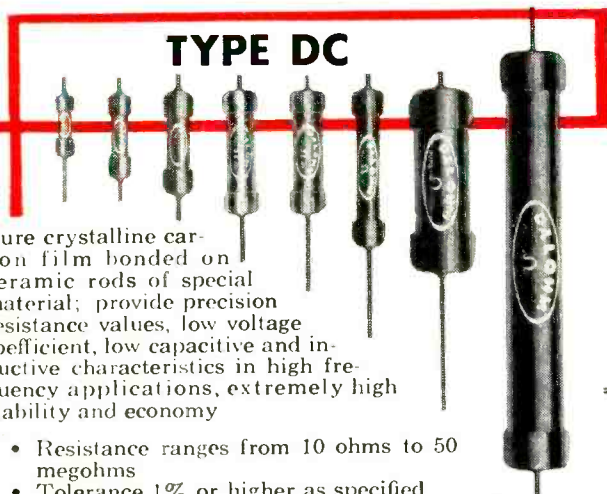

TYPE DC

Pure crystalline carbon film bonded on ceramic rods of special material; provide precision resistance values, low voltage coefficient, low capacitive and inductive characteristics in high frequency applications, extremely high stability and economy

- Resistance ranges from 10 ohms to 50 megohms
- Tolerance 1% or higher as specified
- Five wattages— $\frac{1}{8}$, $\frac{1}{4}$, $\frac{1}{2}$, 1 and 2; eight physical sizes

Write for Bulletin R-24A



TYPE DCH

Essentially the same as type DC except hermetically sealed in a non-hygroscopic ceramic envelope to provide absolute protection against thermal shock, salt water immersion and humidity.

Write for Bulletin R-27A



TYPE DC-5

For extremely high resistance where maximum stability is a prime factor in high voltage applications. Powered at 5 watts; high voltage up to 20,000 VDC; resistance range 1 megohm to 200 megohms; tolerance 1% or up to 10% on request.

Write for Bulletin R-28

**See It
At The
I.R.E. Show**

You can see the complete line of DALOHM precision resistors, potentiometers and collet-fitting knobs, including the products depicted above, at the I. R. E. Show in New York, March 18-21.

You are cordially invited to stop at the Dale Products, Inc. booth, Number 2742-2744. We'll be looking for you.

DALE PRODUCTS, Inc.

1300 28th Avenue Columbus, Nebraska, U.S.A.

• In Canada: Charles W. Pointon, Ltd.
6 Alcina Ave.
Toronto, Ont.

• Export Dept: Pan-Mar Corp.
1270 Broadway
New York 1, N. Y.

connection tube. This tube is connected to the artery or vein under observation by a hollow needle.

The movable-anode tube is placed somewhat off-center in relation to the membrane to enable the pin to rest in the center of the membrane. The pin and the membrane are adjusted to impart to the anode shaft a degree of deviation from its neutral position.

Maximal angular displacement from that position when in opera-

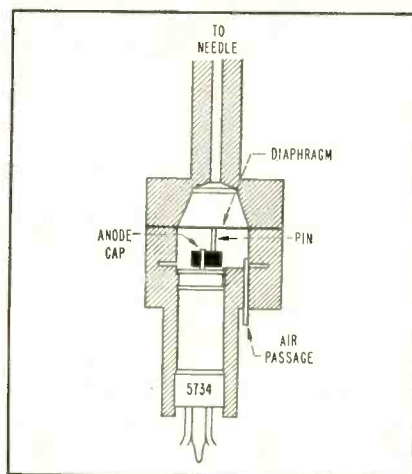

FIG. 1—Cross-section of pressure chamber. Tube anode is connected to diaphragm by pin

tion is 0.15 deg in either positive or negative direction. Through its strong tendency to return to its neutral position the anode therefore always presses the pin firmly against the membrane and will correctly follow the movements.

The membrane is made of platinum and has a free diameter of 12 mm and a thickness of 0.2 mm. The sensitivity of the system is so high that a deflection of the membrane of only 10^{-5} mm will be recorded.

The output voltage of the transducer tube is large enough to simplify amplification. The working properties of the transducer tube, however, make an amplification necessary to get complete linearity of the response curve. With an anode voltage of 250 v and an anode load resistance of 75,000 ohms this is attained, but the relatively large anode dissipation causes overheating, owing to the thermal insulation of the tube housing. Lowering anode load

Complementing

the most sensitive design.

JEWEL

BEARINGS

by

Bird



No matter how exacting the conditions,

Bird **JEWEL BEARINGS**
ASSEMBLE MORE READILY and
FUNCTION MORE EFFICIENTLY.

A variety of settings and mounts, plus a wide range of sizes (stock sizes, or to specification), enables these high-precision elements to be ideally incorporated.

In addition, various settings and cushioning methods — silicon rubber, spring, or friction settings — provide maximum protection for bearings subject to severe shock conditions, yet permit controlled jewel movement, thus ending lost time for tear-down and readjustment.

Of particular advantage are the complete jewel assemblies, set in screws or bushings, which Bird provides in standard sizes or to your specifications. These assemblies greatly reduce overall cost by eliminating rejects, stopping waste, and cutting assembly time. Prove these advantages in your own plant. Forward a print to us with specifications — we'll provide you with testing samples.

For information on Bird Jewels write for Bulletin 14

Over 40 years of serving Industry with Quality Jewel Bearings

*Stringent
quality control methods,
exact tolerances and
design features insure*

- ✓ **LASTING PRECISION PERFORMANCE**
- ✓ **LONGER INSTRUMENT LIFE**
- ✓ **VERSATILE ADAPTABILITY**

Richard H. Bird & Co., Inc.

SAPPHIRE AND GLASS JEWELS, PRECISION GLASS GRINDING,
JEWEL MOUNTING AND ASSEMBLY, SAPPHIRE STYLII
1 Spruce Street, Waltham 54, Mass.

MICROWAVE PROGRESS

Frequency Measurement Devices

A couple of years back, it seemed to us that there were almost as many frequency measuring devices as frequencies. Anticipating that, sooner or later, some sort of definitive material would be needed, our engineer, Bob Lebowitz, consolidated the scattered, available information into his excellent report, "Frequency Measurement Devices"

This report provides a valuable summary of the various equipment types for measuring frequencies in the 300 to 40,000 mc/s range, and a succinct reference source for their respective design considerations and applications. It covers coaxial and cylindrical cavity wavemeters; crystal oscillator frequency standards; and use of stable reference spectral lines.

Most of the commercial requirements for precision are met by open circuited coaxial and right cylindrical waveguide cavities. Since the $\lambda/4$ and $3/4\lambda$ coaxial cavities can be made smaller than right cylindrical waveguide cavities, they are generally preferred for lower microwave frequency measurements. To overcome the critical design problem of contacting the movable plunger without introducing contact resistance in coaxial frequency meters, it has been found more satisfactory to use a non-contacting choke system rather than shorting fingers.

Broadband cavity frequency meters have accuracies that vary between .01 and 1%. For accuracies greater than .001%, low frequency quartz crystal standards are utilized. For microwave applications, multiplying and heterodyning means are required to compare the l.f. frequency oscillator signal with the signal of unknown frequency.

Although we've tried to cover most of the aspects of Bob Lebowitz' report in the preceding paragraphs, space has forced us to omit many of the important details. But, the full report on frequency measurement devices is available to you for the asking. Just request on your company letterhead, "PRD Report Vol. 2 No. 2C".



Polytechnic Research and Development Co., Inc.

202 Tillary Street • Brooklyn 1, N. Y. • Tel: UL 2-6800
Cable Address: MICROWAVE, NEW YORK



PRD Precision Heterodyne Frequency Meter provides direct reading of any frequency from 100 to over 10,000 mc/s to an accuracy of <.03%!

This is the one unit that has all the features required for both laboratory measurements and production and field testing of transmitters and receivers. Completely self-contained and portable, the 504 Precision Heterodyne Frequency Meter gives you quick, simple operation with both CRT and aural presentation, and a new, exclusive direct interpolating dial. Consisting of a spiral scale fitted with an adjustable index, the dial permits direct interpolation to 0.1 mc/s at all settings. *No calibration charts needed* when you use the 504 Heterodyne Frequency Meter.

SPECIFICATIONS

Frequency Range: measures 100 to over 10,000 mc/s; generates 500 to 900 mc/s and harmonics
Calibrator Accuracy: 0.002% at 5 mc/s crystal check points
Interpolation: < 0.03% between 5 mc/s crystal check points
Resettability: < 0.02%
Input Sensitivity: at 500 mc/s and above—30 dbm; at 100 mc/s—5 dbm
Heterodyne Oscillator: 500-900 mc/s
Crystal Calibrator: Built-in 5 and 50 mc/s quartz crystal standards. The 5 mc/s crystal is temperature-controlled.
Power Requirement: 115/230V, 50-60 cps, single phase, 125 watts
Price: \$695 f.o.b. Brooklyn, N. Y.

For all the important details on PRD Heterodyne Frequency Meter, please request on your company letterhead, "PRD Technical Data Sheet 504C"

ENGINEERS: *Electronic & Mechanical* PHYSICISTS

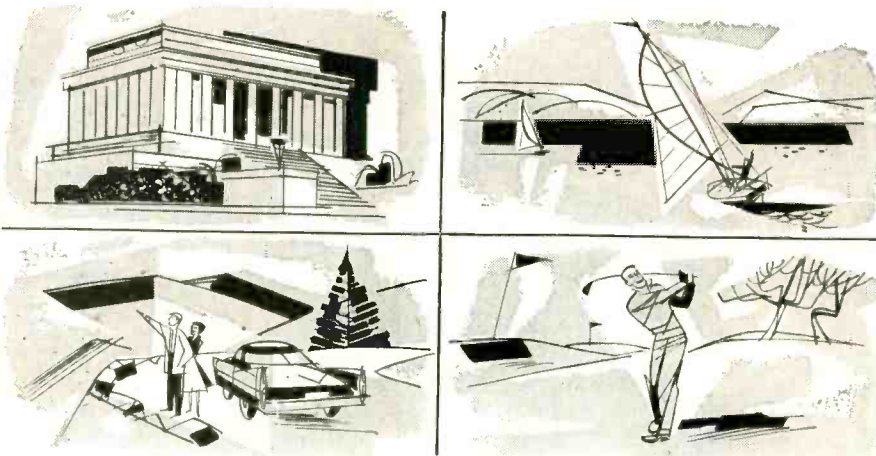

Finer climate & living... yours at MELPAR

Melpar is advantageously located in a residential suburb in Fairfax County, Virginia, 10 miles from Washington, D. C. Attractive new homes and apartments are within a few minutes traffic-free drive of our Laboratories. Modern shopping centers make trips to the city unnecessary except for enjoyment of its many cultural and recreational offerings.

Regardless of whether you choose suburban, country or city living, you'll enjoy our proximity to mountains, beaches, and other recreational and scenic attractions. Our climate is pleasant with its short winters, beautiful spring and fall seasons, and its average summer temperature of only 77°. Outdoor living is enjoyed 215 days of the year.

The Laboratory's "climate" is ideal, too. Our project group basis of organization enables you to participate in *complete* engineering problems and gain diversified experience. The range and complexity of our projects assure you of assignments which will stimulate your creative and analytical talents.

Qualified applicants may visit the area as our guests to inspect Melpar.

We Are Engaged In The Following Fields:

Flight Simulators. Radar and Countermeasures. Network Theory. Systems Evaluation. Microwave Techniques. Analog & Digital Computers. Magnetic Tape Handling. UHF, VHF, or SHF Receivers. Packaging Electronic Equipment. Pulse Circuitry. Microwave Filters. Servomechanisms. Subminiaturization. Electro-Mechanical Design. Small Mechanisms. Quality Control & Test Engineering. Field Engineering. Antenna Design.

For detailed information on Melpar and living in the Washington, D.C. area Write: TECHNICAL PERSONNEL REPRESENTATIVE



MELPAR, Incorporated

A Subsidiary of Westinghouse Air Brake Company

3008 Arlington Boulevard, Falls Church, Virginia
10 Miles from Washington, D. C.

Positions also available at our laboratories located in Watertown and Boston, Massachusetts.

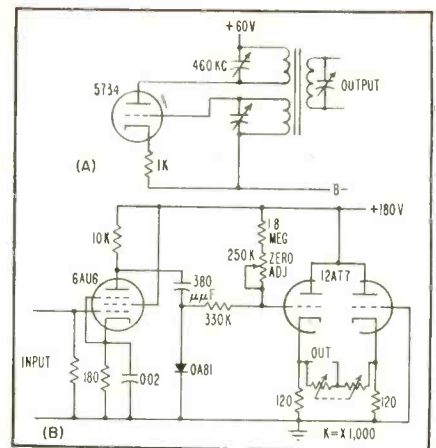

FIG. 2—Oscillator (A) and amplifier (B) used with blood pressure recorder

resistance, on the other hand, would cause nonlinearity.

Originally, direct-coupled amplifiers were used. In addition to the operating temperature problem, some difficulties were experienced in obtaining complete zero stability. Successful operation was finally obtained by having the transducer tube working as an oscillator. The oscillator circuit is shown in Fig. 2A.

Experiments with a number of different oscillating frequencies have shown that a frequency in

Voltage Multiplier

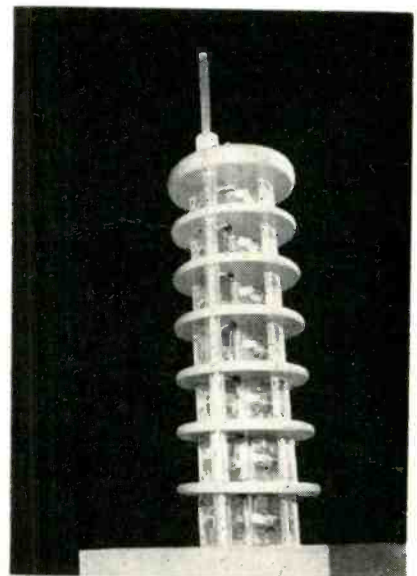

Used to simulate high voltage created on aircraft by clouds, which are composed of microscopic ice crystals, the leaning r-f type voltage multiplier built by Stanford Research Institute can attain as much as 200,000 volts

MULTI-PULSE SPECTRUM SELECTOR



140 mc input, also available for 160 mc

The Polarad Model SD-1 Spectrum Selector singles out a particular microwave pulse from a coded pulse chain so that it can be examined individually on a Spectrum Analyzer or Microwave Receiver.

Operation is simple. A pulse group is displayed on the CRT of the Selector. The pulse to be analyzed is intensified on the scope, and at the same time an automatic electronic gate allows only this pulse to pass through to the Spectrum Analyzer.

The Model SD-1 has been designed for use with Polarad Models TSA and LSA Spectrum Analyzers as well as microwave receivers within the frequency range of the instrument. Its operation does not affect the performance or restrict the frequency of the Spectrum Analyzer to which it is connected.

Write to Polarad or your nearest representative for complete information.

FEATURES:

- Makes possible the spectrum analysis of individual pulses in a pulse group.
- CRT display of a pulse group.
- Sweep expansion provided for inspection of closely grouped pulses.
- Pulse intensification to facilitate pulse selection.
- Automatic gating of spectrum analyzer, during the interval of pulse analysis.
- Continuously variable sweep width.
- Continuously variable gate width and gate position for pulse selection.
- Triggered sweep on first pulse in any pulse train.
- Provision for external sync and gate.
- Completely self-contained portable unit.

SPECIFICATIONS:

Gate Width
Continuously variable from 0.4 to 10 μ sec.

Gate Delay
For the Model SD-1
Continuously variable from 0.3 to 180 μ sec.
For the Model SD-1X
Continuously variable from 1 μ sec to 350 μ sec.

Maximum Pulse Train Time
For the Model SD-1180 μ sec.
For the Model SD-1X350 μ sec.

Minimum Pulse Rise Time.....0.05 μ sec.

Minimum Pulse Separation
0.5 microsecond between first and second pulses; 0.2 microsecond between any two following pulses.

Pulse Repetition Rate....10 to 10,000 pps.

Minimum Pulse Width.....0.1 μ sec.

R-f Input Frequency
160 mc input also available for 140 mc input

Permits spectrum analysis of individual microwave pulses in a pulse group in the fields of IFF, beacons, interference coding, radio telemetering and radar.



Model SD-1

For private demonstration without obligation ask for the



to stop at your plant

Reliable maintenance service throughout the country is an important part of the Polarad instrument.

POLARAD

PROVEN RELIABILITY

ELECTRONICS CORPORATION

43-20 34th Street, Long Island City 1, N. Y.

REPRESENTATIVES: Albany, Albuquerque, Atlanta, Baltimore, Boston, Chicago, Cleveland, Dayton, Denver, Englewood, Fort Worth, Kansas City, Los Angeles, New York, Philadelphia, Portland, Rochester, St. Louis, San Francisco, Schenectady, Stamford, Syracuse, Washington, D. C., Winston-Salem, Canada: Arnprior, Ontario. Resident Representatives in Principal Foreign Cities

0 CPS to 1 MC!
DIRECT READING



new
Computer-Measurements Model 226A

UNIVERSAL COUNTER-TIMER

OUTSTANDING FEATURES:

- ★ Three independent, adjustable trigger level controls permitting full raled sensitivity at any voltage level between -300 and +300 volts.
- ★ Small voltage increments ordinarily masked by attenuators are easily selected.
- ★ Simplified color-coded controls and direct read-out in kc, mc, sec, or millisecc, with automatic decimal point indication.
- ★ Oscilloscope marker signals facilitate start and stop trigger level adjustment for time interval measurement of complex waveforms.

A brand new, multi-purpose instrument provides precision measurement of frequency, frequency ratio, period (1/frequency), and time interval. Pressure, velocity, acceleration displacement, flow, RPS, RPM, etc. may also be measured with suitable transducers. The 226A may be used as a secondary frequency standard.

price: **\$1,100.00**

Long Term: 3 parts per million per week
 Display Time: Automatic: Continuously variable 0.1 to 10 seconds
 Manual: Until reset
 Input Impedance: 1 megohm and 50 mmf
 Trigger Level: Continuously adjustable from -300 to +300 volts
 Accuracy: ± 1 count ± stability
 Secondary Frequency Standard: 1 mc; 100, 10, 1 kc; 100, 10, and 1 cps
 Dimensions: 17" W x 8¾" H x 13½" D approx.
 Weight: 50 lbs. approx.

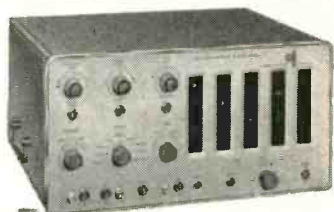

MODEL 225A 0 cps-100 kc
UNIVERSAL COUNTER-TIMER

Similar to the 226A in design. Featuring Oscilloscope Trigger Level Marker Signals; Three Direct-Coupled Inputs of 70 mv sensitivity; Direct Reading, Automatic Illuminated Decimal Point. Easily portable. Price: \$840.00

Data Subject to Change Without Notice - Prices F.O.B. Factory

Write for complete specifications on the new 226A and the 225A models and the complete CMC line of electronic counting and controlling equipment.

Computer-Measurements Corporation

5528 Vineland Avenue, North Hollywood, Calif. Dept. 78C

FREQUENCY

SPECIFICATIONS:

FREQUENCY MEASUREMENT

Frequency Range:
0-1,000,000 cycles per second
Input Sensitivity:
0.2 volt rms.
Direct-coupled input
Time Bases:
0.00001, 0.0001, 0.001, 0.01, 0.1, 1 and 10 seconds. Also can use external 0-1 mc standard

PERIOD MEASUREMENT

Period Range:
10 microseconds to 1,000,000 seconds
Frequency Range:
0.000001 cps to 100 kc
Input Sensitivity:
0.2 volts rms.
Direct-coupled input

Gate Times:
1 and 10 cycles of unknown frequency
Standard Frequency Counted:
1 mc; 100, 10, 1 kc; 100, 10, 1 cps; external 0-1 mc.

TIME INTERVAL MEASUREMENT

Range:
3 microseconds to 1,000,000 seconds
Start and Stop:
Two independent or common channels
Positive or negative slope
Input Sensitivity:
0.2 volts rms.
Direct-coupled input
Standard Frequency Counted:
1 mc; 100, 10, 1 kc; 100, 10, 1 cps; external 0-1 mc.

GENERAL

Stability:
Short Term: 1 part in 1,000,000 (temperature-regulated crystal)

the range from 400 to 500 kc is the most suitable. Used in this way, the transducer-tube anode voltage needed will be only about 60 v and the anode current is about 200 µa. Anode dissipation is too small to cause any serious rise in the operating temperature.

Using the amplifier shown in Fig. 2B, the oscillator output voltage is adjusted to about 2 v. A pressure change in the manometer from 0 to 300 mm of mercury will

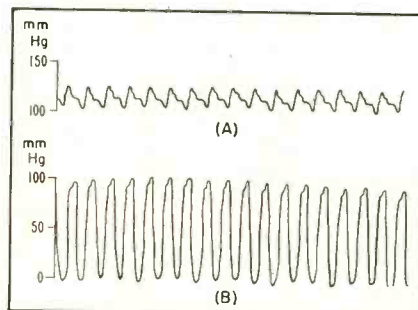

FIG. 3—Blood pressure recordings made in right carotid artery (A) and in left heart ventricle (B) of rabbit

cause a variation of the output alternating voltage of about 5 percent.

Typical blood pressure recordings from the heart of a rabbit are shown in Fig. 3.

This material was abstracted from a paper entitled Research on Mechano-Electronic Transducer Blood Pressure Manometers by Hjalmar Pettersson and Carl-Johan Clemedson at the 1956 ISA Conference.

Tester Checks Grid Emission

By E. A. BRAMSEN
 President
 Seco Mfg. Co.
 Minneapolis, Minn.

GRID EMISSION in vacuum tubes can cause unstable or improper operation of circuits. Tubes that check out on conventional tube testers as satisfactory may fail to operate properly owing to grid emission.

This phenomenon is most often encountered with high gain tubes such as the 6AK5. After the tube has reached operating temperature, the grid may emit electrons that

FREQUENCY • PERIOD • TIME INTERVAL • FREQUENCY • PERIOD • TIME INTERVAL • FREQUENCY • PERIOD • TIME INTERVAL • FREQUENCY

PERIOD • TIME INTERVAL • FREQUENCY • PERIOD • TIME INTERVAL • FREQUENCY



New Driver Chain for Pulsed High-Power Radar

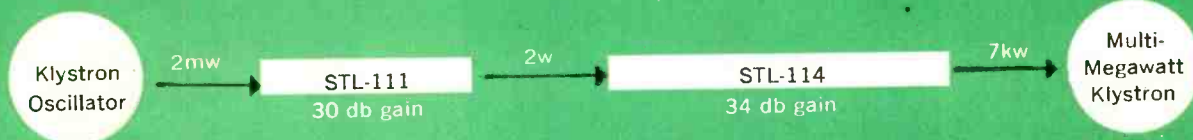

STL-111

STL-114

Sperry's New Metal Traveling Wave Amplifiers Cover 1100-1600 mc Range in L-Band

NOW IN PRODUCTION, these Sperry high-power traveling wave amplifiers bring new flexibility to pulsed high-power radar systems, and offer special advantages as wide-band repeaters and swept frequency amplifiers.

AS THE DRIVING POWER for multi-megawatt klystrons, the STL-111 and STL-114 feature a high duty cycle and fast—even instantaneous—frequency change *with no need for tuning or voltage modification*. In cascade they amplify a signal from 2 mw to 7 kw, with a gain of over 60 db.

RESISTANCE to thermal and mechanical shock is extremely high, due to sturdy metal envelope and ceramic rods supporting the helix. RF connectors are integral parts of the tube structure.

Write our Electronic Tube Division for data sheets on these new amplifiers (as well as other driver chains in other high frequencies).

CHARACTERISTICS: STL-111 STL-114

Frequency Range1100-1600 mc	1100-1600 mc
Saturation Power Output4w7kw
Gain at Saturation Power	..30 db34 db
Small Signal Gain36 db40 db
Beam Voltage900 v14 kv
Duty CycleContinuous005
Magnetic Field450 gauss700 gauss

ELECTRONIC TUBE DIVISION
SPERRY GYROSCOPE COMPANY
Great Neck, New York
DIVISION OF SPERRY RAND CORPORATION

CLEVELAND • NEW ORLEANS • BROOKLYN • LOS ANGELES • SAN FRANCISCO • SEATTLE
IN CANADA: SPERRY GYROSCOPE COMPANY OF CANADA, LIMITED, MONTREAL, QUEBEC

VISIT SPERRY AT THE RADIO ENGINEERING SHOW, NEW YORK COLISEUM, MARCH 18-21, BOOTHS 1416-1422

*Gives you direct
capacitance reading
from 0.01 μf to 12 μf*

**BALLANTINE
CAPACITANCE
METER
Model 520**



The Model 520 Capacitance Meter is a general laboratory instrument which measures capacitance over the wide range found in paper, plastic, mica, ceramic and air type capacitors. The value of unknown capacitance is read directly from the meter scale by manipulating only one control knob. The ability to measure direct capacitance, excluding strays, makes it very useful for low value measurements. Adjustable limit pointers, together with fast operation, make it valuable for incoming inspection departments. The instrument has a built-in calibration standard.

SPECIFICATIONS

RANGE: 0.01 μf to 12 μf FREQUENCY: 1,000 cps
 ACCURACY: 2%, 0.1 μf to 12 μf ; METER: Logarithmic scale
 5%, 0.01 μf to 0.1 μf SIZE: 13½" x 7½" x 7"

BALLANTINE LABORATORIES, INC.



100 FANNY ROAD, BOONTON, NEW JERSEY

will permit the flow of grid current in a reverse direction. Where biasing circuits are fed through a common bus, grid emission in one tube may change the value of bias on other tubes.

Effective tube life and equipment availability has been increased by checking tubes for grid emission. It was also found that 90 percent of the tubes that had grid emission could not be checked on a trans-



Checker finds grid-emission defects that do not show up under conventional tube tests

conductance-type tester. Gas tests provided on most tube testers do not have sufficient sensitivity.

One method for checking grid emission uses a capacitor charged by the reverse grid current. By measuring the time required for the voltage across the capacitor to reach a steady state, the grid current can be computed as

$$\Delta e = \frac{e}{RC} (dt), i = CR \frac{\Delta e}{\Delta t}$$

When a 1 μf capacitor and a 1-megohm resistor are used,

$$i = \left(\frac{\Delta e}{\Delta t} \right)$$

A tube tester developed for laboratory and field use checks control-grid emission in addition to checking for grid-to-cathode shorts, gaseous conditions and cathode-to-heater shorts.

The tester is provided with eight tube sockets, a zero-adjust knob and a filament voltage selector switch. To check a tube, the filament voltage selector switch is set to the right value and the zero-adjust control is set so that the

NEW ...

General Electric Double-diode

*Vac-U-Sel** Rectifier

Cuts Costs as Much as 35%

THIS REPLACES THIS

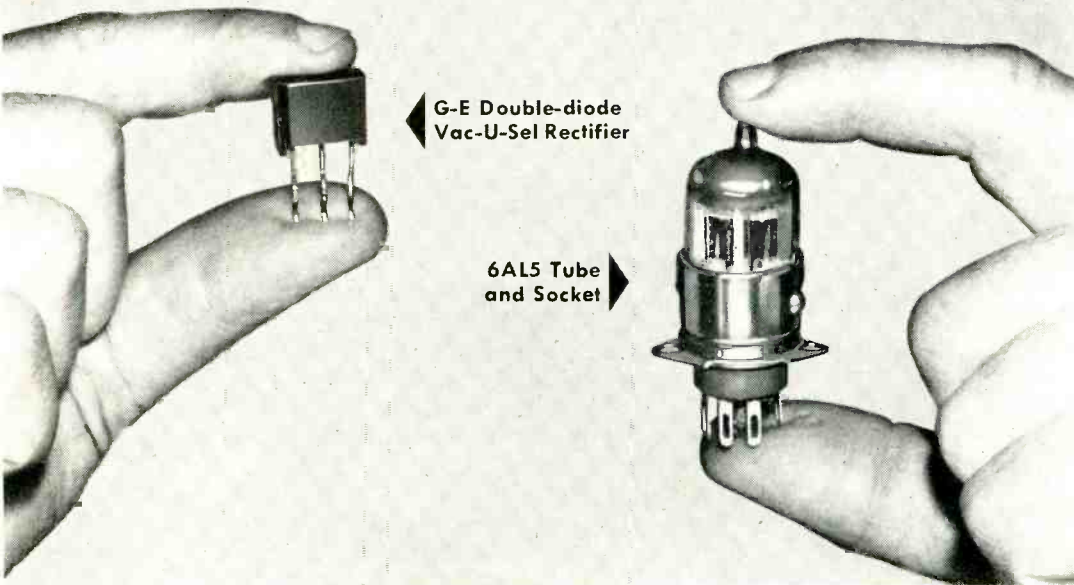

With a few minor modifications in most basic circuits General Electric's new double-diode Vac-U-Sel rectifier can replace the heavier, larger, 6AL5 tube and socket. Cost of the new Vac-U-Sel rectifier to you may be only about 65% that of a tube and socket.

Although designed for a wide range of uses, the new General Electric Vac-U-Sel double-diode rectifier is ideally suited for use as a TV horizontal-phase-detector diode. Other outstanding features include:

- longer life
- breakage-resistant
- low cell capacitance
- no filament power required

Sealed firmly in a durable, moisture-resistant housing the new General Electric Vac-U-Sel selenium rectifier is designed to be automatically assembled by machine. Longer leads are available for hand assembly in conventional chassis. Units consist of two single cells which may be either common cathode or plate-to-cathode connected.

SEE THIS GENERAL ELECTRIC VAC-U-SEL DOUBLE-DIODE RECTIFIER . . . INSTALL IT . . . OBSERVE FIRST HAND ITS HIGH PERFORMANCE . . . WRITE TODAY FOR A FREE PRODUCT SAMPLE.

*Reg. trade-mark of the General Electric Co.

Progress Is Our Most Important Product

GENERAL ELECTRIC

FREE RECTIFIER

for trial installation

To:
General Electric Company
Section A461-45
Schenectady 5, N. Y.

Gentlemen:

Please send me free of charge one new General Electric Vac-U-Sel double-diode rectifier.

NAME _____

COMPANY _____

ADDRESS _____

CITY _____ STATE _____

POSSIBILITIES UNLIMITED

bring yourself
up-to-date on

INDIUM

... and what it
can do for you

ORBITS
O-3
N-18
M-18
L-18
K-8
2

49 $2P_{\frac{1}{2}}$
indium $r^l=2^1, 4$

In $5s^2 5p^1$

114.76 $\times 3$

117-116-115-114-113-112-111-110

QUALITY

at the Indium Corp. of America means: purity of metals, and strict adherence to specifications.

SERVICE

means prompt delivery to customers, and technical help in specific uses of Indium.

RESEARCH

means "forward looking" with respect to new products and techniques.

WRITE TODAY

for new Indium bulletin... "Nomographic Charts of Pellets and Spheres - Weights per Thousand in Grams."

The **INDIUM** Corporation of America

1676 Lincoln Avenue

Utica, New York

SINCE 1934... PIONEERS IN THE DEVELOPMENT AND APPLICATIONS OF INDIUM FOR INDUSTRY

INDIUM... the metal of unlimited possibilities... is the "element of success" in many startling engineering achievements.

Its unique stabilization properties have made possible revolutionary metallurgical advances in the electronics and aircraft fields.

INDIUM may have significant applications in your own product development!

Why not discuss your problems with us?

AVAILABLE IN COMMERCIAL QUANTITIES

- Indium metal (specially refined 99.999% pure)
- Indium metal (99.97+ % pure)
- Indium wire • Indium foil and ribbon
- Intermediate "indalloy" solders
- Indium pellets • Indium spheres • Indium powders

Rapid Missile Tester

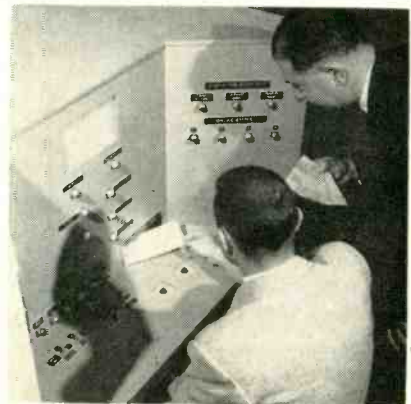

Automation of missile testing in tactical combat areas is possible with RACE (Rapid Automatic Checkout Equipment) produced by Sperry Gyroscope. If a faulty component is detected, its location and replacement time is flashed on the console screen (top left) and a punch card spotting the plug-in replacement for technicians is delivered (below)

tester's electronic eye indicator just closes. The tube is then plugged into the appropriate socket. If the eye opens beyond the indicated limits, after a warm-up period, the tube is defective. By doubling the filament voltage for a few seconds and then testing at rated filament voltage, borderline tubes will show up as defective.

The instrument contains a simple d-c amplifier circuit with an elec-

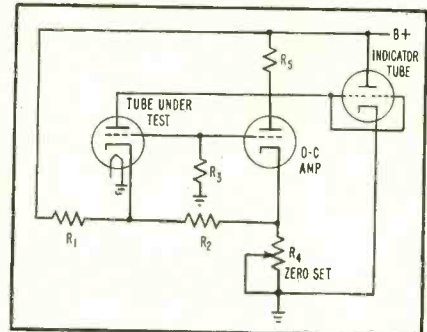
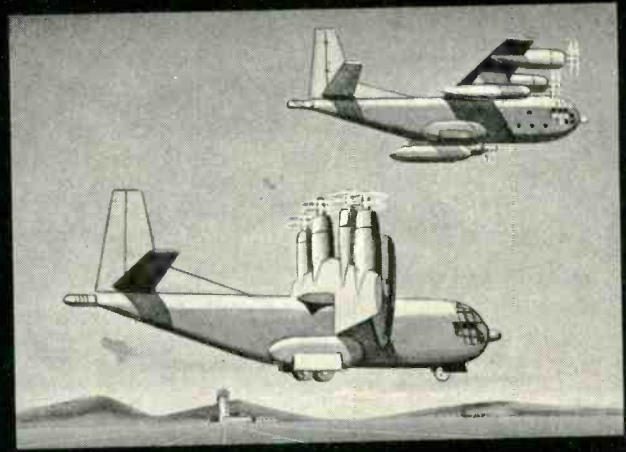

FIG. 1—Simple circuit uses electron-eye tube to check grid emission

tronic-eye tube as an indicator. The circuit is shown in Fig. 1. Resistors R_1 , R_2 and R_4 form a voltage divider network that biases the tube under test to cutoff or beyond cutoff. Potentiometer R_4 is adjusted so that the eye tube is closed. At this setting the d-c amplifier is biased

tomorrow is here today!

Rising like a 'copter, this tilt-wing transport will cruise at 350 m.p.h. Originally thought of as an impossibility, this unusual plane is in the design stage today. The versatility of flight direction is accomplished by tilting the wings 90 degrees for vertical takeoffs and landings. Tilting with the wing are four six-blade, contrarotating propellers and their high powered turboprop engines. Today's airports with their extensive runways may soon be facing obsolescence.



Z821A

CUSTOM MODULATORS from STANDARD DESIGNS

FXR High-Power Pulse Modulators are custom-built to meet the specific requirements of each application through the use of FXR standard designs, developed by our skilled modulator engineering group. Our staff of experienced application engineers cannot be surpassed in the close integration of the most recent engineering developments with packaged design and standard procedures. You benefit, with a precision instrument of economical cost.

FXR's competent and efficient research, design and development staff, augmented by ultra-modern manufacturing facilities capable of production-quantity fabrication welcomes the opportunity to aid you in the design and construction of the most intricate pulse modulators and high-voltage power supplies.

Send for the "Preliminary Questionnaire" to assist you in planning the design of your next High-Power Pulse Modulator!

High Power Modulator Type No.	Power (peak megawatts)	Voltage (peak kilovolts)	Current (peak plate-amperes)	Impedance (output-ohms)	Duty Cycle (maximum)	Pulse Shape (µsec/pps)	Input 60 CPS (∅/volts)	Size (HxWxD, ft.)	Weight (lbs.)	Tubes Operated
Z820A	1.0	33	33	1,000	.001	0.5/2000 2.5/400	1/190-250	6x2x3	1400	4J50, QK-349 RK-6249
Z821A	14.0	90	160	560	.001	2.0/200-500	3/440-550	7x4x7	6800	QK-338
Z822A	0.2	20	10	3,330	.018	10/1200-1800	3/440	6x3x4	3330	SAL 39 (GL-6625)
Z823A	0.042	12.7	3.3	3,330	.064	coded/300	3/440	6x4x4	3200	SAL 39
Z824A	0.625	25	25	1,000	.001 at 0.5/2000	1.0/1000 2.0/250 5.0/100	1/190-250	6x2x3	2500	QK-349 at reduced power
Z825A	1.6	40	40	1,000	.001 at 0.5/2000	1.0/1000 2.5/400	1/190-250	6x2x3	2500	WE-5780

Modulator Loads and Exhaust Ovens are also available.

See us at the
IRE Show
BOOTH 3715, 3717



Electronics & X-Ray Division

F-R MACHINE WORKS, Inc.

26-12 Borough Place, Woodside 77, N. Y.

ASTORIA 8-2800



Write TODAY for new catalog of complete line of Precision Microwave Test Equipment.

Representatives: Los Angeles: J. C. VanGroos Co.; Denver: Hytronic Measurements Inc.; Chicago: KaDell Sales Assoc.; Export: Szucs Int'l Co., N. Y.

to cutoff and no current flows through R_5 .

If reverse grid current flows in the tube under test owing to grid emission or other cause, the input of the d-c amplifier becomes less negative causing the d-c amplifier tube to conduct and produce eye-tube deflection. Any appreciable leakage between the cathode and heater of the tube under test will also lower its bias as well as the bias on the amplifier, resulting in eye-tube deflection. Gas and grid-to-cathode shorts will also actuate the amplifier.

A spare tube socket on the front panel is used for preheating tubes.

To prevent damage to tubes under test, grid-to-cathode potential difference is limited to 45 volts.

Effects of Radiation

TESTS of electronic components under reactor radiation indicate that most components will function under extended irradiation. Exceptions are phototubes, germanium and copper-oxide rectifiers, resistance-wire strain gages and some types of resistors and capacitors. Presence of boron, ionizable gases or definite crystal structure make components likely to fail.

In most of the tests, components

Radiation Whiskers

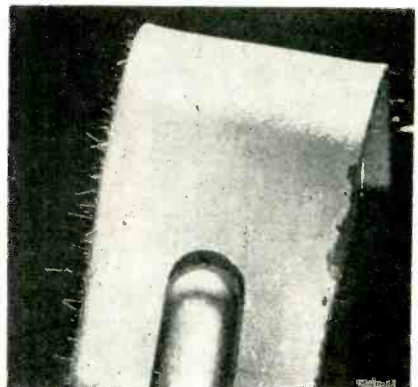

The phenomenon whereby growth of hair-like metallic whiskers occurs on certain metals has recently been enhanced by exposure to atomic radiation. Samples of tin placed in the Brookhaven reactor for a month and allowed to stand for a year exhibit greater whisker growth, probably resulting from damage to crystal structure by neutron bombardment

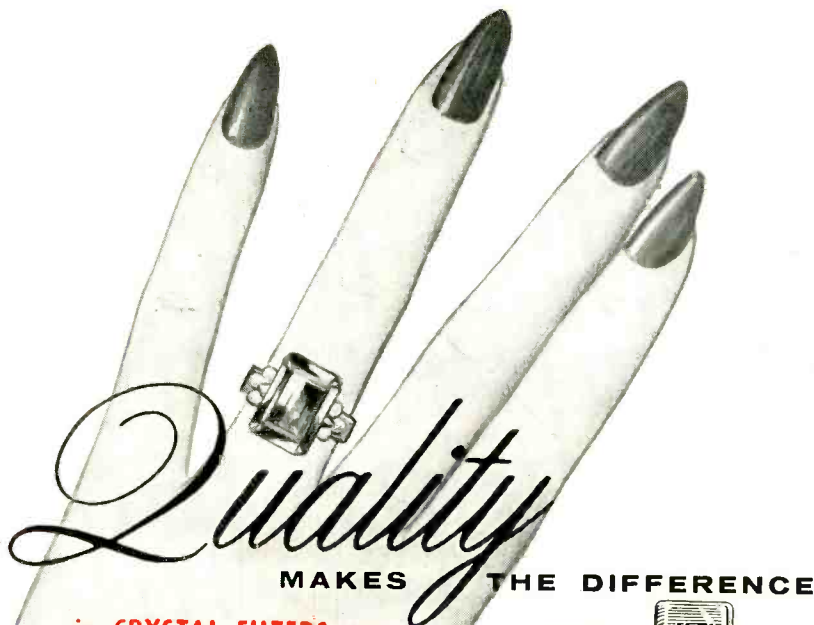

...in CRYSTAL FILTERS, too.

For the very latest
developments
in crystals and crystal filters
see us at Booth 2311
1957 Radio Engineering Show
The Coliseum New York City

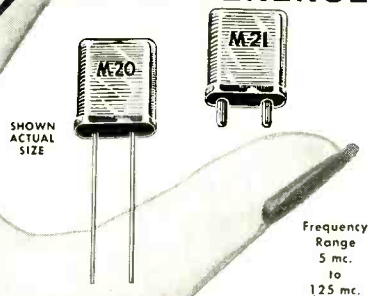

You can't see it . . . feel it or weigh it. Only by observing their unexcelled performance can you appreciate the assurance of super dependability that regular users of McCoy crystals have come to take for granted. Discover it for yourself. Next time you order crystals—insist that they be . . .

. . . the real McCoy

Frequency
Range
500 kc.
to
125 mc.



SHOWN
ACTUAL
SIZE

McCoy ELECTRONICS COMPANY

MT. HOLLY SPRINGS, PA.

DEPT. E-3

Phone 376 and 377

FENWAL'S THERMOSTATS NOW CIGARETTE SIZE

Some Units Smaller Still

Take Little More Room Than Sugar Lump

ASHLAND, MASS. — If you want to control temperatures in tight spots, you should see Fenwal. Fenwal has cut the size of thermostats way down.

You can fit one of their Midget THERMOSWITCH units anywhere a cigarette will fit. And, if you're working with even less space, one of their Miniature THERMOSWITCH units is what you're looking for. The Miniatures are little bigger than a lump of sugar, and some are even smaller.

The Midgets and Miniatures use the same unique principle used in Fenwal's bigger THERMOSWITCH controls. They use it with the same high degree of success.

The principle of all Differential Expansion THERMOSWITCH units, large or small, is this: a single metal shell expands or contracts with temperature changes, making or breaking totally enclosed electrical contacts.

The smallness of the Midget and Miniature units does not deprive them of any of the performance characteristics that have made larger THERMOSWITCH units famous. They have THERMOSWITCH ruggedness, THERMOSWITCH accuracy, and reasonable THERMOSWITCH prices.

Temperature range of the Midget series: -50°F to 500°F . Range of the still smaller Miniature series: -20°F to 275°F .

Midgets and Miniatures, all in stainless steel, come in a variety of mountings. Hermetic sealing is also available.

These Fenwal THERMOSWITCH units are precision-engineered to give optimum temperature control with minimum-sized devices. They remain

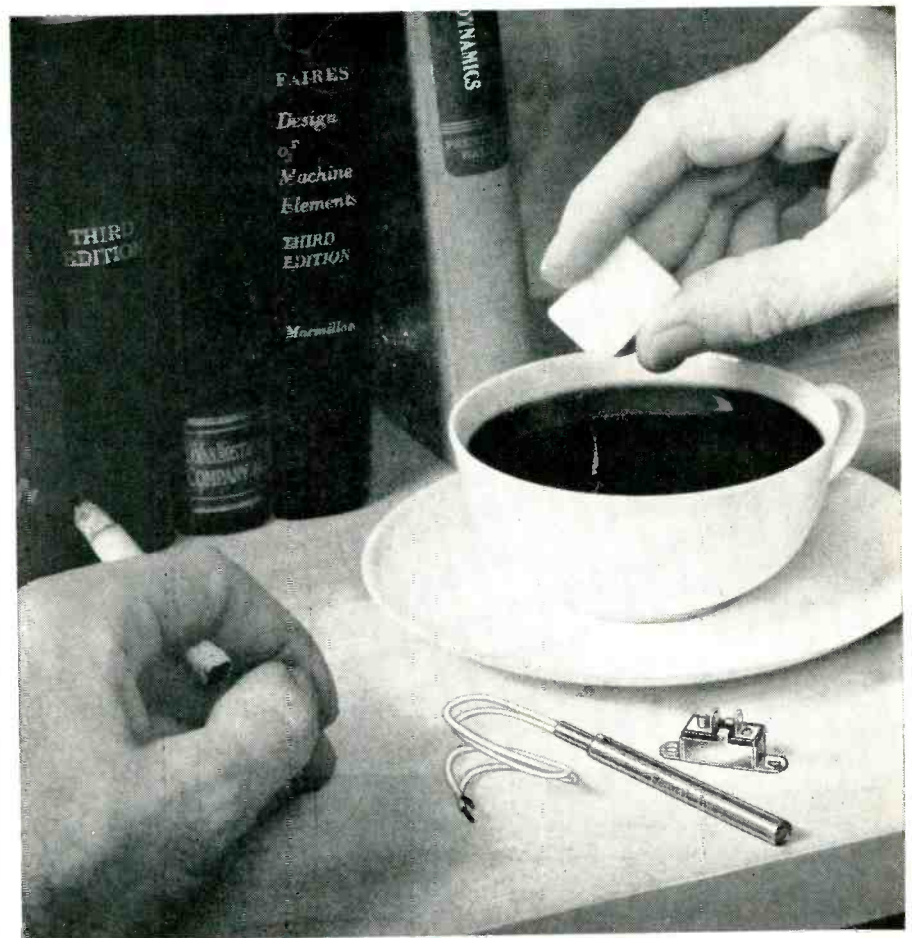

THERMOSTATS FOR TIGHT SPOTS — A Fenwal Midget THERMOSWITCH® unit and a Fenwal Miniature THERMOSWITCH unit — two good answers to the question, "How can you install an accurate, reliable thermostat where there's almost no room?" Actual sizes of these particular models — $\frac{1}{4}$ " x $2\frac{25}{32}$ " for the Midget; 1 " x $\frac{1}{2}$ " for the Miniature.

accurate under the most severe operating conditions.

You should have details on this advance in temperature control at your fingertips. Write for information to **Fenwal Incorporated, 203 Pleasant Street, Ashland, Massachusetts.**

Fenwal

**CONTROLS TEMPERATURE
...PRECISELY**

Ah! perfection!



COAXIAL COUPLER

Models 3000-10 through 3003-30
covering 225 to 4000 mc.

Flat coupling over full octave range. Complete power measurement over most widely used microwave frequency ranges with only four models. 20 db minimum directivity provided over frequency range for each Coaxial Coupler. Coupling values of 10 db, 20 db, and 30 db available.



COAXIAL HIGH POWER TERMINATIONS

Models 369F and 369M

For more accurate VSWR measurement of all types of coaxial components. The new models are useful over the complete frequency range from 700 to 12,400 mc. with VSWR 1.20 or less. Maximum VSWR is 1.10 from 1,000 to 9,000 mc. The terminations are designed for power levels up to 200 watts average and 50,000 watts peak. Made from an entirely new termination material developed by Narda engineers.

COMPLETE LINE OF COAXIAL AND WAVEGUIDE INSTRUMENTS INCLUDES:

DIRECTIONAL COUPLERS	SLOTTED LINES
TERMINATIONS	DETECTOR MOUNTS
FREQUENCY METERS	ATTENUATORS
HORNS	STANDARD REFLECTIONS
TUNERS	BOLOMETERS
ECHO BOXES	THERMISTORS

FREE ILLUSTRATED CATALOG

contains much valuable data



were connected in circuits typical of their usual functions and data were taken during irradiation.

As a detailed test of circuit operation a composite multiplier-phototube assembly excited by an argon lamp was operated during irradiation. The argon exciter lamp required increased d-c bias for operation under irradiation. The phototube gave a reduced signal. This was probably caused by an increase in dark current under irradiation.

► **Results**—Except for exciter lamp and phototube, no changes were observed in 145 equivalent hours of irradiation. Signal modulation, output, temperature and all power-supply voltages were observed in addition to the bias voltage of the argon lamp.

Five tubes (6AG7, 6SN7, 6B4G, 6L6 and 6L6G) showed no changes in their dynamic characteristics. More extensive tests with five others for controls showed no radiation effects on either gas pressure or plate resistance. The same type of test was performed on types 6SJ7 and 6H6 with similar results. No effect was observed in either extinction or ignition voltages of irradiated VR75's

Irradiated Polyethylene



First commercial product of GE research in electron radiation, Irrathene irradiated polyethylene tape is used here to wrap coils for Sonotone's sintered-plate, nickel-cadmium batteries. Conventional polyethylene is bombarded with high-velocity electrons to give it improved high temperature qualities (ELECTRONICS, p 146, May 1956)



the **narda**
corporation

160 HERRICKS ROAD, MINEOLA, N. Y. • PIONEER 6-4650

COMPLETE INSTRUMENTATION FOR MICROWAVE AND UHF

WHERE ELECTRONICS MEETS THE EYE

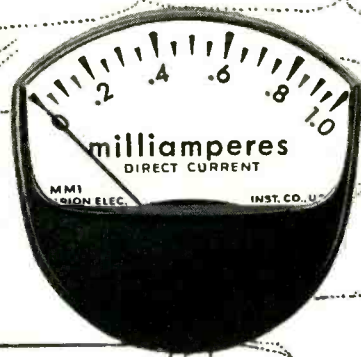

marion
MEDALIST
meters

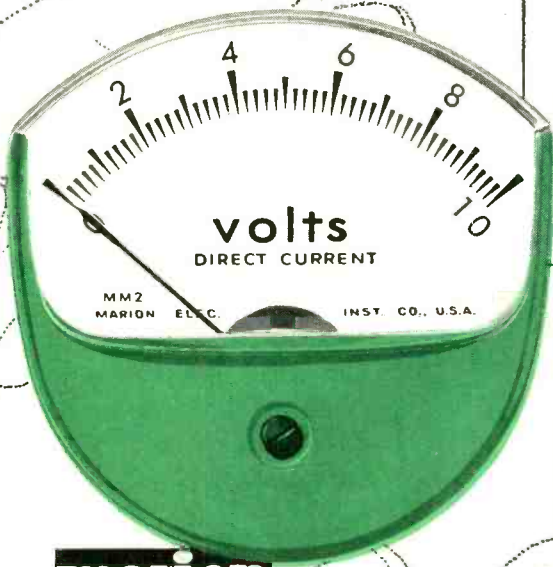

marion
advancement
in instrument
design

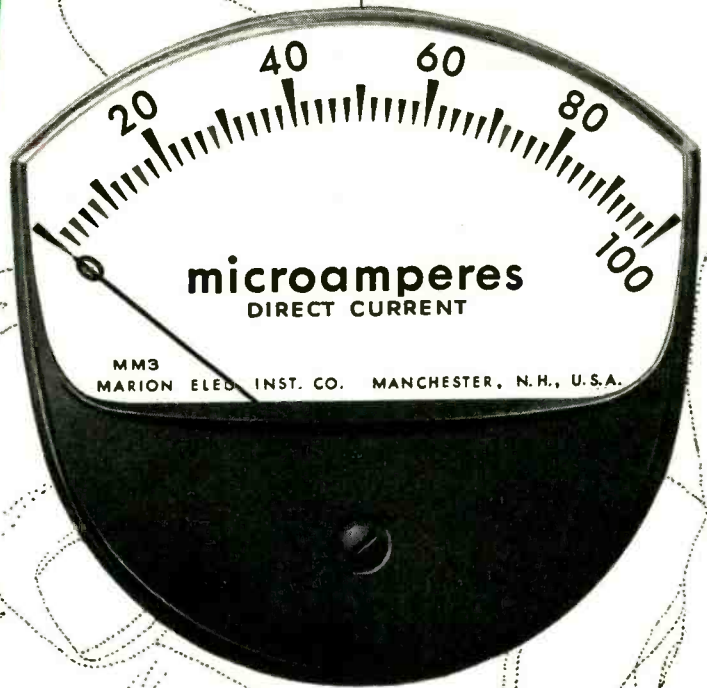

Three things set Medalists apart from other panel instruments: style, color and readability.

Their distinctive shape enhances whatever equipment they become a part of; standard or custom-matched case and dial colors further improve equipment appearance.

Longer scale length, larger numerals and better over-all dial illumination vastly increase their readability.

Medalists are made in all standard ranges, in 1½", 2½", and 3½" sizes. They provide a functional beauty that is unique among panel instruments today.

marion electrical instrument company
GRENIER FIELD, MANCHESTER, NEW HAMPSHIRE

At the I R. E. Show, March 18-21:
Booth 2126

Copyright © 1957, Marion

American Beauty

ELECTRIC SOLDERING IRONS

**MILLIONS OF
MINUTE
CONNECTIONS**

**ANY SIZE-
ANY STYLE-
ONE QUALITY
the BEST!**

Today's complicated electronic and aircraft electrical circuits demand soldering equipment specially designed to make these countless tiny connections . . . accurately, dependably and quickly • American Beauty has a model and tip size to meet practically any specialized requirement. Highest quality tools that give top performance month after month in toughest production use • Send us your soldering problems . . . our years of specialized experience are at your service.

AMERICAN ELECTRICAL HEATER COMPANY

American Beauty
ELECTRIC IRONS
SINCE
1894

161-H

DETROIT 2, MICHIGAN

argon and neon glow tubes.

► **Ballast**—Tests on ballast tubes and gage tubes especially designed to measure performance of platinum and tungsten filaments showed that neither was affected by radiation.

Tests indicate that capacitors containing boron should not be used in nuclear radiation fields. Other types displayed satisfactory performance, in general, although some decreased in capacitance value.

With the exception of one type, resistors showed only small radiation effects. Wire-wound types are among the most stable of resistors tested.

Fission-produced radiation has negligible effect on thermal and current-induced noise in resistors. This conclusion comes from two hours of measurements with both carbon and wire-wound resistors in a flux of 10^{11} n per sq cm per sec.

Different types of dry rectifiers behave differently in radiation fields. Particularly stable in high fluxes are silicon types 1N21 and 1N23 and the selenium type 403-D2625.

► **Piezo Devices**—Quartz crystals were used in oscillators that operated in the reactor for 46 days with no changes in frequency.

Strong radiation fields cause some deterioration in all dry cell

Two Megawatt Klystron



Smallest and largest klystrons produced by Litton Industries at San Carlos, Calif. are described by vice-president Norman H. Moore to guest at recent West Coast open house

Available now...

HR10211
HR10212
HR10213
HR10214
HR10215
HR10251
HR10252
HR10253
HR10254
HR10255

HUGHES SILICON RECTIFIERS

Hughes introduces a new series of high-quality silicon rectifiers, especially designed for use in miniaturized circuitry. These new low-power rectifiers are characterized by low forward voltage drop, together with low back leakage. They are exceptionally efficient units in electronic power supplies and, in such applications, can be used in place of many conventional vacuum tubes.

The new Hughes Rectifiers feature: maximum AC input voltages up to 275 volts RMS; maximum reverse DC working voltages up to 375 volts; maximum average rectified forward current up to 200mA; maximum power dissipation (at 25°C) up to 200mW. Operating temperature range for all types: -75°C to +150°C.

PHYSICAL CHARACTERISTICS

All Hughes Rectifiers are packaged in a one-piece, fusion-sealed glass body. This famous construction is impervious to moisture penetration, ensures stable operation under severe operating conditions. Maximum dimensions, rectifier glass body: length, 0.265-inch; diameter, 0.105-inch.

Our sales engineers will welcome the opportunity to discuss applications of these new rectifiers with you. For the address of our sales office nearest you, or for more complete specifications concerning the new Hughes Rectifiers, visit Booths 2801, 2803, 2805 at the I.R.E. Show, or write:

SEMICONDUCTOR DIVISION • HUGHES PRODUCTS
International Airport Station, Los Angeles 45, California

HUGHES PRODUCTS

© 1957, HUGHES AIRCRAFT COMPANY

HUGHES



SEMICONDUCTORS

A resilient insert rack and panel connector



Here is the new and improved Bendix Type SR rack and panel electrical connector with outstanding resistance to vibration. The low engagement force of this connector gives it a decided advantage over existing connectors of this type.

Pressurization is easily accomplished. The resilient inserts press firmly against the shell wall holding the contacts in exact position. Insert patterns are available to mate with existing equipment in the field.

Adding to the efficiency of this rack and panel connector is the performance-proven Bendix "clip-type" closed entry socket.

Here, indeed, is another outstanding Bendix product that should be your first choice in rack and panel connectors.



SCINTILLA DIVISION of Bendix
SIDNEY, NEW YORK

Export Sales and Service:
Bendix International Division, 205 East 42nd St., New York 17, N. Y.

FACTORY BRANCH OFFICES:
117 E. Providencia Ave., Burbank, Calif. • Paterson Building, 18038 Mack Ave.,
Detroit 24, Mich. • 545 Cedar Lane, Teaneck, N. J. • 5906 North Port Washington Rd.,
Milwaukee 17, Wisc. • Hulman Building, 120 W. Second St., Dayton 2, Ohio • 2608
Inwood Road, Dallas 19, Texas • Boeing Field, Seattle 8, Washington • 1701 "K"
Street, N.W., Washington 6, D. C.

Want more information? Use post card on last page.

batteries. In general-purpose applications this would cause only a slightly shortened useful life. However, the single type of bias cell tested showed such changes of terminal voltage as to be unusable in strong fields.

In three experiments flashlight and hearing-aid type batteries were divided into four groups: test on open circuit, test under load, control on open circuit and control under load. Daily readings of terminal voltages were made with 100 and 10,000-ohm loads.

In the bias-cell experiment, heat caused no appreciable change in the voltage of test cells but radiation caused unreliability.

► **Strain Gages**—Also unreliable were resistance-wire strain gages. These were strained by energizing relays to which they were bonded for testing. Differences between strained and unstrained output voltages were used as the gage readings. The results showed that radiation has a significant effect.

This material was abstracted from an article "What are Effects of Radiation on Electronic Components" appearing in *Nucleonics*, p 33, July 1956.

Iron Dust Magnet



Ordinary iron in the form of submicroscopic elongated particles has been used by GE engineers to make magnets equal in strength to available commercial types. Unit shown has wire coil soldered to one end. Other end is tapped

BEGIN YOUR
RADIO
ENGINEERING
YEAR

**WITH MORE THAN
800 NEW IDEAS!**

No wonder engineers say the radio-electronics year begins in March! This year, the manufacturers and suppliers for this 12 billion dollar and still growing industry require all 4 floors of New York City's Coliseum to show you their new ideas.

834 exhibitors representing more than 80% of the industry's productive capacity will display all that's new in equipment, component parts, instruments and production at *The Radio Engineering Show*. Attending the Show gives you an opportunity to talk with the men responsible for these newest advances in radio-electronics. The 55 technical sessions of *The IRE National Convention*, with over 200 new papers presented by 22 different professional groups, will also inform you of up-to-the-minute developments in your specialized field of electronics.

Begin the year right. See and hear all that's new in 1957 radio-electronics. Plan to attend or, better still, make your reservations today!

REGISTRATION: IRE Members \$1.00
Non-members \$3.00

MARCH 18-21

The **IRE**
National Convention
Waldorf-Astoria Hotel
and The Radio Engineering Show
Coliseum
New York City



1st floor: EQUIPMENT
2nd floor: COMPONENT PARTS
3rd floor: INSTRUMENTS &
COMPONENTS
4th floor: PRODUCTION &
3 lecture halls

The
Institute of
Radio
Engineers



1 East 79th Street, New York 21, N. Y.

Pecan-Shell Blast Removes Enamel From Coils on Conveyor



Behind strong glass, four blasts of cracked shells knock enamel off fine wire on one side of flat coil in each recess of conveyor belt

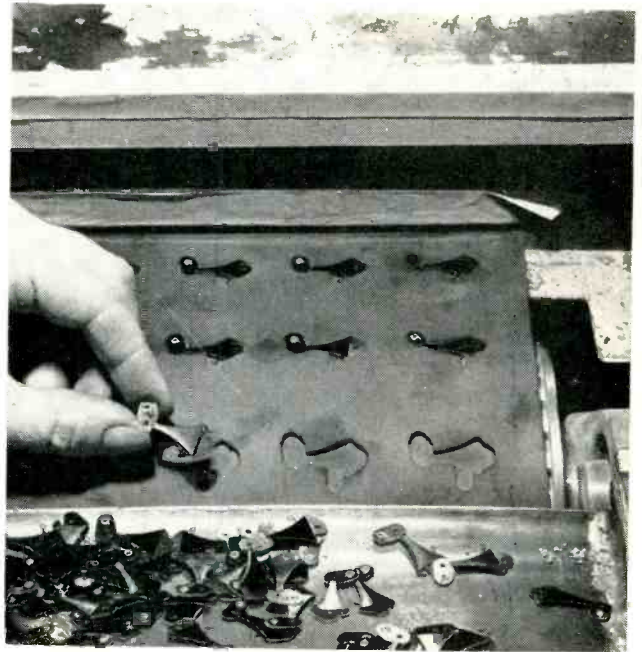

Method of loading coil on belt. Coil serves as compensating heater for thermostat in electronic temperature-control system

TO REMOVE ENAMEL from hair-thin wires used in shaped flat nonlinear coils, Minneapolis-Honeywell bombards the coils with finely ground pecan shells and apricot pits. The flying grit does the job at a fraction of the cost of chemicals or other more conventional burnishing methods. For still more sensitive wire coils, powdered corn cobs are used as the abrasive in the machine.

Production of the elements now

runs at a rate of 1,000 an hour. The best previous rate, by routine enamel-removing operations, was 1,000 a day.

The operator loads the coils into four rows of masking slots on an endless conveyor belt that travels through the cleaning chamber. Inside, each row of coils passes under one of the four shell-blast nozzles, for removal of enamel on the side over which a wiping contact arm is to travel. Cleaned coils travel

out the rear of the chamber and drop into a container as the belt comes down over its rear roller.

The shell particles fly around inside the cleaning chamber and eventually drop off the sides of the belt into a hopper below. Shells can be used over again if screened occasionally to remove pieces that have broken up during use. Shells are loaded into an overhead hopper, from which they enter the air blasts of the individual nozzles.

New Materials Cut Drafting Costs for Printed Circuits

By N. J. SCHUSTER

*Electronics Development Department
Lockheed Aircraft Corp.
Research Branch
Missile Systems Division
Van Nuys, California*

THE CHANGING NATURE of data requirements in a missile testing program made it necessary to seek an improved procedure for preparing reproducible copy for printed circuits and to find a method of eliminating costly and time-consuming art revisions. After experimenting

with various techniques, it was found that B-150 pressure-sensitive self-sealing black tape manufactured by W. H. Brady Co., Milwaukee, Wisc. and Stabilene plastic film manufactured by Keuffel and Esser Co. could be substituted for the usual India ink and opaque illustration board. The use of these new tools permitted a lower degree of skill, saved a skilled draftman's time for other tasks, eliminated the dimensional instability inherent in

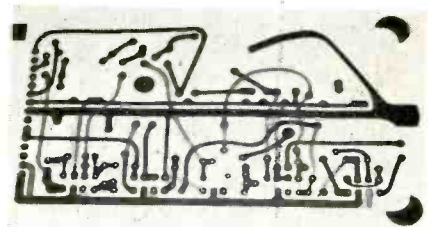

Checking master copy registration. Two-sided circuit is aligned back-to-back, greatly simplifying art changes. All wiring lines are made with easily changed pressure-sensitive tape. Curves are inked in on other side of film



THERE'S NO SUBSTITUTE FOR EXPERIENCE..

YESTERDAY - TODAY - TOMORROW

JUST ONE QUALITY...THE FINEST!

KESTER SOLDER

INDUSTRY-TESTED AND PROVED FOR OVER 50 YEARS...

You hear a lot about the remarkable showing of "Johnny-come-lately" solders from that second source of supply, based only upon test samples or short production runs. But there's no real substitute for regular on-the-job applications to prove the actual merits of a product like solder. That's why Kester Solder is the preferred choice of wise solder buyers and users everywhere; they know it has over half a century of genuine experience and unqualified production approval behind every spool.

Write today for complete details.

**YOUR COPY FREE! Kester's 78-page manual
"SOLDER . . . ITS FUNDAMENTALS AND USAGE." Send today.**

KESTER SOLDER COMPANY

4204 Wrightwood Avenue, Chicago 39, Illinois

Newark 5, New Jersey, Brantford, Canada

art board and resulted in more accurate registration of a two-sided circuit. Total time for preparing original art masters was cut approximately in half.

► **Drafting Technique**—The printed-circuit pattern is first roughed out on vellum, enlarged two or four times if the circuit is very small. The plastic film is placed over the pattern, matte side up, and the circuit is taped on the plastic film using the appropriate pressure-sensitive circles and lines. The drawing is now turned over and a special type 1001S black ink and solvent 1052S supplied by Pannier Corp., Pittsburgh, Pa. is used on the glossy side of the film to add odd shapes and tight curves.

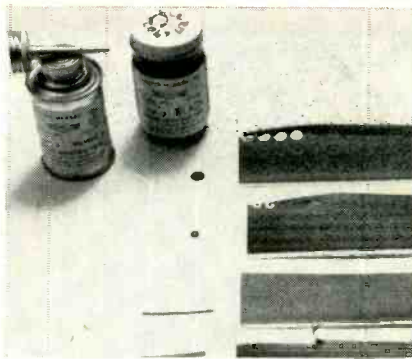

New art materials for designing printed circuits include special plastic film, ink, solvent and pressure-sensitive tape

When a two-sided circuit is to be reproduced, the pattern of the second side is drawn on a separate piece of film. The two sides are then placed back-to-back. The trans-

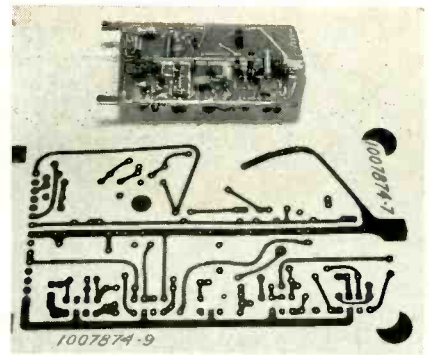

Assembled circuit, with example of art master revised many times without showing evidence of change

parent film allows exact corrections to be made with the special ink for more perfect registration. Changes are made simply by moving the tape or retaping. The ink wipes off easily from the glossy side of the film, using a rag moistened with the 1052S solvent.

The wrinkled finish of the black tape may produce highlights on the negative due to the intense lights used in photography. This can be eliminated completely by spraying Crescent Matton, manufactured by Crescent Portrait and Frame Co., East Cleveland, Ohio, over the finished master. The spray will not affect the ease of making changes in the master copy.

Design of the Month: STEPPER SWITCH

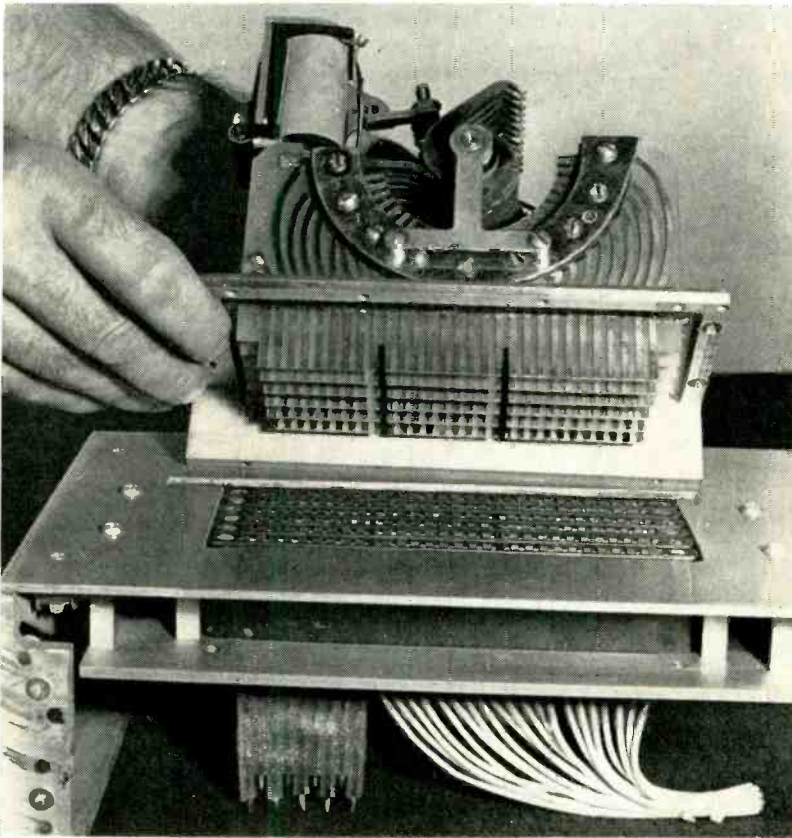

Six etched wiring boards provide all contacts, wiring and terminals for 12-deck, 26-position stepper switch developed at Northrop Aircraft for use in ground equipment of Snark intercontinental missile. Copper-clad epoxy-glass-fiber laminate is gold-plated to prevent oxidation of the plug-in contacts on one end of each strip, and rhodium-plated at the other end for improved mechanical strength of wiper contacts. Use of boards simplifies assembly and permits plugging complete switch into 348-contact socket. A malfunctioning switch can thus be replaced in a few seconds. Switch is currently being manufactured by Electrodynamic Division of United Geophysical Corp., Pasadena, Calif.

Rollers in Viewer Hold Large Circuit Diagrams

QUICK ACCESS TO any of up to 80 different circuit diagrams is achieved with a simple arrangement of two rollers and a frame in the missile development laboratory of Northrop Aircraft's Hawthorne, Calif. plant. The blueprints are pasted together end to end and rolled up on the hand-cranked rollers. Diagrams pertaining to a particular job can be run back and forth across the viewing area as required during assembly or testing of a complex airborne electronic system. A strip of Scotch tape anchors each end of the print strip to a roller.

On the model that holds 80 prints, an index card on the front of the stand identifies each print. An operator thus knows how far, how fast and in what direction to

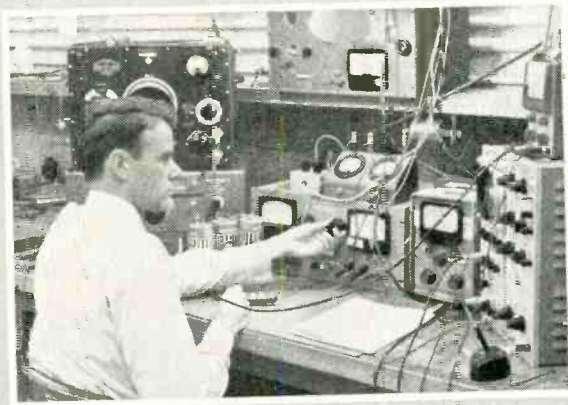

RESEARCH AND DEVELOPMENT

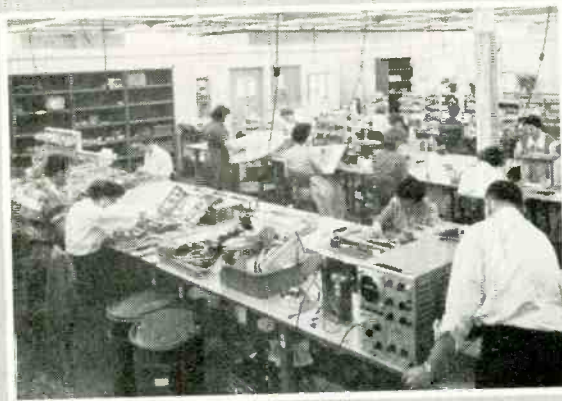

PILOT LINE PRODUCTION



FINAL ASSEMBLY

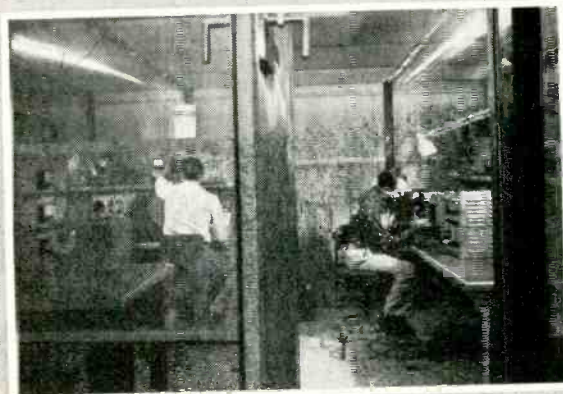

TESTING IN SCREEN ROOM

COMMUNICATIONS at Ramo-Wooldridge

Communications activities at The Ramo-Wooldridge Corporation include research, development, and manufacture of advanced types of radio communication systems, ground-reference navigation systems, and electronic countermeasure systems. Major programs are in progress in each of these fields.

New and unusual techniques have been employed to provide systems having a high order of security in the transmission of information, broad flexibility in combating unfavorable signal propagation conditions, and substantially greater information capacity per operating channel.

Some of the techniques used have made possible an increased range for given levels of transmitter power and reliability of communications. Others have provided specific advantages in very long distance communications or in operational situations requiring unique signaling capabilities. Developments in navigation systems have resulted in new equipment that is suitable for the guidance of aircraft at long ranges from their bases.

In the work currently under way, some systems are in the laboratory development stage, some in the flight test stage, some are in production. Several types of systems developed and manufactured by Ramo-Wooldridge are in extensive operational use.

*Openings exist
for engineers
and scientists
in these fields of
communications
activities:*

Systems study and analysis
Airborne transmitters
Transistorized video and pulse circuitry
Airborne receivers
Reconnaissance systems
Digital communications systems

The Ramo-Wooldridge Corporation

5730 ARBOR VITAE STREET • LOS ANGELES 45, CALIFORNIA

ENGINEERS!

**ARE YOU
LOOKING FOR
DIVERSITY?**

You can work in these fields

at **Bendix**

in Southern California

Telemetering

Servo Valves

Airborne Radar

Miniature Electric Motors

Missile Guidance

Underwater Sonar

Industrial Sonics

Aircraft Hydraulics

Bendix-Pacific offers you this broad cross section of absorbing tasks.

Here, in Southern California, you will find excellent positions open for electronic, hydraulic and mechanical engineers at all levels. At Bendix-Pacific the diversity of work never traps you in the monotony of a one-product job.

Write us today or mail the handy coupon for complete information.

W. C. Walker, Engineering Employment Mgr.
Pacific Division, Bendix Aviation Corp.
11600 Sherman Way, North Hollywood, Calif.

I am interested in this engineering field _____
I am a graduate engineer with _____ degree.
I am not a graduate engineer but have _____ years experience.

Name _____
Address _____
City _____
Zone _____ State _____

PRODUCTION TECHNIQUES

(continued)

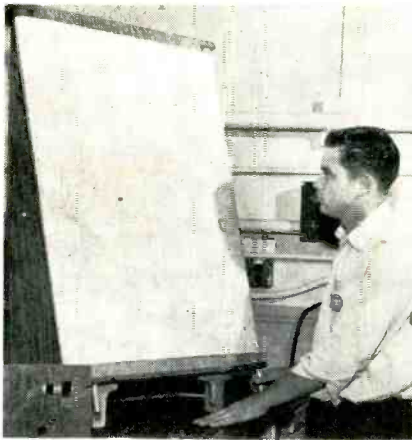

Simplest version of viewer. Crank at right moves print to right; for opposite direction, crank on left-hand roller is used

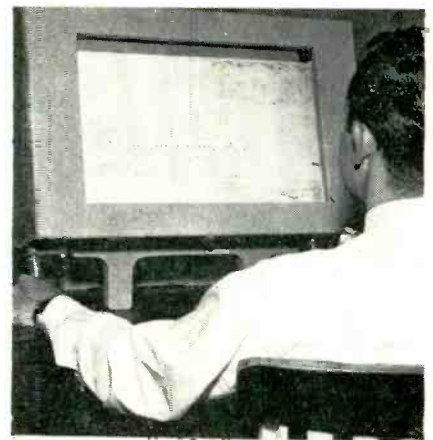

More elaborate desk-top viewer with back illumination is 26 inches wide, 12 inches deep and 18 inches high

turn for access to a desired print. Another model in a simpler frame holds up to 30 feet of prints. In addition to speeding access to the

desired print in a large set, the device keeps prints clean and smooth, and reduces the space needed for viewing large prints.

Cutting And Stripping Long Coaxial Cables

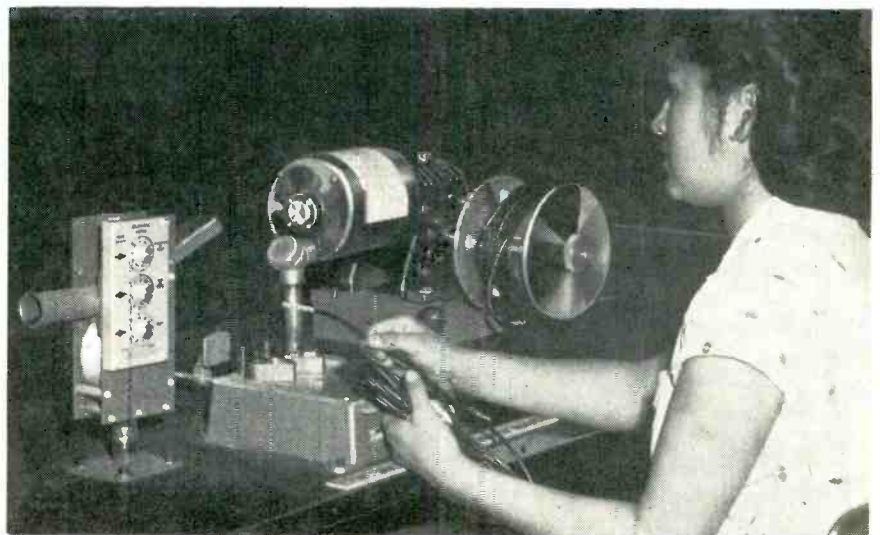

Former Navajo rug weaver now prepares coaxial cable at work position that combines measuring (left), coiling (right) and stripping (center)

LONG RUNS OF coaxial and multi-conductor cables are measured at high speed, cut, stripped and coiled at a single work position in the new Flagstaff, Arizona plant of Lear Inc. This plant taps a large labor pool of Navajo Indians, who possess above-average manual dexterity. It is expected that over 100 Navajos will be at work by this spring, performing electronic sub-assembly operations having a high labor content. This includes the assembly of wiring harness, preparation of cables with and without connectors, and carefully controlled

tinning of critical leads for airborne electronic units.

► **Preparing Coax** — For long lengths, a large spool of cable is placed on a shaft supported by brackets mounted on the end of the assembly bench. The cable comes up over a free-turning roller mounted at the top end of the bench, then runs through a measuring device mounted at the left of the work position. This is made by Olympic Instrument Laboratories, Cove, Washington and has three dials, reading in feet with quarter-

R-B-M Miniature Multipole Relays of Proven Reliability

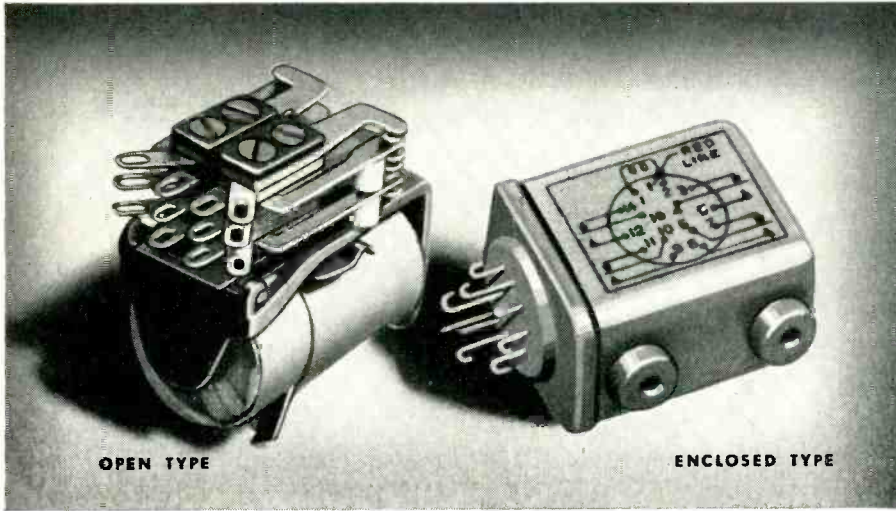

OPEN TYPE

ENCLOSED TYPE

Light weight, Small Size Open and Hermetically Sealed Types for Electronic and Communication Application

APPLICATION: R-B-M Miniature Multipole Relays are used where the prime factors in switching electronic circuits are small size, light weight and reliability. These proven designs are produced for switching low power circuits, low capacitance circuits and power circuits. 125° C insulation now available on some versions. Coils can also be designed for plate circuit.

CONSTRUCTION:

Magnet Frame—Four sizes available on open type relays and three sizes on hermetically sealed type.

Contacts—Cross-bar palladium welded to nickel silver springs or button contacts on Beryllium copper springs.

Terminals and Mountings—Glass headers provided with either solder or plug-in type terminals with many various types of mountings available. Octal type plug-in headers can be provided on the HL enclosure. Plug-in terminals to fit either 9 or 14 pin standard sockets. Maximum of 14 pins for solder connections.

TYPICAL SPECIFICATIONS *

Open	Maximum Coil Resistance (OHMS)	Minimum Power Requirements Per pole at 25° C (WATTS)	Maximum Contact Form With rated current at 32 V.D.C. or 115 V.A.C. (non-inductive load)	Maximum Coil Watts	Enclosed
SM	9,000	.2	4 PDT 5 Amps. or 3 Amps. 6 PST 3 Amps.	3.75	HSM
SMD-2	9,000	1.0	SPNO Parallel Contacts Make 80 Amps. Break 20 Amps. at 32 V.D.C.	3.75	HSMD-2
SC	18,500	.16	4 PDT 5 Amps. or 3 Amps. 6 PST 3 Amps.	4.5	HFSC
SA	18,500	.14	4 PDT 5 Amps. or 3 Amps. 6 PST 3 Amps.	4.5	HLSA
SM-RF	9,000	.2	SPNO, SPDT, DPNC, SPNC, DPNO	3.75	HSM-RF HLSM-RF
SAD-2	18,500	1.0	SPNO Parallel Contacts. Make 80 Amps. Break 20 Amps. at 32 V.D.C.	4.5	HLSAD-2

*Other ratings and specifications available.

For additional information write for Bulletin No. 1050



See Us at Booth 2525, IRE SHOW, March 18-21, New York

RBM DIVISION

Manufacturers of Magnetic Controls and Devices / LOGANSPORT, INDIANA



other outstanding
*ESSEX ENGINEERED
production proven products

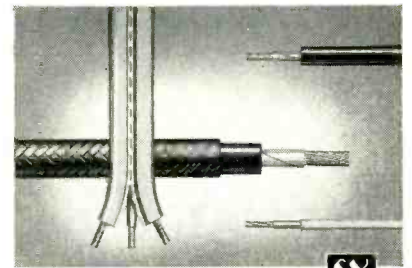

WIRE AND CABLE

A full "Extra Test" line of lead, test lead, appliance, automotive and refrigeration wires, plus submersible pump cable and 200° C. Sil-X insulations are examples of the versatility of "Essex Engineering".

Wire and Cable Division

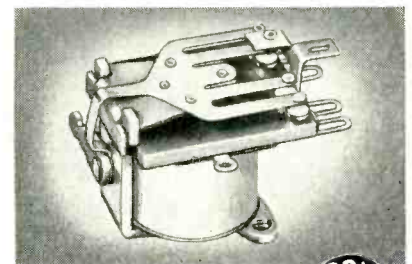

MINIATURE RELAYS

The Type MS Miniature Sensitive Relay is ideal for any application requiring a compact, highly reliable single pole D. C. device, where a low cost solution is required because of volume usage and competitive problems. Request Bulletin No. MS-1.

R-B-M "Control" Division

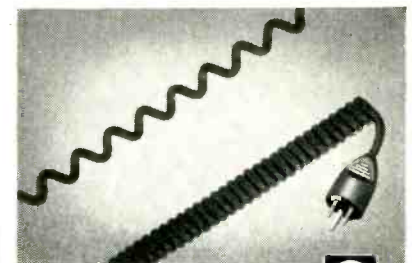

COILED CORDS

The "spring" in Coiled Cords automatically synchronizes with moving components that are electrically powered. There are no looping, tangling cords in the way... because Coiled Cords extend and retract as needed. Write for new literature.

Cords Limited Division



WE COULDN'T SHAKE ITS ACCURACY

This unretouched photograph shows the Lear Miniature Rate Gyro strapped to a jackhammer, riding side-saddle through two hours of pneumatic nightmare. After this "shakedown run" the gyro still performed up to the most exacting specifications set for the newest Air Force, Navy and Army missiles. This gyro is available right now. How many do you need?

LEAR MINIATURE RATE GYRO



LEAR INC.,
GRAND RAPIDS DIVISION,
GRAND RAPIDS, MICHIGAN

© 14

DATA

ON THE NEW LEAR MINIATURE RATE GYRO



RUGGED AND DURABLE—It has been vibrated up to 20 G's and 2000 cps. and submitted to shock up to peaks of 110 G's without significant effect.

UNIVERSAL OUTPUT—Electro-magnetic pick-off supplies 6 volts, 400 cps. into a 10,000 ohm load at maximum rate input. Thus, units of different maximum rates may be interchanged without modification. Unit is also available including integral demodulator in a mounting base for applications requiring a DC signal output.

HIGH ACCURACY—Unit weighs only 1.2 pounds, measures only 1½" diameter by 3½" long, yet resolution, threshold and hysteresis closely approach zero rate.

MINIMUM "CROSS-TALK"—Patented design of torsion bar provides previously unrealized cross axis stiffness. Movements in insensitive axes virtually eliminated.

LOW THERMAL NULL SHIFT—Use of thermally compatible materials for all associated parts brings about new lows in the amount of null shift resulting from temperature changes.

UNIFORM DAMPING—Through selection and close control of piston and cylinder materials and damping fluid, the damping orifice varies with temperature to uniformly compensate fluid viscosity variation. Damping is thus maintained at $.7 \pm .3\%$ critical throughout the operating temperature range of -65°F to $+165^\circ\text{F}$ without the use of heaters.

VERSATILITY—Unit is available with either 26 or 115 volts, 400 cps., 3-phase or 115 volts, 400 cps. split single phase motor. Can be supplied for any maximum rate required. Unit is readily adaptable to requirements involving different signal outputs and damping characteristics. 2 and 3 axis packages also available.

LEAR

Want more information? Use post card on last page.

ELECTRONICS — March 1, 1957

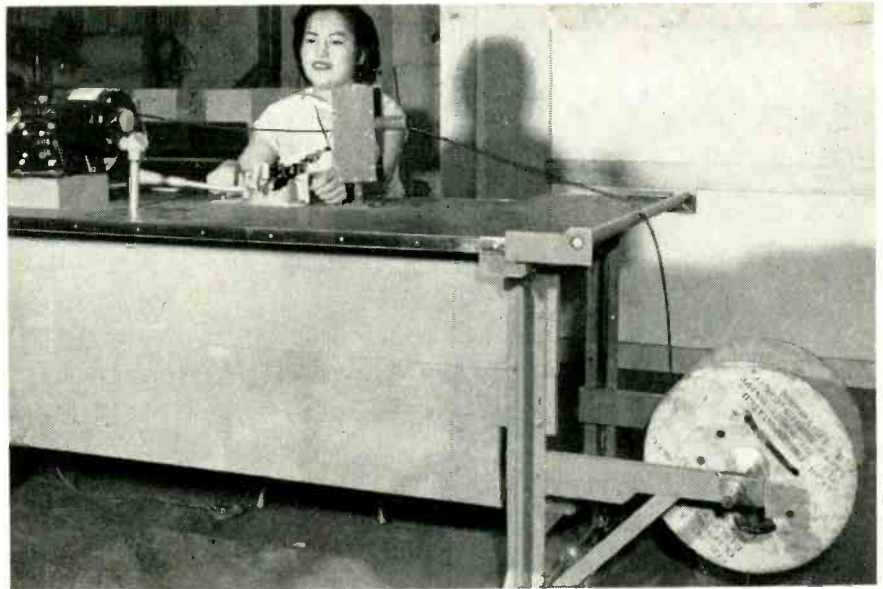

Method of mounting spool of coaxial cable at end of bench

foot divisions, in tens of feet and in hundreds of feet respectively.

A hand-operated lever cuts the cable at the correct point when the dials read the desired length. Operating the cutter resets the indicator dials to zero.

To run off a length of cable, the operator pulls the projecting end across from the cable meter to a motor-driven coiling reel at the right, and anchors the end in a spring clip on the reel. She then starts the reel motor by pressing a foot-operated rheostat, to wind on the desired footage as indicated on the dials. Use of the rheostat with

the motor and gear box permits starting and stopping slowly while winding long lengths at high speed. A hand-operated braking system prevents overrun and backlash when slowing down.

After the cable length is coiled and cut, the operator pushes the end through the jaws of an Ideal Industries stripper to a preset stop, then pulls back the cable to strip the outer jacket off the metal-braid shield. With the cable completed, the operator loosens a knurled knob and takes the flange off the motor-driven reel, then slips off the coil of cable.

Press Crimps Metal Electrode Over Ceramic

PRIOR TO INSTALLING hydraulic equipment, crimping of thin-metal electrode tubes to ceramic insulators presented a critical problem in the Los Angeles plant of Electrical Products Corp. Through trial and error, an operator had to learn to apply the exact pressure necessary to crimp pieces together without fracturing the ceramic insulator. This proved to be a costly, time-consuming procedure.

To cut costs, speed up production and insure product uniformity, the production setup was converted to use of a hydraulic Multipress manufactured by Denison Engineering Co., Columbus, Ohio. An unskilled operator with a six-sta-

tion index table on the new press now turns out 15,000 pieces per day, as compared to 6,000 pieces using the old manual pressing method. Labor fatigue is also greatly reduced because tube parts are hopper-fed to the operator, who places the ceramic insulator on the tube and fits it into the holder at each station of the index table.

► **How It Works**—The crimping press consists of a spider ejection mechanism, six cam-operated sliding split-type crimping dies and a die-closing cam. As completed electrodes are ejected by the spider mechanism, new tubes and ceramic inserts are placed in their respec-

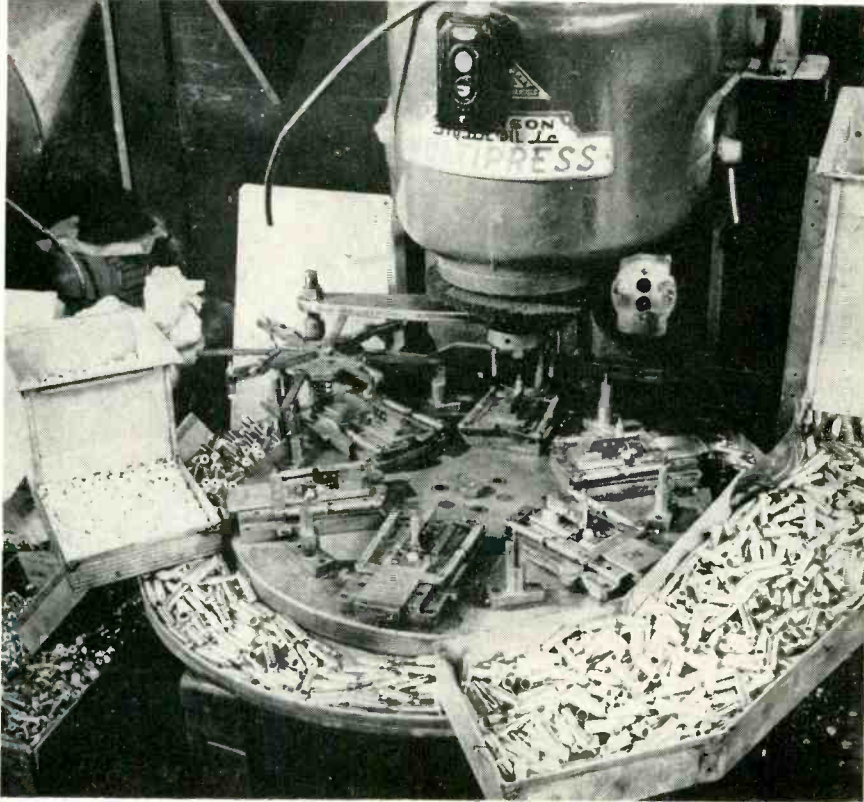

Metal tubes and ceramic insulators, transferred by operator from hoppers to holders on revolving table, are indexed to press station where sliding die closes and descending ram crimps metal tube. Assembled unit is picked up by spider mechanism at left rear and dropped into tray. Extension arm on press ram actuates spider

tive holders and are automatically indexed to the pressing station. At this point, a cam brings the crimping dies together around the ceramic insert. The ram then descends, pressing the tube downward into the die and crimping it to the insert.

The spider ejection mechanism is attached to the ram banjo. When the ram descends the mechanism is pushed downward against spring tension to a pick-up position where

the clamp arm grasps the completed electrode. As the cam rises, the mechanism is raised by the spring, lifting the electrode.

When the ram cycle is ended the table indexes, causing the spider-actuating pin to strike the spider arm. In doing this it revolves the arm in synchronization with the motion of the table until the next index station is reached. The completed electrode is dropped into a tray located at the side of the table.

Plug-In Toroid Assembly Techniques

By **ARTHUR J. ROSE**

*Chief Engineer
Magnetics Research Co.
White Plains, N. Y.*

AN INEXPENSIVE and rapid method of producing an assembly that includes a five-winding toroidal core and a selenium rectifier involves foolproof identification of the coil leads and their connection to precisely positioned pins for insertion in printed wiring boards. The assemblies are used in great quantities as elements of shift-register

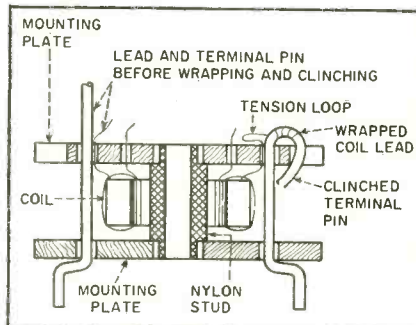

Cutaway section of coil assembly. Clinching terminal pins over through slots in coil mounting plates provides a rugged yet inexpensive assembly

To the ENGINEER of high ability

Through the efforts of engineers The Garrett Corporation has become a leader in many outstanding aircraft component and system fields.

Among them are:

- air-conditioning
- pressurization
- heat transfer
- pneumatic valves and controls
- electronic computers and controls
- turbomachinery

The Garrett Corporation is also applying this engineering skill to the vitally important missile system fields, and has made important advances in prime engine development and in design of turbochargers and other industrial products.

Our engineers work on the very frontiers of present day scientific knowledge. We need your creative talents and offer you the opportunity to progress by making full use of your scientific ability. Positions are now open for aerodynamicists . . . mechanical engineers . . . mathematicians . . . specialists in engineering mechanics . . . electrical engineers . . . electronics engineers.

For further information regarding opportunities in the Los Angeles, Phoenix and New York areas, write today, including a resume of your education and experience. Address Mr. G. D. Bradley



9851 So. Sepulveda Blvd.
Los Angeles 45, Calif.

DIVISIONS
AiResearch Manufacturing,
Los Angeles
AiResearch Manufacturing,
Phoenix
AiResearch Industrial
Rex - Aero Engineering
Airsupply - Air Cruisers
AiResearch Aviation
Service

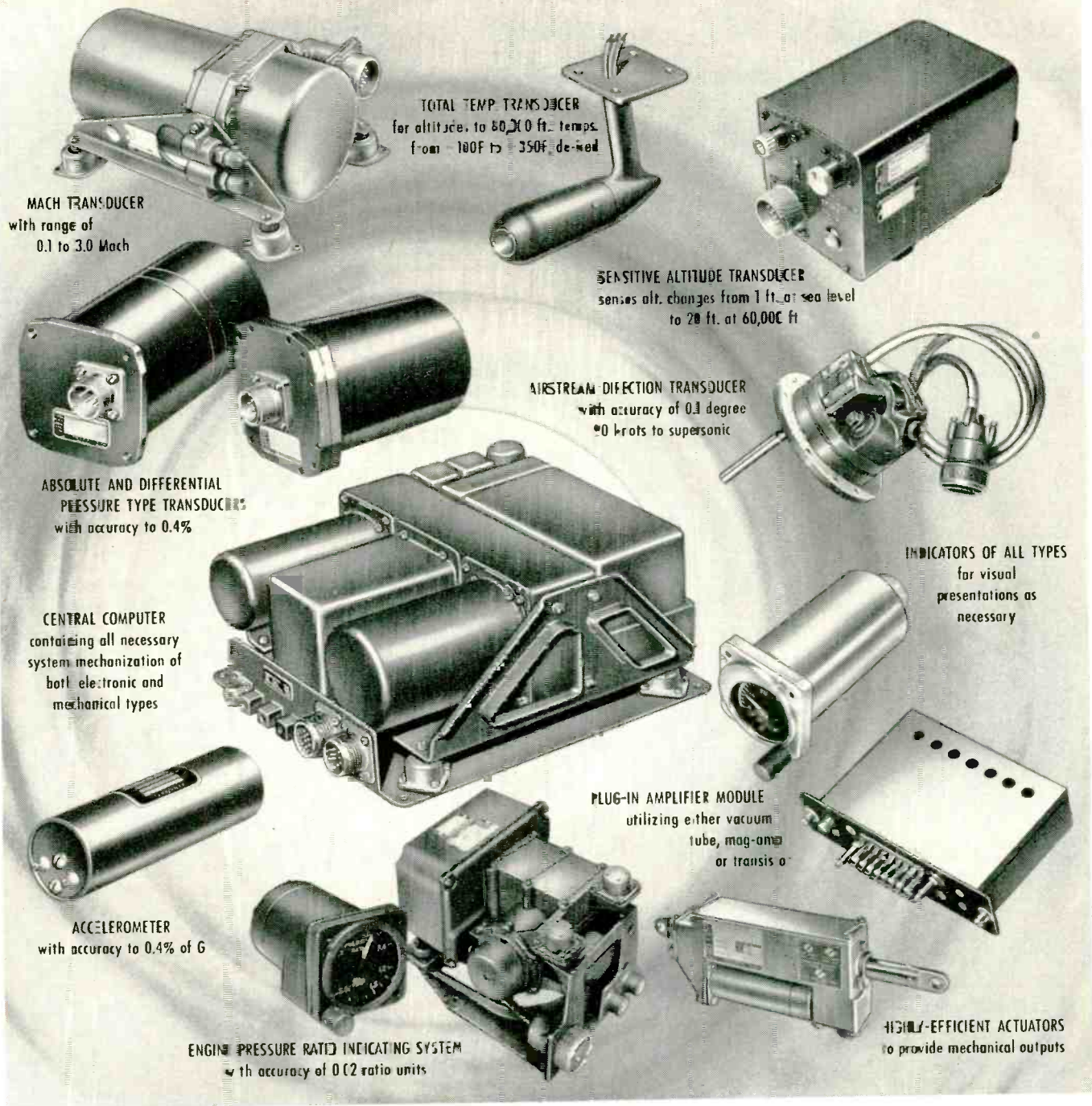

**Finer components
mean better
air data systems**

AiResearch makes transducers, computers and indicators of superior sensitivity and accuracy in *all* required parameters. These can be combined into systems that provide the air data you require and convert it into any desired type of information or impulse. The products shown in the above illustration indicate some of the areas in which we are thoroughly experienced. If desired, we will take complete system responsibility. We invite inquiries to meet the most rigid specifications.
Qualified engineers are needed now. Write for information.



Los Angeles 45, California • Phoenix, Arizona

Designers and manufacturers of aircraft systems and components: REFRIGERATION SYSTEMS • PNEUMATIC VALVES AND CONTROLS • TEMPERATURE CONTROLS
CABIN AIR COMPRESSORS • TURBINE MOTORS • GAS TURBINE ENGINES • CABIN PRESSURE CONTROLS • HEAT TRANSFER EQUIPMENT • ELECTRO-MECHANICAL EQUIPMENT • ELECTRONIC COMPUTERS AND CONTROLS

LOOK TO TOBE FOR PROGRESS

electronic interference filters

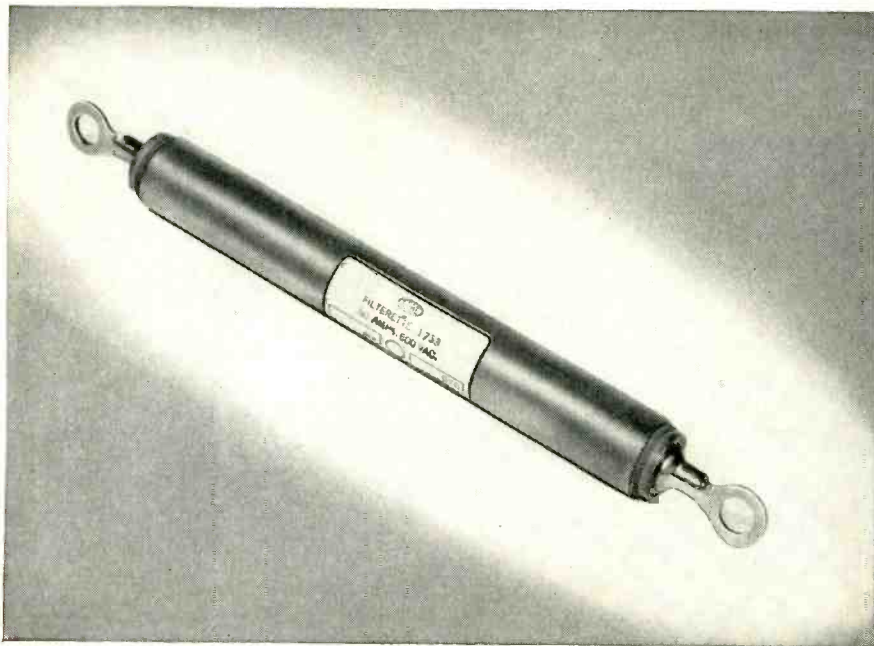

TOBE brings unequalled experience to the solving of your filtering problems. TOBE'S advanced design-techniques, and the technical data accumulated by TOBE filter specialists over the years, meet your problems with solutions that are quicker, more efficient, and more reliable. For all your filtering needs, look to TOBE DEUTSCHMANN, the oldest name in interference filters.

TOBE FILTERETTES, available in wide range of ratings, sizes and mounting styles, are engineered to operate under the most severe environmental conditions.

Tobe Exclusives:

Feed-thru capacitor construction in filterettes.

Miniaturization with maximum quality.

Guaranteed attenuation characteristics—under full-load operating conditions.

We invite inquiries on specific applications. The services of our engineers are always available. Write TOBE-DEUTSCHMANN Corporation, Norwood, Mass., the acknowledged authority on electronic interference—manufacturers of "FILTERETTES".



TOBE DEUTSCHMANN • CAPACITOR PIONEERS SINCE 1929

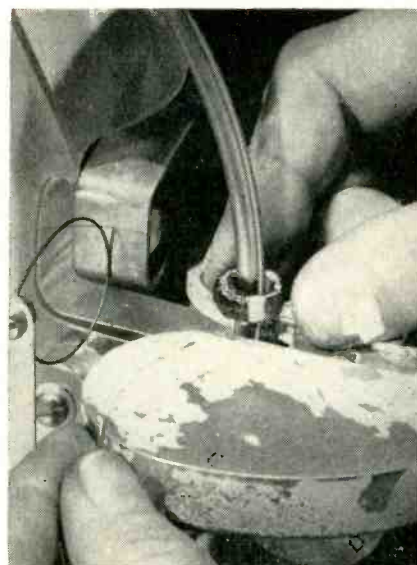

Winding of toroidal coil. Self-adhesive color tabs identify each loop brought out for connections

types of magnetic storage and data handling systems. The cores themselves are quite sensitive to pressure of any sort. They quickly depart from their rectangular hysteresis loop property if subject to strain or pressure, hence handling and mounting techniques are of prime importance.

► **Lead Identification**—The large number of windings (five) on a core diameter of $\frac{1}{2}$ inch presents a problem in the identification of the various leads. Color coding at the winding machines is practical and necessary, but somewhere in the production process, stripping of insulation and trimming of leads is necessary. This problem has been met by an extremely simple technique that lends itself well to high production.

To avoid the use of expensive headers that employ delicate pins

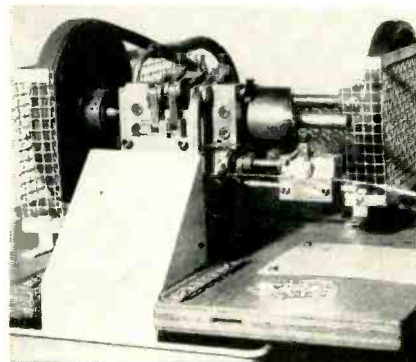

Automatic wire pin forming machine cuts and forms terminal pins for coil assembly at rate of 10,000 per hour

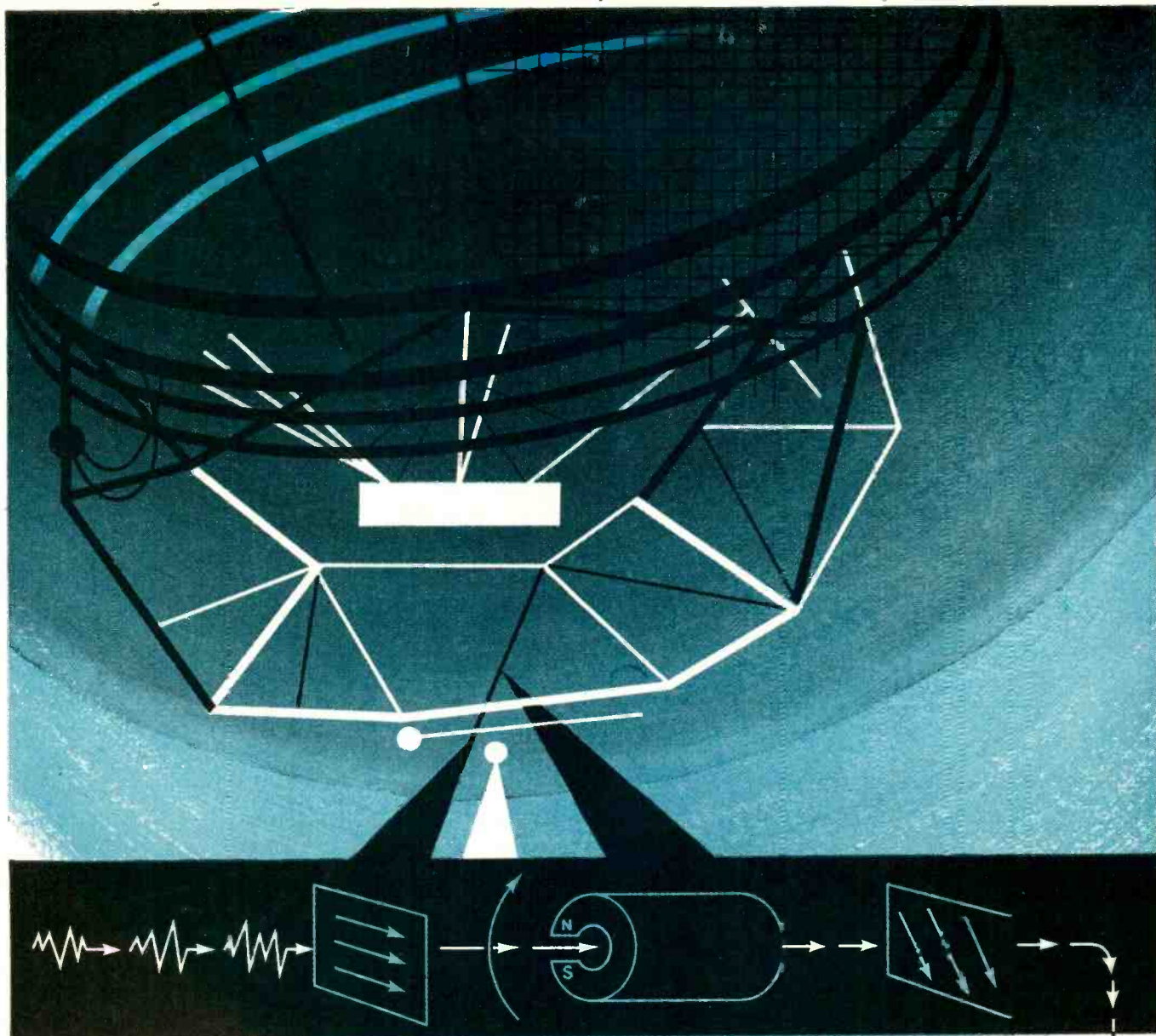

in radar load isolators, too

CRUCIBLE PERMANENT MAGNETS

give maximum energy. . . minimum size

Special applications, such as radar load isolators, demand compact but powerful magnet assemblies. And this is but one of the many places where the *consistently* higher energy product provided in Crucible Alnico magnets pays off.

These Crucible Alnico permanent magnets can be sand cast, shell molded, or investment cast to exact size, shape or tolerance requirements . . . and in any size from a mere fraction of an ounce to hundreds of pounds.

The design and production of permanent magnets has been a Crucible specialty ever since Alnico alloys were discovered. It's one of the good reasons why so many people bring their magnet applications to Crucible. Why don't you? *Crucible Steel Company of America, The Oliver Building, Mellon Square, Pittsburgh 22, Pa.*

CRUCIBLE

first name in special purpose steels

Crucible Steel Company of America

Lapp

TUBE SUPPORTS

for air-cooled power tubes

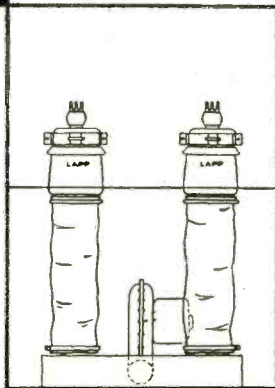
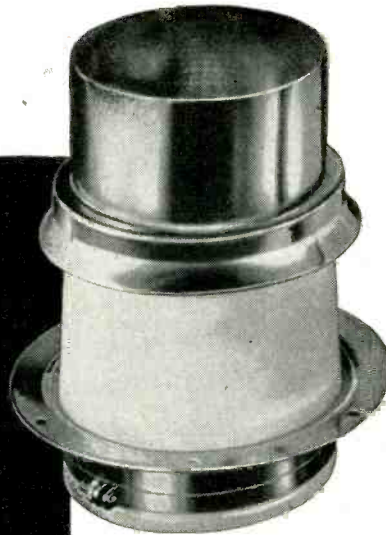

Since forced-air-cooled tubes were first introduced, equipment manufacturers have been designing their own supports, many of which

have been produced by Lapp. To standardize the great variety of tube support designs, Lapp set out to design a complete line which is now available and offers the equipment manufacturer a valuable service by way of more economical production, interchangeability and availability of replacement units. Lapp Tube Supports are compact, efficient and attractive in appearance. Their duty is threefold... they support the tubes, insulate, and furnish an air duct which channels air over tube fins for maximum cooling. Write for Bulletin 301, with complete description and specification data. Lapp Insulator Co., Inc., Radio Specialties Division, 910 Sumner Street, LeRoy, New York.

Lapp

swaged into position, a rugged cage assembly was developed that uses phenolic stampings and pins made from ordinary tinned copper wire. An automatic machine of the type used in the watch industry for making small wire springs is used for forming and cutting the pins at a rate of 10,000 per hour.

Using standard toroidal winding machines, the cores are wound by skilled operators who pull out loops of wire at the end of each set of windings. A five-winding coil has four loops and two end wires. Each loop is identified by a piece of colored pressure-sensitive tape. Special tape with bands

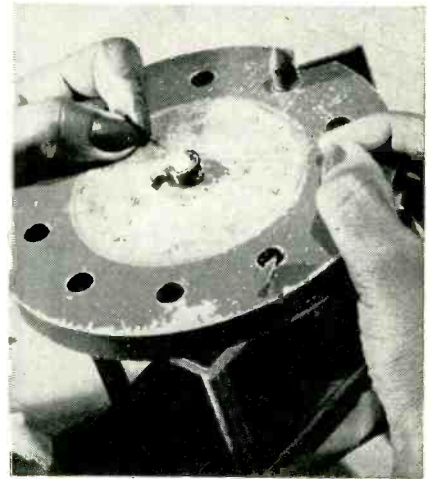

Coil-mounting fixture assures positive identification of lead connections by stringing coil leads through radial holes in coil-mounting plate

of color in sequence is dispensed one color at a time.

Leads are then identified as either top or bottom and of a particular color. Each loop is comprised of a top and a bottom wire. The end wires are either top or bottom.

► **Mounting Fixture**—As a step in the assembly process that virtually eliminates wrong lead connections, a special mounting fixture is used. It strings each lead through the upper mounting plate in a relationship to the terminal pins so that there is no question as to where each lead is to be soldered.

Because the pin connections must be in two linear rows of five and the leads from the coils are radial, conversion of these two

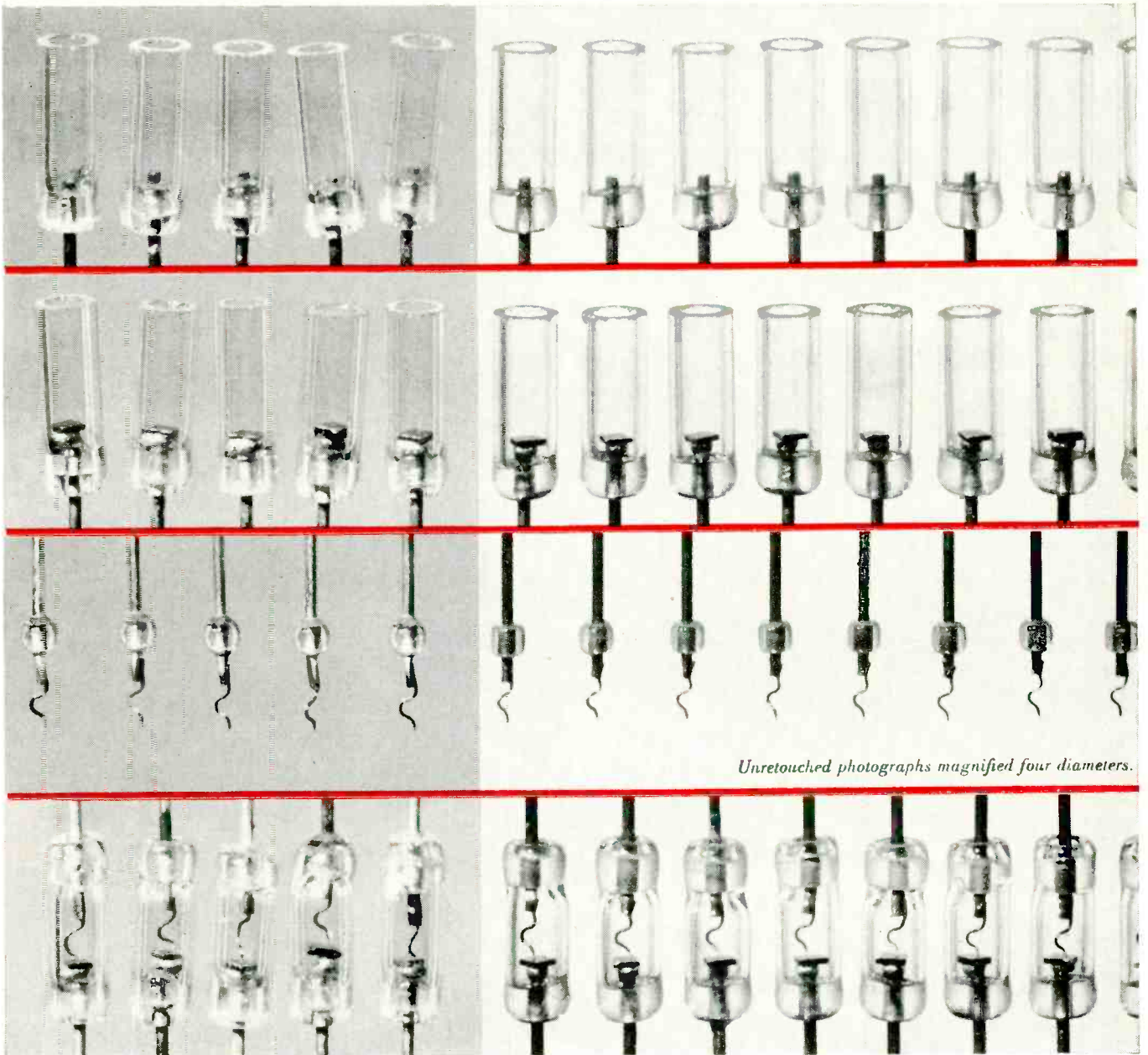

Unretouched photographs magnified four diameters.

Hand assembled diodes ↑ **COMPARE** ↑ Automatically assembled CBS diodes

UNIFORMITY
by and for automation

The increasingly automatic assembly of electronic equipment is placing serious limitations upon component manufacturers. Rigid, tight tolerances must be maintained to avoid jamming the automatic machines. This spells automation for components, too.

CBS has done something about it. On seven integrated machines, CBS glass diodes are automatically assembled, packaged, tested. The picture tells the story . . . compares the results of this automatic assembly with that of ordinary hand assembly. The controlled uniform quality is apparent. As you would expect, the uniformity is both mechanical and electrical.

Take advantage of CBS Advanced-Engineering. Specify CBS glass diodes for uniformity . . . for dependability . . . for automatically controlled quality.



semiconductors

Reliable products
through Advanced-Engineering

CBS-HYTRON

Semiconductor Operations, Lowell, Mass.

A Division of Columbia Broadcasting System, Inc.

HIGH RESISTANCE MEGOHMMETER

a modern
design for
modern needs



ONLY \$340

UP TO 50,000,000 MEGOHMS

UNCROWDED SCALE

TEST VOLTAGE VARIABLE 100-600 V. DC

SAFE TEST TERMINALS

NO METER SLAM ON UNCHARGED CONDENSERS

4 1/2" METER SCALE

BUILT-IN CONDENSER DISCHARGE

A brand-new high-resistance megohmmeter with brand-new features found in no other megohmmeter at any price!! Designed to fill today's needs in checking the new insulation materials of extremely high values. The first megohmmeter with an uncrowded, easy-to-read upper scale end. Ideal for both laboratory and production use. Power supply 115 V, 50/60 cycle.

... this is only part of the story ...
send for descriptive literature ...

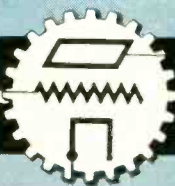

Industrial Instruments

89 COMMERCE ROAD, CEDAR GROVE, N. J.

geometric factors has to be made. A mounting plate was designed that provides a circular row of holes for each of the coil leads and two linear rows of holes for the terminal pins. The small space available necessitated using a common hole that appeared in the midposition of the linear rows.

At each position of the hand-operated turntable of the fixture, a hooked needle is brought up and down through one of the holes in the coil-mounting plate by a foot pedal. After setting the coil on a nylon stud pressed into the coil mounting plate, the operator stops at each turntable position, hooks the appropriate lead under the hook and draws it through the plate. Wire loops are cut as required. The numbering sequence is marked T for top and B for bottom in five colors. A skilled operator can mount as many as forty coils per hour on this fixture.

► **Stripping**—After all coil leads have been drawn through their holes in the mounting plate, a chemical stripping solution is

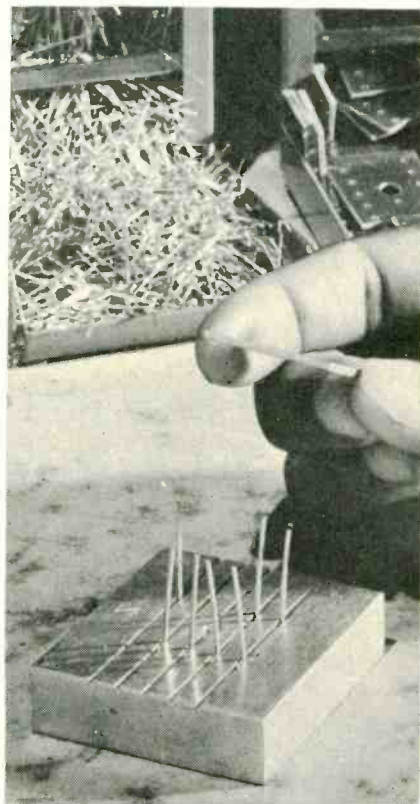

First operation on final assembly line. Operator is placing lower terminal plate over upright terminal pins in jig

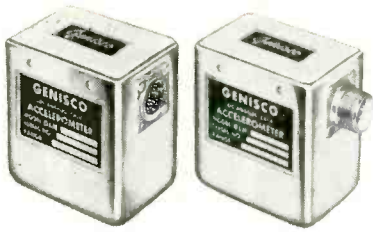

Model GLH

A rugged magnetically damped instrument with low natural frequencies for low range. High-frequency production assures good price and delivery schedules. Available in ranges from ± 1 G to ± 30 G.

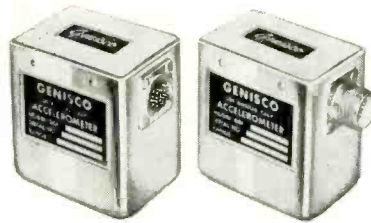

Model DDL

Magnetically damped low-range instrument available in ranges from ± 1 G to ± 30 G. Ultra-sensitive models supplied as low as ± 0.1 G. Certified to MIL-E-5400 and MIL-E-5272A. Especially good in severe shock and vibration applications. An acceleration-sensitive switch version of the DDL is designated as the Model DDS.

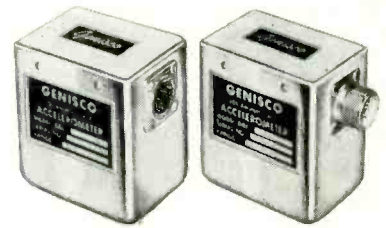

Model GAL

Incorporates a variable transformer a-c output with the magnetically damped sensory mechanism of the proven Models DDL and GLH. Superior reliability, life, resolution, and sensitivity. Available in ranges from ± 1 G to ± 30 G. Range as low as ± 0.1 G also obtainable.

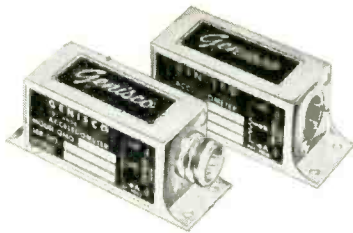

Model GMO

A rugged, miniature, viscous-damped instrument with ranges from ± 2 G to ± 30 G. Unbalanced-range instruments also available. Medium high natural frequencies.

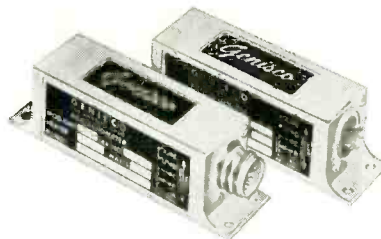

Model GMT

Basically a Model GMO with internal thermostat-operated heater, assuring maximum environmental stability within the instrument. Damping remains constant with change in ambient temperature.

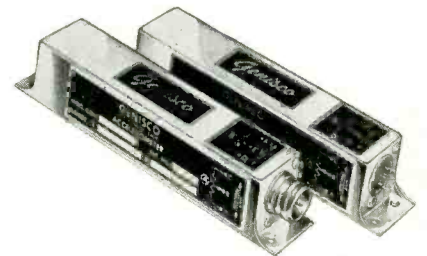

Model GDM

Miniature double-potentiometer instrument capable of sensing lateral acceleration in two mutually perpendicular planes (e.g., pitch and yaw). Ideally suited for missile and high-speed aircraft flight control systems.

NEW! GENISCO ACCELEROMETERS NOW GOLD PLATED FOR GREATER RELIABILITY

CASES GOLD PLATED INSIDE AND OUT—This new trend in instrument plating has two important advantages over tin plating or fusing. Being the least active metal, gold prevents the formation of crystalline "whiskers" inside the case which could reduce performance and even cause malfunction. Gold plating also assures positive protection against corrosion to the exterior of the case and, because of its excellent solderability, makes possible a more reliable hermetic seal. The new gold plating is available on *all* models at *no extra cost*.

Descriptive data sheets available on all models.

Please send request on company letterhead.



2233 Federal Avenue
Los Angeles 64, California

NEW CALIDYNE 177 SHAKER SYSTEMS



for vibration test

up to **5000 LBS.**
FORCE OUTPUT

up to **411 LBS.**
LOAD AT 10 G

The Model 177 is one of a new series of "wide-band" shakers designed for higher frequency operation and lower input requirements. It is the Basic Unit for five completely integrated CALIDYNE Vibration Test Systems. Oscillatory linear forces up to 5000 lbs. are generated and precisely controlled over wide ranges for vibration research and test of products up to 411 lbs. maximum load. Any of these five Vibration Test Systems using this New Model CALIDYNE 177 Shaker will enable you to:

1. Discover effects of "brute force" shaking on your assemblies and determine their ability to withstand vibrations far beyond those of normal operation.
2. Provide factual vibration data essential in determining mode shape, frequency and damping characteristics.
3. Determine results of fatigue testing at extremely high stresses and deflections.

CALIDYNE VIBRATION TEST SYSTEMS USING NEW MODEL 177 SHAKER

System Number	Type of Vibration	Force Output	Power Supply	Frequency Range	Maximum Load	
					10 g.	20 g.
1 177/80	Sinusoidal	3500 lbs.	Electronic	5-2500 cps.	261 lbs.	86 lbs.
2 177/180	Sinusoidal	5000 lbs.	Rotary	5-2000 cps.	411 lbs.	161 lbs.
3 177/186	Sinusoidal	5000 lbs.	Electronic	5-2500 cps.	411 lbs.	161 lbs.
4 177/190	Random or Sinusoidal†	5000 lbs.	Electronic	5-2500 cps.	411 lbs.	161 lbs.
5 177/190	Random†	5000 lbs.	Electronic	5-2500 cps.	411 lbs.	161 lbs.

†This system will perform with Random, Sinusoidal, Tape or Mixed Inputs.

A separate Bulletin 17700 details the specifications, performance data, basic components and accessories of the new Model 177 CALIDYNE Shaker and its five Shaker Systems. For engineering counsel in applying Controlled Vibration to your research and testing, call us here at CALIDYNE — Winchester (Boston) 6-3810.



See us at I.R.E. Booth 3222-24

THE CALIDYNE COMPANY

120 CROSS STREET, WINCHESTER, MASSACHUSETTS

SALES REPRESENTATIVES

Technical Instruments, Inc.
Waltham, Mass. (Twinbrook 3-1400)
Syracuse, N. Y. (Syracuse 3-7870)

G. Curtis Engel & Associates
Ridgewood, N. J. (Gibbst 4-1400)
Syosset, L. I., N. Y. (Walnut 1-5095)
Philadelphia, Pa. (Walnut 2-3270)

M. A. Odell Company
Westlake, Ohio (Trinity 1-8000)
Dayton, Ohio (Oregon 4441)

Pittsburgh, Pa. (Fremont 1-1231)
Detroit, Michigan (Broadway 3-5399)
F. R. Jordan, Inc.
Washington, D. C. (Oliver 2-4406)

Specialized Equipment Corp.
Cocoa Beach, Fla. (Cocoa Beach 3328)

Hugh Marston and Co.
Chicago, Ill. (Ambassador 2-1555)
Indianapolis, Ind. (Glendale 3803)
Minneapolis, Minn. (Colfax 7949)

Gerald B. Miller Co.
Hollywood, Calif. (Hollywood 2-1195)
San Diego, Calif. (Academy 2-1121)
Belmont, Calif. (Lytel 1-0365)

John A. Green Co.
Dallas, Texas (Riverside 1-3266)
Houston, Texas (Jackson 6-2959)
Tulsa, Oklahoma (Riverside 2-4657)

Tucson, Arizona (East 6-1266)
Denver, Colorado (Acoma 2-9276)

Albuquerque, New Mexico
(Albuquerque 5-8606)
Seattle, Wash. (Lander 3320)

CANADA
Measurement Engineering Ltd.
Amprior, Ont. (Phone 400)
Burlington, Ont. (Nelson 4-5686)

EXPORT
Rock International Corp.
13 East 40th Street, N. Y. 16, N. Y.
(Murray Hill 9-0200)

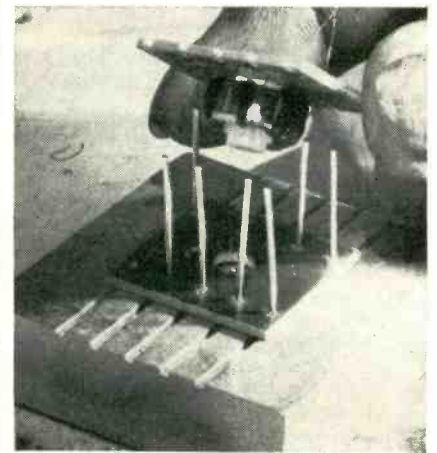

Second operator places mounted coil over terminal pins. Nylon spacer stud snaps into bottom hole and squares assembly

used to remove insulation and foreign matter from the leads. The advantage of having the coil on a mounting plate is obvious here. Should stripping solution get on the coil itself, the damage is final. However, the barrier of the mounting plate assures freedom from this source of production shrinkage.

► **Terminal Pins**—A cage assembly provides a flexible yet rugged means of fastening terminal pins. The bottom bends are accurately made by the forming machine. The upper part of the pin is bent over and down through the slots on the coil mounting plate by operators on the final assembly line.

Simple jigs with accurately laid-out holes and slots are used in assembly until the cage be-



All connections are soldered in one dip-soldering operation

BOOTH
2234
IRE
SHOW

ELCO TRONIC NEWS

Published by ELCO CORPORATION, M below Erie, Phila. 24, Pa., CU 9-5500

ENGINEERS COMMEND P-C LINE RELIABILITY-FACTOR

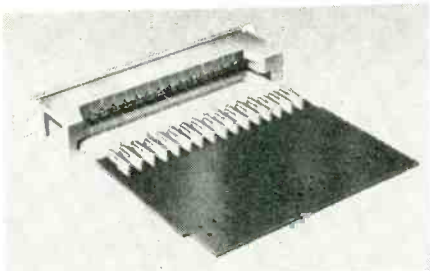

5000 Series Printed Circuit Connector: modular, may be built up to any desired size by stacking center sections.

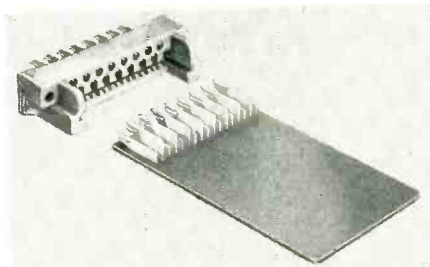

7000 Series Printed Circuit Connector: subminiature version of 5000 Series; available in 17 contact units; 5, 11, 23, 29, 35, 41, 47 contact units available soon.

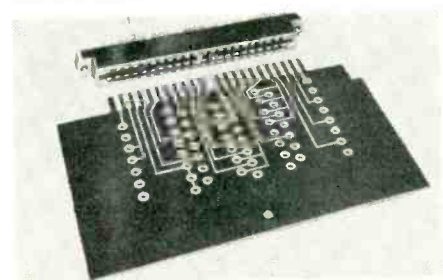

6000 Series Printed Circuit Connector: for use with board acting as a plug.

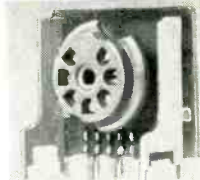

Printed Circuit Right-Angle Sockets: for use where vertical space is limited; available in 7 and 9-pins, with or without shield. Meets JAN Spec. requirements.



Printed Circuit Board-to-Board Connector: makes possible small sub-assemblies for tandem, perpendicular or parallel connections.

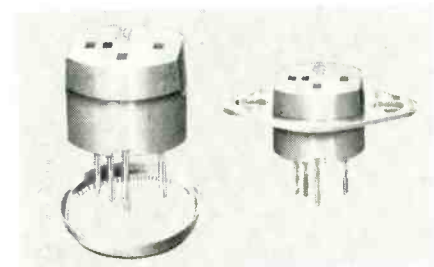

Universal Transistor Socket: eliminates need for socket change when used with transistors of in-line or triangular contact configuration.

ELCO P-C CONNECTORS, SOCKETS, SHIELDS WIN MAJOR ACCEPTANCE

Because of their reliability in laboratory tests and operating applications, Elco printed circuit components are being specified by more and more engineers. This stability, proved in both governmental and private projects, is the reason why Elco p-c components are fast becoming the industry's standard for comparison. For complete data

concerning the components illustrated here, please refer to coupon below.



Heat Dissipating Corrugated Shield: allows tube to operate at lower temperature than it would in open air without shield.

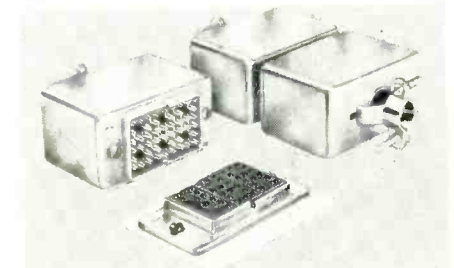

8000 Series Varicon Connector: subminiature version of standard Varicon; available in 16, 40 and 48 contact units. Soon: 8, 24, 32, 64, 80 contact units.

WHAT DO YOU KNOW ABOUT THE VARICON CONNECTOR?

At the extreme upper left hand side of this page, you will see two views of the famous Elco Varicon Connector. If you do not know about Varicon's better conductivity and how it gives you contact pressure at all times from all 4 sides, write for our Varicon Catalog—as well as our Socket & Shield Catalog for a complete cross-section of our products.

IF IT'S NEW...IF IT'S NEWS...IT'S FROM **ELCO**

CLIP TO COMPANY LETTERHEAD

Elco Corporation
M Street below Erie Avenue
Philadelphia 24, Pa.

Please send me Bulletins relating to components I am listing on the attached letterhead. Also forward me Varicon Catalog _____; and Socket and Shield Catalog _____.

Name _____

Title _____

WHEN YOU NEED RESISTORS WITH BETTER THAN MIL SPECS.

VICTOREEN CAN SUPPLY THEM

MIL specifications 10509A are good—but for applications in a high temperature area where more than the normal life-expectancy is required, specify Victoreen carbon deposited resistors.



These resistors are made by depositing a pure crystalline carbon, by pyrolysis of hydro-carbon vapor, on specially prepared, smooth-textured ceramic bodies. Silver-plated brass caps make positive contact with the silvered ends of the element to provide terminals of highest conductivity. Elements are sealed in an inert-gas filled glass envelope.

COMPARE THESE SPECIFICATIONS

MIL Paragraph		MIL 10509A Requirement	Victoreen Capabilities
3.3	Power Rating (Ambient Temperature)	40°C	70°C
3.7	Low Temperature Exposure (Change)	3%	1%
3.10	Moisture Resistance (Change)	5%	3%
3.4	Maximum Continuous Working Voltage at	40°C	70°C
4.6.10	Load Life (Test Condition)	40°C	100°C
4.6.10.2	Test Life Procedure (Minimum)	1000 hours	*2000 hours

*These units are being used in applications with life objective of 10,000 hours.

As shown in this derating curve, the Victoreen developed carbon deposited resistor is infinitely better than the commonly accepted types yet retains all the normal characteristics.

We invite your inquiry. Samples will be furnished for your testing.

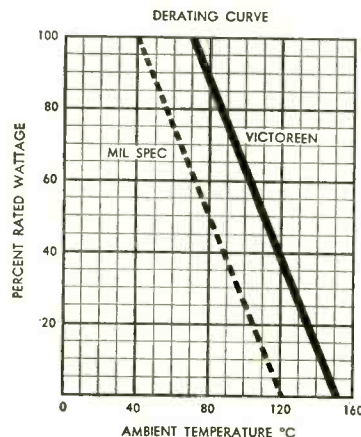

COMPONENTS DIVISION



The Victoreen Instrument Co.

5806 HOUGH AVENUE • CLEVELAND 3, OHIO

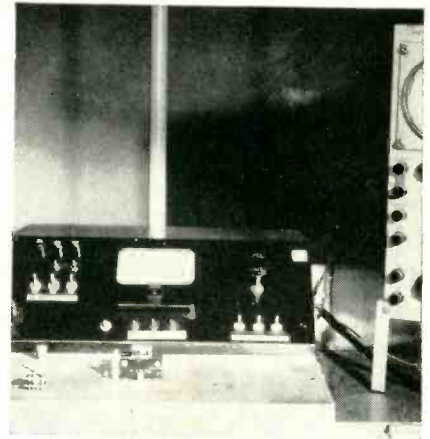

Completed cage assemblies on test fixture

comes self-supporting. In the first position, the operator inserts pins into the jig and places a bottom or terminal plate over the pins. One pin is left out for a later operation.

In the second operation the coil plate is set over the pins and pressed into place. Shoulders on the center stud position the plate and lock it in place.

At subsequent positions, each operator bends certain terminal pins over, clinches them, and/or wraps coil leads around the pins. The pins are wrapped while they are in a right-angle position, then clinched. A loop is left between the coil lead and the terminal pin to prevent lead breakage.

In a following line position the assembly is lifted from the jig, fluxed and dip-soldered. Mounting

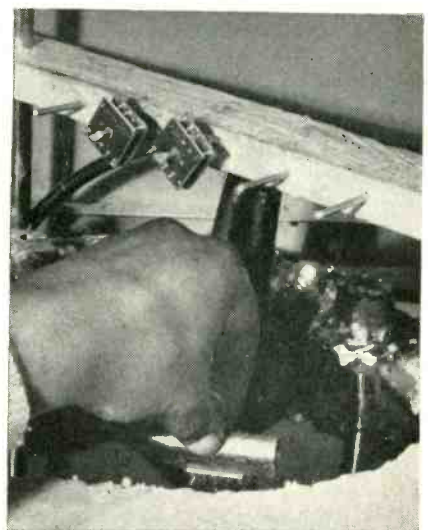

Assembly is moisture-proofed by dipping in a pliable wax while gripping terminals with large paper clip. Cores used in these assemblies are sensitive to strain, hence hard-setting compounds cannot be used for the incapsulating operation

If you use . . .



to interconnect . . .

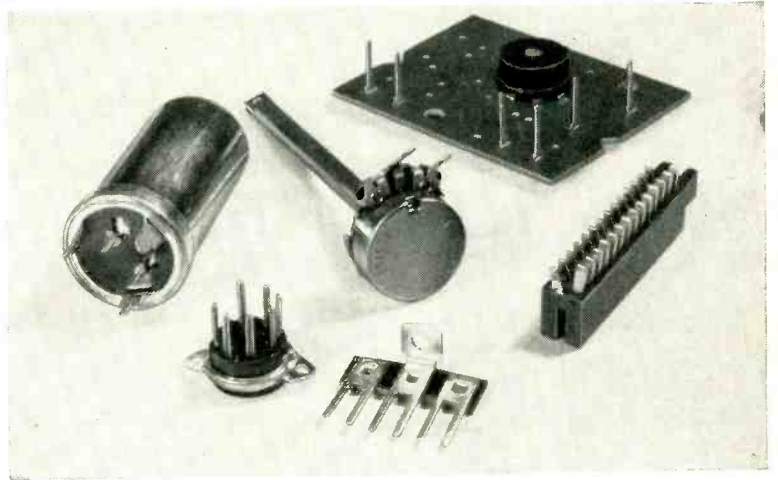

KELLER *Wire-Wrap*[®] TOOLS

Provide the fastest, lowest-cost method.

Solderless, wrapped connections are made by wrapping the wire around a terminal with sufficient tension to create a permanent electrical and mechanical bond. Interconnecting components with this method will save both time and material. It will pay you to investigate the manufacturing economies Keller "Wire-Wrap" tools can bring.

- Uniform connections . . . power tool cannot be manipulated to vary results.
- Material savings . . . no solder, screws, clips required.
- Faster . . . less time required to make connection, reduced inspection time.
- Less rejects . . . stable connections maintain contact under stresses of assembly, installation, shipment and operation.
- Easy to use . . . short operator learning period to attain proficiency.

Write for Bulletin

See this NEW IDEA

. . . and its application to automation of radio and television wiring at the

I.R.E. SHOW

New York Coliseum
March 18-21
Booth 4126



ENGINEERING FORESIGHT—PROVED ON THE JOB
IN CONSTRUCTION, MINING, PETROLEUM AND GENERAL INDUSTRY

GARDNER - DENVER

KELLER TOOL division, Grand Haven, Michigan

**True Hermetic Sealing
assures Maximum Stability**

in **AMPERITE** **RELAYS and REGULATORS**

Simplest • Most Compact • Most Economical



Thermostatic **DELAY RELAYS** **2 to 180 Seconds**

- Actuated by a heater, they operate on A.C., D.C., or Pulsating Current.
- Hermetically sealed. Not affected by altitude, moisture, or other climate changes.
- SPST only — normally open or normally closed.

Amperite Thermostatic Delay Relays are compensated for ambient temperature changes from -55° to $+70^{\circ}$ C. Heaters consume approximately 2 W. and may be operated continuously. The units are most compact, rugged, explosion-proof, long-lived, and — inexpensive!

TYPES: Standard Radio Octal, and 9-Pin Miniature

Also — Amperite Differential Relays: Used for automatic overload, under-voltage or under-current protection.

**PROBLEM? Send for
Bulletin No. TR-81**

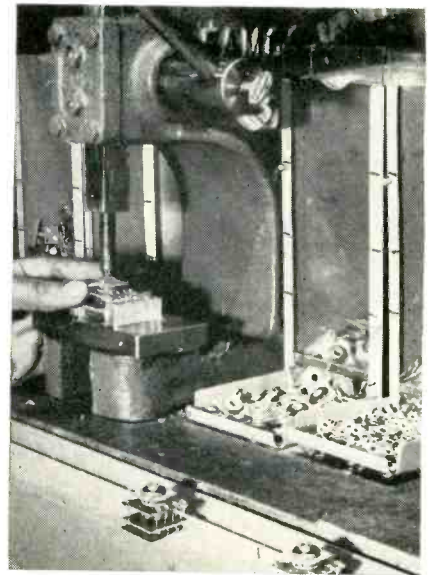

Arbor press setup on work center for swaging rectifiers to coil assembly

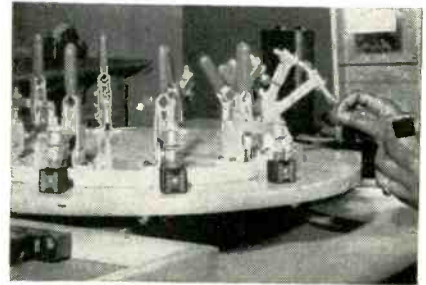

Last step in assembly involves applying bonding cement to edges of halves of plastic cases, putting package together over coil assembly, then placing under spring clamp on turntable for drying under pressure

BALLAST REGULATORS

Amperite Regulators are designed to keep the current in a circuit automatically regulated at a definite value (for example, 0.5 amp.) ... For currents of 60 ma. to 5 amps. Operate on A.C., D.C., Pulsating Current.

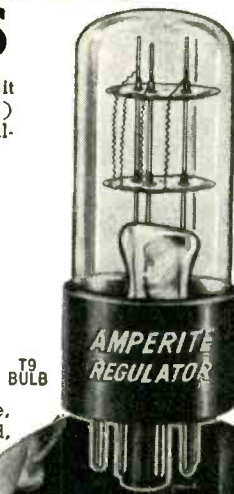
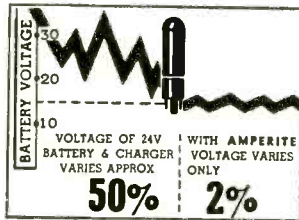
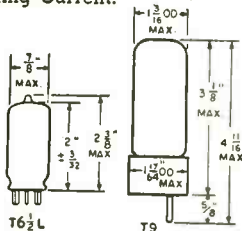

Hermetically sealed, they are not affected by changes in altitude, ambient temperature (-55° to $+90^{\circ}$ C.), or humidity ... Rugged, light, compact, most inexpensive.

Write for 4-page Technical Bulletin No. AB-51

AMPERITE CO., Inc.

561 Broadway, New York 12, N. Y.

Telephone: CAnal 6-1446

In Canada: Atlas Radio Corp., Ltd.
50 Wingold Ave., Toronto 10, Ontario.

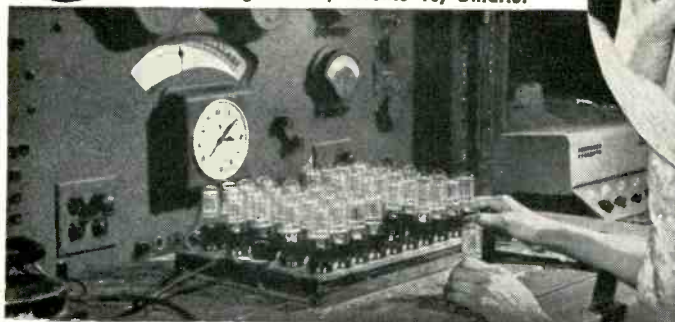

Individual inspection and double-checking assures top quality of Amperite products.

jigs are returned to the first position on the lower portion of the conveyor belt.

► **Testing**—In-line testing for continuity and dynamic operating properties follows the soldering operation. This is conveniently done since the assemblies will plug into a test socket made for the purpose. Salvageable rejects are routed off the line to a repair line and then back again for completion.

For moistureproofing, the assemblies are dipped in a special wax compound and then hung diagonally to drain. The setting process is rapid enough to allow flow through the line.

► **Final Assembly**—Pretested rectifiers are mounted and riveted onto the assembly. As the rectifiers are somewhat pressure-sensitive, some operator skill is

FORGING AHEAD TO NEW TERRITORIES

"Safety Margin"*

electrolytic capacitors

... FOR MINIATURIZED, PRINTED AND TRANSISTORIZED CIRCUITS



STANDARD TWIST PRONG MOUNTING STYLE - EX

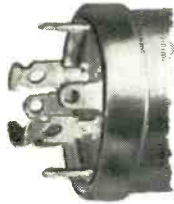

PRINTED CIRCUIT MOUNTING STYLE - EZ

NEW ASTRON ELECTROLYTICS

Pioneer efforts in the manufacturing of capacitors over the past years have raised ASTRON to the position of being "tall in the saddle" . . . a leader in subminiature, metallized paper, and molded plastic paper tubular designs.

And now ASTRON looks ahead to the new territories of miniaturized, printed and transistorized circuitry in such applications as car, portable, pocket-type and similar receivers.

New ASTRON Electrolytics have been specially designed to meet their exacting requirements which include small size, extremely low leakage, and long "idling" or shelf life. These rugged, hermetically sealed capacitors supply dependable performance over wide temperature ranges . . . have the ability to withstand vibration and shock.

ASTRON Electrolytics Style EX and EZ are manufactured with strict production controls and only the finest of materials—specially anodized, 99.99% pure aluminum foil, scientifically compounded electrolytic formulas, surgically clean assembly methods . . . "Safety Margin"* protective construction. They are available in a wide selection of capacitance and voltage ratings.

Send today for further technical information. *Please describe your application; it helps us to offer proper assistance to you . . .* when special conditions require, we will design a prototype to meet your specifications.

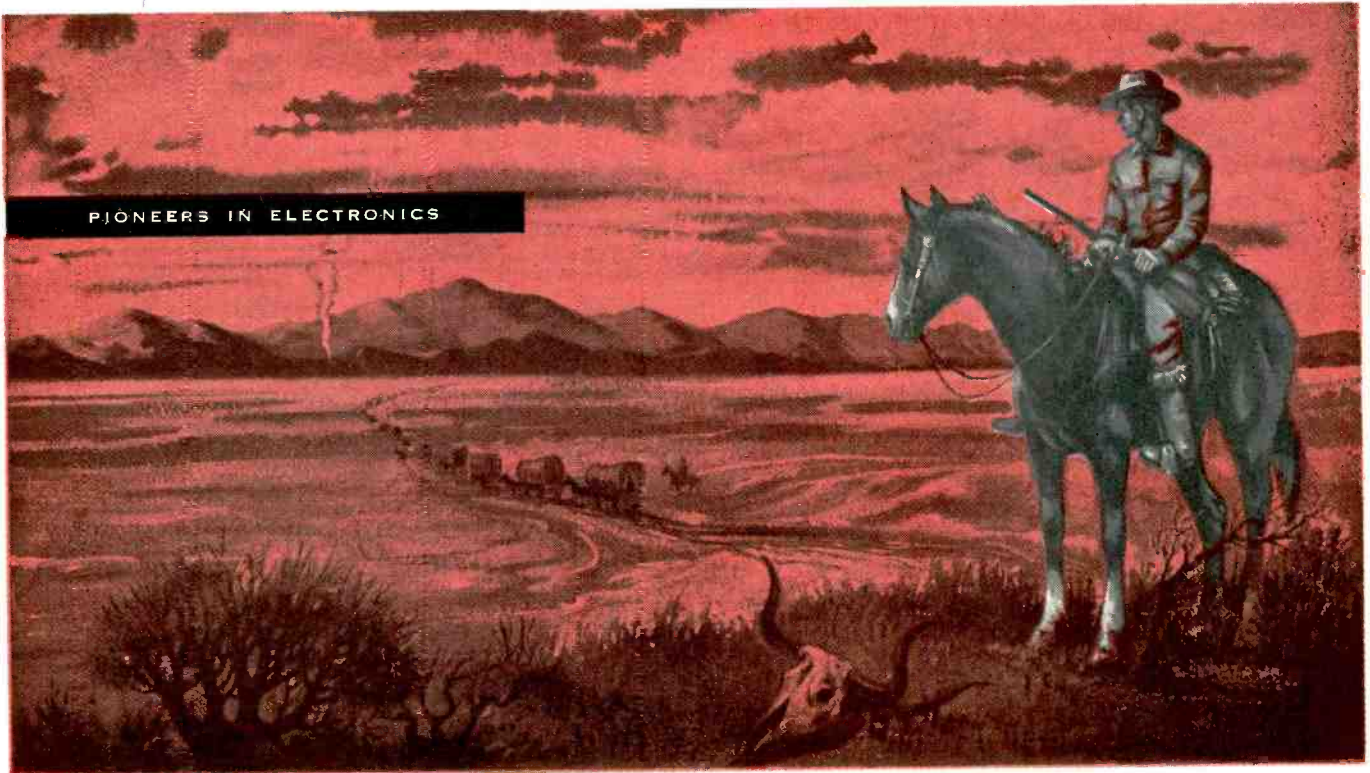

PIONEERS IN ELECTRONICS

ASTRON CORPORATION

255 GRANT AVENUE

EAST NEWARK, N. J.

Export Division: Roche International Corp., 13 East 40th St., N. Y., N. Y.

In Canada: Charles W. Poin-ton, 6 Alcina Ave., Toronto, Ontario



A wholly-owned subsidiary of ASTRON CORPORATION
PECKVILLE, PENNSYLVANIA

*Trade-Mark

Be Sure to see us at Booth No. 2927 at the IRE Show

A New Broad Band *Kearfott*



Model W177-2C-1

FERRITE ISOLATOR for Laboratory Test Bench Use

Use this Ferrite Isolator in your microwave setup for maximum frequency stability.

Typical Performance Curves

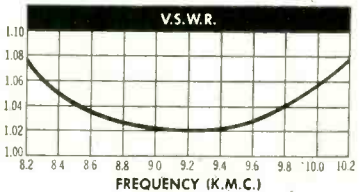
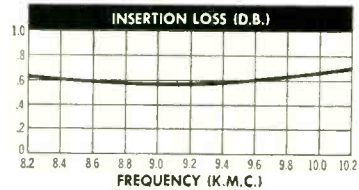
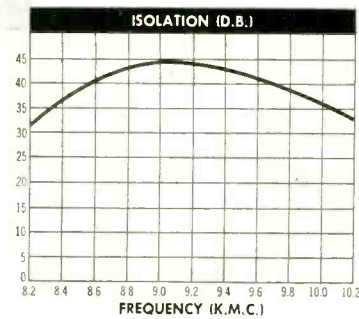

CHECK THESE FEATURES:

Broad Band—Usable from 8.2 to 10.2 KMC

High Isolation—A minimum of 25 db over the band

Insertion Loss—Less than 1 db

Small & Compact—Only 2½ inches long—weighs only 1½ lbs.

Flanges—Cover type. Mates with UG39/U flanges. Will absorb up to 10 watts reflected power

Price—\$135.00 each f.o.b., Van Nuys, Calif.

Delivery—From stock

Order—Model W177-2C-1

For custom-made isolators for specific radar & microwave application, you can depend on the skill of the Kearfott organization.

Kearfott, Western Division, has complete facilities for waveguide production, with qualified experts to assist in solving your problems. Let us help you.

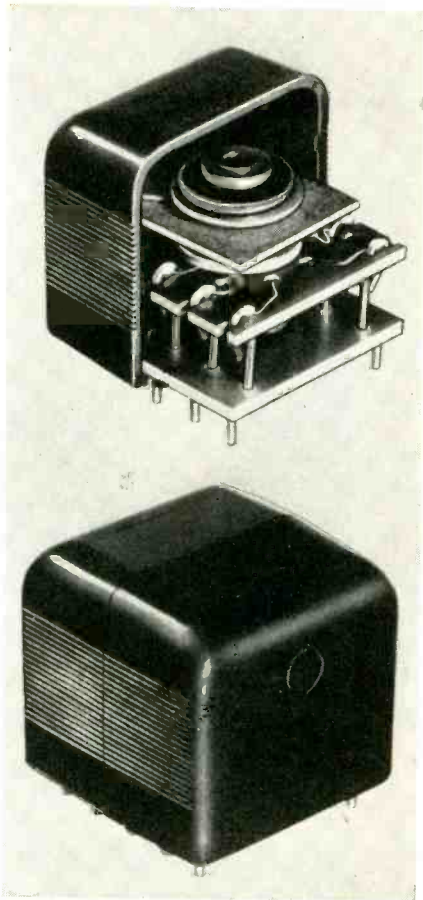

Finished coil assembly before and after sealing in plastic case

required in judging swaging pressure. The coil assembly itself receives no pressure from the swaging tool as it is mechanically isolated by the center mounting stud. Compactness and efficiency is afforded here by Alden Systems work positions and parts dispensers. All positions on the main assembly line involve finger motions of only a few inches.

At the final position, an operator inserts the assembly into plastic case-halves and cements them together. A turntable using toggle clamps gives a 5 to 10-minute drying cycle under pressure.

Welder Locks Turns on Tape Core Winder

MULTIPLE-CORE winders used by Magnetics, Inc. of Butler, Pa. allow winding of tape on five or more ceramic cores in one loading. The cores are placed on the shaft and a nut is hand-tightened to lock them in place. The magnetic tape core is

Kearfott COMPANY, INC.
LITTLE FALLS, NEW JERSEY
WESTERN DIVISION
MICROWAVE DEPARTMENT
14844 OXNARD ST. - VAN NUYS, CALIF.

SALES OFFICES

Eastern Office: 1378 Main Ave. Clifton, N.J.	Midwest Office: 188 W. Randolph St. Chicago, Ill.	South Central Office: 6115 Denton Drive Dallas, Texas	Western Area Office: 253 Vinedo Ave. Pasadena, Calif.
--	---	---	---



For detailed information, ask for bulletins on new Ferrite Isolators and Radar Test sets.

Now...



One Integrated Source

for High Temperature • Vacuum-Tight
Mass-Spectrometer Tested

Ceramic-to-Metal Seals



NOW AVAILABLE—A standard line of Alite high voltage bushings. Sizes 2" or 2 3/4" diameters; 2 to 8 flutes; 1, 2 or 3 terminal studs; optional stud lengths and thread sizes.

With the addition of complete facilities for high temperature metalizing and bonding, our Alite Division offers engineers and designers a single dependable source for ceramic-metal assemblies. Now you can plan for superior quality and highest precision in electronic insulating components employing ALITE—the sintered aluminum oxide especially formulated for critical electronic applications.

Alite possesses a unique combination of properties which makes it ideal for use as the insulating body in ruggedized, high performance hermetic seals and bushings. It has exceptionally high mechanical strength and thermal shock resistance, permitting operation over wide extremes of temperature, pressure, humidity and vibration. Alite maintains its high dielectric strength and excellent low-loss characteristics at micro-wave frequencies and elevated temperatures.

Alite seals are operative at extremely high temperatures, being limited only by the melting point of the bond metal used. When Alite is metalized and bonded, using high temperature brazing metals such as pure silver, copper, gold, or their alloys, the result is a vacuum-tight Alite-to-metal seal that meets the most exacting requirements.

Get in touch with us if you have component problems involving ceramic-to-metal seals.

Our technical service is ready to handle your toughest assignments.

A Few Outstanding Properties of ALITE

Tensile Strength	26,500 psi
Compressive Strength	285,000 psi
Dielectric Constant @ 10,000 mc	8.4
Dielectric Strength (volts per mil).....	250
Power Factor @ 10,000 mc.....	0.0008
Loss Factor @ 10,000 mc.....	0.0067

Visit ALITE at the IRE Show—Booth 4236



U. S. STONEWARE

AKRON 9, OHIO

NEW YORK OFFICE: 60 EAST 42nd ST.

480-E

NEW Development!

HICKOK

250° Arc

LONG SCALE METERS

Save Valuable Panel Space

The scale in these new instruments is 2½ times as long as conventional meters. A 3½" HICKOK 250° meter has a scale length equal to a conventional 6" instrument.

These exclusive panel style 250° meters fit a smaller space though still provide easier, more accurate readings.

Available in all popular AC or DC ranges. Square, semi-flush or round flush cases. 2½" thru 5½" sizes.

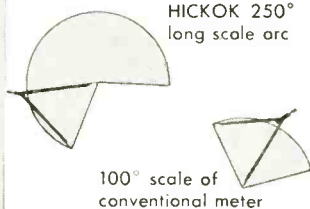
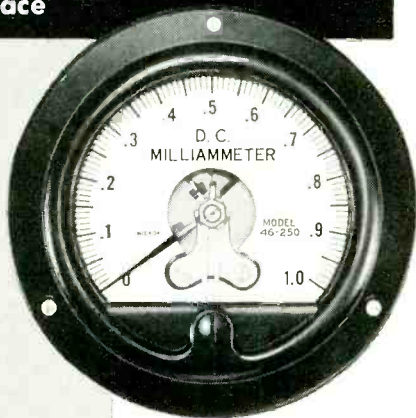

UNIFORM SCALE
Evenly Spaced Scale Divisions

RUGGEDIZED and SEALED

AC rectifier or DC types

The highly efficient HICKOK shock mount construction permits pointer and scale divisions to be easily read when meter is under vibration. The DC movement is a precise and rugged internal pivot type. The AC movement is of the iron vane principle with unusually efficient magnetic damping for ruggedized purposes. Case is permanently sealed at the factory, however, may be opened and resealed.

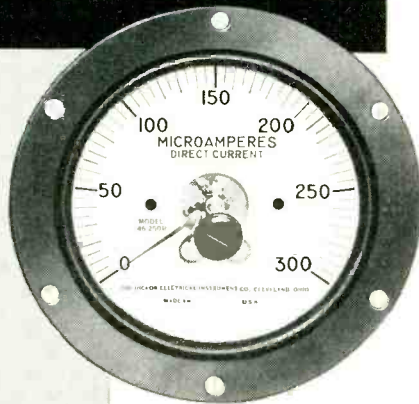

These instruments meet military specifications and are in volume production. Your inquiry is invited. Kindly list details of your requirements or request Catalog No. 33.

THE HICKOK ELECTRICAL INSTRUMENT CO.

10527 DuPont Avenue • Cleveland 8, Ohio

then wound on each bobbin by guiding the tape with the left hand while turning the shaft with the right hand. A disk and handle arrangement on the other end of the shaft facilitates rotation. A pin on the disk, next to the handle,

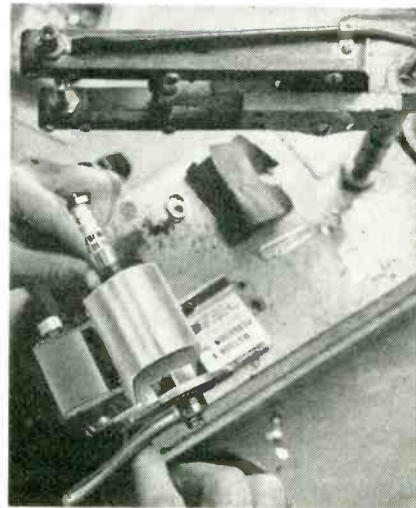

Straight arm pushed around by forefinger rotates winding shaft while left hand guides tape. Pivoted welder is swung over each finished core in turn

flicks the counter arm once in each revolution to give a turns count.

When the proper count is reached for a core a pivoted spot welder head is swung over the core to tack the last turn of tape. The welder timing is set to fuse only the outer two turns together. The winding process is then repeated for each other core.

Miniature Soldering Iron

ESPECIALLY SUITABLE for soldering to transistors and diodes, a new miniature low-voltage soldering iron greatly expedites production

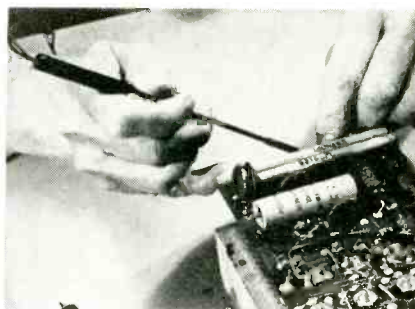

Pin-point soldering iron weighing no more than ordinary lead pencil simplifies production of etched wiring circuits for transistorized Geiger counters in plant of UM & F Mfg. Corp., North Hollywood, Calif.



high speed transistors for computer switching circuits

Sprague 2N240 transistors with their fast response time—in the millimicrosecond range—give reliable operation in switching circuits up to 20 megacycles. The ideal electrical characteristics of these surface barrier transistors permit direct coupling for faster operation than any alloy junction type.

And the 2N240 gives you:

- low saturation resistance
- low saturation voltage
- extremely fast rise and fall time
- absolute hermetic seal
- availability

Among these features, the most important to you may well be availability. Sprague is manufacturing 2N240 transistors NOW in production volumes. You can answer today's transistor needs *today* by specifying Sprague surface barrier transistors!

Write for complete data sheets on Sprague 2N240 germanium surface barrier transistors and on Sprague general purpose high-frequency surface barrier types SB 101 and SB 102. All are available on letterhead request to the Technical Literature Section, Sprague Electric Co., 35 Marshall Street, North Adams, Mass.



CAPACITORS • RESISTORS • MAGNETIC COMPONENTS
TRANSISTORS • INTERFERENCE FILTERS • HIGH TEMPERATURE
MAGNET WIRE • PULSE NETWORKS • PRINTED CIRCUITS

SEE US AT THE I.R.E. SHOW—BOOTHS 2416-18-20-22

SPRAGUE[®]
the trademark of reliability

TRANSFORMERS for your SPECIAL REQUIREMENTS

TWO NEW



SPECIAL UNITS

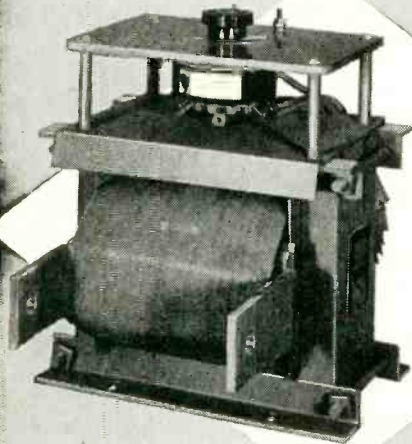

Resistance Welding Transformer with eight point tap-changing switch on primary winding. Used for a varying secondary current output. Unit shown is 3 KVA. Units are available from .5 to 50 KVA.

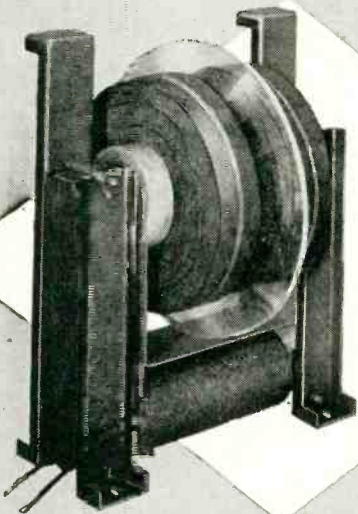

High Voltage Plate Transformer for use under oil with other equipment in same tank. Unit shown is 50 KV center tap grounded, 4 KVA and high impedance. Note plastic insulation shield between coils. This unit available from 100 VA to 100 KVA.

For any special transformer, you will get the highest quality, the fastest delivery, the most reasonable cost and the highest efficiency from Nothelfer Winding Laboratories. Their production is geared to the manufacture of special transformers, chokes and reactors.



Nothelfer

WINDING LABORATORIES, Inc.

P. O. Box 455, Dept. 102, Trenton, N. J.

Write for complete information, specifying your particular requirements.

wiring of all fine subassemblies. The pencil-size precision tool, weighing only $\frac{1}{4}$ ounce, supplies rapid pin-point heat in 30 seconds from interchangeable nickel-plated tips as fine as $\frac{1}{16}$ inch in diameter. The light weight permits continuous use all day without hand fatigue.

The iron is available from Oryx Company, 9015 Wilshire Blvd., Beverly Hills, Calif. in models with voltage ratings from 6 to 50 volts and wattage ratings from 6 to 12 watts.

Machine Inserts Tubes in Cartons

AN AUTOMATIC tube-packaging machine in the Elmira, N. Y. plant of Westinghouse Electric Corp. automatically opens a carton, inserts a tube, closes the carton and prints the tube type designation on the end of the carton. The individually packaged tube is then delivered by conveyor to the packing operator.

After production and initial test, the receiving tubes are stored in cell partitions in open trays like

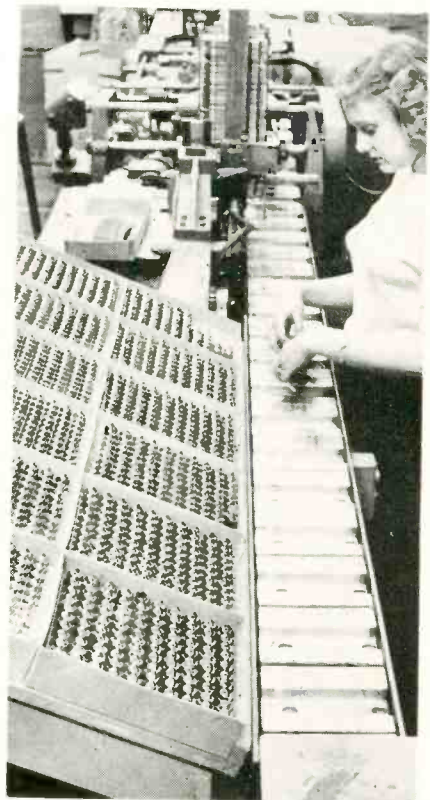

Packaging starts here. Operator places tubes in built-in channels on conveyor of machine

Now...an accomplishment so far reaching it will change the sights of all rectifier users

RADIO RECEPTOR'S improved new vacuum process

*** PETTI-SEL**
** High Current Density*
Industrial type SELENIUM RECTIFIERS

Developed by the famous Siemens Organization of West Germany and now manufactured by Radio Receptor Co. in the U. S. A.

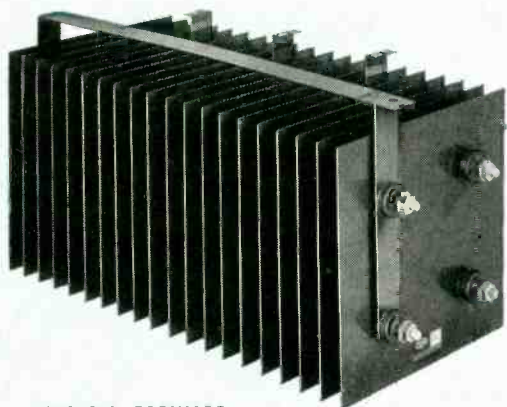

Estimated life 100,000 hours

Much smaller cell sizes than conventional units of the same ratings

Lower forward voltage drop

Suitable for high temperature applications

TYPICAL FORWARD CHARACTERISTICS

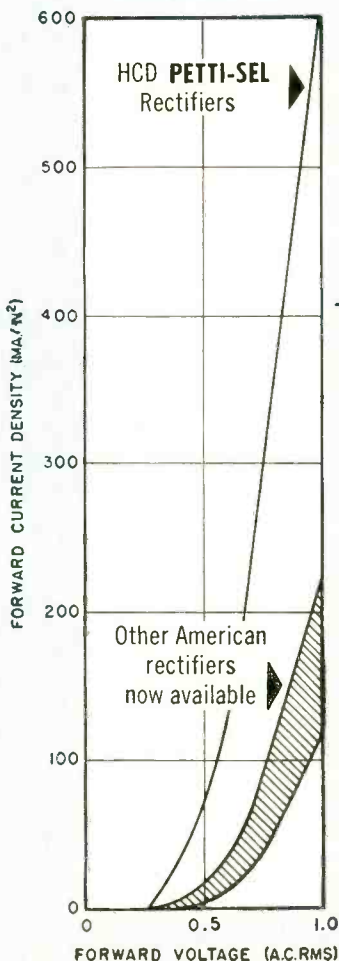

Far smaller in size than other rectifiers of the same current ratings, the new Radio Receptor HCD Petti-Sel units are manufactured under laboratory controlled conditions with fully automatic machinery, assuring new standards of product uniformity.

Field experience extending over several years with these rectifiers indicates an estimated life of 100,000 hours. This is largely attributable to the special process requiring no artificial barrier layer. Low forward voltage drop and low aging rate make the new Petti-Sel Rectifiers applicable to magnetic amplifiers and other control applications.

TYPICAL AGING CHARACTERISTIC

Cell size 4" x 4", single phase bridge (4-5-1-B) operated at 130 volts AC input, 8 amperes DC output current, resistive load, 35° C ambient temperature.

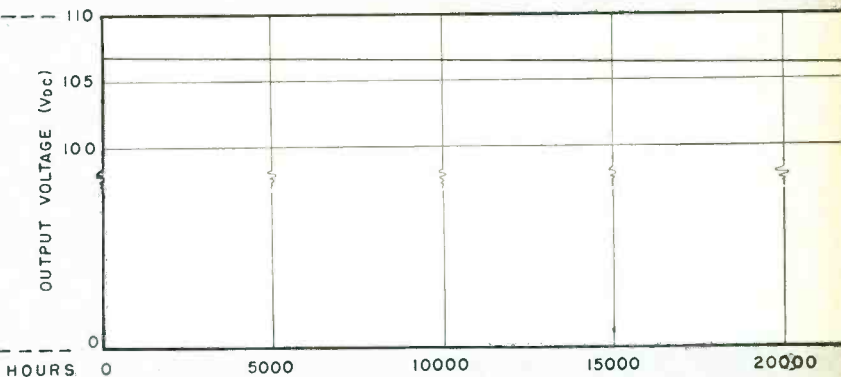

Watch for further announcements of unique developments on these history-making rectifiers. If you would like our new bulletin as soon as it is available, write today to Section E-3R.

Semiconductor Division
RADIO RECEPTOR COMPANY, INC.

Radio and Electronic Products Since 1922

240 Wythe Avenue, Brooklyn 11, N. Y. • Evergreen 8-6000

Radio Receptor Products for Industry and Government: Selenium Rectifiers • Germanium Diodes
 Thermatron Dielectric Heating Generators & Presses • Communications, Radar & Navigation Equipment

DOUBLE INSULATION!

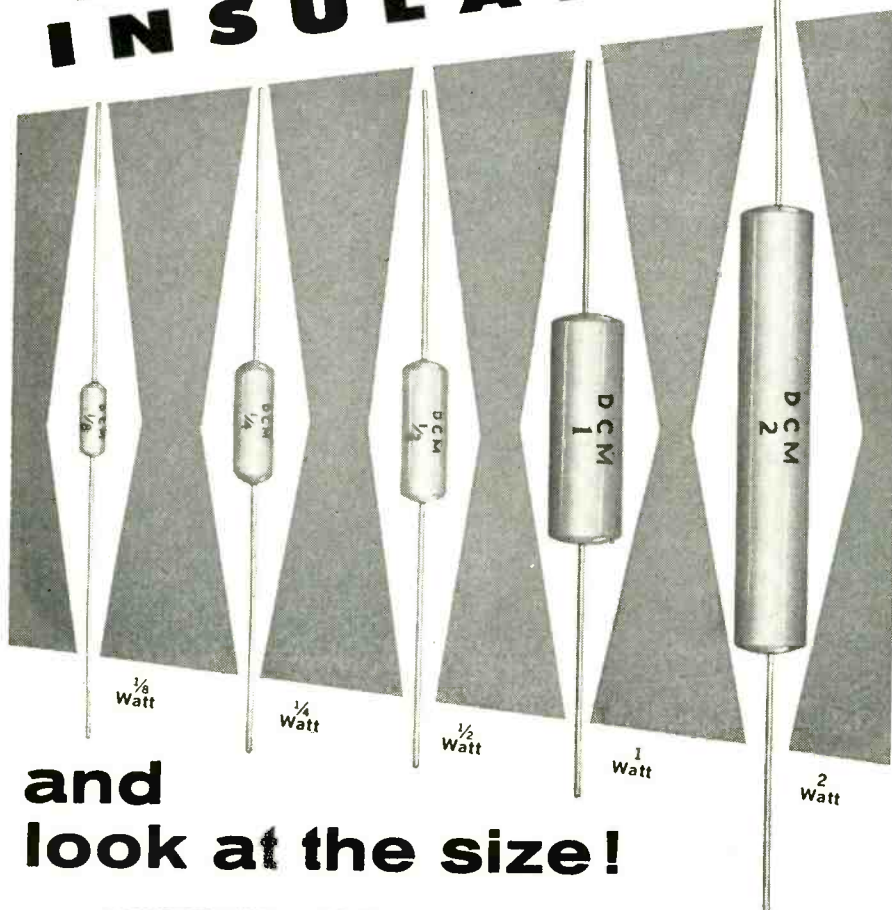

and
look at the size!

ELECTRA MOLDED DEPOSITED CARBON (PLASTIC ENCAPSULATED) RESISTORS

Extreme precision, of course. But, in Electra's molded deposited carbon resistors you get far more in addition. They're doubly insulated to give you extra mechanical protection, longer load life, better electrical insulation, greater resistance to moisture and higher operating temperatures. Get all the facts. Electra also offers you a complete line of standard and hermetically sealed deposited carbon resistors.

Just write, wire or call

Electra MANUFACTURING CO.

4051 Broadway Westport 1-6864 Kansas City, Missouri

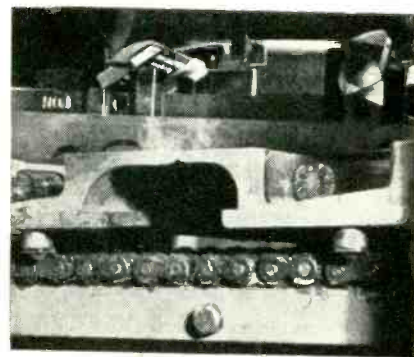

After cartons are delivered to conveyor, machine automatically opens carton prior to tube insertion

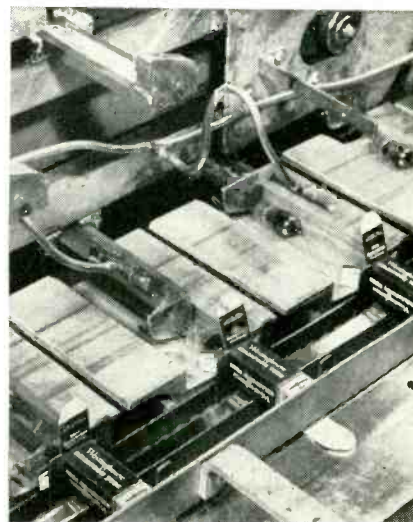

Tube insertion, shown here with slide bar removed from unit. Tube is conveyed in rigid channels while being pushed into open carton. Air blows into channel to keep tube from twisting or jamming in box during insertion

egg crates. When an order comes in, each tube is electrically tested and mechanically inspected in an area adjacent to the packaging machine. The tube is next branded with the manufacturer's code, customer's brand and date code. The pre-shipment tested tube is then moved in the bulk handling trays directly to the input end of the packaging machine. This procedure reduces excess handling and minimizes the chance that a defective tube can reach the customer.

► **Loading**—An operator removes the tubes from their cells in the tray and places them in buckets built into the packaging machine conveyor. Simultaneously, the cartons are hopper-fed to another packaging-machine conveyor belt traveling parallel to the tube conveyor line. The packaging machine opens the cartons automatically in

Constantin GLASS-TO-METAL SEALS



special sealing techniques

Insure quality

The measure of any glass-to-metal seal's quality is its ability to withstand extremes of temperature, shock and vibration. And Constantin's special sealing techniques insure quality seal performance in the most difficult applications.

Inspection and quality control are of prime importance at Constantin, too. Six, separate check points are maintained for the critical evaluation of each and every seal that comes down the production line.

Experience counts . . . and Constantin's long experience in the design and fabrication of both standard and specialized all-in-one assemblies, end seals, transistor mounts, unit headers, crystal covers, and connectors has set the norm for quality in the glass-to-metal industry.

This versatility of manufacture and experience can be yours.

Write today for more information.



L. L. Constantin & Co.

**MANUFACTURING
ENGINEERS**

Route 46, Lodi, N. J. • 187 Sargeant Ave., Clifton, N. J.

TRANSISTOR MOUNTS • COMPRESSION HEADERS • CRYSTAL BASES • CONNECTORS • MINIATURIZATION

SINGLE TERMINALS • END SEALS

SEE US AT BOOTHS #3801-3803, I.R.E. SHOW

Want more information? Use post card on last page.

Molded RF Choke Coils Complete & Standardized Series

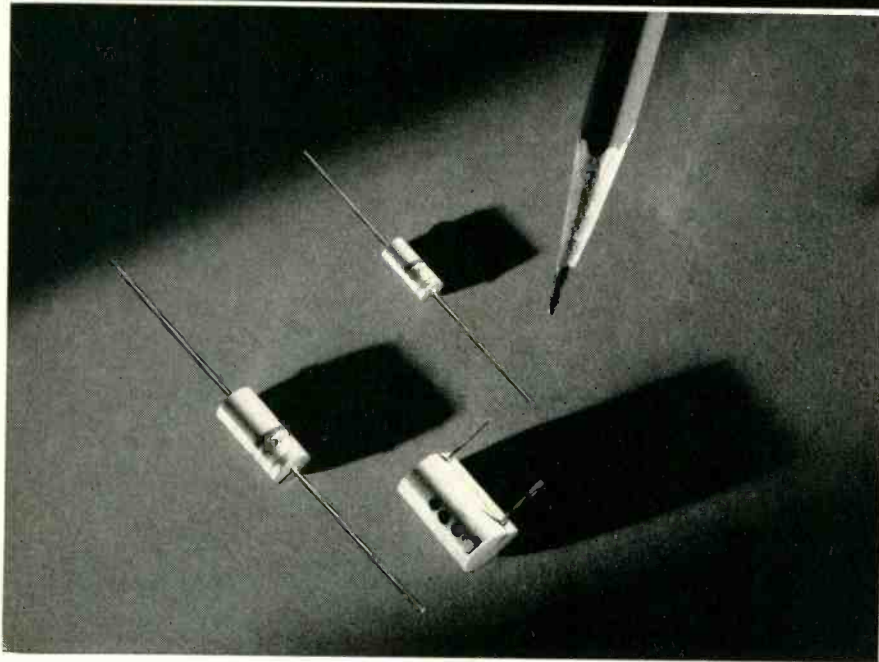

150 RF COILS IN 6 SERIES STANDARDIZED TO SIMPLIFY YOUR ENGINEERING AND PRODUCTION PROBLEMS

- Inductance values range from .15 μh to 10,000 μh . Each coil is completely defined by physical size and related electrical parameters.
- A miniature series as small as a half-watt resistor.
- Hermetically encapsulated in molded alkyd plastic suitable for operation to 105°C.
- Conform to MIL-C-15305A.
- Quality controlled to 0.65 AQL on all shipments.
- Available for prompt delivery from stock and current production.
- Substantial savings possible by your use of standardized coils.
- Complete coil specifications in catalog form available upon request.
- Custom RF Coils developed and produced to solve your particular problems.

For full information write Dept. E-1



DELEVAN
Electronics
CORPORATION
EAST AURORA, NEW YORK

PRODUCTION TECHNIQUES

(continued)

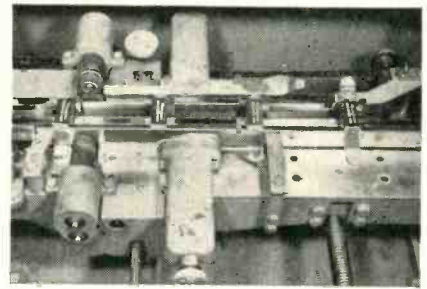

Closing of carton begins at this step of operation. Flaps are folded and tucked into carton

preparation for loading. The tube conveyor lines up a tube with an empty carton and the machine feeds the tube into the waiting carton. Next the flaps are automatically closed and locked on both ends of the carton.

At this stage the tube type designation is imprinted on one end of the carton. The conveyor line then moves the cartons to packers for loading into 5-pack sleeves and shipping containers.

The machine has several snap-action switches to prevent malfunctioning. It is comparatively easy to change the marking stamp to accommodate a production run of another type of tube.

An interlocking device called a no-carton detector is adjusted to stop the machine if one carton is missing or improperly positioned for insertion of the tube. A similar device reacts to missing tubes. The machine has been designed to handle tubes gently, without shock

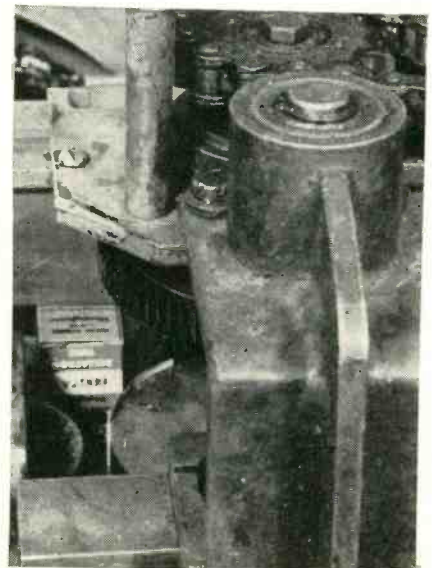

After flaps are tucked in, printer applies tube type designation to carton in space provided

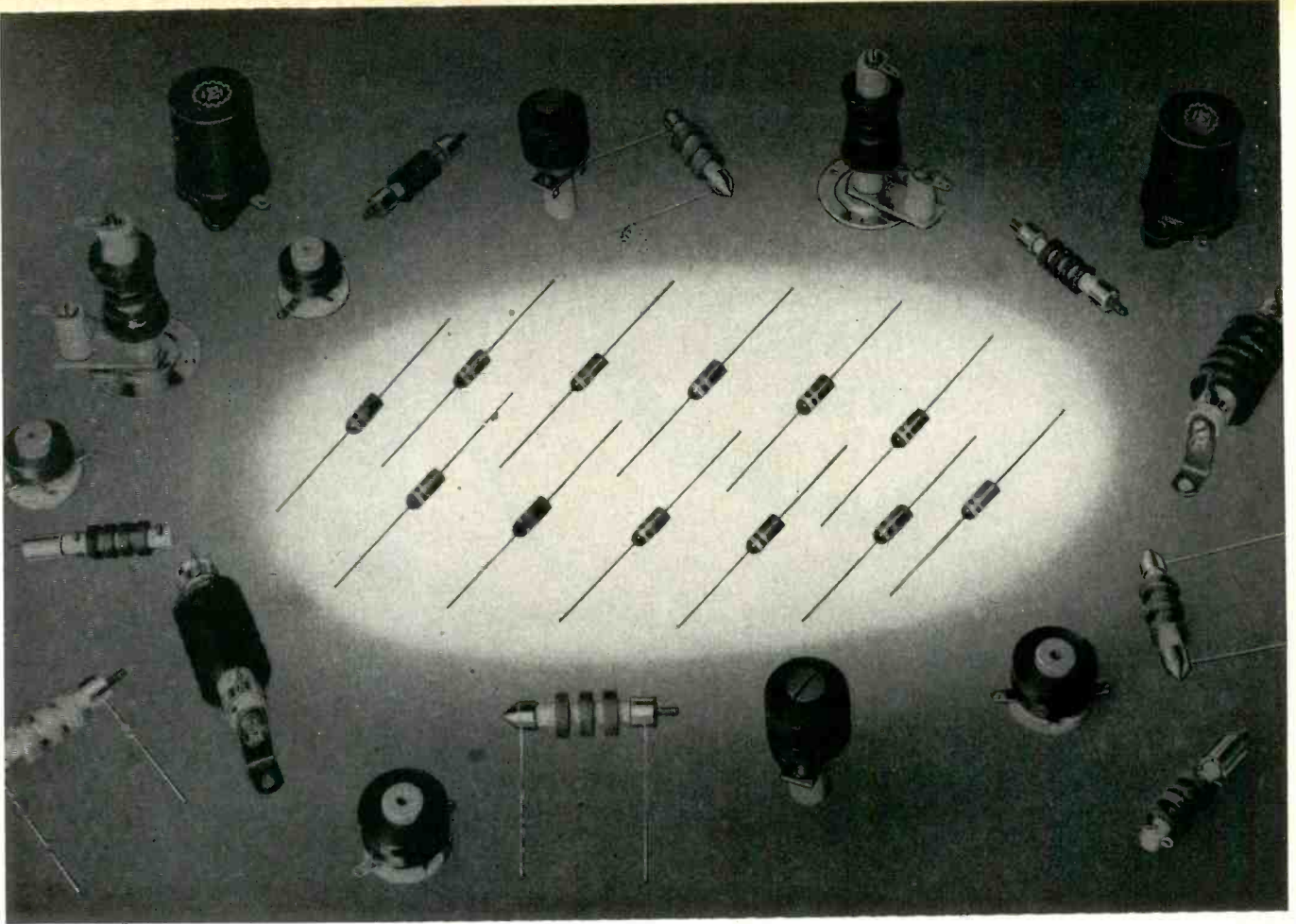

Encapsulated Inductances

Millen **DESIGNED** for APPLICATION encapsulated coils provide another advance in the r-f inductor field. Modern application requires miniature, heat and cold resistant, hermetically sealed, and abrasion resistant r-f inductor assemblies. The James Millen Manufacturing Company has pioneered many advances in the r-f inductor field, including the now standard 4 pi r-f choke, the axial lead r-f choke, and the miniature r-f choke. Developments have now made possible another advance, the No. 34301 and No. 1301 encapsulated inductors—hermetically sealed—miniature size. Ambient temperature minus 55 degrees to plus 100 degrees C.

NO. J301 MINIATURE ENCAPSULATED INDUCTANCES

DESIGNED for APPLICATION miniature inductances are: extremely small (see table at right)—hermetically sealed—wound on axial lead Carbonyl cores—color coded. Coils are available in RETMA standard values plus 25, 50, 150, 250, 350, 500, and 2500 microhenries. Coils are three layer solenoids up to 350 microhenries. From 360 to 2500 microhenries coils are pi-wound. Current rating 50 to 600 milliamperes depending on coil size. Inductance \pm 5%. Special coils on order.

NO. 1301 STANDARD ENCAPSULATED INDUCTANCES

Encapsulated **DESIGNED** for APPLICATION axial lead phenolic form r-f inductances. Hermetically sealed—heat resistant—abrasion proof—color coded. 1 to 350 microhenries available in RETMA standard values plus 25, 50, 150, 250, and 350 microhenries. Inductance \pm 5%. Values available in same progression as J301 coils listed in the table at the right. Solenoid winding for 1 to 15 microhenries. Universal pi winding from 20 microhenries to 350 microhenries. Current rating 250 to 1500 milliamperes, depending on coil size. Ambient temperature range—minus 55 degrees to plus 100 degrees Centigrade. Size: $\frac{3}{8}$ inches diameter \times $\frac{1}{8}$ inches long. Special coils on order.

COIL NUMBER	INDUCTANCE MICROHENRIES	DIAMETER INCHES	LENGTH INCHES
J301-25	25	$\frac{3}{16}$	$\frac{1}{16}$
J301-33	33	$\frac{3}{16}$	$\frac{1}{16}$
J301-47	47	$\frac{3}{16}$	$\frac{1}{16}$
J301-50	50	$\frac{3}{16}$	$\frac{1}{16}$
J301-82	82	$\frac{3}{16}$	$\frac{1}{16}$
J301-100	100	$\frac{3}{16}$	$\frac{1}{16}$
J301-120	120	$\frac{3}{16}$	$\frac{1}{16}$
J301-150	150	$\frac{3}{16}$	$\frac{1}{16}$
J301-200	200	$\frac{3}{16}$	$\frac{1}{16}$
J301-220	220	$\frac{3}{16}$	$\frac{1}{16}$
J301-250	250	$\frac{3}{16}$	$\frac{1}{16}$
J301-300	300	$\frac{3}{16}$	$\frac{1}{16}$
J301-330	330	$\frac{3}{16}$	$\frac{1}{16}$
J301-350	350	$\frac{3}{16}$	$\frac{1}{16}$
J301-360	360	$\frac{7}{32}$	$\frac{3}{16}$
J301-390	390	$\frac{7}{32}$	$\frac{3}{16}$
J301-430	430	$\frac{7}{32}$	$\frac{3}{16}$
J301-470	470	$\frac{1}{4}$	$\frac{1}{16}$
J301-500	500	$\frac{1}{4}$	$\frac{1}{16}$
J301-510	510	$\frac{1}{4}$	$\frac{1}{16}$
J301-560	560	$\frac{1}{4}$	$\frac{1}{16}$
J301-620	620	$\frac{1}{4}$	$\frac{1}{16}$
J301-680	680	$\frac{7}{32}$	$\frac{3}{16}$
J301-750	750	$\frac{7}{32}$	$\frac{3}{16}$
J301-820	820	$\frac{7}{32}$	$\frac{3}{16}$
J301-910	910	$\frac{7}{32}$	$\frac{3}{16}$
J301-1000	1000	$\frac{7}{32}$	$\frac{3}{16}$
J301-1200	1200	$\frac{3}{16}$	$\frac{13}{16}$
J301-1300	1300	$\frac{3}{16}$	$\frac{13}{16}$
J301-1500	1500	$\frac{3}{16}$	$\frac{13}{16}$
J301-1800	1800	$\frac{3}{16}$	$\frac{13}{16}$
J301-2000	2000	$\frac{3}{16}$	$\frac{7}{8}$
J301-2200	2200	$\frac{3}{16}$	$\frac{7}{8}$
J301-2400	2400	$\frac{3}{16}$	$\frac{7}{8}$
J301-2500	2500	$\frac{3}{16}$	$\frac{7}{8}$

JAMES MILLEN



MFG. CO., INC.

MAIN OFFICE

AND FACTORY

MALDEN, MASSACHUSETTS, U S. A.



- OUTPUT UP TO 5 VOLTS WITHOUT AMPLIFICATION
- ACCURATE UNDER 25G TO 2,000 CPS VIBRATION
- AVAILABLE IN VARIOUS RANGES FROM -300°F. TO 1500°F.
- RESISTANCE CHANGE OF 100 OHMS OVER SPECIFIED RANGE

Trans-Sonics Type 1300 Bulb Temperature Pickups are precision high-speed resistance thermometers with a platinum resistance winding as the sensing element. Each Type 1300 Bulb Temperature Pickup is individually calibrated and supplied with its own calibration sheet. The temperature interval over which the 100 ohm resistance change will occur may be as low as 100°F. These Pickups are designed to withstand pressures up to 3,000 psia. When specified they can be furnished for installations in *corrosive* liquids or gases. Their leads can be exposed to temperatures up to 600°F. and may be detached from the instrument proper for shortening or easy replacement. Write for Bulletin 1300 to Trans-Sonics, Inc., Dept. 5.

* Reg. Trademark

SPECIFICATIONS

CASE CONSTRUCTION: Stainless Steel
ACCURACY: ±1% of full scale range
PRECISION: ±0.2% of full scale range
MAXIMUM CONTINUOUS CURRENT: 20 ma rms (averaged over 1 second)
TIME CONSTANT: Less than 2.5 seconds in agitated water
ENVIRONMENTAL OPERATION CONDITIONS
PRESSURE: 3000 psia (at room temperature)
VIBRATION: 1" double amplitude, 0 to 22 cps ± 25g, 22 to 2000 cps
SHOCK: 60 g in any direction, per para. 4.15.1 of MIL-E-5272A (10 milliseconds shock)

For Transducers, See Trans-Sonics

Trans-Sonics, Inc.

P. O. BOX 328

LEXINGTON 73, MASSACHUSETTS



Tubes in single cartons are placed in the handy five-pack sleeve, and sleeves in turn are packed in standard shipping cartons

and vibration which might cause internal breakage.

► **Output**—The new machine is capable of packaging 200 receiving tubes per minute, or 96,000 tubes in an 8-hour period. By way of contrast, an operator can package only 3,000 tubes in an 8-hour day.

Leak Detector for Hermetic Seals

BY B. W. SCHUMACHER
Research Fellow
Ontario Research Foundation
Toronto, Canada

RAPID NONDESTRUCTIVE testing of hermetically sealed components for leakage through seals is now being achieved with a carrousel-like pumping turntable setup having a sensitivity comparable to that of the mass spectrometer. No special test gas is required, however.

Though designed for rapid 100-percent testing at the end of a production line, the apparatus serves equally well for sampling inspection and for following changes that occur in a component during storage or when subjected to various atmospheric conditions or acceptance tests. The latter tests served to reveal correlations between shelf-life leaks and certain electrical failures arising during storage.

Where the units are filled with helium gas, the mass spectrometer type of leak detector may be used

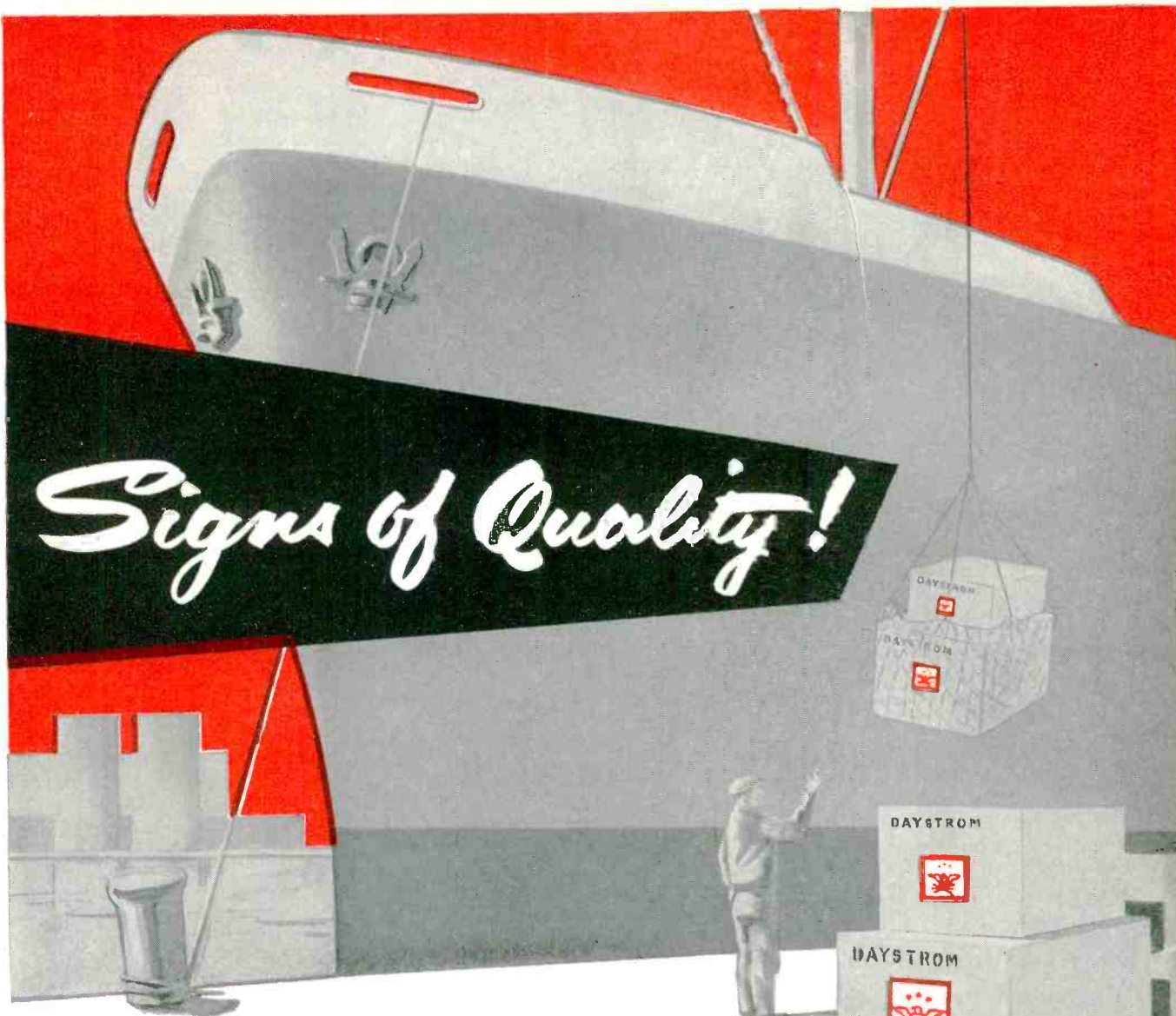

You can't buy this seal of approval . . . you've got to earn it. You've got to be able to produce quality. Daystrom Instrument is doing it every day. Daystrom is proud of the quality record it has established in the industry . . . and with all branches of the armed services. Fire Control Systems, Communications Systems, Attack Directors, Mine Detecting Devices, Servo Control Systems, Pilot's Dead Reckoning Indicators, Missile Test Equipment, Jet Engine Components and Assemblies and other critical electronic and electro-mechanical devices are but a few of the quality products that have been made by Daystrom Instrument.



DAYSTROM | **INSTRUMENT**

Division of
Daystrom Inc.

ARCHBALD,
PENNA.

SEE! Daystrom Booths 2905-2915 - IRE Show - March 18 to 21

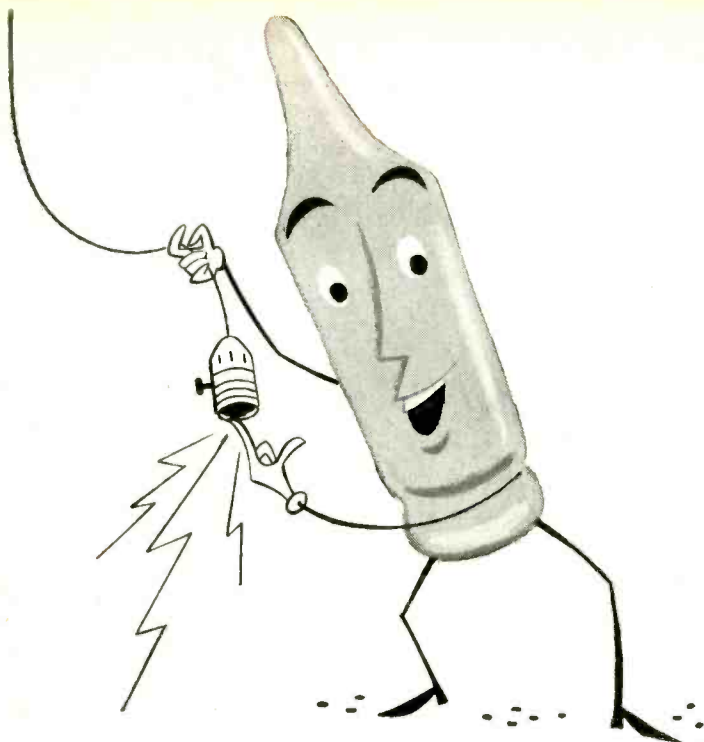

G-E GLOW LAMPS OBEY THE IMPULSE ... TO SERVE AS INDICATORS

Every live circuit should have an indicator—and with radio-type resistors, G-E Glow Lamps become simple indicators that give long, uninterrupted service. Only glow lamps offer small size, low wattage, long life, wide voltage tolerance, and rugged construction—for as little as 3½¢ each! They don't fail suddenly, so there's almost no chance of false indications. All these features help make General Electric Glow Lamps the ideal choice for hundreds of applications as indicators in the electrical and electronics industries.



If you'd like more information on the amazing G-E Glow Lamps, send today for your free copy of the folder, "G-E Glow Lamps for Pilot and Indicator Use". Write: General Electric Co., Miniature Lamp Dept. E-3, Nela Park, Cleveland 12, Ohio.

A Single G-E Glow Lamp May Serve As A:
RELAXATION OSCILLATOR • LEAKAGE INDICATOR
SWITCH • VOLTAGE REGULATOR • VOLTAGE INDICATOR

Progress Is Our Most Important Product

GENERAL  ELECTRIC

in connection with a sampling probe (which reduces sensitivity) or in connection with some kind of a test chamber into which the units are inserted. The instrument is costly, however; besides, the cans are usually filled with dry nitrogen rather than with helium.

► **Problems**—Several problems had to be overcome. For mass production tests, the units have to be locked in and locked out of the high vacuum testing chamber continuously. During this process, the pressure in the test chamber should never become higher than about 10^{-3} mm Hg whether small or big leaks are present because the gas may be absorbed on the walls, requiring either an undue time for pumping off again or limiting the sensitivity by virtual leaking. Absorbed gas and volatile materials on the outside of the samples to be tested had to be removed by a proper method of cleaning. No spurious leaking along any moving parts of the leak tester could be tolerated. Pumping or gettering

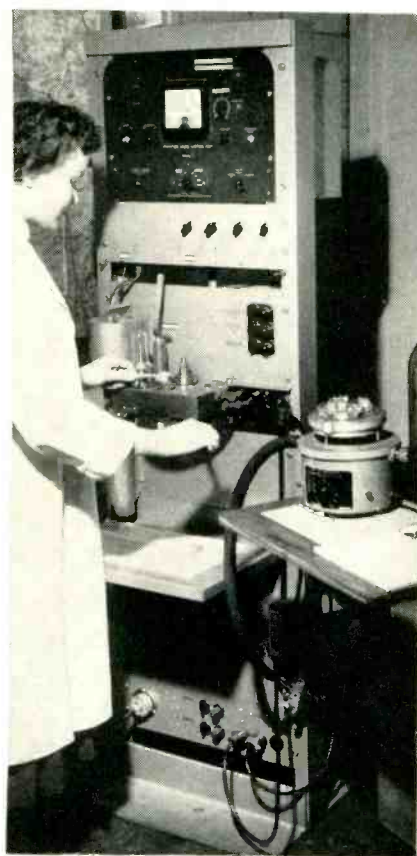

Operator loads quartz crystal unit into pouch of carousel with left hand. Right hand is on lever that indexes turntable to next position



wire for the electronic age

A new electronic miracle in the making? From the drawing board through to the final assembly, each step must be measured by the one standard that can assure attaining the full wonders of the electronic promise. That uncompromising standard is quality.

By this measure, the choice of insulated wire is Continental. A wide range of Continental insulated wires can help you achieve new electronic miracles. Complete facilities and experience are available to explore with you the new problems of special wires for electronics.

Write for your free guide to Continental heat and moisture resistant electronic wire today.

ELECTRONIC INSTRUMENT INSULATED WIRE

600 - 3000 volt service. Sizes: 32 AWG to 6 AWG inclusive. CONSTRUCTION: stranded tinned copper, polyvinyl insulation with or without nylon jacket. Maximum operating temperature: 100°C or 110°C.

CONFORMS TO: MIL-W-16878B

COLOR CODED: 1, 2, or 3 spiral stripes over polyvinyl insulation

Continental

WIRE CORPORATION

WALLINGFORD, CONNECTICUT
YORK, PENNSYLVANIA

BOOK-OF-THE-YEAR

for
TRANSFORMER BUYERS...

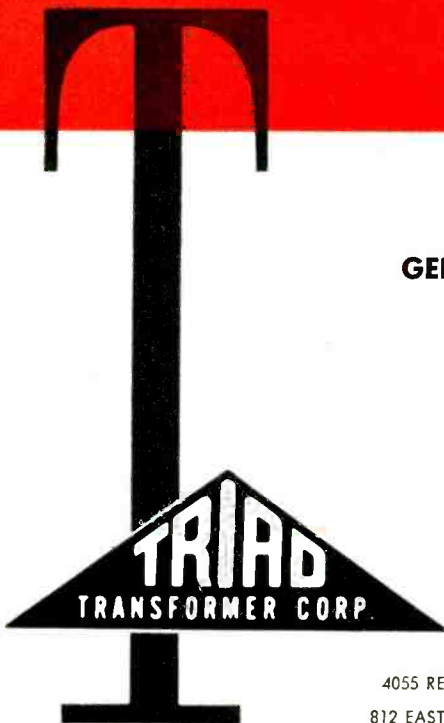
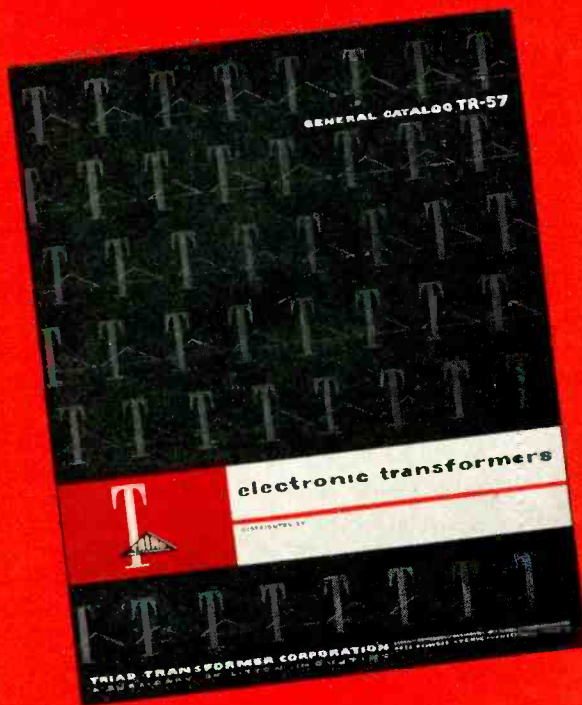

NEW TRIAD GENERAL CATALOG TR-57

Lists the complete line of transformers that have made TRIAD the symbol of quality. Includes over 75 new items. Now available from your distributor or write . . .

4055 REDWOOD AVENUE, VENICE, CALIFORNIA
812 EAST STATE STREET, HUNTINGTON, INDIANA

A SUBSIDIARY OF LITTON INDUSTRIES

effects by the manometer had to be avoided. All these requirements were met by the apparatus as built and described here.

► **Carousel Construction** — The carousel lock consists of an upper stationary steel plate and a lower rotatable steel disk $8\frac{1}{2}$ inch in diameter and $1\frac{1}{2}$ inch thick. The disk has eight pouches each $1\frac{1}{4}$ inch deep, into which the specimens may be fed through a hole cut in the stationary plate. This disk turns around a pivot in close contact with a round area of the stationary rectangular steel plate, also $1\frac{1}{2}$ inch thick, into which a number of channels are bored to connect the

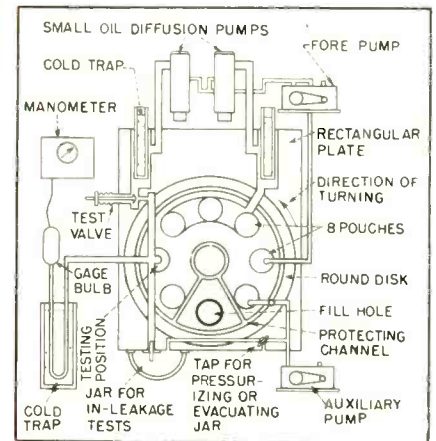

Arrangement of leak detector units

pouches with different vacuum pumps when the disk is turned around. The lock was manufactured to specifications by Extrusion Machine Co. Ltd., Toronto.

The two contacting surfaces of this carousel are ground one against the other as for grinding optical lenses. Two annular grooves divide each possible leaking path from the atmosphere to the high-vacuum chamber into two parts. These grooves, forming a protecting channel, are connected with a small auxiliary pump which keeps the pressure below 0.7 mm Hg. Thus, any possible leaking path to the high-vacuum chamber has only $1/1,000$ th of the atmospheric pressure at its inlet, reducing spurious leaking more than $1/1,000$ th. As a lubricant having a vapor pressure below 10^{-7} mm Hg, Apiezon oil C is applied.

► **Manometer**—For the manometer, a model 3 thermionic ionization



US-KON CONDUCTIVE CARDS

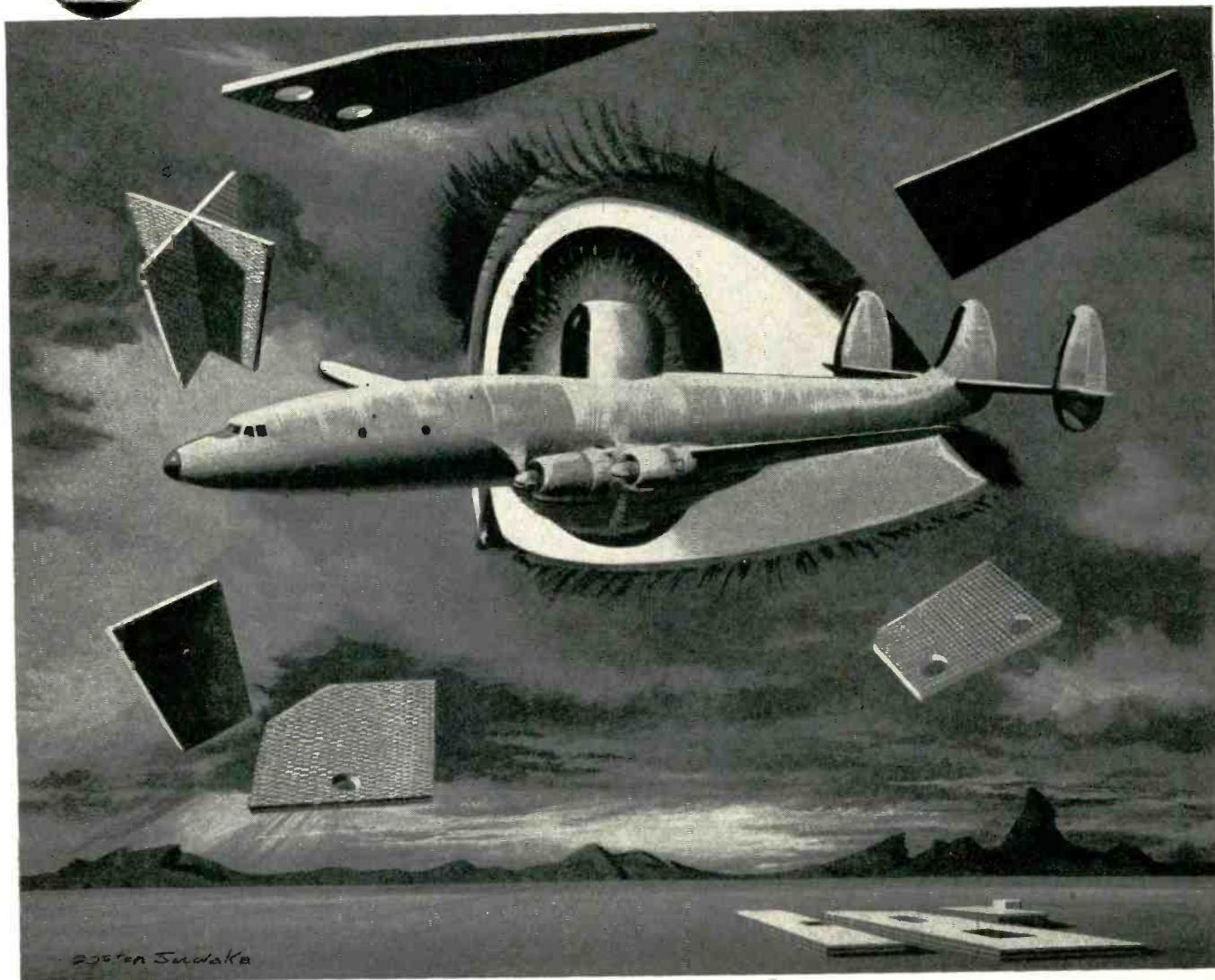

The Eyes of TEXAS INSTRUMENTS

use "resistance cards" to see what's ahead . . .

Texas Instruments Incorporated is one of the leading makers of airborne military radar. Installed within their radar microwave waveguide assemblies are Us-Kon® Electrically Conductive Cards which control the attenuation of electromagnetic energy. This assists today's high-speed, long-range military aircraft in seeing through darkness, fog and all kinds of weather with *new sensitivity, more accurate perception.*

Here are TI's reasons for using Us-Kon Conductive Cards:

- Superiority in machinability and durability
- Resultant low spoilage in process
- Controlled conductivity

Many new uses are foreseen for these versatile components. If you have a problem of electrical conductivity, especially where space, weight and upkeep are important

factors, we invite you to get in touch with us. Us-Kon Sales Dept., Mechanical Goods Division, United States Rubber, Rockefeller Center, New York 20, N. Y.

The superior conductivity and versatility of Us-Kon Conductive Cards may suggest ways you can use them profitably. Tell us the type of your product or application. E.L.

Write United States Rubber
Mechanical Goods Div., Rockefeller Center
New York 20, N. Y.

Name _____

Address _____

City _____ Zone _____ State _____



Mechanical Goods Division

United States Rubber

a quarter-turn fastener

for thin material and
miniaturized
equipment

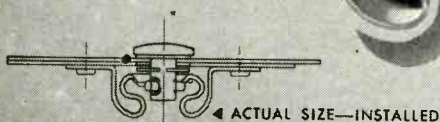
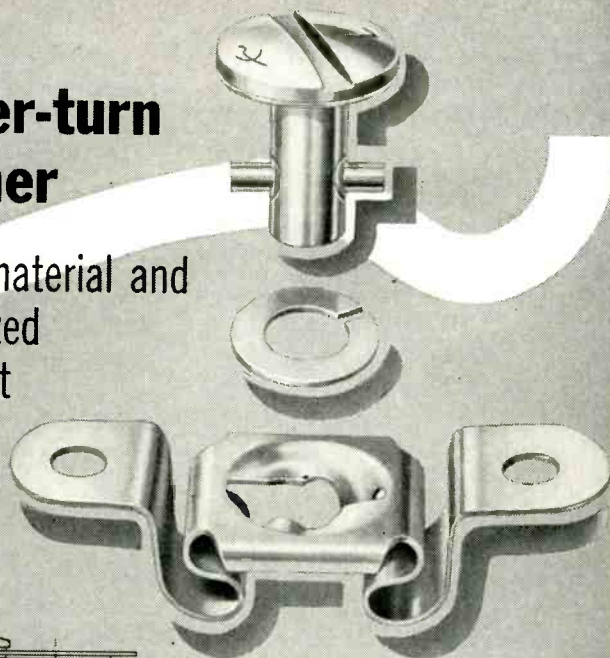

CAMLOC *low cost/light weight*

5F series

Camloc's new small, lightweight 5F Series features high strength-weight ratio plus the quick-operating advantages of a ¼-turn fastener... in a size and weight that offers new design possibilities to original equipment manufacturers! Particularly adaptable to thin materials and miniaturized equipment like airborne electronics, small electro-mechanical and computing devices and communications components. Ideal for attaching lightweight components in "packaged" equipment or for holding access panels on everything from washing machines to radar units.

Offered in many different head styles. Complete specifications will be sent to you on request.



FASTENER CORPORATION
75 Spring Valley Road, Paramus, N. J.

WEST COAST OFFICE: 5410 WILSHIRE BLVD., LOS ANGELES, CAL.
FORT WORTH OFFICE: 2509 W. BERRY ST., FORT WORTH, TEXAS
VISIT US AT BOOTHS 4401 AND 4403, I.R.E. SHOW

PRODUCTION TECHNIQUES (continued)

gage made by Edwards High Vacuum Ltd. is used in series with a cold trap filled with liquid air. All the parts are assembled using O-rings and loose flanges. The cold traps in the pumping lines are filled only if the highest sensitivity and speed is required. In this case, the gage can also be operated with a lower current than usual, reducing any possible gettering effects to a negligible amount.

► **Operation** — The samples are cleaned by washing them in trichlorethylene, then warmed on a hot plate to 80-110 C to remove moisture. To increase the speed and sensitivity of the test, the hot plate may be put under a vacuum jar connected with the auxiliary pump. The cleaned units are put into the pouches through a filling hole in the upper stationary plate. As the carrousel rotates, a connection with the auxiliary pump is made first, followed by the fore-pump of two small oil diffusion pumps, then by the first of the oil diffusion pumps which brings the pressure in the pouch down to about 1×10^{-5} mm Hg. The pouch is then at the testing position, where it is connected with the second of the oil diffusion pumps and the manometer.

If in the testing position a pressure of 2 to 5 x 10^{-6} mm Hg is reached, usually after 15 to 20 seconds, a test valve is pressed down to close the pump line. The manometer and pouch with the specimen now form one closed chamber and the manometer is watched for a pressure increase.

Usually, a small amount of gas is given off by the walls of chamber and specimen, causing a pressure rise of 0.5 to 2 x 10^{-6} mm Hg within the first few seconds, depending upon how long the pouch was cleaned by pumping at 10^{-6} mm Hg. After 15 seconds it can usually be decided whether a small leak is present or not. Larger leaks cause an immediate pressure increase to 10^{-5} or 10^{-4} mm Hg; as soon as such a rapid rise is seen, the test valve in the pump line is opened immediately in order not to contaminate the test chamber. Due to the test valve, there is no danger that even very big leaks will con-



VISIT US
AT THE
I.R.E. SHOW,
BOOTH
3815-3817



MEASURING THE "RISING SUN"...

35 times bigger than life, a "rising sun" anode appears on the contour projector screen to undergo an exacting test. To pass it, the dimensions must fall within hairline tolerances of ± 0.0005 " to 0.001 ".

Later, the frequency of this anode will be tested . . . and there will be other careful checks, all along the line, to make sure it measures up to the standards demanded of all Bomac microwave products.

Multiply this series of tests by a few hundred — for each of the 750 types of Bomac products — and you get some idea of the attention given here to testing and quality control. It is this constant control that has helped make Bomac a leader in its field . . . that gives each and every Bomac product an extra measure of dependability.

Bomac LABORATORIES, INC.
Beverly, Mass.

Offices in major cities: — Chicago • Kansas City • Los Angeles • Dallas • Dayton • Washington
Seattle • San Francisco • Toronto Export: Maurice I. Parisier, 1860 Broadway, N. Y. C.

Want more information? Use post card on last page.

Positions now open for both junior and senior engineers in microwave tube design and development. The work is challenging, advancement opportunities unlimited, and benefits liberal.

Standard types of COMMUNICATION EQUIPMENT

Radio Engineering Products is currently producing a number of types of equipment, electrically and mechanically interchangeable with standard Bell System apparatus. Complete equipments of the following types, and components for these equipments are available for early delivery.

CARRIER-TELEPHONE EQUIPMENT

- C5 Carrier-Telephone Terminal (J68756). A kit for adding a fourth standard toll-grade channel to existing C systems is available.
- C1 Carrier-Telephone Repeater (J68757)
- 121A C Carrier Line Filter and Balancing Panel
- H Carrier Line Filter and Balancing Panel (X66217C)

CARRIER-TELEGRAPH EQUIPMENT

- 40C1 Carrier-Telegraph Channel Terminal (J70047C)
- 140A1 Carrier Supply (J70036A1, etc.)
- 40AC1 Carrier-Telegraph Terminal
- Grid Emission Test Set (J70047D1)

VOICE-FREQUENCY EQUIPMENT

- V1 Telephone Repeater (J68368F)
- Power Supply (J68638A1)
- V1 Amplifiers (J68635E2 and J68635A2)
- V3 Amplifier (J68649A)
- V-F Ringers (J68602, etc.)
- Four Wire Terminating Set (J68625G1)
- 1C Volume Limiter (J68736C)

D-C TELEGRAPH EQUIPMENT

- 16B1 Telegraph Repeater (J70037B)
- 10E1 Telegraph Repeater (J70021A)
- 128B2 Teletypewriter Subscriber Set (J70027A)
- Composite Sets, several types

TEST EQUIPMENT

- 2A Toll Test Unit (X63699A)
- 12B, 13A, 30A (J64030A), and 32A (J64032A) Transmission Measuring Sets
- 111A2 Relay Test Panel (J66118E)
- 118C2 Telegraph Transmission Measuring Set (J70069K)
- 163A2 Test Unit (J70045B)
- 163C1 Test Unit (J70045D)

COMPONENTS AND ACCESSORIES

- 255A and 209FG Polar Relays
- Repeating Coils, several types
- Retard Coils, several types
- 184, 185, 230A and 230B Jack Mountings

VACUUM TUBES

101D, F & L	323A & B	396A
102D, F & L	328A	398A
104D	329A	399B
205D	336A	400A
274A & B	350A & B	408A
281A	355A	120A Ballast Lamp
305A	393A	121A Ballast Lamp
310A & B	394A	

RADIO ENGINEERING PRODUCTS

1080 UNIVERSITY ST., MONTREAL 3, CANADA

TELEPHONE
UNiversity 6-6887

CABLES
RADENPRO, MONTREAL

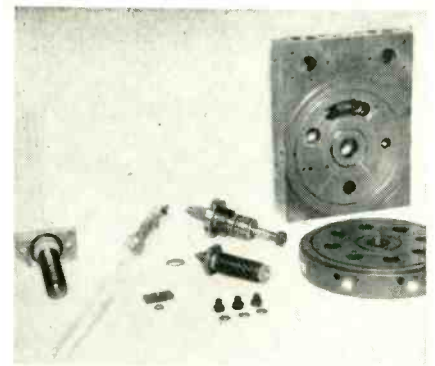

Components of carousel

taminate the apparatus or cause a burn-out of the gage.

As long as the test valve is open the pressure in the test chamber will be determined by the equilibrium between leak rate and pumping rate. For leaks which show up in a bubble test, the equilibrium pressure is in the order of 10^{-4} to 10^{-5} mm Hg. If that sample is left in long enough, it would be emptied by the pumping. Calculations show, however, that more than an hour would be required to empty it so far that it would no longer be seen in the test. The apparatus can thus be used for big leaks as well. Most of the leaks found were 100 to 1,000 times larger than the minimum detectable size.

For tests in a manufacturing line, sensitivity often can be sacrificed for higher testing speed. The apparatus can then be equipped with a simpler manometer and the cold trap omitted. Nevertheless, the tests will still be much more sensitive and reliable than bubble tests, and also nondestructive.

► **Test Procedure** — The test set should be put into operation by an experienced technician. For the tests themselves, no special knowledge is required. A test series would proceed in the following manner.

A group of units is cleaned, generally in trichlorethylene, to remove soldering flux residues and other contamination, then dried on a hot plate. The first unit is picked up with tweezers and put into pouch No. 1. The carousel disk is turned one position with a key, the second unit is put in pouch No. 2 and the carousel is turned again. The other pouches are similarly filled until pouch No. 1 reaches the

where precision counts — it's S.E.C. first!

PLASTIC PRECISION CAPACITORS

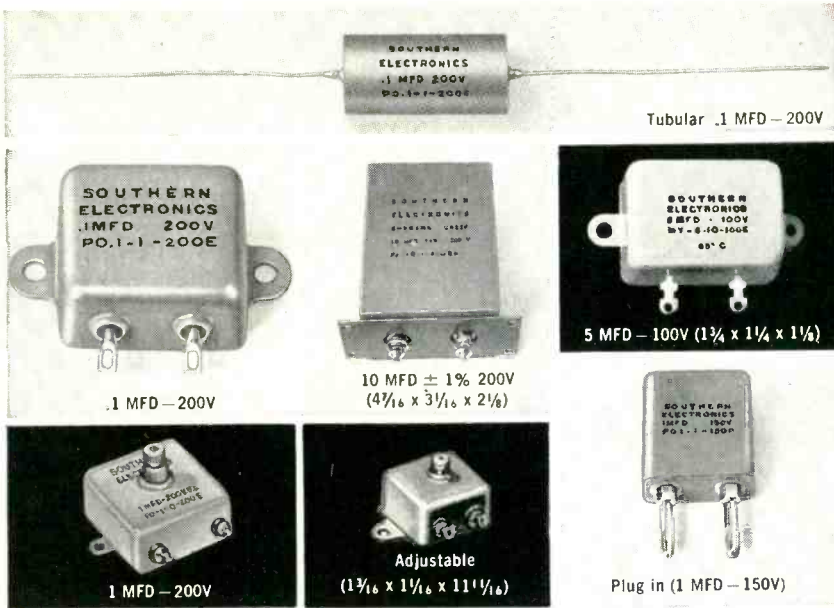

Tubular .1 MFD — 200V

.1 MFD — 200V

10 MFD ± 1% 200V

(4 1/16 x 3 1/16 x 2 1/16)

5 MFD — 100V (1 3/8 x 1 1/4 x 1 1/4)

Plug in (1 MFD — 150V)

1 MFD — 200V

Adjustable

(1 3/16 x 1 1/16 x 1 11/16)

I. POLYSTYRENE

with these outstanding properties:

- Tolerances as close as 0.1%
- Insulation Resistance as HIGH as 1×10^{12}
- Dielectric Absorption as LOW as .0001
- Dissipation Factor as LOW as .0002
- Temperature Coefficient... 100PPM per °C
- Stability as close as .05% drift in 1 yr.
- Voltage Derating... none to 170°F.
- Hermetically sealed for enduring accuracy!

also available:

- Many other case styles or mounting brackets
- Any capacitance from .001 to 50 MFD (incl. special values)
- Voltages from 50 to 5000

2. POLYESTER

with these outstanding properties:

- Tolerances as close as 1%
- Insulation Resistance as HIGH as 1×10^{11}
- Dielectric Absorption as LOW as .001
- Dissipation Factor as LOW as .003
- Temperature Coefficient... 800 PPM per °C
- Temperature range..... to 150°C.
- Hermetically sealed for enduring accuracy!



4 MFD — 300V (2 x 2 x 1)

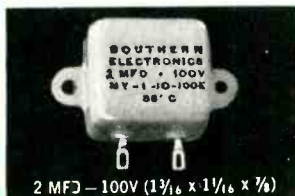

2 MFD — 100V (1 1/16 x 1 1/16 x 7/16)



120 MFD ± 10% 50V



1 MFD — 400V (1 3/4 x 1 1/4 x 1)



Plug in (4 MFD — 150V)

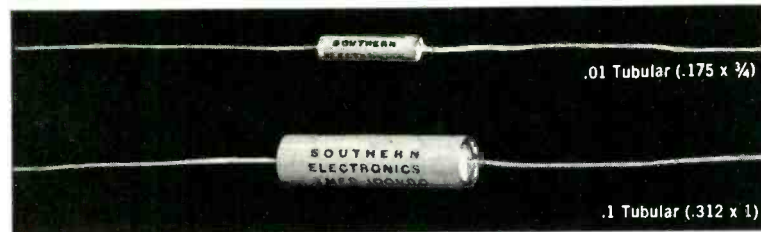

.01 Tubular (.175 x 3/4)

.1 Tubular (.312 x 1)



Printed Circuit Small .11 MFD — 50V



10 MFD — 100V (2 x 2 x 1 1/16)

3. RC NETWORKS

- Close tolerances
- Hi-grade precision resistors

- Potted units
- Meet mil specs

Many other types of precision RC Networks available!

S.E.C. PRODUCTS HAVE BEEN SPECIFIED IN SEVERAL MISSILE APPLICATIONS!

SOUTHERN ELECTRONICS

Corporation



For your most exacting requirements — always specify S.E.C.

239 West Orange Grove Ave., Burbank, California

PIONEERS IN CUSTOM PRECISION CAPACITOR ENGINEERING

See us in Booth 2309 I.R.E. Show — New York

from Magnet Charger

HEADQUARTERS

MODEL 942

*Recommended
by Leading
Magnet
Makers*



**3
VERSATILE
MODELS**

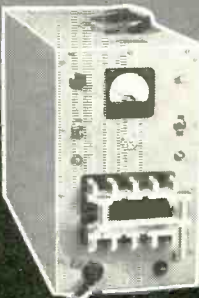

MODEL 107A

For saturating Alnico magnets weighing up to 34 lbs. and high flux ceramic magnets of any shape or pole configuration. Operates on condenser discharge principle from regular 115-volt, 60-cycle line.

Charging outputs from 100,000 to 200,000 ampere-turns through plug-in transformers, up to 3600 watt-seconds using wire-wound fixtures. Adapters for multi-pole rotors, rod, bar, ring and various other shapes available. Designed for continuous production use with low power consumption. Price of basic unit is less than \$2100.

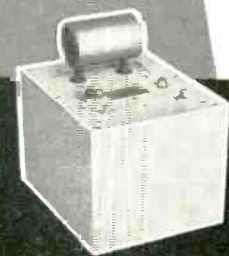

MODEL 1221

A basic condenser discharge unit for most medium size magnets, the Model 107A provides ranges of 12,000 and 24,000 ampere-turns. It is capable of saturating most instrument magnets, including the new core type mechanisms, using adapters or wire-wound fixtures. Designed for continuous duty. Operates from 115-volt, 60-cycle line. Price \$530.

A low cost, condenser discharge unit employing novel, plug-in wire-wound type charging fixtures, the Model 1221 is designed for the user of small magnets. Its 10,000 ampere-turn output will saturate about 2" of Alnico V. Charging cycle rate is approximately 3 seconds, continuous duty, operates from 115-volt line. Price \$180.

Performance of all models is rigidly guaranteed. Prices are net f.o.b. Boonton, N.J. and subject to change without notice.



**WE CAN
HELP
YOU**

12 years' magnet charging experience is yours for the asking—send for illustrated data sheets.



**Radio Frequency
LABORATORIES, INC.**
Boonton, New Jersey, U. S. A.

testing position. Here the operator watches the pressure for about 15 seconds, then presses the test-valve control and watches the pressure again. If a pressure rise indicates a leak in the specimen, he puts a marker on that pouch, releases the valve and turns the carousel to the next position. After another step the first unit, designated by a marker if leaking, comes to the filling position. Here it is taken out, set aside and the pouch filled with a new unit.

The author is indebted to Dr. A. E. R. Westman, Director, Department of Chemistry, and to his colleagues, Drs. D. B. DeLury and M. H. Jones, for their interest and help. Valuable support was given by the Project Officer, W. R. Prendergast. The work was performed under Defense Research Board ECDC Project C19 (PCC No. D48-55-60-22 Contract No. P69-10-116).

Solder-Flux Dispenser

SQUEEZE-BOTTLE DISPENSERS for a new solder-flux paste make it possible to clean, flux and solder joints in one quick operation. The new Redi-Mix product, manufactured by Anchor Metal Co., Inc., Brooklyn, N. Y., is a special combination of high-strength tin-lead solder and chemically active corrosive flux suspended in an agent that assures free flow regardless of how long it remains in the bottle. The paste joins, tins and solders practically all housing and chassis metals except aluminum and magnesium. Being corrosive, it is not intended for electrical connections. As yet, it has not been possible to achieve a rosin-flux solder paste in which the rosin stays intimately mixed with the solder.

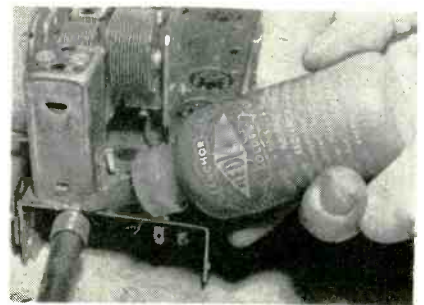

Squeeze-bottle dispenser expedites soldering to steel chassis by applying solder and flux simultaneously

What?...a Pulse Transformer...



Yes . . .

the world's most powerful and largest (over 49,000 lbs.!) The prototype core-and-coil unit being checked is a 1/10 scale model of the big unit. Circuit parameters of the scale model were checked before fabrication of the giant. Minor adjustments were made to the design so that the unit would operate satisfactorily in its final system. Thus, another Moloney job well done.

Whether you need a giant like this, or production in quantities of our minimum size (500 watts average power, 15 KV output), Moloney will do such an outstanding job that you will say, "What a Pulse Transformer!"

Produced for RCA under contract to Rome Air Development Center

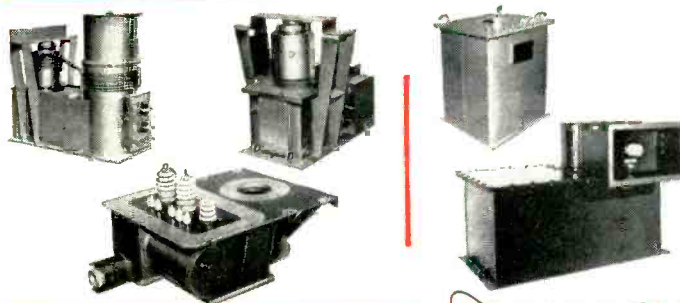

Specify Moloney . . . for pulse transformers and other magnetic components for electronic applications. Only Moloney can offer you unmatched technical know-how and experience . . . the industry's finest manufacturing facilities . . . research and development engineering personnel with the ability to resolve your problems . . . the industry's finest and most extensive test facilities.

ASA, RETMA, MIL-T standards or your own particular requirements can be complied with according to the need.

ME 87-2

Write for Catalog SF 206 "HyperCores for Magnetic Components" and Catalog ST 3546 "Magnetic Components for Electronic Applications."



MOLOONEY ELECTRIC COMPANY

Plate and Filament Transformers • Chokes • Unit Rectifiers • Modulation Transformers and Reactors • Pulse Transformers and Charging Chokes • HyperCores for Magnetic Components • Developmental Magnetic Components • Power and Distribution Transformers

FACTORIES AT 5390 BIRCHER BLVD., ST. LOUIS 20, MO., AND TORONTO, ONT., CANADA

New Products

Edited by WILLIAM P. O'BRIEN

100 New Products and 55 Manufacturers' Bulletins Are Reviewed
. . . Control, Testing and Measuring Equipment Described and
Illustrated . . . Recent Tubes and Components Are Covered

AUDIO LEVEL INDICATOR

for r-f square law detector

WEINSCHEL ENGINEERING, 10503 Metropolitan Ave., Kensington, Md. Model IN-1 audio level indicator consists of a variable gain amplifier broadly tuned to 1,000 cps driving a rectifier type a-c indicating instrument which responds to the average level. The time constant of the indicating



meter is adjustable to increase the accuracy of the observation of the

small signals in the presence of noise.

This unit makes an ideal companion instrument to the bolometer preamplifier, BA-1A, and the a-f substitution attenuator, CF-1, allowing the maximum use to be made of these instruments for r-f insertion loss measurement. At maximum gain a 100- μ a signal gives full-scale indication. **Circle P1 inside back cover.**

DIGITAL OHMMETERS

two new types offered



NON-LINEAR SYSTEMS INC., Del Mar Airport, Del Mar, Calif. Fast,

automatic and precise measurement of a wide range of resistance values, with very small currents passed through the test resistance, is provided in models 758 and 759 digital ohmmeters. To assure maximum, trouble-free life, each model features the NLS oil-sealed stepping switch system.

Resistance values are displayed in a horizontal line of inch-high luminous numerals, with the decimal point and resistance symbol shifting automatically. Connection

of accessory NLS digital recording systems provides permanent records.

Model 758 displays four digits with a range of 0.0001 K to 9999 K. Accuracy is ± 0.1 percent of value read or one digit, whichever is greater.

Model 759 displays five digits and has a range of 0.0001 K to 9999.9 K. Accuracy is $\pm (0.01$ percent of value measured + 1 digit) in the lowest range and decreases to $\pm (0.1$ percent of value measured + 1 digit) at the upper end of the highest range. **Circle P2 inside back cover.**

H-C POWER SUPPLY

for transistor work

DRESSEN-BARNES CORP., 250 N. Vinado Ave., Pasadena, Calif., announces a low-voltage, high-current power supply developed for transistor work and other uses requiring excellent regulation and microsecond response.

Output is 0 to 50 v d-c, continuously variable without switching; current 0 to 1,000 ma maximum.

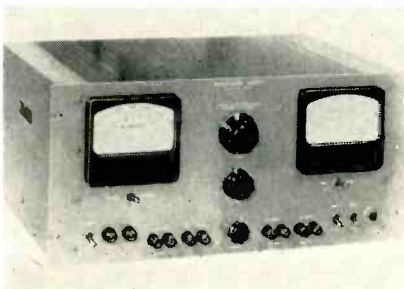

Full output current is available, without derating, throughout the entire range. A second output supplies 6.3 v a-c at 10 amperes. Recovery time from 0 to full load is 0.5 millisecond; from full load to removal, 0.25 millisecond.

Regulation for 50-v, 1,000-ma output is 80-mv change, no-load to full-load. For line voltages of 105 to 125 v, regulation is 0.1 percent change in output voltage. Outputs may be pulsed with square-wave



our leadership protects yours...

It takes a lot of doing to produce the exact same thing over and over again hundreds of thousands of times—without slipping up on a thousandth of an inch, watt, or milligram. This insistence on *uniformity* has helped build our reputation as the world's most Consistently Dependable producer of CAPACITORS. Continuously uniform production is a science—one that we've painstakingly pursued since 1910.

Typical of the "countless" C-D electrolytics used by major equipment manufacturers the world over are:

"EC" MINIATURIZED CERAMIC CASED TUBULARS For cramped-space applications in hearing aids, transistorized devices, and remote control assemblies. Less than $\frac{1}{4}$ " D., only $\frac{3}{4}$ " L.

"NL" ULTRA-SMALL Hermetically sealed aluminum cased electrolytics, built for compactness, ruggedness, low leakage, long shelf and in-use life.

TANTALUM 3 tubular types, all with low power-factor, moisture-impervious hermetic seal, long service and especially long shelf life. "TX" with sintered anode; "TAN" miniature foil type; sub-miniature, low-voltage wire anode type "NT".

TYPE "UP" Made in the smallest tubular aluminum cans possible for any given capacity and voltage combination. In single, dual, triple and quadruple capacity combinations.

Write for catalog to Cornell-Dubilier Electric Corporation, South Plainfield, New Jersey.



CONSISTENT HI-DEPENDABILITY CORNELL-DUBILIER CAPACITORS

SOUTH PLAINFIELD, N. J.; NEW BEDFORD, WORCESTER & CAMBRIDGE, MASS.; PROVIDENCE & HOPE VALLEY, R. I.; INDIANAPOLIS, IND.; SANFORD, FUGUAY SPRINGS & VARINA, N. C.; VENICE, CALIF.; & SUB.: THE RADIART CORP., CLEVELAND, OHIO; CORNELL-DUBILIER ELECTRIC INTERNATIONAL, N. Y.

load without affecting normal regulation. Ripple and internal noise for 50-v, 1,000-ma output is below three mv rms. Accurate setting

of output voltage is provided by a three-turn Helipot.

Designated model 5-1MB, the unit is of standard 7 in. by 19 in.

relay rack construction, with a depth of 15 in. Literature is available on request. **Circle P3 inside back cover.**

SELENIUM RECTIFIER

with wrap-around design

FEDERAL TELEPHONE AND RADIO CO., 100 Kingsland Road, Clifton, N. J., has announced a new type of 65-mil selenium rectifier with a metal wrap-around design. It has its individual cells placed flat against each other like pages in a book instead of being placed on a center shaft with an air space between cells.

► **Advantages**—Center mounting shafts, with associated nuts and washers, are eliminated, giving more rugged construction and greater protection against con-

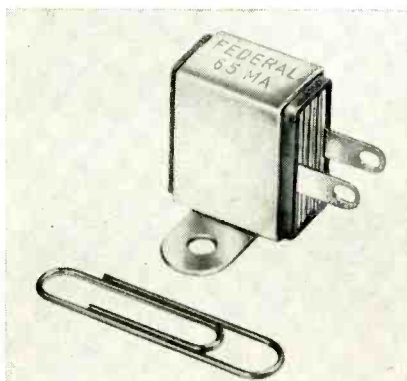

tamination by moisture. The metal wrap-around provides thermal coupling to the chassis which acts as

a heat sink, so that air cooling is not necessary. This permits flexibility of mounting, an important consideration in portable equipment where space is at a premium and where conventional rectifiers often have to be mounted to allow cooling by air convection. The wrap-around also protects the rectifier from physical damage and permits it to be easily screw mounted, riveted or eyeleted.

Elimination of the center hole gives each cell a larger effective area and a greater current safety factor. Addition of a seventh cell provides another safety factor, voltagewise, over six-cell rectifiers. **Circle P4 inside back cover.**

MAGNETIC AMPLIFIER

designed for servo systems

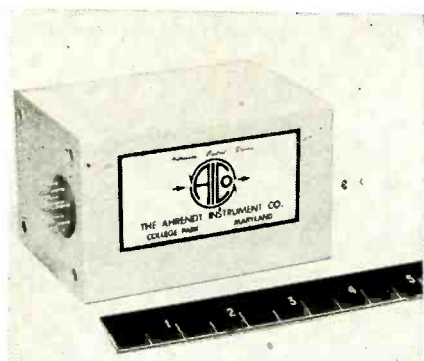

THE AHRENDT INSTRUMENT CO., 4910 Calvert Road, College Park, Md. Designed for self-contained 400-cps input signals, this magnetic amplifier is adaptable to input signals from d-c to 1,000 cps with the addition of a reference transformer. It is suitable for driving a Bu Ord Mk 7 or Mk 8 servo motor or equivalent. It does not require any vacuum tube or transistor driving stage in a

normal servo loop.

Magnetic amplifier C-150-223 is a rugged, reliable amplifier designed for use in instrument and computing servo systems. It is potted and hermetically sealed in a MIL-T-27A size HA can. Circuit is of full-wave design. External circuitry is reduced to a minimum through built-in servo motor reference and anti-stickoff voltage for double speed data systems. It meets shock and vibration requirements of MIL-STD-202. **Circle P5 inside back cover.**

ANTENNA

for use with marker beacon receiver

TELECTRO INDUSTRIES CORP., 35-16 37th St., Long Island City 1, N. Y. Model AT-134 is a 75-mc marker-beacon antenna designed specifically for use with aircraft type marker beacon receivers. It is installed by flush mounting it on the bottom of an airplane fuselage.

The external arrangement is a flanged deep drawn aluminum alloy case forming the antenna cavity, with the slotted shaft of the variable loading capacitor extending through the closed top of the

case to permit screwdriver adjustment and tuning. The flanged bottom or airplane surface side of



the antenna, as furnished, is open. On the short sides of the cavity are the receptacle for the connection of the lead-in and an 18-mm threaded hole. The hole may be closed by a plug, but it is intended to be used for antenna dehydration. This may be accomplished either by screwing into the hole an 18-mm spark-plug type dehydrator, or by connecting to a remote dehydrator.

The internal arrangement includes a shunt-fed bent-channel receiving element, top loaded by a small variable capacitor in parallel with a 25- μ f temperature-

A DESIGN CONCEPT*

—that revolutionized an industry!

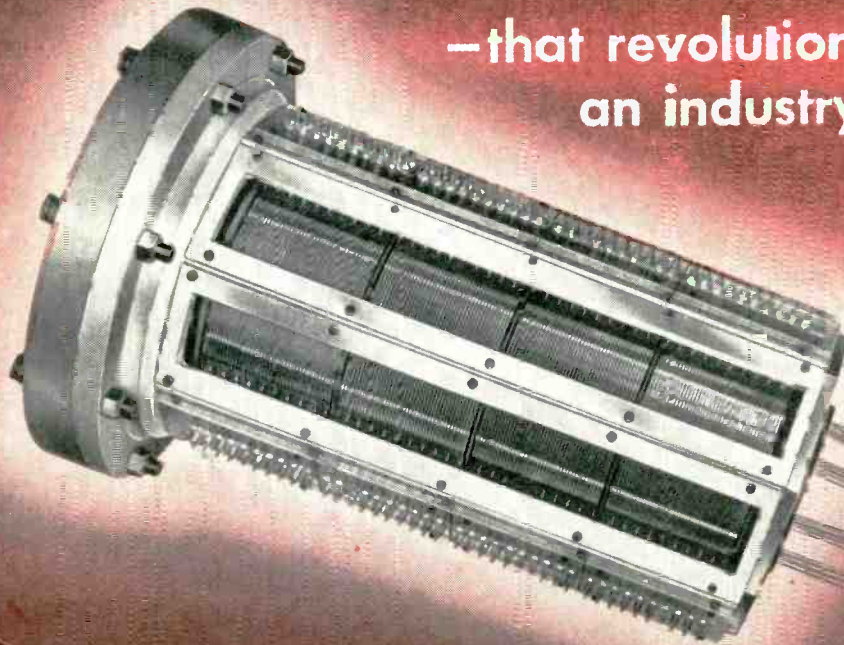

ELECTRO TEC

**PRECISION MACHINED
ONE-PIECE CONSTRUCTION**

Diameters of multi-ring assemblies from .035" to 36"



Individual components or complete assemblies to precise electrical, mechanical, and environmental specifications.

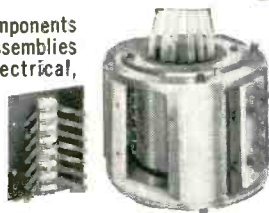

**SLIP RING &
COMMUTATOR
ASSEMBLIES**

An Unmatched Record of Performance

Today, Electro Tec Slip Ring and Commutator Assemblies are the choice of leading aircraft, instrument, and component manufacturers throughout the world. Our units are selected for Gyro and Servo applications, for Telemetry and Radar devices, for Guidance systems, and Automation equipment... where sustained and reliable performance is a requisite.

Facilities Available to Serve You

Plants in South Hackensack, N. J., Blacksburg, Va., and Ormond Beach, Fla., are currently producing a wide variety of Slip Ring, Commutator, and Brush Block Assemblies, Precision Selector Switches, and Miniature Relays. Complete Engineering Facilities and Branch Sales Offices in Los Angeles, Minneapolis, Chicago, and Waltham, Mass. are geared to service your requirements.

Write for fully illustrated literature.

Uniformly hard rings, low noise, minimum friction and dimensional stability.

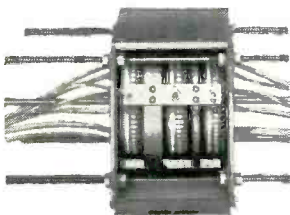

See us at the
I.R.E. Show!
BOOTHS
1216, 1218,
1220

ELECTRO TEC CORP.
SOUTH HACKENSACK, NEW JERSEY

PRODUCTS OF PRECISION CRAFTSMANSHIP



*PATENT No.
2,696,570



■ Research and development at Lockheed Missile Systems Division laboratories in Palo Alto is of a most advanced nature. Particular areas of interest include microwaves, telemetering, radar, guidance, reliability, data processing, electronic systems, instrumentation, servomechanisms. Inquiries are invited from those qualified by ability and experience for exploratory efforts of utmost importance.

Here members of the Electronics Division discuss systems radar problems related to measurement of missile trajectories. Left to right: K. T. Larkin, radar and command guidance; Dr. S. B. Batdorf, head of the Electroaics Division; Dr. H. N. Leifer (standing), solid state, Dr. R. J. Burke, telemetering; S. Janken, product engineering.

Lockheed

MISSILE SYSTEMS DIVISION

research and engineering staff

LOCKHEED AIRCRAFT CORPORATION

PALO ALTO • SUNNYVALE • VAN NUYS

CALIFORNIA



I·R·E NATIONAL CONVENTION AND RADIO SHOW

Significant developments at Lockheed Missile Systems Division have created new openings for:

- Controls Systems Engineers** — to analyze and synthesize complex automatic control systems.
- Inertial Guidance Engineers** — to perform systems analysis and design of inertial guidance systems.
- Infrared Specialists** — to perform preliminary systems design and parametric optimization of advanced infrared detection systems.
- Data Processing Systems Specialists** — to perform advanced system development and design in new techniques of automatic data processing.
- Weapons Systems Specialists** — to perform basic analysis and systems evaluation of advanced weapons systems.
- Electronic Product Engineers** — to translate laboratory electronic systems into prototype models meeting the rigid requirements of modern weapons systems.
- Radar Systems Engineers** — to develop advanced radar systems associated with guided missiles.
- Theoretical Physicists** — to analyze propagation of electromagnetic waves through the ionosphere and through dielectric materials and study radiation problems pertaining to advanced antennas in the microwave and millimeter domain, including scattering problems related to the reflection of electromagnetic waves from simple and complex boundaries.
- Experimental Physicists** — to investigate microwave circuit components including ferrites and various millimeter wave techniques such as MAZUR.
- Antenna Specialists** — to design and develop airborne antennas and radomes for high speed missiles for telemetering, radar, and guidance systems application.
- Video Specialists** — to develop advanced systems for the transmission of visual data by electronic means.
- Circuit Design Specialists** — to design telemetering and guidance systems utilizing advanced circuit components.

Positions are open at the Palo Alto Research Center and Sunnyvale and Van Nuys Engineering Centers. M. H. Hodge, M. W. Peterson and senior members of the technical staff will be available for consultation at the convention hotel. Phone PLaza 14860 or 14861.

Lockheed

MISSILE SYSTEMS DIVISION

NEW PRODUCTS

(continued)

compensated fixed capacitor.

The model AT-134 measures 11 $\frac{1}{4}$ in. long by 7 $\frac{1}{4}$ in. wide by 3 $\frac{1}{4}$ in. high. Circle P6 inside back cover.

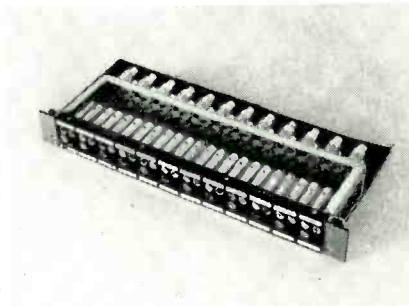

VIDEO JACK PANELS for 70-ohm line use

NEMS-CLARKE INC., 919 Jesup-Blair Drive, Silver Spring, Md., has available video jack panels designed to provide coaxial patching facilities for tv installations or other applications where 70-ohm lines are used. These panels are available with jacks for both the RCA and the Western Electric size. Individual jacks, plugs, patchcords and looping plugs are also available.

Panels may also be obtained with 12 groups of either two, three or four jacks. A subchassis is included providing 24 Amphenol connectors and plugs to allow disconnection of long lines. The spring contacts in the jacks are of heat-treated beryllium copper to give long trouble-free life. Circle P7 inside back cover.

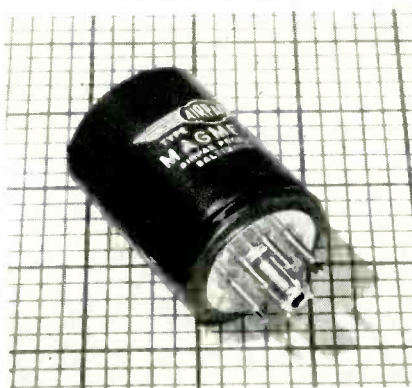

FREQUENCY DETECTOR for automatic control

AIRPAX PRODUCTS Co., Middle River, Baltimore 20, Md. For tele-



Launcelot's Sitting Pretty



"Forsooth," quoths Sir Launcelot (ye Smart Buyer of Industrial Furniture), "methinks *Royal* bids fair to convert ye whole world to ye use of goode factory seating.

"Exceeding function with comfort doth add zest to endeavor . . . prolong aptness, alertness . . . out-bounty ye fabled 'king's ransom'!"

Yes, *Royal* Adjustable Chairs and Stools bring to the assembly table, drafting room, factory office, and production machine a complete array of sturdy steel seating designed by correct-posture specialists.

Thy most stalwart Knight . . . thy fairest Maiden . . . thy Earl of Exchequer (ye Prince of ye Pocketbook) . . . all will applaud fatigue-free *Royal* Seating. Each piece is a crowning achievement.

For the world's finest industrial chairs and stools — for wardrobes, cabinets, machine stands, foremen's desks, and efficient vertical files — see your *Royal* Dealer, or mail ye coupon now!



Model 515 Model 625 Model 624 Model 511

ROYAL METAL MANUFACTURING COMPANY
175 N. Michigan Ave., Chicago 1, Ill., Dept. 30-D
Please send me free 24-page Catalog No. 7001, "Royal Seating for Modern Industry;" Complete information on *Royal* Verti-File Vertical Filing.

Individual _____
Company _____
Street _____
City & State _____

NEW full voltage coverage adjustable TRANSISTORIZED

POWER PACKS

TRANSPAC
ELECTRONIC RESEARCH
ASSOCIATES, INC.
NUTLEY, N. J.

FEATURING

- Continuous Voltage Adjustment
- All Transistor Designs
- High Conversion Efficiency
- Low Heat Dissipation
- Instant Warm-up Time
- Fast Transient Response
- Small Size, Light Weight
- Non-Microphonic Operation
- Stable, Rugged, Long Life

"TRANSPAC"® semi-conductor, regulated, transistorized, power packs supply a reliable, stable source of DC power. These tubeless models make obsolete the bulky, low efficiency, high heat vacuum tube or magnetic amplifier equivalents wherever used. Now, even greater flexibility is attained with these new adjustable voltage models. Ideally suited for guided missile circuits, portable and mobile equipment, computer units, reference applications and all types of miniature and standard size electronic devices.

STANDARD MODELS

Input 105-125 VAC, 60 or 400 cps. Input regulation better than $\pm 0.5\%$. Output regulation better than $\pm 0.5\%$. Ripple less than 0.05%. Units are potted in transformer type housings, but transistors are replaceable. Design characteristics include line isolation, high efficiency filtering and germanium transistor regulation control. Adjustment of the output voltage is made via a screwdriver adjustment accessible externally.

Model No.	Output Volts	Current Ma-Max	Case Size		Weight-Lbs.		Price	
			60 cps	400 cps	60 cps	400 cps	60 cps	400 cps
TR5A	5-10	200	D	C	1.7	1.5	\$ 80.00	\$105.00
TR10A	10-20	200	D	C	1.7	1.5	80.00	105.00
TR20A	20-30	150	D	C	1.7	1.5	80.00	105.00
TR30A	30-40	150	D	C	2.7	1.7	80.00	105.00
TR40A	40-50	150	D	C	2.7	1.7	80.00	105.00
TR50A	50-55	150	D	C	2.7	1.7	80.00	105.00
TR100A	100-110	100	E	D	4.5	2.7	100.00	120.00
TR150A	150-160	100	E	D	4.5	2.7	100.00	120.00
TR200A	200-210	100	F	E	5.7	4.5	125.00	160.00
TR300A	300-310	100	G	E	5.9	4.5	130.00	170.00

® Trade Mark Reg.

Case Size, WxDxH "D" 2-5/8 3-1/16 4-1/4 "E" 3-7/8 3-7/8 4-3/4
"C" 2-3/8 2-13/16 3-13/16 "E" 3-1/16 3-9/16 4-7/8 "G" 3-15/16 4-5/8 4-7/8

Transistorized TRANSPACS are available in a variety of both fixed and adjustable models, and designs to customer's specifications. Write for catalogue E3.

Electronic Research Associates, Inc.
67 East Centre Street, Nutley 10, N. J.
NUTLEY 2-5410

metering, instrumentation and automatic control, type F-992 Magmeter provides an output current that is linearly proportional to frequency within the band from 375 to 425 cps. Similar detectors can be provided covering a 10-percent bandwidth at any center frequency from 30 cps to five kc. The output is suitable for operating a d'Arsonval indicating instrument, a servo-type recorder, or a control circuit.

Linearity is within $\frac{1}{4}$ percent of midband frequency. Output is zero at the low-frequency end of band providing fail-safe indication in absence of input. The Magmeter detector is hermetically sealed, operates from -55°C to $+72^{\circ}\text{C}$; withstands 10-g vibration to 2,000 cps and shocks of 30 g in all directions.

The standard type fits an octal socket, is $1\frac{1}{2}$ in. in diameter, two in. seated height and weighs six oz. Circle P8 inside back cover



VOLTAGE DIVIDER

one knob controls two decades

RESEARCH INSTRUMENT CO., P. O. Box 9168, Portland 16, Oregon. Single-knob control of two decades is one of several features of this vernier potentiometer-rheostat design. The unit is a four-terminal voltage divider and may be used as a potentiometer or rheostat. Only two turns of the control knob covers the full range of the device and resolution is equal to a 10-turn pot. The complete unit mounts like a panel meter and uses only 2 by 2 in. of panel space with $2\frac{1}{2}$ in. projecting behind the panel.

Resistance is 10,000 ohms when



... for crowded panels and
dashboards .. **SPACE-SAVER CONTROLS**

**TYPES for
TRANSISTORIZED SETS;**

too! Similar to standard Stackpole miniature "F" Controls, but designed for low hop-off on the order of 2.0 ohm maximum, as compared to the higher values of conventional types. And they're electrically quiet! •

ONLY 0.637" in diameter, Stackpole "F" controls combine quiet, dependable operation with the smaller physical size needed for automotive radios and similar equipment now undergoing miniaturization.

"F" Controls are conservatively rated at 0.3-watt for values up to 10K ohms, and at 0.2-watt for higher values. Each can be equipped with new Stackpole "B"-Series line switches for practically any switching arrangement. Standard mounting types suffice in most cases—but where they don't, suitable adaptations can be produced economically for quantity users.

ENGINEERING SAMPLES available to quantity users . . .

Ask the Stackpole field engineer in your locality

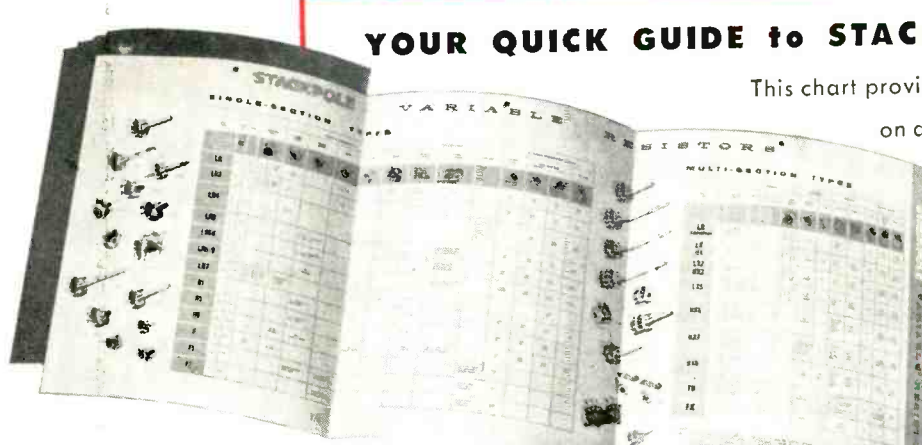

YOUR QUICK GUIDE TO STACKPOLE CONTROLS

This chart provides essential engineering data on all standard Stackpole Variable

Resistors in handiest possible form. Designed for either wall or file use. Write today for your copy.

STACKPOLE

Electronic Components Division

STACKPOLE CARBON COMPANY • St. Marys, Pa.

In Canada: Canadian Stackpole Limited, 550 Evans Ave., Etobicoke, Toronto 14, Ontario



PILOT *turned* PROPHET

BY CORNELL AERONAUTICAL LABORATORY

Six years ago, the Bureau of Ships asked C.A.L. to make a feasibility study of *automatic*, all-weather control of aircraft in return-to-carrier operations. ACCA (Automatic Carrier Controlled Approach) is our name for the project. One of the most complex phases of the project was the *electronic prediction* of a ship's movements and the subsequent use of these predictions in the total physical system.

Over the years, by combining our manpower resources in electronics with knowledge in such fields as control theory, computers, meteorology, aerodynamics, statistical analysis and information theory, we have continued to assist in making major decisions on the techniques and equipment involved. Theoretical and analytical studies have been supplemented by key experiments conducted in the Laboratory, in the air, and on the high seas.

The ACCA project is typical of the intensely interesting opportunities at C.A.L. for men capable of mentally moving forward the frontiers of scientific knowledge.

CORNELL AERONAUTICAL LABORATORY, INC. OF CORNELL UNIVERSITY



The story of Cornell's 160 current projects and those preceding them is contained in a 68-page report, "A Decade of Research." Whether you are interested in C.A.L. as a place to work or as a place to watch, you will find "A Decade of Research" both useful and pertinent. Mail the coupon now for your free copy.

W. L. Diefenbach

CORNELL AERONAUTICAL LABORATORY, INC.
Buffalo 21, New York

Please send me "A Decade of Research."

Name _____

Street _____

City _____

Zone _____ State _____

Please include employment information

used as a pot and 0 to 10,000 ohms when used as a rheostat. Accuracy is 0.1 percent of full scale; linearity, ± 0.1 percent; resolution, 0.1 percent or better; wattage, four w when used as a pot; current rating, 25 ma when the unit is used as a rheostat.

Other resistance ranges are available using either wire wound resistors such as used in the described unit or carbon or carbon-film resistors depending on the range and accuracy desired. Circle P9 inside back cover.

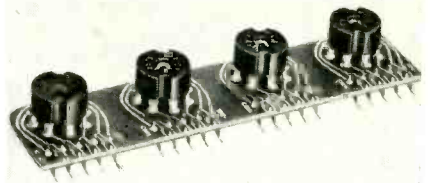

SOCKET MOUNTING

used with printed circuits

CLEVELAND METAL SPECIALTIES Co., 1783 E. 21st St., Cleveland 14, Ohio, has designed a multiple right-angle socket mounting for use in conjunction with printed circuits. The multiple mounting can be used for two, three, four or more sockets, and can be applied for the mounting of other electronic components such as resistors and capacitors that have not previously been incorporated into the circuit.

The new mounting can incorporate either sockets of the same size or sockets of varying sizes and can be constructed to meet the combinations and specifications required. Circle P10 inside back cover.

RESISTOR NETWORKS

for strain gage amplifiers

EASTERN PRECISION RESISTOR CORP., 675 Barbey St., Brooklyn, N. Y., announces new precision wire-wound resistor networks especially designed to fit the front panel of strain gage amplifiers. The company can supply any number of precision resistors in one encapsulated package. Wound on

New **ELECTRO-SNAP** SIMULTANEOUS **TRIPLE-POLE SWITCH**



(Actual Size)
K3-SERIES

TRIPLE-POLE SWITCH

OPERATING CHARACTERISTICS

CONTACT ARRANGEMENTS:

- K3-4—TRIPLE-POLE, DOUBLE THROW
- K3-2—TRIPLE-POLE, NORMALLY OPEN
- K3-1—TRIPLE-POLE, NORMALLY CLOSED

ELECTRICAL RATING:

- 15 AMP 125/250 V.A.C.
- 15 AMP 30 V.D.C. RESISTIVE
- 10 AMP 30 V.D.C. INDUCTIVE

PROBABLE MECH. LIFE.....1,000,000 OPS
 PROBABLE ELEC. LIFE.....500,000 OPS
 AMBIENT TEMP. RANGE.....-100° TO +275° F.*
 *(-100° to +375°F. available)

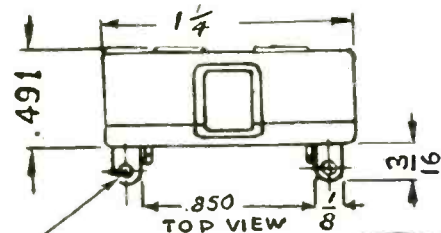
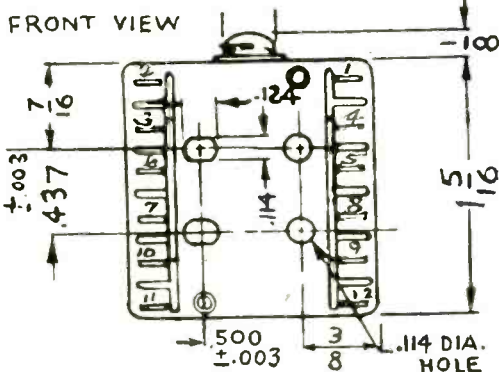

(.0675 DIA WIRE HOLES)

for interrupting 3-phase,
110 V, 400 cycle AC circuits

6-CIRCUIT CONTROL — in a small package.
Makes possible a wide variety of circuit combinations.

SIMULTANEOUS "MAKE & BREAK" ACTION
Permits unusual applications, reduces arcing, prolongs switch life and increases electrical capacity.

This completely new Electro-Snap triple-pole switch simultaneously reverses current flow through three windings of a 3-phase motor up to 1 H.P. and interrupts other types of multi-switching installations. Instantaneous snap-action of the three poles is independent of the speed of actuation — even extremely slow moving cams can be used.

The K3-Series offers designers a wide variety of 3-phase circuit hookups for servo-controls, to limit movement of machine members and as a start-and-stop switch which formerly were possible only with complicated relays or a number of separate switches. A large selection of standard actuators is available.

LOOK WHAT YOU CAN DO WITH IT!

Control Six Circuits with ONE Snap

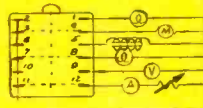

115 V. A. C.

Used in motor control device switch, when actuated, turns on the red light on No. 1, the solenoid on No. 5, the voltmeter on No. 9 and turns off the motor on No. 4, the green light on No. 8 and the furnace and ammeter on No. 12.

Wire Movable Poles in Series for High Voltage or in Parallel for High Current

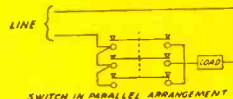

SWITCH IN PARALLEL ARRANGEMENT



SWITCH IN SERIES ARRANGEMENT

With the switch wired in parallel arrangement, the current is divided into 3 paths through the switch. This permits the switch to be used with a load rated up to 3 times the ampere rating of the switch.

series arrangement, the current has only 1 path through the switch. The multiple breaks in the current path permits the switch to be used where the line voltage is rated up to 3 times the voltage rating of the switch; ampere rating not affected.

Start and Stop Three-Phase Motors

Completely disconnect all current supplied to a 3-phase motor by interrupting 3 phases simultaneously with one snap.

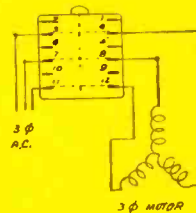

3 φ A.C.

3 φ MOTOR

ELECTRO-SNAP SWITCH AND MFG. CO.

4236 West Lake Street • Chicago 24, Illinois

MODERN DESIGN
IN A COMPLETE LINE
OF SWITCHES



Sub-Miniature Switch



Multi-Pole Switches

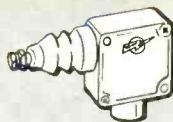

One-Way Limit Switch

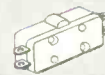

Basic Switch

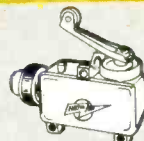

Hermetically-Sealed Limit Switches

Our NEW HOME

Ceramic tile and glass keynote the entrance to Electronic Engineering Company of California's prize-winning new laboratory and general offices at 1601 East Chestnut Street, Santa Ana, California.



*there's something about
a new home...
especially when it's
a prizewinner!*

And our new home is a prizewinner. Its design won for architect George Vernon Russell, AIA, the coveted Design Award for Industrial Architecture among a field of more than 700 entries in the 1955 national contest conducted by the magazine PROGRESSIVE ARCHITECTURE.

Located in smog-free Santa Ana, our new plant features generous landscaping, garden-surrounded research areas, well lighted work rooms... in fact, a full expression of our prime objective: To make available the best possible conditions, facilities, and atmosphere for our highly trained professional personnel.

OUR NEW HOME CAN BE YOUR NEW HOME... if you can qualify. Here are some of the engineering opportunities now available:

TRANSISTOR ENGINEER—Able to design transistor amplifiers, emitter followers, oscillator circuits, and pulse circuits.

AMPLIFIER ENGINEER—To design AC and DC amplification circuits especially in the low-level region.

DATA HANDLING ENGINEER—Familiar with digital data handling methods, transducers, telemetry technique, ground decoding equipment, etc.

PULSE ENGINEER—Thoroughly familiar with pulse circuitry, rise times, decay times, trigger levels, and impedance matching.

TIMING ENGINEER—Familiar with timing codes utilizing precision oscillators, divider networks, time registers, and read-out circuits.

SYSTEMS ENGINEER—To design detailed mechanical and electronic sequencing devices for performing intricate missile-launching functions.

Send a resume of your qualifications to Robert Lander.

Dept. EEE



Electronic Engineering Company of California

180 SOUTH ALVARADO STREET • LOS ANGELES • 57 • CALIFORNIA

NEW PRODUCTS

(continued)



glass reinforced plastic forms with glass insulated wire, each resistor is capable of dissipating 10-w overload for short periods of time.

Anodized-aluminum front panels are available in 13 different colors to facilitate ease in selection of the proper resistor block. A variety of configuration and schematics are possible. Circle P11 inside back cover.

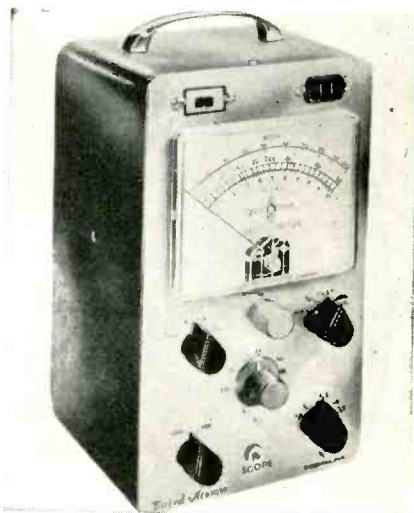

BETA TESTER portable, transistorized

BAIRD-ATOMIC, INC., 33 University Road, Cambridge 38, Mass., has announced a new portable transistorized instrument for measurement of transistor parameters in quality control testing, circuit design, incoming inspection and general trouble shooting. Model KT-1 was designed specifically for measurement of Beta, h_{11} and I_{co} . It is completely self-contained with its own one-kc oscillator and mercury-cell power supply. Battery life of the mercury cell is about 1,000 hr. Printed circuitry has been used throughout, increasing the portability and ease

It's New...!

Good-ALL
capacitors



A Space Saving capacitor
WITH **"SKIN-TIGHT" Case**

Miniature Size • Tolerances to $\pm 1\%$

This thin, tough Mylar* case provides excellent moisture and abrasion resistance — yet adds less than 1/64" to the body diameter.

Miniature size is gained through the use of space-saving mylar dielectric. High insulation resistance and real stability with life are key electrical characteristics.

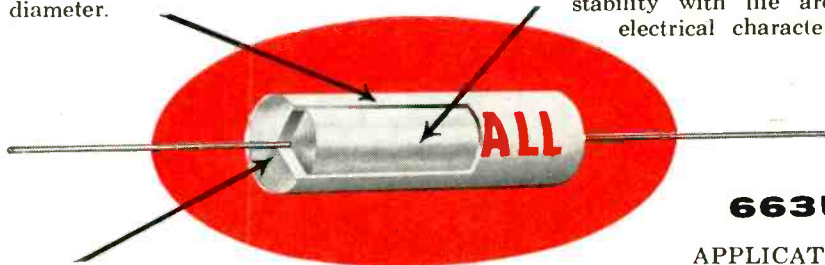

663UW

APPLICATIONS:

- Instrumentation • Filter Networks
- Transistor Circuitry • Amplifiers
- Test Equipment • Computers

A dense thermo-setting plastic that bonds securely to the lead and case. The completed assembly is rugged and durable.

SPECIFICATIONS

*DuPont's trademark for polyester film.

INSULATION RESISTANCE: See curve reproduced below for typical performance

DIELECTRIC STRENGTH: 2 times rated voltage

LEAD PULL TEST: Steady force of 10 lbs. applied axially for 60 seconds.

HUMIDITY RESISTANCE: Far exceeds requirements of RETMA Spec. REC-118-A

LIFE TEST: 250 hours at 85°C and 125% of rated voltage

TEMPERATURE RANGE: Operation at rated voltage from -60°C to +85°C and to +125°C with 50% derating.

TYPICAL SIZES

Capacity	100 Volts	200 Volts	400 Volts
.001	156 x 1/2	156 x 1/2	156 x 5/8
.0047	156 x 1/2	156 x 1/2	186 x 5/8
.01	156 x 1/2	171 x 5/8	250 x 5/8
.047	234 x 3/4	296 x 3/4	343 x 7/8
.1	281 x 7/8	375 x 7/8	421 x 1
.47	468 x 1 1/4	546 x 1 1/4	671 x 1 5/8

Insulation Resistance vs. Temperature

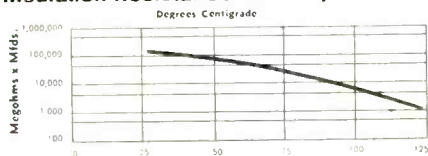

Capacitance Change vs. Temperature

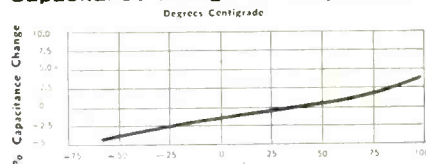

Our engineers are ready to work with you on special applications. Write or wire for specifications and quotations.



GOOD-ALL ELECTRIC MFG. CO. • OCALLALA, NEBRASKA

A leading manufacturer of Tubular and Ceramic Disc Capacitors



PROTECTION

is our business, too



M06B-1

Frequency.....400 cycles
Phasesingle
Voltage115
Capacitor2 mfd
Air Delivery.....5 cfm at
0' static pressure

The best "penny-a-month" insurance against damage to costly equipment, as well as losses through operative failures, is often a high-specification Air-Marine Motors fan, motor, or blower.

Performance . . . Dependability . . . Adaptability . . . these are the inherent characteristics of all Air-Marine Motors' rotating equipment.

When your requirements call for sub-fractional hp fans, motors or blowers, be sure to get in touch with the nation's leading specialist-manufacturer of this type equipment . . . and use the Air-Marine advisory services without obligation.



air-marine motors, inc.

369 Bayview Avenue

Amityville, N. Y.

West Coast Factory: 2055 Pontius Avenue

Los Angeles 25, Calif.



of maintenance of the unit.

The tester enables adjustment in direct-reading calibrations to compensate for temperature variations. An external jack permits collector waveform observation. Positive meter overload protection is built into the instrument.

The unit measures 5½ in. wide, 5½ in. deep and 10 in. high. Weight is three lb. Further information is available from the company. Circle P12 inside back cover.



TRANSISTOR RELAY actuated by 12- μ a input

FISHER SCIENTIFIC Co., 717 Forbes St., Pittsburgh, Pa. Model 30 transistor relay is to be used wherever one requires a sensitive apparatus to control bath or oven temperatures, maintain liquid levels, with a monitoring photocell, or for the many chores where only a small amount of power is available to control a relatively large load in laboratory, pilot plant or industrial control. The relay will complete at least a million contacts with any resistive load up to four amperes under these conditions.

The model 30 uses three germanium junction transistors. It controls a load of as much as 1,100 w with a signal as small as five millionths of a watt—actually a power gain of 220 million times.

► Features—As little as 12- μ a input actuates it. No warmup is necessary and it can't overheat. It can be used with any combination of normally closed or normally open input circuits and normally off or normally on outputs. It will handle resistive loads of up to 10 amperes for short periods. It is compact, rugged,

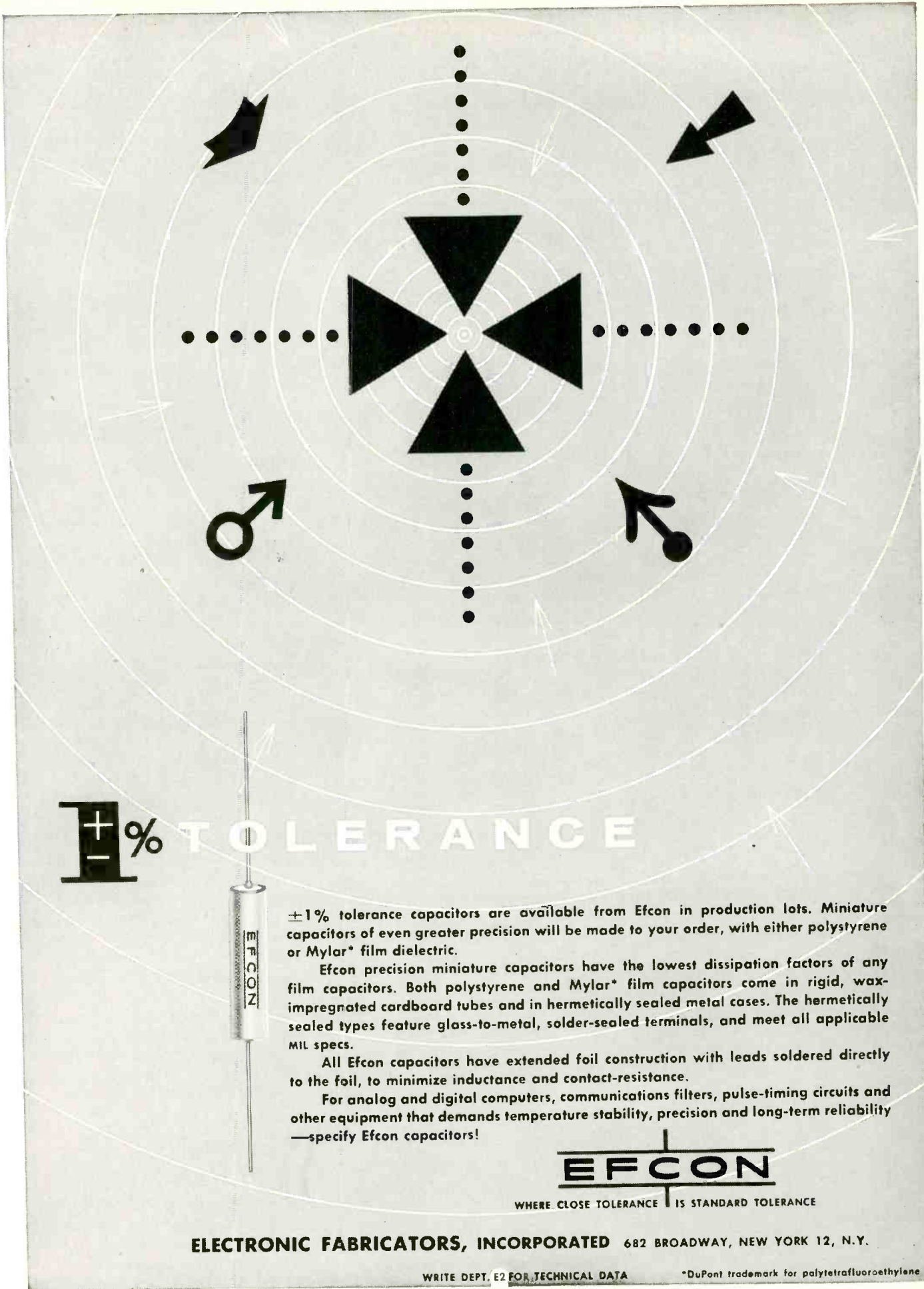

±1% TOLERANCE



±1% tolerance capacitors are available from Efcon in production lots. Miniature capacitors of even greater precision will be made to your order, with either polystyrene or Mylar* film dielectric.

Efcon precision miniature capacitors have the lowest dissipation factors of any film capacitors. Both polystyrene and Mylar* film capacitors come in rigid, wax-impregnated cardboard tubes and in hermetically sealed metal cases. The hermetically sealed types feature glass-to-metal, solder-sealed terminals, and meet all applicable MIL specs.

All Efcon capacitors have extended foil construction with leads soldered directly to the foil, to minimize inductance and contact-resistance.

For analog and digital computers, communications filters, pulse-timing circuits and other equipment that demands temperature stability, precision and long-term reliability—specify Efcon capacitors!

EFCON

WHERE CLOSE TOLERANCE IS STANDARD TOLERANCE

ELECTRONIC FABRICATORS, INCORPORATED 682 BROADWAY, NEW YORK 12, N.Y.

WRITE DEPT. E2 FOR TECHNICAL DATA

*DuPont trademark for polytetrafluoroethylene

ENGINEERS & PHYSICISTS *Electronics*

The Johns Hopkins University Applied Physics Laboratory

ANNOUNCES

... important openings on our guided missile research and development staff for men who wish to identify themselves with an organization whose prime purpose is scientific advancement.

Because the Applied Physics Laboratory (APL) exists to make rapid strides in science and technology, staff members require and receive freedom to inquire, to experiment, to pursue tangential paths of thought. Such freedoms are responsible for findings that frequently touch off a chain reaction of creativity throughout the organization.

As a staff member of APL you will be encouraged to determine your own goals and to set your own working schedule. You will associate with leaders in many fields, all bent on solving problems of exceptional scope and complexity. The resources of our 350,000 sq. ft. laboratory are complemented by those of the 18 universities and industrial organizations who are working under our technical direction on prime contracts.

Equidistant between Baltimore, Md., and Washington, D. C., our new laboratory allows staff members to enjoy suburban or urban living and the rich cultural, educational and research facilities offered by both cities.

Openings Exist In These Fields:

ANALYSIS: *Dynamic analysis of closed-loop control systems; analysis and synthesis of guidance systems; counter-counter-measures systems; electrical noise and interference.*

DESIGN: *Control and guidance circuitry; telemetering and data-processing equipment; microwave components, antennas, and radomes; transistor and magamp applications; external missile systems.*

TEST: *Prototype engineering and field test evaluation.*

SEND NOW FOR OUR NEW 30-PAGE PUBLICATION DESCRIBING IN DETAIL THE SCOPE OF THE LABORATORY'S PROGRAMS AND THE UNIQUE ENVIRONMENT IN WHICH STAFF MEMBERS WORK AND LIVE.

WRITE:

Professional Staff Appointments
The Johns Hopkins University
APPLIED PHYSICS LABORATORY
8609 Georgia Avenue • Silver Spring, Maryland

NEW PRODUCTS

(continued)

safe and convenient. **Circle P13** inside back cover.



POWER SUPPLIES for high-power klystrons

LEVINTHAL ELECTRONIC PRODUCTS, INC., 2760 Fair Oaks Ave., Redwood City, Calif. Model PC33 power supply provides continuously variable voltage from 0 to 30 kv at currents from 0 to two amperes d-c. Voltage ripple is less than 0.04 percent. Included are facilities to monitor output voltage and current; and for klystron operation, collector current and body current.

The unit is completely interlocked and overvoltage and overcurrent protection are provided. The supply can be connected to the external interlock system of associated equipment. Power input is 208 v, three phase, 60 cps.

A similar unit, the model PC44, is used for bombarded-cathode applications and provides voltages from 0 to 3 kv at currents up to six amperes with motor-driven Powerstat control. The unit utilizes air-cooled selenium rectifier stacks. Power input is 230 v, three phase, 60 cps. Internal and external interlocks are provided. **Circle P14** inside back cover.

RECORDER

two-pen, two-zone instrument

WESTON ELECTRICAL INSTRUMENT CORP., Newark 12, N. J. A new two-pen-two-zone recording instrument, ideal for comparative measurement in both the laboratory and

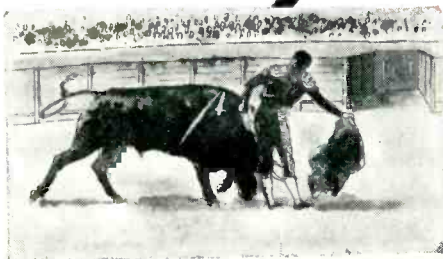
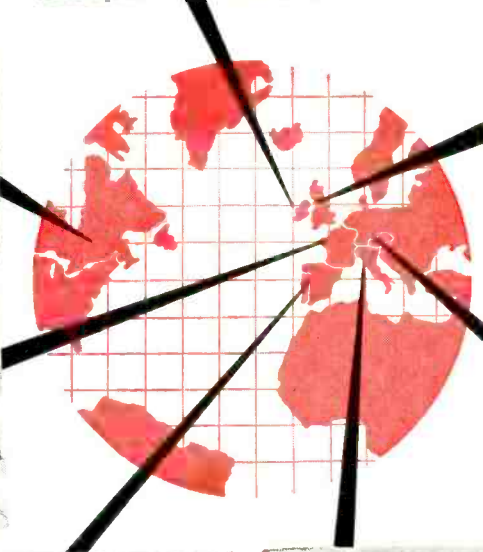
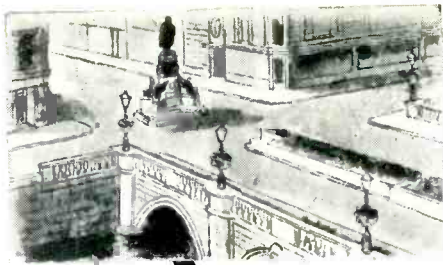

Here, too, we make Nichrome*

Perhaps you didn't know that the world-famous alloy Nichrome is produced not only in The United States, but also in 6 Driver-Harris plants in England, Ireland, France, Italy, Austria, Spain, and in Canada by The B. Greening Wire Company. Also, Nichrome is a registered trade-mark in 55 nations.

At first, fifty-odd years ago, we manufactured electrical resistance alloys for furnace elements and domestic

heating appliances only. Today we produce 132 different high nickel alloys in many different forms and in hundreds of sizes, for almost every kind of domestic and industrial application—of which Nichrome is the most illustrious.

Whenever you buy Nichrome, you are assured of the unsurpassed and unvarying *quality* which has made Nichrome the supreme world standard for electrical-resistance and heat-

resistant alloys. This uniformly high quality, which we jealously guard as our most priceless possession, results from the technical excellence, the productive skill, and the quality controls the Driver-Harris craftsmen have gained in over 50 years of experience — and which are maintained with equal rigor in all Driver-Harris plants here and abroad. The result is a continuous benefit to the entire electrical, electronic, and heat-treating industries.

*T.M. Reg. U. S. Pat. Off.



Nichrome is made only by

Driver-Harris COMPANY

HARRISON, NEW JERSEY

Manufacturing plants also in: ENGLAND • CANADA • IRELAND • FRANCE • ITALY • AUSTRIA • SPAIN

MAKERS OF THE MOST COMPLETE LINE OF ALLOYS FOR THE ELECTRICAL, ELECTRONIC, AND HEAT-TREATING INDUSTRIES

PANELSCOPE

by

Waterman

Booth Nos. 1902 and 1904.

**AUTOMATIC
OR MULTI-PURPOSE
PORTRAYAL**



ANOTHER EXAMPLE OF *Waterman* PIONEERING...

The Waterman PANELSCOPE is a new concept in miniaturized built-in cathode ray tube oscilloscope gaining wide use as an integral part of electronic equipment. A unique design has permitted its use in commercial products, factory test stands, field trouble shooting kits, system monitors and many other applications.

The PANELSCOPE compactness (5¼" x 5-3/16" and 10" depth at 5 lbs.) is coupled with the following features:

- **SIMPLICITY OF OPERATION** — Can be supplied so that a twist of a single rotary switch provides a synchronized pattern of desired incoming signal (up to 9 circuits) against proper linear time base. This is ideal for monitoring and trouble shooting, as it removes the need of fiddling with knobs as is done now on general purpose oscilloscopes. The static controls, such as beam, focus, positioning, and graticule brightness, are located in tube escutcheon.
- **AVAILABLE CIRCUITS** — A wide variety of — signal amplifiers with response from dc to megacycles and sensitivities from 5 millivolts — synchronized or triggered linear time base generators from ½-cycle (and lower if need be) to 2 microseconds — can be specified by you to fit your needs for any particular equipment.
- **FLEXIBLE DESIGN** — The basic PANELSCOPE consists of the cathode ray tube and high voltage supply packaged in the standard case without the panel mounted controls. The PANELSCOPE can also be supplied fully wired and tested with chosen signal amplifier, linear time base generator and attendant sync. amplifier.
- **POWER REQUIREMENT** — Less than 10 watts of line power for built-in high voltage supply — The required B+ and heater current is determined by your requirements. For those cases where B+ and heater power is not available, auxiliary PANELPACK can be supplied.

There is a place in your equipment for Waterman PANELSCOPE, a custom built oscilloscope at production prices, although your needs may be for but one or many. A Waterman representative will help you fit a Panelscope to your requirements.

WATERMAN PRODUCTS CO., INC.

PHILADELPHIA 25, PA.
CABLE ADDRESS: POKESCOPE

MANUFACTURERS OF

POCKETSCOPE*

PULSESCOPE*

RAKSCOPE*

RAYONIC* Cathode Ray Tubes
and Other Associated Equipment

*T.M. REG.



WATERMAN PRODUCTS

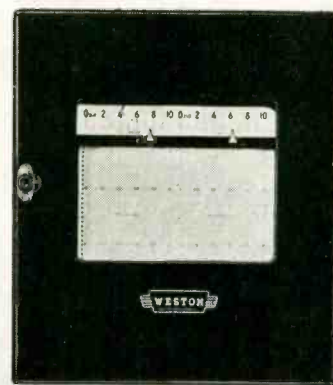

on the production line, is now included in the model 6700 line of recording-controlling instruments. While the model 6791 type 1 recorder is actually two independent instruments in one, it is housed in a case measuring only 17½ in. wide to fit standard relay racks and is of simplified, unitized construction.

It employs two electronic amplifiers of special plug-in type for easy servicing. Two separate measuring circuits with replaceable range standards permit quick range change on either one or both zones as desired. Alarm switches are available for each zone and can be set in a matter of seconds. Slide wires are interchangeable and totally enclosed for complete protection. Chart speeds are available from one in. per hour to one in. per minute. **Circle P15 inside back cover.**

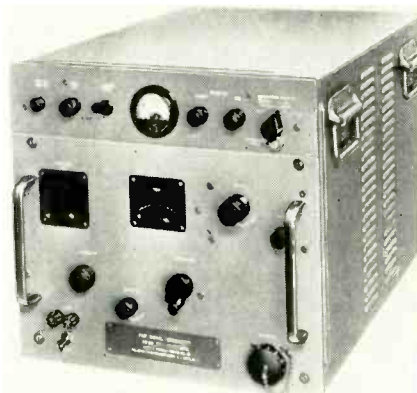

MICROWAVE GENERATORS

cover 18,000 to 50,000 mc

POLARAD ELECTRONICS CORP., 43-20 34th St., Long Island City 1, N. Y., has announced a new line of microwave generators and sources, covering 18,000 to 50,000 mc, util-

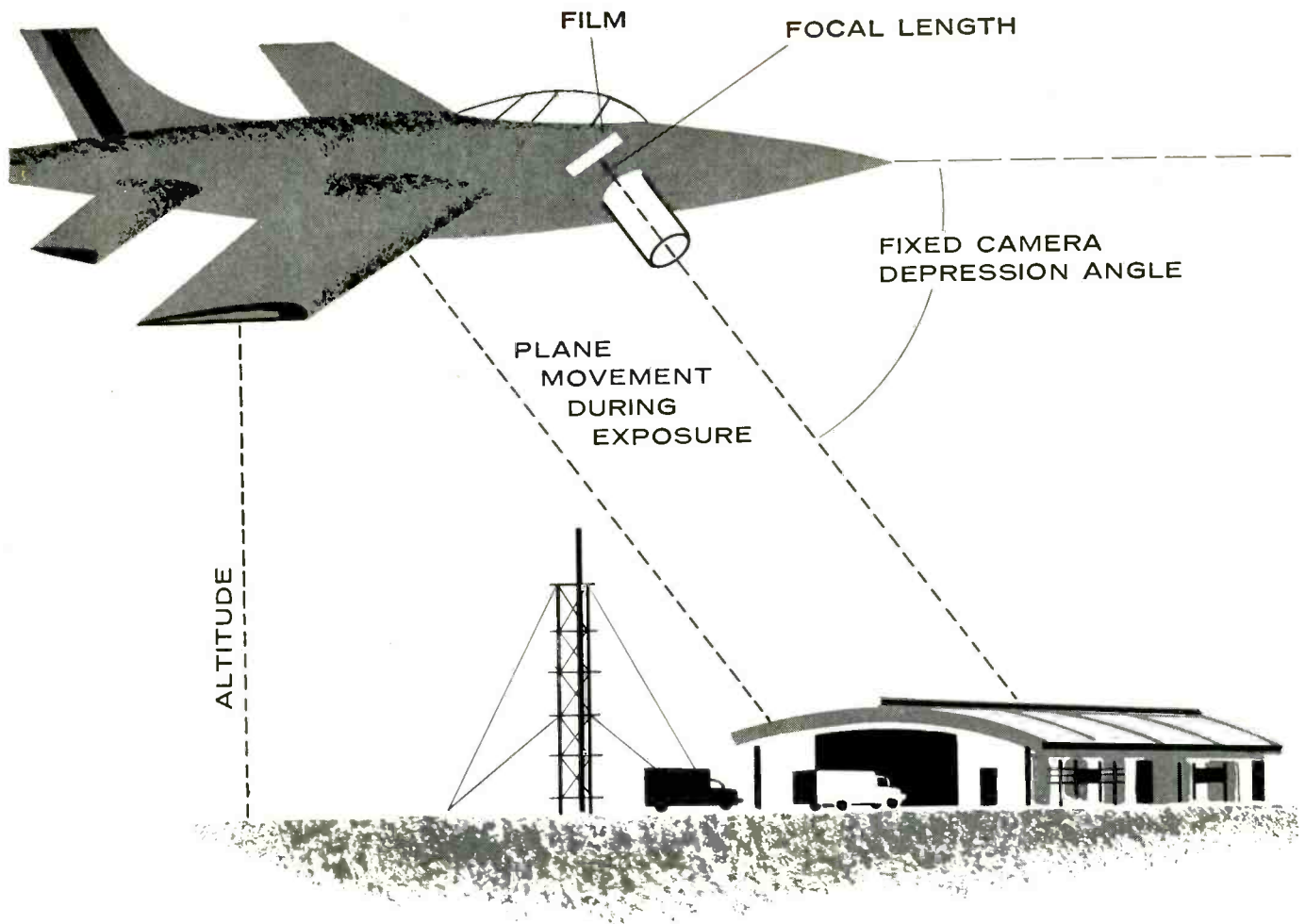

How Transicoil servos help aerial camera take clear stills even from low fast planes

It's one thing to take a picture of a moving object. But it's quite another to get good clear shots of the ground from low altitude aircraft moving at today's jet speeds. Universal Camera Control System (UCCS) is the latest development in aerial reconnaissance and photography to solve this problem. Designed and engineered by the Bill Jack Scientific Instrument Co., this novel system actually moves the film through the camera to compensate for image movement during the brief exposure time.

Accuracy of the system is dependent on the airborne DC analog computer having absolute dependability and precision under all the environmental conditions of aircraft

flight. Extremes of altitude, temperature and vibration cannot impair its effectiveness.

Transicoil servo assemblies are used extensively in the computer to convert inputs of altitude, ground speed, camera depression angle, and focal length into the correct "film movement" signal.

The UCCS application is typical of the way Transicoil rotating components and complete servo assemblies are achieving high orders of accuracy and dependability in countless applications. Transicoil can solve your servo problems with comparable success. A Transicoil Sales Engineer can help you to get off to a good start. A letter from you outlining your servo problem will bring him to your desk.



TRANSICOIL CORPORATION
Worcester • Montgomery County • Pennsylvania

HITEMP WIRES STAND UP ...WHERE OTHERS GIVE UP

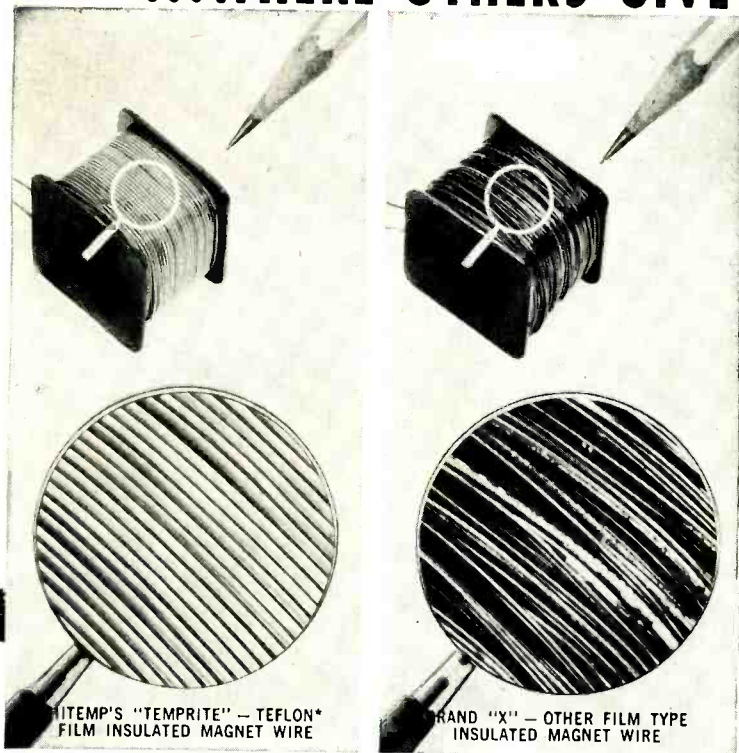

HITEMP'S "TEMPRITE" — TEFLON®
FILM INSULATED MAGNET WIRE

BRAND "X" — OTHER FILM TYPE
INSULATED MAGNET WIRE

Above photographs unretouched

IN MAGNET WIRE FOR COMPONENTS

THERMAL TEST: 168 HOURS AT 500° F.

The above illustrations clearly show the tremendous thermal advantage of Hitemp's "Temprite," Teflon® insulated magnet wire, over the best of other film-type insulations. Here is a true Class H magnet wire, with an amazing upper temperature level of 500° F.

Ask yourself! How will the component I manufacture be used? If your coils, relays, transformers, motors etc. must withstand today's high temperatures and frequencies; if moisture, chemicals or solvents will be encountered; if abrasion resistance and film continuity are a must

or if miniaturization is important... Hitemp's "Temprite" must be specified.

For maximum reliability and unequalled performance specify "Temprite" . . . the magnet wire made to exceed the requirements of military specification MIL-W-19583. Available in sizes 14 to 50 AWG inclusive and in single, heavy, triple and quadruple thicknesses.

For further information call or write your nearest Hitemp Wires, Inc. representative or sales engineer today!

Leading Specialists in High Temperature Insulations

HITEMP



WIRES

INC.

26 WINDSOR AVENUE, MINEOLA, NEW YORK

NATIONAL REPRESENTATIVE

MINNESOTA
Ken Mills
5230 Culver Road
Minneapolis, Minnesota

EXPORT
GT. BRITAIN & W. EUROPE
Hartley-Bald Ltd.
37-39 Thurloe Street
South Kensington
London S.W. 7, England

WASHINGTON, D. C.
GOVERNMENT
John W. Houston, Jr.
1625 "K" Street, N.W.
Washington 6, D. C.

NEW YORK & NEW JERSEY
Par Distributors
250 Old Country Road
Hicksville, New York

LOS ANGELES & CENT. CAL.
C. B. Rush & Associates
3757 Wilshire Blvd.
Los Angeles 5, Calif.

FLORIDA
Larry Johnson, Suite 219
561 N. E. 79th Street
Miami 38, Florida

KENTUCKY AND OHIO
Gallagher Company
15 Ritchie Avenue
Cincinnati 15, Ohio

TEXAS
General Power Equip. Co.
5823 Dyer Street
Dallas 6, Texas

ND. & SO. CAROLINA
Larco Engineering, Inc.
123 Bernard Court
Charlotte 1, N. C.

**S. CALIF., ARIZONA
AND NEW MEXICO**
Fred W. Faick Co.
2311 West Burbank Blvd.
Burbank, California

UPPER N. Y. STATE
Philip L. Kirsh
223 Windemere Road
Rochester 10, N. Y.

**CANADA, VIRGINIA, W. VA.,
MISS., LOUISIANA, PA.**
Aircinc Accessory Co.
161 Orinoco Drive
Brightwaters, N. Y.

SAN FRANCISCO & N. CAL.
Bill Kolans & Co.
3589 20th Street
San Francisco, Calif.

NEW ENGLAND
Richard H. Whitehead, Jr.
Guilford, Connecticut

**MARYLAND
AND DELAWARE**
Sol W. Goodman
32 West Biddle Street
Baltimore 1, Maryland

OREGON AND WASHINGTON
Ray Johnston Company
11009 Evanston Avenue
Seattle 33, Washington

OKLAHOMA
Joseph Turner
4140 South Pecora
Tulsa, Oklahoma

ALA., TENN. & GEORGIA
C. H. Emory Equip. Co.
P. O. Box 9013
Birmingham 9, Alabama

WRIGHT FIELD
Jack J. Carney & Assoc.
905 Knott Building
Dayton 2, Ohio

MICHIGAN
Jim Morrow Sales
85 Louise Avenue
Highland Park, Mich.

INDIANA
Richard C. Warner
Box 338
South Whitley, Ind.

ILLINOIS, WIS. & IOWA
Caine Sales Company
3029 North Eldero Ave.
Chicago 41, Illinois

*Du Pont's Trade Name for POLYTETRAFLUOROETHYLENE

NEW PRODUCTS

(continued)

izing interchangeable tuning units. Each of the tuning units requires no further adjustment to the basic unit after plug-in. The self-contained instruments provide c-w or modulated signals of known frequency for field, production line and laboratory testing of microwave equipment, components and systems. Circle P16 inside back cover.

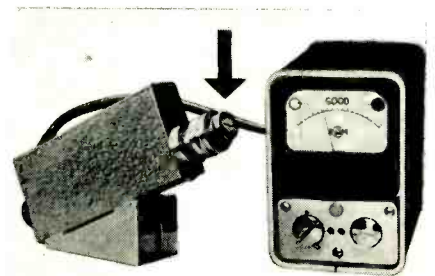

ELECTRONIC GAGE

a high-speed inspector

INDUSTRIAL GAGES CORP., West Englewood, N. J. A new high-speed electronic inspector is shown here checking the i-d of race ring. It is the LM-1 Minitron, available with a series of attachments for high speed checking of internal or external measurements of all sizes and types. The simple plug-in console can be set up for any three selections of magnification from 0.00010 per div up to 0.0001 per div. The new principle of electronics utilized guarantees positive stability of readings without regard to temperature effects and permits lower investment cost and longer life than other types supplied for similar purposes. Circle P17 inside back cover.

WIRE-WOUND RESISTOR

encapsulated, card-type

THE DAVEN Co., 530 W. Mt. Pleasant Ave., Livingston, N. J., has available a new card-type wire-wound resistor, type 1300A. The encapsulated, wafer-thin resistor is specifically designed for applications where limited space prohibits the use of the usual cylindrical bobbin types, precision wire-wound resistors. It is espe-

**Measure and plot changes
in variables as they occur...**

with

ElectroniK instruments for research

Here's an exceptional group of instruments to measure and record your research findings swiftly, surely, conveniently. These *ElectroniK* instruments for research can speed completion of your projects, by eliminating many of the tedious, time-consuming details of test work.

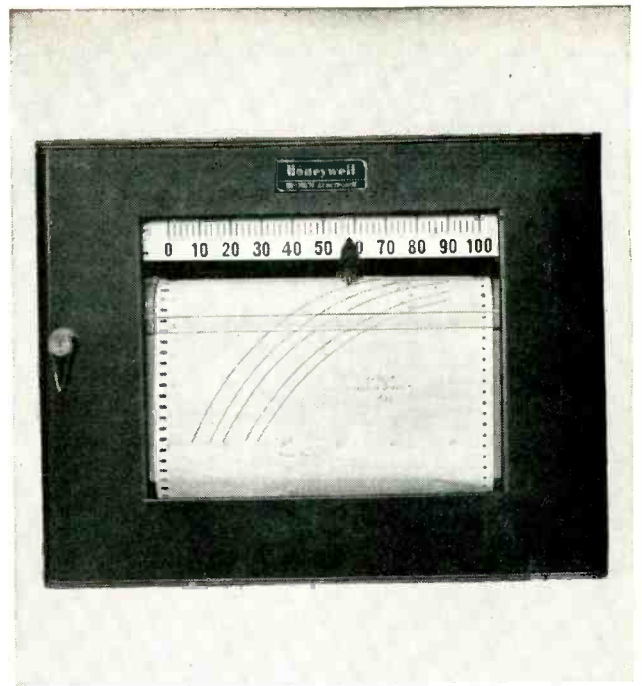

ElectroniK FUNCTION PLOTTER Automatically and continuously plots a curve which shows the relationship of one variable to another. Typical uses: speed versus torque, stress versus strain, temperature versus pressure, plate voltage versus plate current (and other electron tube characteristics), and many other variable relationships. Write for Instrumentation Data Sheet 10.0-5b.

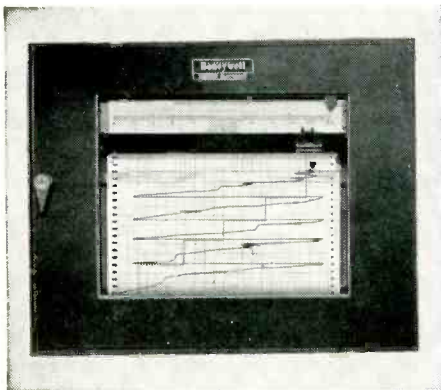

ElectroniK EXTENDED RANGE RECORDER Facilitates measurement of any linear variable whose values change over a wide range, and where precise evaluation and good resolution are important. This instrument is particularly suited to the measurement of forces in conjunction with a strain gage bridge. Write for Instrumentation Data Sheet 10.0-18.

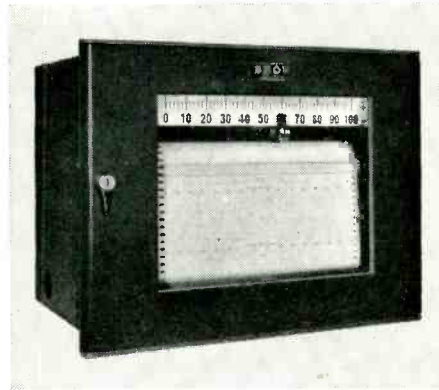

ElectroniK NARROW SPAN RECORDERS Accurately measure d-c potentials as low as 0.1 microvolt and spans as narrow as 100 microvolts. Available as a precision indicator, circular chart recorder, and strip chart recorder. Useful (with appropriate primary measuring elements) for measuring differential temperatures and slight variations in the temperatures of small objects through the use of radiation pyrometry. Write for Instrumentation Data Sheet 10.0-8.

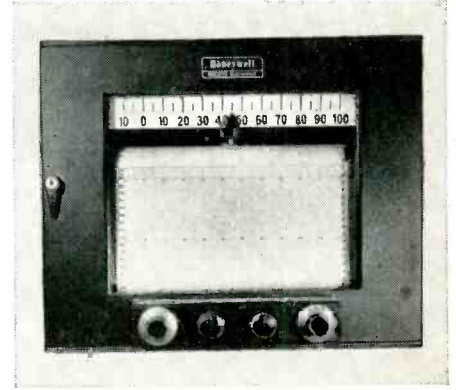

ElectroniK ADJUSTABLE SPAN RECORDER Measures spans and magnitudes of a variety of emf's. Instrument calibration can be in terms of any variable reducible to d-c voltage. Can be used with thermocouples, steam gages, tachometers, and other transducers. Write for Instrumentation Data Sheet 10.0-10a.

Your nearby Honeywell sales engineer can give you complete information about these instruments as they relate to your particular applications. Call him today . . . he's as near

as your phone. MINNEAPOLIS-HONEYWELL REGULATOR Co., Industrial Division, Wayne and Windrim Avenues, Philadelphia 44, Pa. —in Canada, Toronto 17, Ontario.



MINNEAPOLIS
Honeywell
BROWN INSTRUMENTS

First in Controls

The Ultimate in Quality Controlled Wire

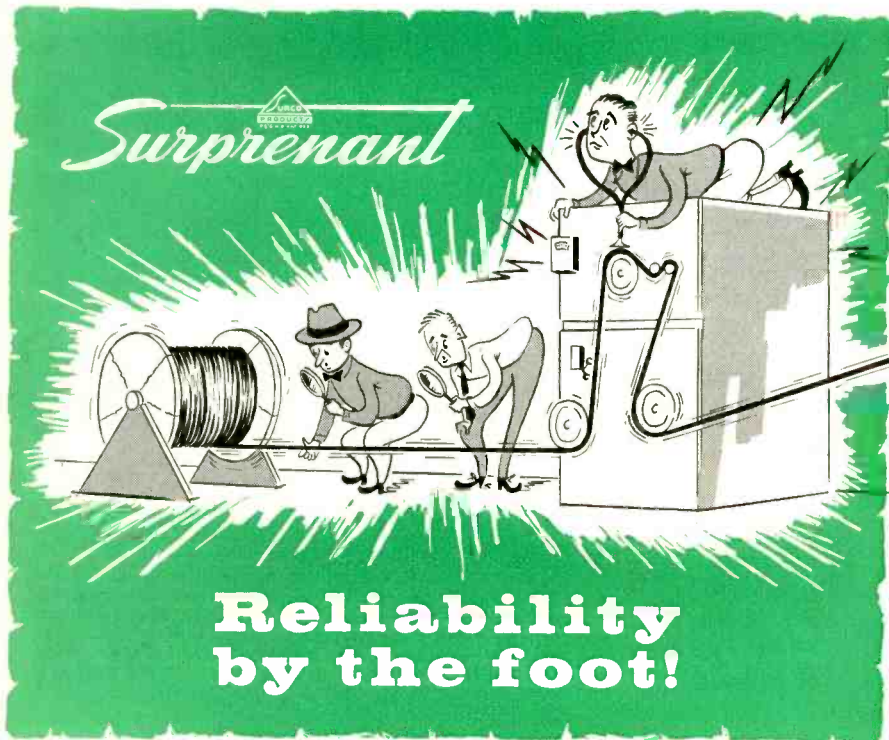

ALL RAW MATERIALS ARE BACKED BY:

- Supplier affidavits attesting to quality.
- In-plant process testing of every raw material.

ALL WIRE IS TESTED:

- Before stranding, after drawing, annealing and plating.
- After every operation in the production line.

TESTED CONTINUALLY FOR:

- Tensile strength, abrasion resistance, flammability, repeated bending, wire continuity, color, surface smoothness, diameter and dielectric failure.

PLUS HUNDREDS OF OTHER TESTING OPERATIONS

For tomorrow's wire today
look to...

Write for further information to:



Surprenant MFG. CO.

GENERAL SALES OFFICES — CLINTON, MASS.
BOSTON, MASS. NEW YORK, N.Y.

OTHER SALES OFFICES

AIRSUPPLY COMPANY

BEVERLY HILLS, CALIFORNIA
TULSA, OKLAHOMA
FORT WORTH, TEXAS
SAN DIEGO, CALIFORNIA
WICHITA, KANSAS
SEATTLE, WASHINGTON
INGLEWOOD, COLORADO
KANSAS CITY, MISSOURI
PALO ALTO, CALIFORNIA

AERO ENGINEERING COMPANY

MINEOLA, NEW YORK
BALTIMORE, MARYLAND
ATLANTA, GEORGIA
ST. LOUIS, MISSOURI
PAOLI, PENNSYLVANIA
DETROIT, MICHIGAN
HILLSIDE, ILLINOIS

D. E. HOLLINGER, W. MILTON, OHIO R. SURPRENANT, SYRACUSE 6, N. Y.
TEL.: W. MILTON 329 TEL.: SYRACUSE 730414

Engineered wire and cable for the electronics and aircraft industries

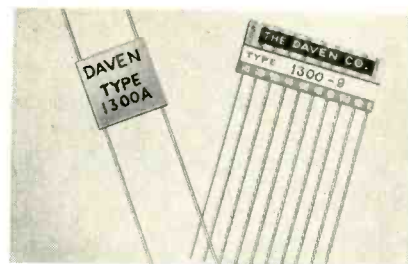

cially adaptable for circuits using transistors, in guided missiles and airborne communication and navigation equipment. Originally designed for Tinker-Toy type modules, they are also available as multisection card-type resistors. They will meet the environmental requirements of MIL-R-93A, Amendment 3.

Dimensions are $\frac{5}{8}$ in. by $\frac{5}{8}$ in. by $\frac{3}{32}$ in. (thick). Maximum resistance is 500,000 ohms. It dissipates 0.6 w. Standard tolerance is ± 1 percent. However, resistors of this type with accuracies of ± 0.1 percent may be obtained. Circle P18 inside back cover.

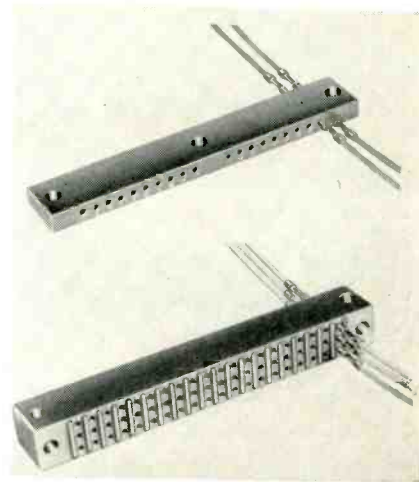

TERMINAL BLOCKS

for solderless wiring uses

DEJUR-AMSCO CORP., 45-01 Northern Blvd., Long Island City 1, N.Y. Series 145-58 taper pin terminal blocks, designed for solderless wiring applications, are fabricated in a single row of 20 contacts, in 10 dual contacts and in 10 single contacts. These may be ordered in any pair or combination of shorted contacts. Molded or eyelet holes are provided for ease of stacking and assembly.

Series 145-48 taper pin terminal blocks are fabricated in 20 rows

SKL introduces

NEW ULTRA WIDE-BAND AMPLIFIER

for fast rise pulse reproduction

320 Mc

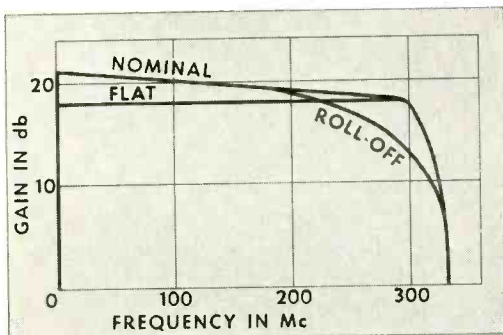

SPECIFICATIONS

Bandwidth:
300 Mc at 3 db point

Gain:
18 to 20 db depending on plug-in accessory

Rise Time:
Less than .002 μ seconds

Output:
Panel switch selects
(a) Linear: 5 volts, rms
(b) Pulse: 30 volts, negative
(c) High Pulse: Greater than 100 volts, negative, open circuit

Gain Regulation:
 ± 0.5 db for line voltage between 105 and 125 volts

Gain Control:
Panel control varies gain 6 db

Phase:
Linear to 300 Mc

Impedance:
180 ohms input, 200 ohms output

Size:
19" wide, 8 $\frac{3}{8}$ " deep, 7" high

Power Requirements:
115 volts, 60 cycles

Write for Bulletin 206

Here is another advance in the art . . . Spencer-Kennedy's new Ultra Wide Band Amplifier, Model 206. Now for the first time fast-rise-time pulses can be faithfully reproduced by providing a stable 20 db gain over a 320 Mc band! . . . Although nominal gain for Model 206 is 20 db, sloping to 18 db at 300 Mc and 14 db at 320 Mc, flat and gradual roll-off characteristics are readily available by means of small, inexpensive plug-in accessories (see curves above). Three output modes . . . linear, pulse and high pulse . . . are selectable by means of a front panel switch. Integral regulated power supply and rack mounting are also provided. Applications include amplification of the following: short fast-rise-time pulses from pulse generators, input to wide-band vacuum tube voltmeters, output of scintillation detectors, multi-channel VHF signals, wide-band IF signals, narrow band IF signals with wide range for choice of center frequency. Model 206 also serves ideally as a distribution amplifier for wide band receiving systems feeding multiple diverse channel receivers.

IRE Show — Booths 3502 and 3504

SKL

**SPENCER - KENNEDY
LABORATORIES, INC.**

1320 SOLDIERS FIELD ROAD
BOSTON 35, MASS.

SEAELECTRO "PRESS-FIT"™ subminiature TEFLON TERMINALS

SO MIGHTY...

Yes, mighty! That's why Seaelectro subminiature "Press-Fit" terminals are found in critical assemblies where failure just can't be tolerated—in guided missiles, radar, communications equipment, electronic computers, etc.

Simplest installation—just press-fit, that's it. No brittle materials or seals breaking down. Dielectric strength of 1000 to 2000 volts per mil. No carbonization from arc-over—lowest losses. Moisture condenses in droplets—no continuous film. Plus other amazing electrical characteristics matching the ideal ruggedness. Yes, mighty!



YET SO TINY...



Unbelievably so. A dozen of these subminiature stand-offs and feed-thrus fit comfortably on a quarter. Sizes from .093" to .179" bushing d.a. All due

to the proper application of Teflon, the "miracle insulator", by the pioneer and specialist—SEAELECTRO!

Get Your Copy! This handy "Press-Fit" Manual is yours for the asking. Likewise application engineering second to none, applied to your particular assemblies.

*Trademark of the original Teflon terminal manufacturer
†Reg. Trademark, E. I. Du Pont de Nemours & Co.



Seaelectro
CORPORATION

610 Fayette Avenue, Mamaroneck, N. Y.

of triple-stacked contacts arranged in any desired shorting combination. This series is supplied with perpendicular and right angle holes for mounting.

Taper receptacles are gold-plated brass over silver for low contact resistance. Bodies are molded of high-impact reinforced glass-filled Alkyd, type 440A. (Other molding materials on request). Circle P19 inside back cover.

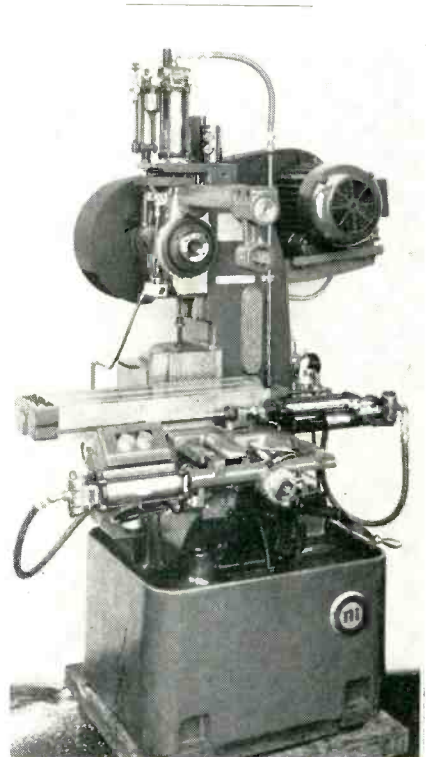

MILLING MACHINES slice germanium ingots

THE ROBERT E. MORRIS Co., West Hartford 7, Conn. Illustrated is a high-speed automatic milling machine suitable for slicing and dicing germanium ingots for the transistor manufacturing industry. These millers are of the rise and fall spindle type with speeds up to 10,000 rpm available.

Automatic mist lubrication system is provided for spindle bearings and antifriction overarm type arbor support. Diamond impregnated sawing disks up to eight-in. diameter can be accommodated. Automatic transverse feed of six in., adjustable in increments from 0.001 in. to 0.085 in., is synchronized with automatic pneumatic feeds of spindle head and table

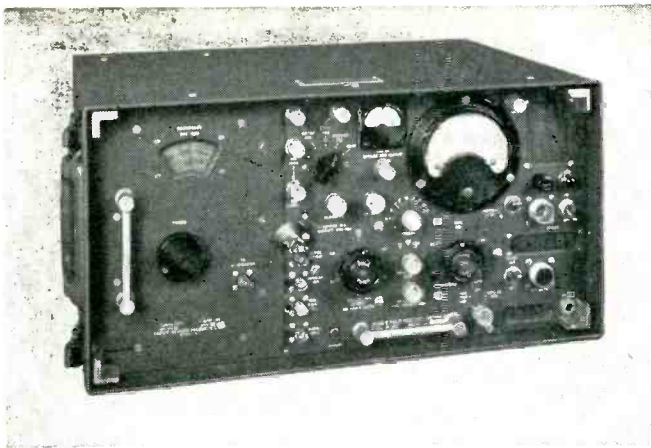

NOISE AND FIELD INTENSITY METER, Model NF-105
(Commercial equivalent of AN/URM-7) 150 KC to 1000 MC

Four quick-change tuning heads • Single knob tuning for easy scanning
Built-in impulse generator serves as calibrator • Carrier and peak reading VTVM • Aural slideback • Coaxial step attenuators • Regulated 'A' and 'B' supply.

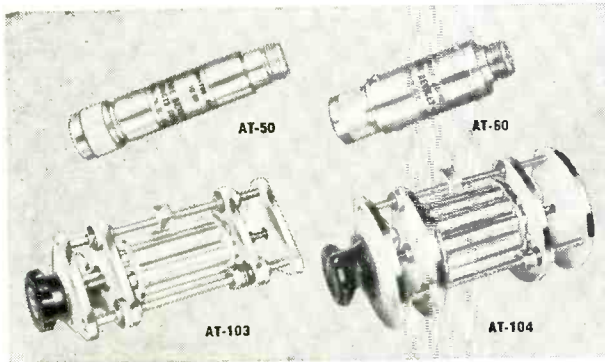

UHF ATTENUATORS, Models AT-50, AT-60

50 ohm resistive T-networks of concentric line construction.

FREQUENCY RANGE:

AT-50: DC to 4000 MC.
AT-60: DC to 3000 MC.
VSWR: Better than 1.2 at all frequencies.

ACCURACY: $\pm 1/2$ DB.

RATED POWER:

AT-50: 1W continuous
1KW peak
AT-60: 2W continuous
2KW peak

STEP ATTENUATORS, Models AT-103, AT-104

These units use AT-50 pads in 6 step and 12 step coaxial turret arrangements respectively.

COAXIAL TERMINATION, Model TE-80

1 watt, DC to 4000 MC.

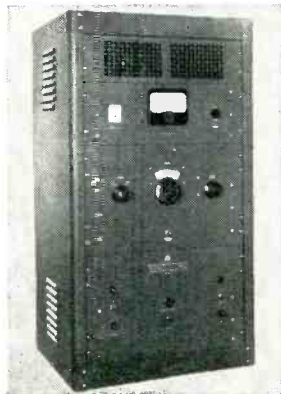

VARIABLE FREQUENCY POWER SUPPLY, Model VP-400

POWER OUTPUT: 500 watts
VOLTAGE REGULATION: 2%, no load to full load
HARMONIC DISTORTION: 5% maximum, total, (to 400W).

*Empire's
Reputation
is built on
Quality*

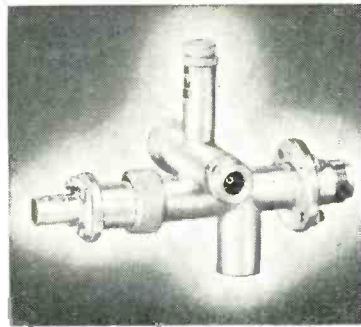

COAXIAL CRYSTAL MIXER, Model CM-107

Broad Band, Fixed Tuned • 225 MC to 5600 MC in 8 models • Input and L.O. VSWR better than 2 to 1 • L.O. rejection at IF output better than 30 DB.

CRYSTAL DETECTOR, Model DT-123

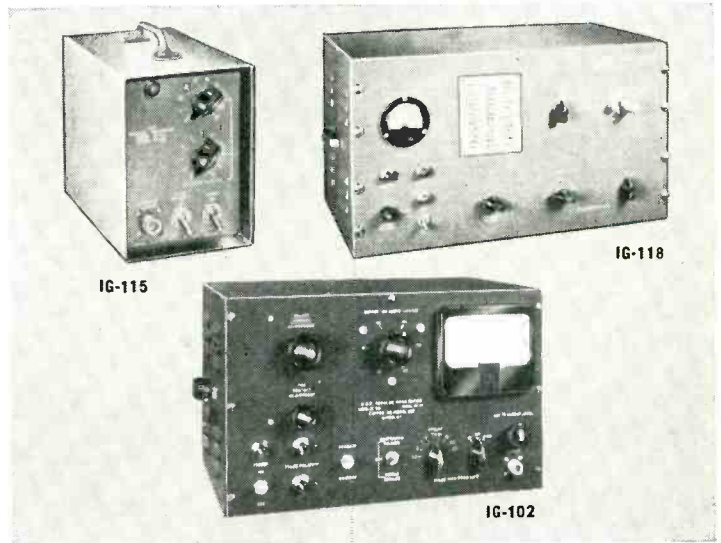

UHF IMPULSE GENERATORS, Models IG-102, IG-115, IG-118

Model	Flat Spectrum ($\pm 1/2$ DB)	Peak Output Level	Repetition Rate
IG-102	10 KC to 1000 MC	70,000 μ V/MC	2.5 to 2500 cycles
IG-115	10 KC to 1000 MC	100,000 μ V/MC	60 cycles
IG-118	100 MC to 10,000 MC	9,000 μ V/MC	2.5 to 2500 cycles

POWER DIVIDERS, Model PD-90

FREQUENCY RANGE: 800 to 10,000 MC in 5 models,



For complete engineering data, please send for our new Catalog No. 357

EMPIRE DEVICES PRODUCTS CORPORATION
38-15 BELL BOULEVARD, BAYSIDE 61, NEW YORK
Manufacturers of FIELD INTENSITY METERS • DISTORTION ANALYZERS • IMPULSE GENERATORS
COAXIAL ATTENUATORS • CRYSTAL MIXERS

Visit our booths 3818 - 20, Third Floor, at the IRE Show.

for high-speed continuous slicing cycles. Circle P20 inside back cover.

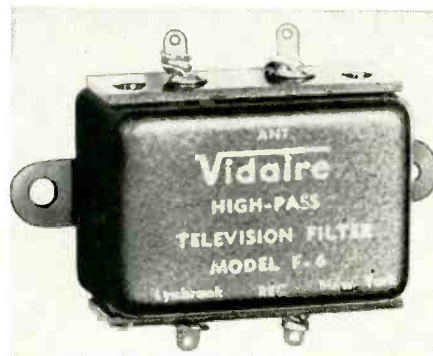

HIGH-PASS TV FILTER

is completely shielded

VIDAIRE ELECTRONICS MFG. CORP., 576 W. Merrick Rd., Lynbrook, N. Y. Model F-6 high-pass tv filter is designed to cut off below 50 mc. It will reduce or eliminate most interference in the 21-mc or 41-mc tv i-f bands. It is completely shielded eliminating the possibility of any stray pickup by the filter itself. Only $1\frac{1}{2}$ by $1\frac{1}{2}$ by $\frac{3}{8}$ in. in size, the F-6 has mounting tabs for simple mounting right at the tv tuner. High-efficiency coils and ceramic capacitors are used throughout, making the F-6 an effective rejection device for the unwanted frequencies. Circle P21 inside back cover.



COMMUTATOR

two-pole telemetering type

INSTRUMENT DEVELOPMENT LABORATORIES, INC., 67 Mechanic St., Attleboro, Mass., announces a new

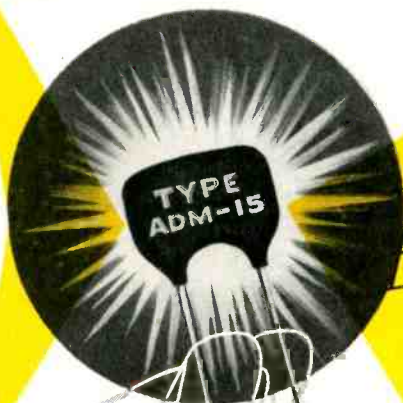

AEROVOX

Plastic-Coated

DIPPED-MICA CAPACITORS

Greater Stability

with *New Versatility!*

Now... from Aerovox! Plastic-coated, dipped-mica capacitors that exceed many of the advantages of molded mica units, and at the same time are smaller than conventional units.

Meeting all the applicable RETMA Test Standards for molded mica units, these unique dipped-mica capacitors offer the following outstanding features:

- ★ High operating temperature -55°C to $+125^{\circ}\text{C}$.
- ★ Excellent long-life characteristics.
- ★ Improved temperature coefficient range.
- ★ Radial-leads for automatic insertion and plug-in assemblies. Ideal for printed-wiring applications.
- ★ Reduced physical sizes.
- ★ Excellent performance and stability characteristics.

Available in a complete range of standard capacitance values in standard $\pm 10\%$ tolerance. Other values and closer tolerances supplied on request. Conventional molded mica and silvered-mica units are also available from Aerovox in a complete selection of types and sizes.

Write for descriptive literature

To serve you better... Aerovox components are stocked and sold by Aerovox Parts Distributors in all major cities.



ACTUAL SIZE



AEROVOX CORPORATION

NEW BEDFORD, MASSACHUSETTS

In Canada: AEROVOX CANADA LTD., Hamilton, Ont.

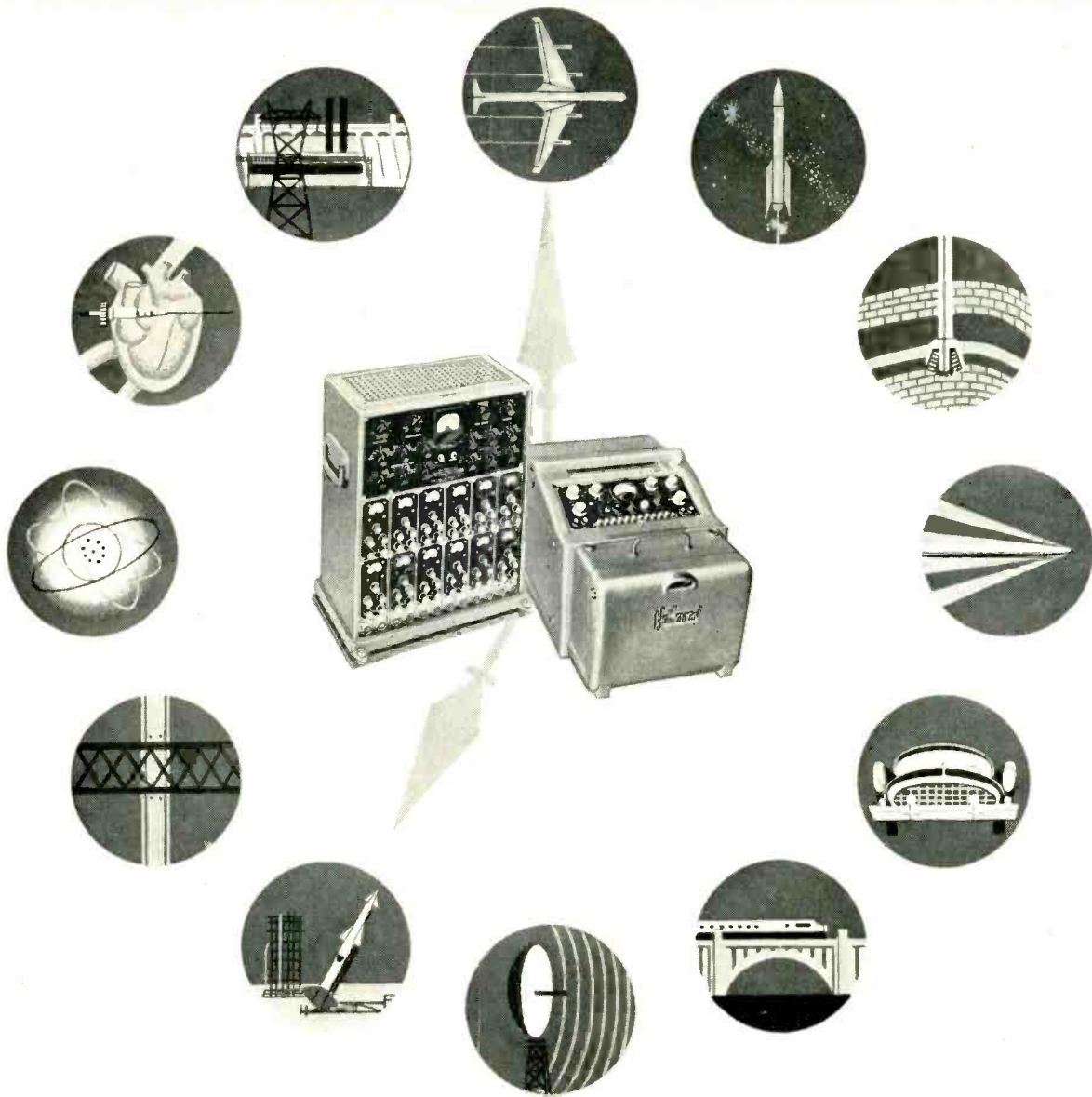

You can save valuable test and research hours with this system...

The convenient HATHAWAY MRC-21 Strain Gage Control Unit and the S-25 Oscillograph

comprise a measuring and recording system preferred by the military, industrial and research fields. Valuable engineering time is saved by the greater convenience of the system's broader range of channels, exclusive pushbutton selectivity and maximum amplification which results in clearer records.

Only Hathaway can offer you all these advantages for your instrument investment...

- up to 36 channels • 1/6 to 160 in/sec chart speeds • pushbutton convenience while operating
- up to 30,000 in/sec writing speed • remote operation • carrier or wide band amplification
- automatic calibration • 0 to 6000 cps response • 1/10 microinch/in noise level

Write for the facts you want to know—Bulletins 1-2A and 4-2A

Test with convenient, versatile



instrumentation by...

**HATHAWAY INSTRUMENT DIVISION
HAMILTON WATCH COMPANY**

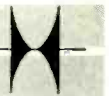

5800 EAST JEWELL AVENUE • DENVER 22, COLORADO

• NEW YORK
600 Fifth Ave.
Plaza 7-7947

• DETROIT
1900 E. Lincoln Ave.
Birmingham, Mich
Midwest 4-9004

• CHICAGO
35 E. Wacker Dr.
Stole 2-8411

• ALBUQUERQUE
3221 Silver Ave., S.E.
5-9637

• PASADENA
380 E. Green St.
Ryan 1-7829

All the unusual
qualities required
by precision
equipment

-and more!

EVANOHM*

RESISTANCE WIRE

- FOR HIGH SPECIFIC RESISTANCE
- LOW TEMPERATURE COEFFICIENT AND LOW THERMAL EMF TO COPPER
- GREAT STABILITY OVER WIDE TEMPERATURE RANGES

EVANOHM is recommended for all precision applications where complete dependability over a wide temperature range is essential. It is especially well suited for aircraft instruments, guided missiles, rockets and other airborne equipment.

EVANOHM RESISTANCE CURVE

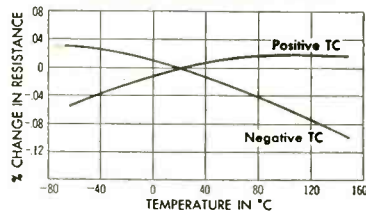

ANALYSIS — Ni 74.75%, Cr 20.00%, Al 2.75%, Cu 2.50%

CORROSION RESISTANCE — Excellent
RESISTIVITY — 800 ohms per circular mil foot (134 microhm cm.)

TEMPERATURE COEFFICIENT OF ELECTRICAL RESISTANCE — Plus or minus .00002 ohms max. per ohm per degree centigrade between -50°C . and $+150^{\circ}\text{C}$.

THERMAL E.M.F. VS. COPPER — .0025 mv. per deg. between -50° and $+105^{\circ}\text{C}$. (max.)

NON-MAGNETIC

HIGH TENSILE STRENGTH IN FINE SIZES — 150,000 to 200,000 p.s.i.

WORKABILITY — May be readily welded or brazed and soft soldered with special care.

AVAILABLE IN: (A) Bare wire .0005 and heavier. (B) Enamelled .0179 and finer. (C) Formex .0008 to .0113. (D) Silk, cotton, nylon and glass .0179 to .0015.

EVANOHM*

a patented, exclusive alloy produced by



**WILBUR B.
DRIVER CO.**

NEWARK 4, NEW JERSEY

*Registered Trade Name

See us at the
I.R.E. Show!
Booths
4202-4204

telemetering commutator with a life expectancy exceeding 500 hr without servicing. It is contained in a hermetically sealed case to overcome most of the usual military environmental conditions. Powered by a 400-cps, 115-v, two-phase motor, this unit requires only seven w to provide 10 rps pole speeds and only 15 w for 30 rps pole speeds.

Contact resistances of less than 0.25 ohm are practically invariant during the entire use of the commutator. Intercontact impedances exceed 100 megohms for the life of the instrument.

Measuring only $2\frac{1}{2}$ in. in diameter by $5\frac{3}{4}$ in. long, this two-pole unit has exceeded 1,000 hr life at 10 rps and has withstood 2,000-cps vibration frequencies at 16-g. amplitude. Circle P22 inside back cover.

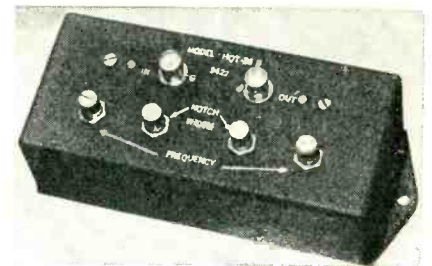

REJECTION FILTERS

feature narrow bandwidth

ENTRON INC., 4902 Lawrence St., Bladensburg, Md. The HQ series are extremely stable, sharp-cutoff, high-attenuation, vhf band-reject filters. They have a wide tuning range and constant bandwidth. The units afford an easy means of improving band edge response of broad-band filters or amplifiers. Their narrow bandwidth allows them to be used to eliminate narrow-band cochannel interference. These traps are particularly well suited for removing adjacent channel interference to color tv signals.

► **Bandwidth Ranges**—The HQT has a peak attenuation greater than 70 db and a 30-db bandwidth of 200kc. The HQF has a peak attenuation greater than 90 db and a 30-db bandwidth of 400 kc. They are available with various connector types, matched to main-

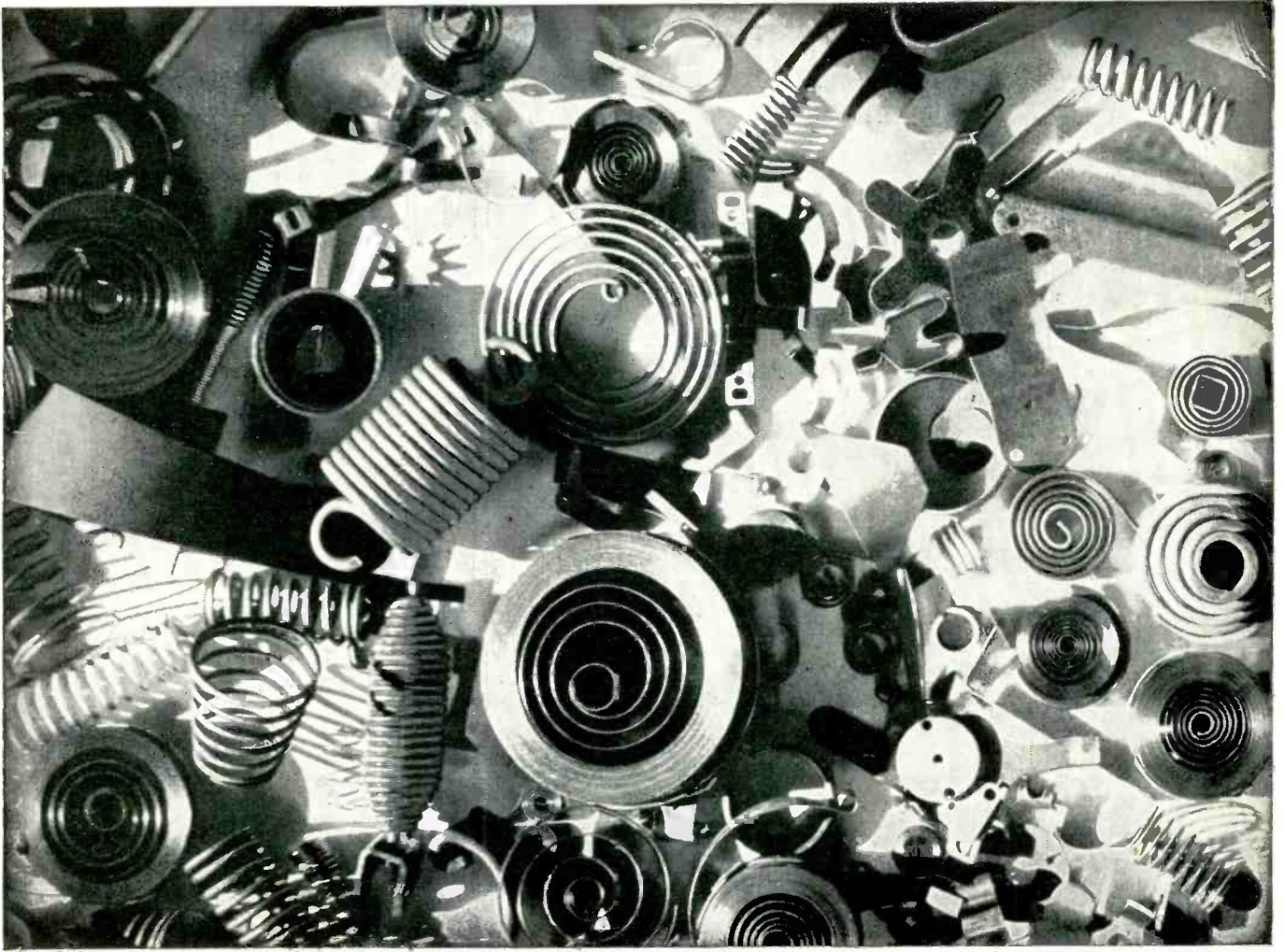

Photo courtesy of Associated Spring Corp.

Need a spring for service above 500° F.?

When it is a question of strength and resistance to fatigue and relaxation under corrosive conditions —

Particularly when temperatures range over 500°F. and other materials do not perform satisfactorily —

That is the time to see how INCO Nickel Alloys may solve the problem for you.

The alloys, Inconel and Duranickel, for example, are widely used for springs that must resist relaxation at stresses up to 70,000 psi and temperatures up to 650°F.

Inconel "X" alloy goes even further. It maintains 90 per cent of its room-temperature mechanical properties up to 900°F., 80 per cent up to 1100°F. Combines excellent resistance to heat, corrosion, and *relaxation* at stresses up to 100,000 psi. (Maximum recommended de-

sign stress, corrected, decreases as heat exceeds 700°F.)

Other Inco Nickel Alloys—Monel, "K" Monel, Permanickel—help solve special spring problems. Permanickel alloy, for example, combines good electrical conductivity with excellent heat and fatigue resistance.

Why don't you let Inco engineers help you find the right spring for severe service.



Nickel Alloys

MONEL® • "R"® MONEL • "K"® MONEL • "KR"® MONEL
 "S"® MONEL • INCONEL® • INCONEL "X"® • INCONEL "W"®
 INCOLOY® • NIMONIC® Alloys • NICKEL
 LOW CARBON NICKEL • DURANICKEL® • PERMANICKEL®

THE INTERNATIONAL NICKEL COMPANY, INC.

Electrical and Electronic Section
 67 Wall Street, New York 5, N. Y.

E-3-57

Please send me information on:

1. Springs for use at _____°F.
2. Names of manufacturers of Inco Nickel Alloy springs.

Name _____ Title _____

Company _____

Company Address _____

Product _____

Lightweight! SERVO Magnetic Amplifiers

The servo amplifiers illustrated are typical standard types. Other models, including higher power types, are available for systems engineering. The complete MA line offers the designer a choice of compact, low cost types, amplifiers featuring fast response at high gain and all-magnetic models providing highest performance.

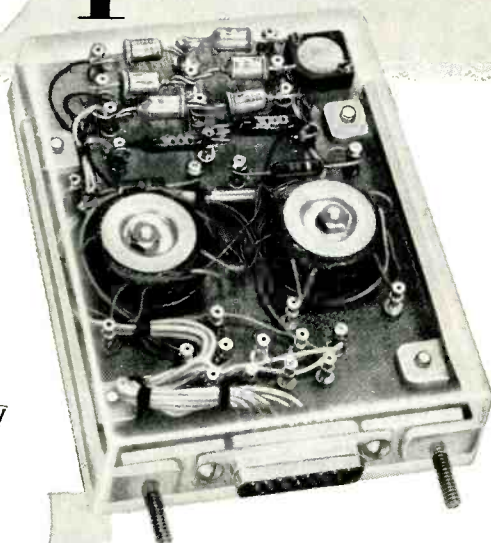

In addition to standard types, custom designs can be produced for special applications, or complete servo and automatic control systems can be engineered to your requirements.

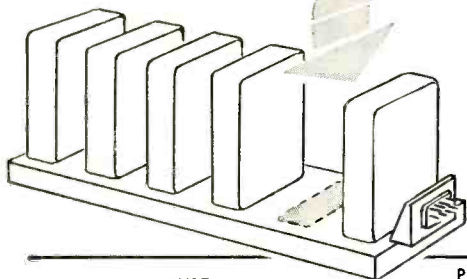

TYPE	SUPPLY	POWER OUTPUT	SENSI-TIVITY	RESPONSE TIME-SEC.
LIGHTWEIGHT SUB-MINIATURE MAGNETIC AMPLIFIER	115 volts 400 cps.	½, 3, 5, 10 watts	.02 volts	.003
MAGNETIC PRE-AMP + SATURABLE TRANSFORMERS	115 volts 400 cps.	3, 5, 6, 10, 18 watts	1 volt AC	.03
MAGNETIC PRE-AMP + HIGH GAIN MAGNETIC AMPLIFIER	115 volts 400 cps.	5, 10, 15, 20 watts	0.1 volt AC	.008 to .1
TRANSI-MAG*: TRANSISTOR + HIGH GAIN MAGNETIC AMPLIFIER	115 volts 400 or 60 cps.	2, 5, 10, 15, 20 watts	.08 volt AC into 10,000 ohms	.01

Call or write for new illustrated bulletins.

Magnetic Amplifiers • Inc
632 TINTON AVE., NEW YORK 55, N. Y.—CYpress 2-6610
West Coast Division
136 WASHINGTON ST., EL SEGUNDO, CALIF.—EAsgate 2-2056



SEE US AT THE I.R.E. SHOW! BOOTH 1433

tain minimum vswr.

Current models HQT-26 and HQF-26 are tunable in the range of 50 mc to 100 mc and model HQT-73 is tunable in the range of 174 to 220 mc. Circle P23 inside back cover.

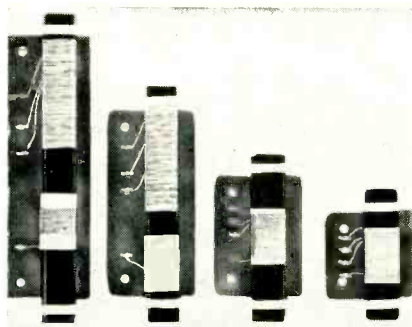

ANTENNA STICKS for transistor receivers

SUPEREX ELECTRONICS CORP., 4 Radford Place, Yonkers, N. Y. Eleven different transistor-matched Loopsticks are now available. Features include complete electrical adjustability, compactness, maximum signal transfer and increased selectivity.

Each Loopstick is packed with full installation instructions including nine suggested circuits and a summary of transistor receiver design. A descriptive catalog is available. Circle P24 inside back cover.

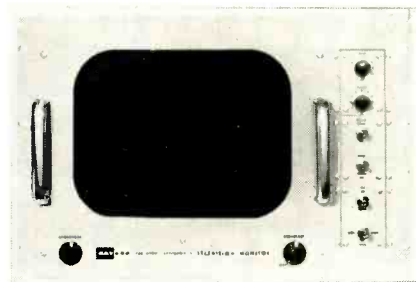

VIDEO MONITOR for closed circuit use

KAY LAB, 5725 Kearny Villa Road, San Diego 11, Calif. Model ARM-14 is a new 14-in. video monitor designed to provide remote viewing of video information from the company's industrial or broadcast tv camera chains. It contains a precision deflection system and a broadband video amplifier that

looking for a "POT"?



THREE OF THE MANY "MULTIPOTS" IMMEDIATELY AVAILABLE. (All models available in 1, 3, 5 and 10 turn, and wide range of resistance values.)



MODEL "RU"
Standard 1 1/8" diameter with 4 watt power, maximum resistance and resolution.



MODEL "D"
1" diameter and minimum length.



MODEL "DH"
Sealed and metal clad for operation under adverse humidity and vibration.



FORD "MULTIPOTS" by DAYSTROM PACIFIC CORPORATION

Wire-wound, Precision-built, Multi-turn Potentiometers WITH:

- HIGH RESOLUTION
- CLOSE LINEARITY
- EXCELLENT PERFORMANCE UNDER EXTREME VIBRATION

The Ford Engineering Company, Inc. "Multipots" compliment the many precision-built, wire-wound, sub-miniature potentiometers already produced by Daystrom Pacific Corporation, so that Daystrom now can fill all of your potentiometer needs with top-quality production model potentiometers.

ALL FORD "MULTIPOTS" IMMEDIATELY AVAILABLE

WRITE TODAY FOR DETAILS

DAYSTROM PACIFIC CORPORATION

A Subsidiary of Daystrom, Inc.

DIVISIONS: AMERICAN GYRO
DAYSTROM POTENTIOMETER

3030 NEBRASKA AVENUE, SANTA MONICA, CALIFORNIA

Remember D for Daystrom, Daystrom for Dependability

QUALITY INSTRUMENTS FOR PRECISION TESTING OF *Tomorrow's Circuitry*

SG-25 STANDARD SIGNAL GENERATOR

Equivalent to AN/URM-25D. For alignment of radio receivers, measurements of receiver sensitivity and selectivity, and in all radio frequency voltage measurement work.

- Frequency Range: 10 KC to 50 MC in 8 bands
- Calibrated Output: 0.1 to 100,000 microvolts into 50 ohms
- High Output: 2.0 volts, 500 ohms impedance



SG-26 STANDARD SIGNAL GENERATOR

Equivalent to AN/URM-26B. For alignment of radio receivers, measurements of receiver sensitivity and selectivity, and in all radio frequency voltage measurement work.

- Frequency Range: 4 to 405 MC in 6 bands
- Calibrated Output: 0.1 to 100,000 microvolts into 50 ohms
- Output Impedance: 50 ohms nominal

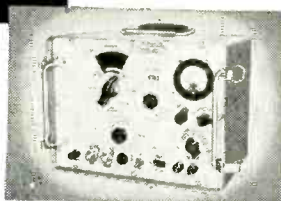

RT-500 RECEIVER-TRANSMITTER TESTER

Equivalent to AN/TRM-1. Laboratory-quality portable instrument, designed to measure performance on transmitting and receiving equipment.

- Frequency Range: 190 KC to 400 MC
- Signal Generator Output: 2.5 to 100,000 microvolts into 50 ohms
- Transmitter Tester Power Range: 3 to 100 watts
- Volt/Milliwatt Meter: multi-range meter measures AC, DC volts and milliwatts

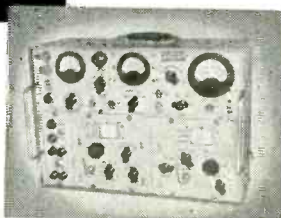

PO-400 PULSE OSCILLOSCOPE

Equivalent to AN/USM-38. Precision portable oscilloscope for analyzing amplitude and time characteristics of complex electrical waveforms.

- Transient Response: 0.06 microseconds (rise time)
- Square Wave Response: less than 5% drop at 50 cycles
- Deflection Sensitivity: 0.1V RMS per inch
- Sweep: 1 to 100,000 microseconds per inch, triggered or recurrent



AT-120 R. F. STEP ATTENUATOR

Designed for use in output systems of signal generators, precision microvolters, IF strips of microwave receivers, etc.

- Frequency Range: 0 to 1000 MC
- Attenuation Range: up to 120 db in ten steps
- Output Impedance: 50 ohms standard, 75 ohms optional
- VSWR: 1.1 up to 500 MC, 1.2 up to 1000 MC

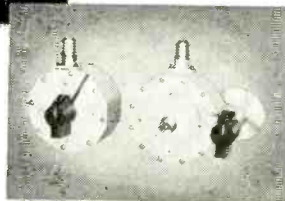

CS-200 SERIES COAXIAL SWITCHES

For all types of coaxial switching.

- Positions: up to 12
- Nominal Impedance: 50 ohms
- VSWR: 1.2 up to 500 MC, 1.3 up to 1000 MC
- Cross-talk for 12 Position: greater than 75 db down at 1000 MC



CM-300 CRYSTAL DETECTOR MOUNT

For general purpose in RF monitoring 50 or 75 ohm coaxial systems. Can be used with Trad Attenuator AT-120.

- Frequency Range: 10 to 1000 MC
- Accuracy: 1/2 db
- Impedance: available in 50, 75, 100, 150 and 225 ohms
- Maximum Signal Output: 2.5 V RMS

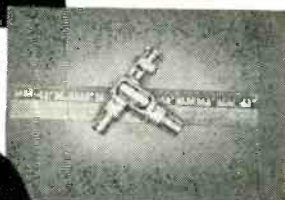

Trad has a complete, diversified line of electronic products, some of which are listed here. All products are available for speedy delivery. Trad's national representative organization is now being expanded. Interested reps may write or call George Trad at Prospect 6-7445 for appointment.

provide exceptional overall picture quality. Horizontal resolution is better than 600 lines. Only one coax cable is necessary between the camera control unit and the monitor. Sync is provided by blanking pulses on the video waveform. The monitor may be positioned up to 1,000 ft from the camera control unit without line amplifiers. The unit is available in a cabinet or a 19-in. rack mountable chassis. The rack-mount model will accept any three remote control panels for remotely controlled pan-tilt, iris-focus, three-lens turret and camera control accessories. Circle P25 inside back cover.

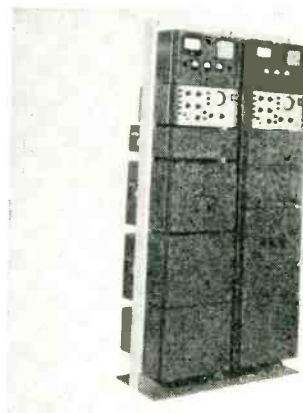

MULTIPLEX TERMINAL sixteen-channel system

RIXON ELECTRONICS, INC., Silver Spring, Md., has developed a 16-channel time-division-multiplex terminal system for use primarily with vhf communications equipment.

To increase reliability and operating efficiency, transistors, germanium diodes and magnetic storage units are utilized in many of the circuits. Plug-in module packages and printed circuits are also used extensively throughout the equipment.

The MUX-16 equipment is designed for 115-v 60-cycle operation and has a total power consumption of under 500 w. A complete system can be mounted in a dual relay rack cabinet 84 in. high. The equipment is capable of two, four, eight and 16-channel operation at teletypewriter speeds of 60, 75 and 100 wpm.

By employing oscillators with a

COMPONENTS TO SYSTEMS FROM

Mack

A DYNAMIC COMBINATION —

- MACK TRUCKS' MANUFACTURING FACILITIES
- MACK ELECTRONICS' SKILL AND EXPERIENCE

This closely coordinated team of research and mass production is a vital force in today's electronic industry. Mack's diversified electronic products are a result of imaginative, creative engineering coupled with unsurpassed research and manufacturing facilities.

Leaders in the industrial, military, medical and commercial markets turn to Mack Electronics to solve their problems in:

- COMMUNICATIONS • RADAR • COMPUTER COMPONENTS AND SYSTEMS
- CONTROLS • ULTRASONICS
- PRECISION TEST EQUIPMENT • INSTRUMENTATION
- RADIATION DETECTION EQUIPMENT • AUTOMATION



COMPUTER COMPONENTS



CARRIER FREQUENCY VOLTMETER
(WAVE ANALYZER)

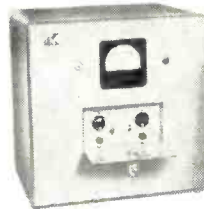

ULTRASONIC GENERATOR



AIRPORT TRAFFIC CONTROL
MONITOR

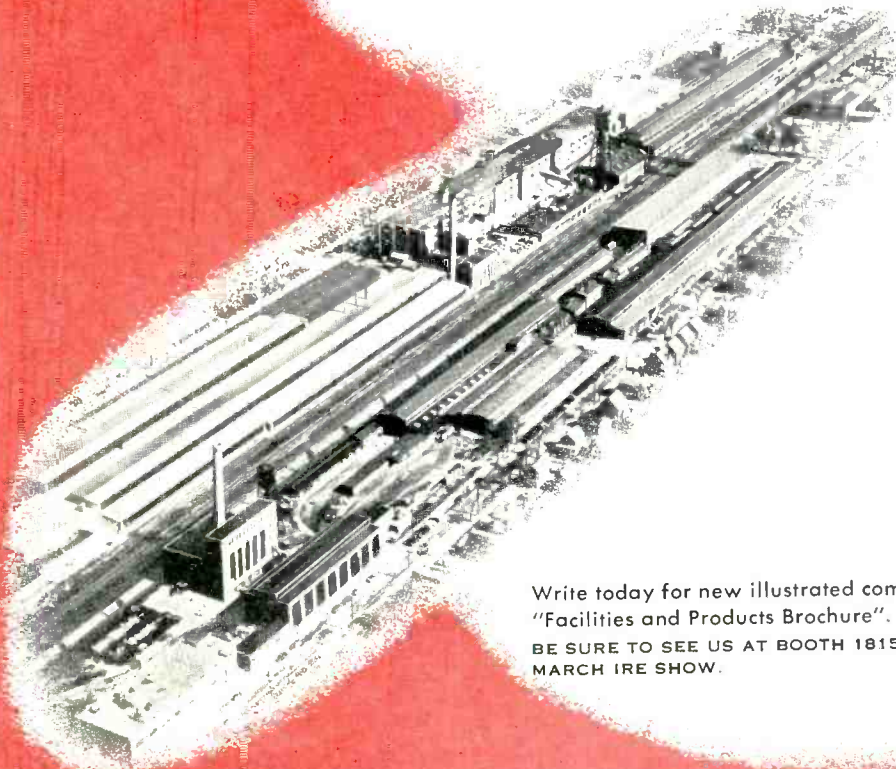

Write today for new illustrated comprehensive "Facilities and Products Brochure".

BE SURE TO SEE US AT BOOTH 1815-17,
MARCH IRE SHOW.



MACK ELECTRONICS DIVISION INC.
A WHOLLY OWNED SUBSIDIARY OF MACK TRUCKS INC.
plainfield new jersey

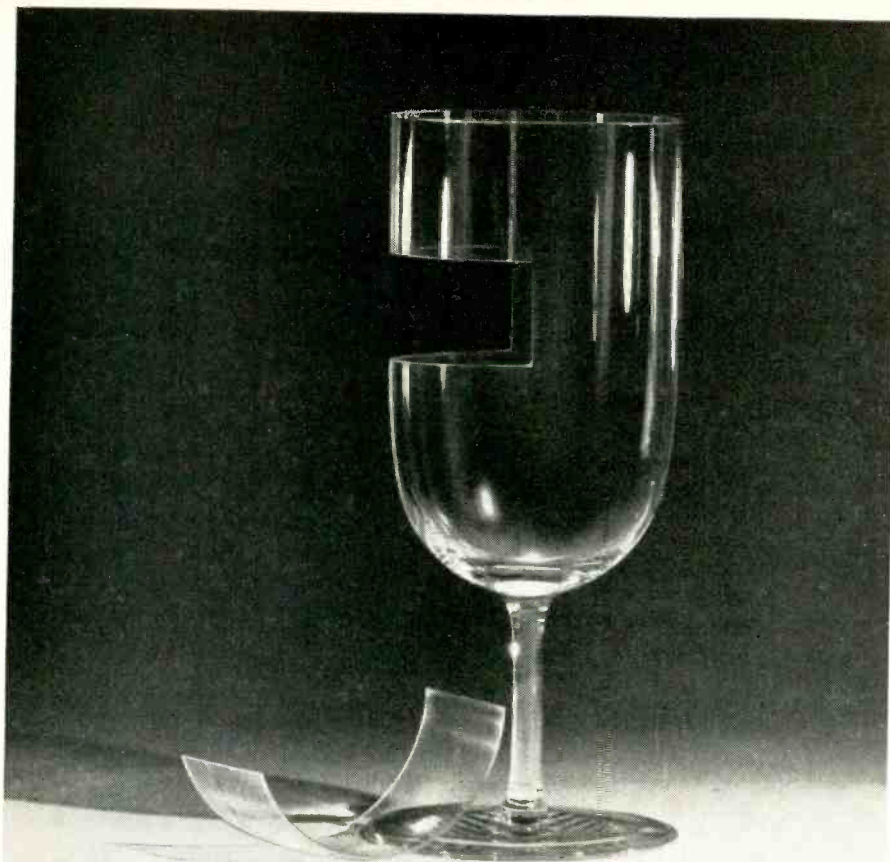

for Super-Fine Cutting
of Hard, Brittle Materials...
the *S. S. White*
Industrial Airbrasive® Unit

Many delicate industrial cutting and abrading operations — once considered impractical or downright impossible — are now easily accomplished with our Industrial Airbrasive Unit. Developed from the Airdent® equipment made by S. S. WHITE for the dental profession, the unit gas-propels a concentrated stream of abrasive particles at high speed for a fast, cool, shockless cutting action.

The unit can be used in wire-stripping . . . calibrating . . . to remove surface deposits . . . etch glass . . . cut germanium and other crystalline forms . . . or to etch, drill and light-debur hard, brittle materials.

Every day, many different industries find new uses for the Airbrasive Unit. Perhaps it can make your own manufacturing process easier, less expensive! To see what the Airbrasive Unit will do on your product, send us sample parts and details. For further information, just write to

S. S. White

First Name in Airbrasive Cutting

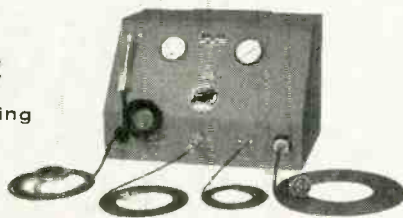

S. S. White Industrial Division, Dept. 15A, 10 East 40th Street, New York 16, N. Y.
Western Office: 1839 West Pico Blvd., Los Angeles 6, Calif.

stability better than one part in 10^8 per day, synchronization between transmitting and receiving sections can be maintained over long periods of time. Automatic phasing, simplified channel switching and interchangeability of sub-assemblies are among the other design features. Circle P26 inside back cover.



LOAD ISOLATOR
Ku-band Ferrite type

LITTON INDUSTRIES, 5873 Rodeo Road, Los Angeles 16, Calif. Model U90 Ferrite load isolator is especially designed for new military radar operating in the Ku-band frequencies. It provides a minimum of 10-db isolation over the bandwidth of 16,300 to 16,700 mc at 90 w average power and 90 kw peak. Insertion loss is 0.7 db maximum and the input vswr is 1.05 maximum.

Designed for use under rugged environmental conditions, operating characteristics are guaranteed over a temperature range of -55°C to $+100^{\circ}\text{C}$ and under vibration per MIL-E-5272A. A cover totally enclosing the magnet prevents disturbance of the magnetic field and change of electrical characteristics during the operating life of the system. Circle P27 inside back cover.

SINGLE-TURN POT
linear in function



BORG EQUIPMENT DIVISION, The George W. Borg Corp., Janesville, Wisc., has announced production of its new 910 series single-turn Micropot potentiometer. It is a high precision instrument, linear in function, and offers such ad-

KOVAR

glass-sealing alloy



EXPERIENCE
of users proves
the superiority of
KOVAR ALLOY

because it  **MATCHES PERFECTLY**
 **FUSES READILY**
 **BONDS PERMANENTLY**

KOVAR[®]

*makes the **BEST** glass-to-metal seals*

For more than 21 years, Kovar has been the first choice of users of glass-sealing alloys. Kovar holds its leadership because of its uniform quality, its availability in all desired forms and the Technical Service provided by the Stupakoff organization.

This unique metallic alloy matches perfectly the thermal expansion characteristics of certain hard glasses; it is

easy to join to other metals by welding, soldering or brazing; it is available in the form of sheets, strip, wire, rod and tubing—as well as fabricated into cups, eyelets, leads, etc.

Twenty-one years of manufacturing and research experience guides Stupakoff engineers in the application and use of Kovar Alloy. Let our technical service help you gain the benefits it offers!

 20 YEARS
Western Electric 20 YEARS
18 YEARS

 26 YEARS
Eimac TUBES
15 YEARS

 13 YEARS
MACHLET
17 YEARS

Bomac 8 YEARS
 20 YEARS

 7 YEARS
RAYTHEON 20 YEARS

 15 YEARS
© Westinghouse Trade Mark No. 337,962

STUPAKOFF DIVISION OF
The CARBORUNDUM Company

WRITE DEPT. E   LATROBE, PENNSYLVANIA

"I guess we're married to
the man from
PHILLIPS"

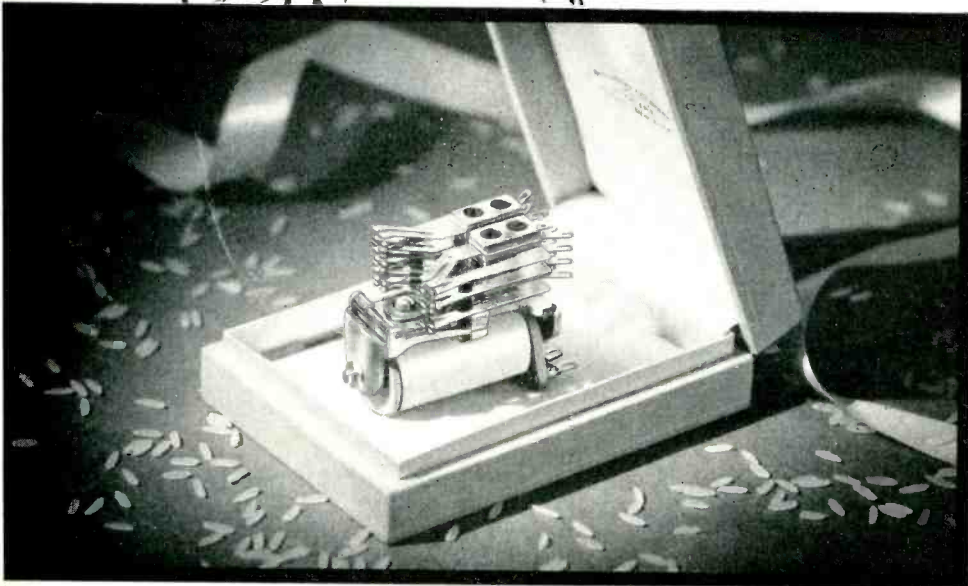

your relays

propose problems? Long life, compactness, high reliability and close adjustment! Are these all requirements for your electronic control, communication or data handling application? Then, the multi-contact telephone Type 8 relay is for you. To assure performance while retaining precision adjustment, Type 8 is fitted with a heavy duty bronze armature bearing. Standard twin contact springs insure maximum reliability with minimum contact resistance. Versatile, too, this relay is available with many variations in coils, contact assemblies, contact rating, adjustments, terminal arrangements and mountings — each combination for a specific application. Single or double-wound coils, for almost any voltage or current operation, may be equipped with slugs or sleeves for time delay on pick-up or drop-out.

Whatever your specifications, whatever your application—get in touch with the reliable "man from PHILLIPS." Write, wire or phone the Phillips office nearest you.

COIL CHARACTERISTICS:
Operating Voltage: up to 300 volts D.C.
Resistance: up to 21,000 ohms.
Single or double wound.
Operating Current: 0.002 Amps., minimum
Operating Time: 0.060 Secs., maximum
0.002 Secs., minimum

CONTACT ASSEMBLY:

All forms A thru E.
Single or double pileup
Code #24 Twin Palladium contacts, standard
Other contacts available.

MOUNTING:

Two No. 6-32 Tapped holes, standard

VARIATIONS:

Plug-in mounting and terminals
Printed circuit terminals
Taper tab terminals
Metal enclosures
Hermetically sealed.

HERMETIC SEALS. MULTI-CONTACT. POWER. HERMETICALLY SEALED RELAYS. ACTUATORS

PHILLIPS

PHILLIPS CONTROL CORPORATION . . . JOLIET, ILLINOIS

AN ALLIED PAPER CORPORATION SUBSIDIARY

SALES OFFICES: NEW YORK - PHILADELPHIA - BOSTON - SAN FRANCISCO - DENVER - SANTA MONICA
WASHINGTON - WINSTON SALEM - CLEVELAND - DALLAS - SEATTLE - KANSAS CITY - ST. LOUIS - DETROIT

NEW PRODUCTS

(continued)

vantages as extreme accuracy, fine resolution, low torque, long life and consistent, reliable performance under adverse environmental conditions.

The resistance element and terminal leads are molded into a single unit for better operation under severe vibration and high temperature conditions. Units may be ganged, and each cup may be individually phased in the field. All models have ball-bearing mounted shafts.

The 910 series Micropot has a power rating of 5 w at 40 C, and a resistance range of 50 to 10,000 ohms. Standard tolerance is \pm five percent. Standard linearity accuracy is \pm 0.5 percent independent. Starting torque is 0.5 in.-oz. per section. It features continuous mechanical rotation, 340 deg or less electrical rotation. Net weight is four oz per single unit, with 1 oz added for each additional unit. Length of a single unit is 1 3/64 in.; width, 1 1/8 in. Shaft is 5/8 in. long, with special lengths available. Circle P 28 inside back cover.

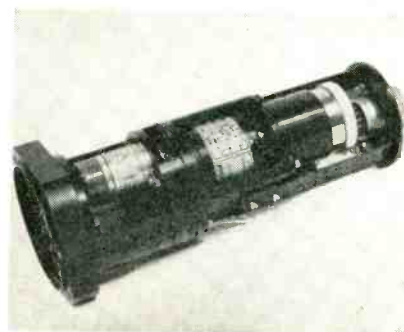

DATA REPEATERS
of the servo type

FEEDBACK CONTROLS, INC., 903 Main St., Waltham 54, Mass., offers a line of servo-type data repeaters with high accuracy and fast response. Designed for use as flight-test instrumentation, the repeaters provide remote indication of angular position and of a-c and d-c voltages. The data repeaters mount in standard aircraft panels with output dials arranged for visual observation or photographic recording.

The first of the two basic types is the synchro-data repeater, a two-speed follow-up servo employ-

March 1, 1957 — ELECTRONICS

SHOCK ABSORBER

WEIGHING ONLY

0.0000028 lb!

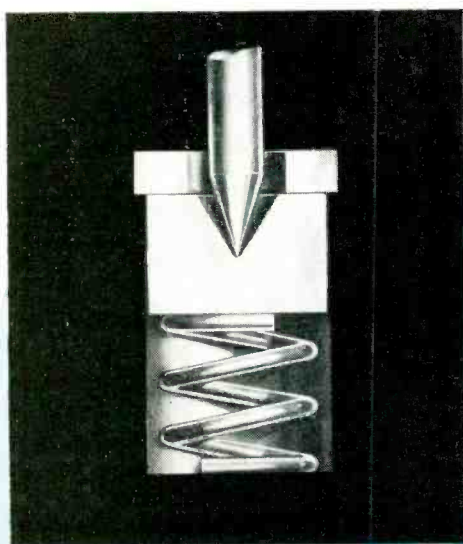

Tiny shock-absorbing springs, shown greatly enlarged at the left, provide a *second line of defense* against shock damage in Weston ruggedized panel meters. While the entire instrument movement is cradled on an effective overall shock mount of specially formulated rubber, these tiny shock absorbers, mounted in back of each jewel bearing, provide double protection at the critical points. The spring-backed jewel in ruggedized instruments is another Weston FIRST . . . one which assures continuous, dependable service wherever panel meters are subject to severe impact, vibration or shock.

EXPANDED FACILITIES NOW MAKE WESTON RUGGEDIZED PANEL METERS READILY AVAILABLE FOR MOST NEEDS . . . MANY TYPES AND SIZES FROM STOCK. Consult your nearest Weston representative, or write Weston Electrical Instrument Corp., Newark 12, N. J.

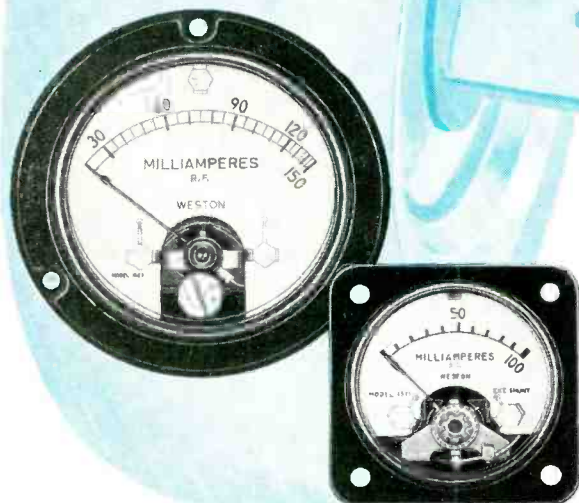

Weston ruggedized instruments are approved in all sizes—1 1/2", 2 1/2", 3 1/2", 4 1/2".

WESTON

Ruggedized

PANEL INSTRUMENTS





*Have you the growth
potential to make
top money as a*

CONVAIR MISSILES MAN?

Get the facts on **CONVAIR POMONA** in sunny California — *first* fully-integrated missile plant in the U. S. A. — designer and builder of the Navy's **TERRIER** supersonic, surface-to-air missile.

Naturally, you'll work with the most modern electronic equipment known. Better yet, you'll work with the kind of engineering talent that *creates* such equipment... that is pacing the advance of science into outer space.

You'll have the scope and help to show what you can do ... and top pay at every step you progress. You and your family will live (California-style) in the lush Pomona Valley at the foot of the snow-capped Sierra Madre. No commuting problems. Ample housing. True country living just 30 minutes from downtown Los Angeles.

Openings now in:

Electronics	Operations Research
Aerodynamics	Hydraulics
Dynamics	Mechanical Design
Thermodynamics	Laboratory Test

Generous travel allowance to Engineers accepted.

Write now, enclosing complete resume to:

Engineering Personnel Dept. 3-G

CV CONVAIR GD
POMONA

POMONA • CALIFORNIA

CONVAIR IS A DIVISION OF GENERAL DYNAMICS CORPORATION

ing standard Bu Ord Mark 54, Mod 2 synchro transmitters. They are available with four different speed ratios between synchros.

The second type is the potentiometer-data repeater, a position servo which utilizes a precision 10-turn Helipot as the follow-up transducer.

Thermostatically controlled viscous-coupled inertia damping is used to achieve high-velocity constants. The units employ v-t preamplifiers and magnetic output stage in the servo amplifiers. **Circle P29 inside back cover.**

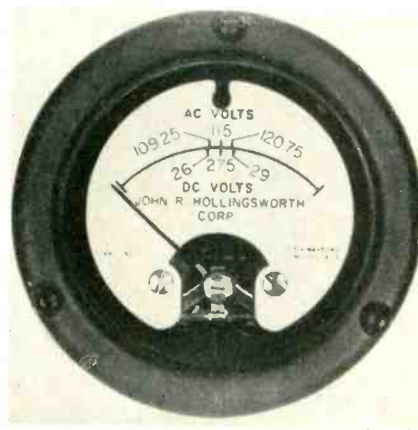

BASIC METER

ruggedized and sealed

WACLINE, INC., 35 So. St. Clair St., Dayton 2, Ohio. Illustrated is a 2½-in. round basic meter made to meet the requirements of military specifications MIL-M-6A and MIL-M-10304A. It features extra high sensitivity, high torque to weight ratio, a minimum number of parts and a new simplified pressure-method of sealing and ruggedizing. The meters are available in all standard ranges of microammeters, milliammeters, ammeters and voltmeters. **Circle P30 inside back cover.**

D-C POWER SUPPLY

for computer applications

PERKIN ENGINEERING CORP., 345 Kansas St., El Segundo, Calif., announces a d-c power supply with steady state regulation accuracy of ± 0.01 percent for computer applications. This unit has a ripple of less than 50 mv peak-to-peak

SHIELDING'S *Universal* ENCLOSURE
PROVIDES MAXIMUM SHIELDING EFFECTIVENESS
... FOR COMPLYING WITH ALL APPLICABLE
MILITARY SPECIFICATIONS.

R. F. *interference* SUPPRESSED

Shielding has the practical solution to all your electro-magnetic suppression problems — the Shielding Universal Enclosure. Multi-Cell® design features either single or double shielding in cell or isolated type enclosure . . . interchangeable standard panels of solid and/or mesh material . . . a wide variety of enclosure sizes both standard and custom-built. A complete test report, performed by independent consulting engineers in accordance with military specifications, has just been completed — evaluating designs and different types of material used. For your copy of this report and the new Shielding folder giving all design details, write today to:

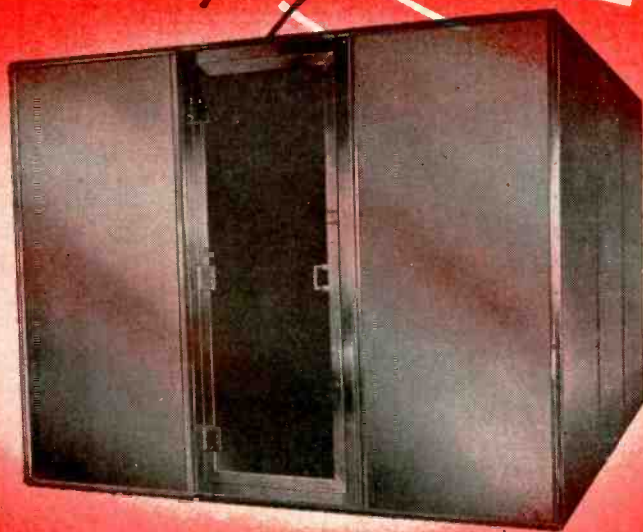

SHIELDING, INC.

12 RESERVE STREET RIVERSIDE, NEW JERSEY

SALES OFFICES:

CHICAGO — R. EDWARD STEHM
DENVER — WILLIAMS & ASSOCIATES
LOS ANGELES — CARL A. STONE ASSOCIATES, INC.
FORT WORTH — MITCHELL SPEARS COMPANY
CANADA — MJS ELECTRONICS SALES LTD., AJAX, ONTARIO

See us at Booth #1114-1115 March I.R.E. Show

NEW!---IMPROVED!

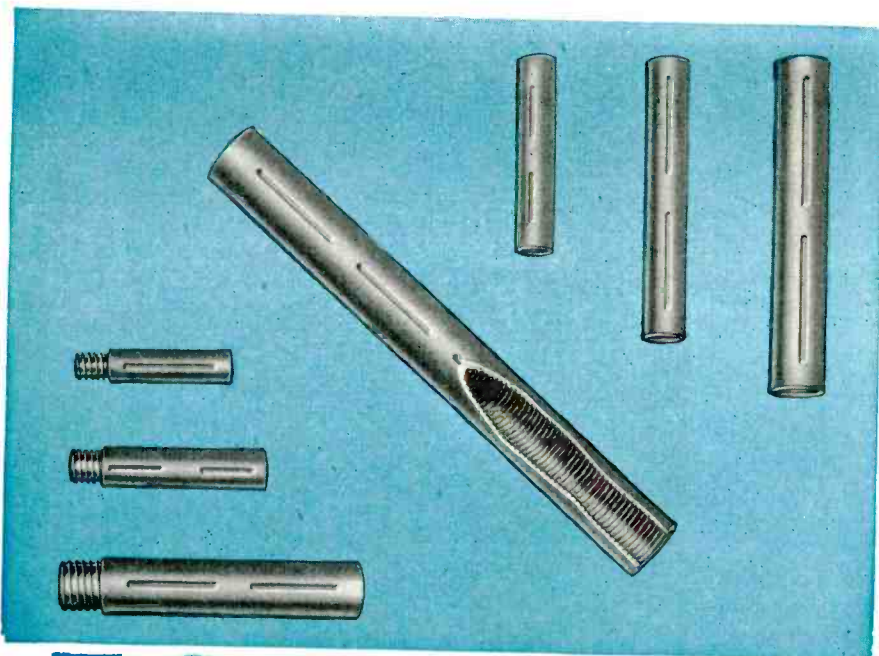

TORKRITE

Your answer for smooth torque without stripping!

NEW TORKRITE tubing is now scientifically brushed and lubricated to give that extra protection which ensures better performance.

IMPROVED TORKRITE is internally threaded and embossed to provide a smooth and constant torque action, engineered to meet every requirement.

ONLY TORKRITE COIL FORMS have these **NEW** built-in qualities.

* * *

Write for our latest brochure showing complete line of **CLEVELITE*** Phenolic tubing.

Visit our Exhibit #2317, Radio Engineering Show
Coliseum, New York City—March 18-21

*Reg. U. S. Pat. Off.

THE CLEVELAND CONTAINER COMPANY

6201 BARBERTON AVE. CLEVELAND 2, OHIO

PLANTS AND SALES OFFICES:

CHICAGO • DETROIT • MEMPHIS • PLYMOUTH, WIS. • OGDENSBURG, N.Y. • JAMESBURG, N.J. • LOS ANGELES

ABRASIVE DIVISION of CLEVELAND, OHIO

Cleveland Container, Canada, Ltd., Prescott and Toronto, Ont.

Representatives:

NEW YORK AREA: R. T. MURRAY, 604 CENTRAL AVE., EAST ORANGE, N. J.
 NEW ENGLAND: R. S. PETTIGREW & CO., 62 LA SALLE RD., WEST HARTFORD, CONN.
 CHICAGO AREA: PLASTIC TUBING SALES, 5215 N. RAVENSWOOD AVE., CHICAGO
 WEST COAST: IRV. M. COCHRANE CO., 408 S. ALVARADO ST., LOS ANGELES

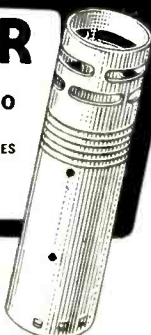

NEW PRODUCTS

(continued)



and a d-c output of 200 v ± 10 percent at three amperes. The dynamic regulation is: \pm one percent for a ± 15 -percent step change in a-c input; \pm one percent for a 50-percent load change. The unit is designed for a three-phase, 60 cps a-c input of 208/230 v, ± 15 percent.

The power supply also has an extremely low dynamic impedance and incorporates an ultrafast magnetic amplifier with instantaneous electronic control. No saturating type a-c regulators (with their consequent noise) or large energy-storage capacitor banks are employed. Overall dimensions of the unit are 19½ in. wide by 15 in. deep by 12½ in. high. Circle P31 inside back cover.

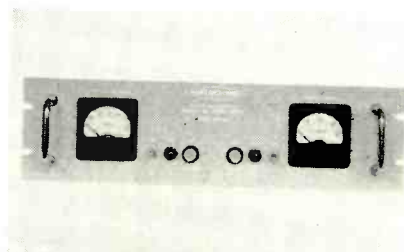

LAB POWER SUPPLIES

mount in standard relay rack

REFLECTONE CORP., Stamford, Conn., has developed two new laboratory power supplies giving different output ranges: model PS-L225 for 125 to 325 v 0 to 200 ma d-c, 6.3 v 10 amperes a-c; and model PS-L425 for the 325 to 525 v d-c range.

The units are designed for continuous heavy-duty operation. They incorporate protection against external overloads or internal failure. Units are electronically controlled and substantially free from noise and hum.

Input of each is 105 to 125 v,

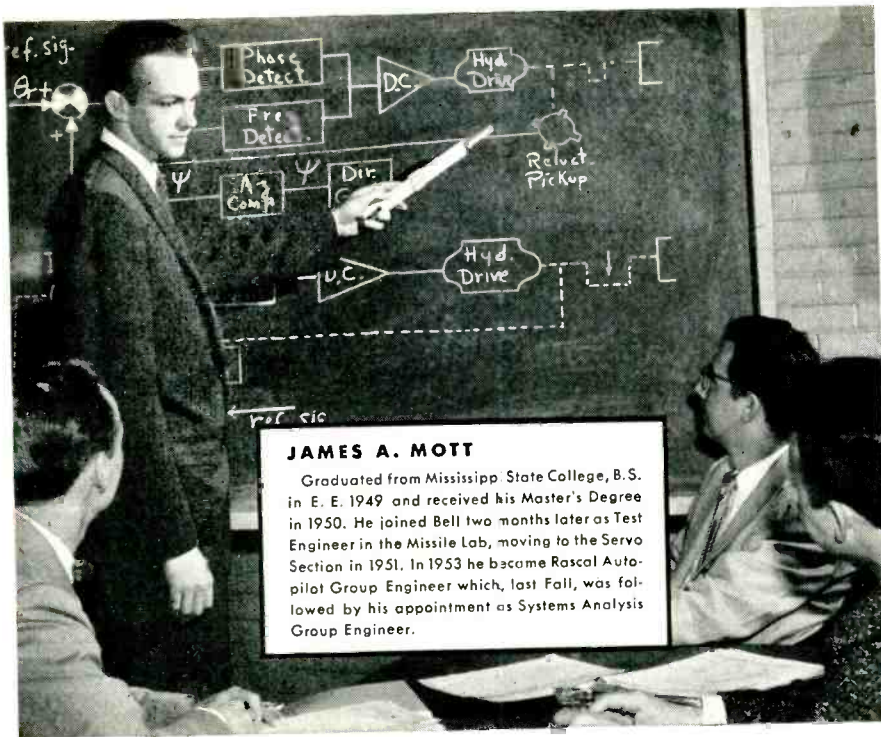

JAMES A. MOTT
 Graduated from Mississippi State College, B.S. in E. E. 1949 and received his Master's Degree in 1950. He joined Bell two months later as Test Engineer in the Missile Lab, moving to the Servo Section in 1951. In 1953 he became Rascal Autopilot Group Engineer which, last Fall, was followed by his appointment as Systems Analysis Group Engineer.

There are **NEW** Opportunities at BELL

James Mott is typical of the successful engineers who are now teamed together in Bell Aircraft's, newly-created Avionics Division with greatly expanded facilities and a building of its own. This recent divisional reorganization has created many top-flight openings for engineers and technicians and vastly broadened their opportunities for professional accomplishment. That fact, together with the number and wide diversity of Bell's projects, are insurance that your future at Bell will be limited only by your own capabilities.

You'll work in a fast moving, successful organization—in ideal surroundings with associates who have fine professional records. You'll have every opportunity to grow, learn and progress. Pay is high, benefits exceptional, and living conditions the best. If you're not moving fast enough or going far enough in your present position, contact Bell.

Write today: Manager, Technical Employment, Dept. H32, Weapon Systems Division, **BELL AIRCRAFT CORPORATION, P. O. Box One, Buffalo 5, New York.**



- Aerodynamicists
- Aeronautical Engineers
- Automatic Control Designers
- Chemical Engineers
- Combustion Research Engineers
- Communications Engineers
- Design Checkers
- Development Engineers
- Digital Computer Development Engrs.
- Dynamic Engineers
- Electronic Engineers
- Electronic Standards Engineers
- Engineering Computers
- Environmental Specialists
- Field Test Engineers
- Flight Test Engineers
- Flight Test Programmers
- Fuel Injection Specialists
- Gear Designers
- Guidance Engineers
- Gyro Specialists
- Heat Transfer Engineers
- Hydraulic Engineers
- IBM Programmers
- Instrumentation Specialists
- Laboratory Test Engineers
- Magnetic Amplifier Specialists
- Mathematical Analysts
- Mechanical Engineers
- Microwave Engineers
- Miniturization Engineers
- Operations Analysts
- Physicists
- Power Plant Designers
- Pressure Vessel Designers
- Project Engineers
- Publication Engineers
- Radar Systems Engineers
- Rocket Test Engineers
- Servo Systems Engineers
- Servo Valve Engineers
- Statisticians
- Stress Engineers
- Structures Engineers
- Specification Writers
- Technical Writers
- Test Equipment Engineers
- Transformer Design Specialists
- Transistor Application Engineers
- Thermodynamic Engineers
- Telemetry Engineers
- Turbine Pump Designers
- Vibration & Flutter Analysts
- Weapons Systems Engineers
- Wave Guide Development Engineers
- Weights Engineers

Foolproof! Shockproof!
"FLOATING BODY ISOLATION"
for double-lead screw locking
CONNECTORS



New, "Floating Body Isolation"* guarantees vibra-shock protection and operation by complete separation of electrical contact body from mechanical elements. For connector reliability and fool-proof application.

- Unparalleled vibra-shock protection
- High environmental resistance
- Superior performance dependability
- Positive locking action

- Disengagement ease
- Melamine and alkyd molding compounds
- Aluminum cast brackets
- Connectors meet or surpass MIL-Q 5923B and MIL-C 8384 specs

Patent No. 2,761,108
 additional patents pending

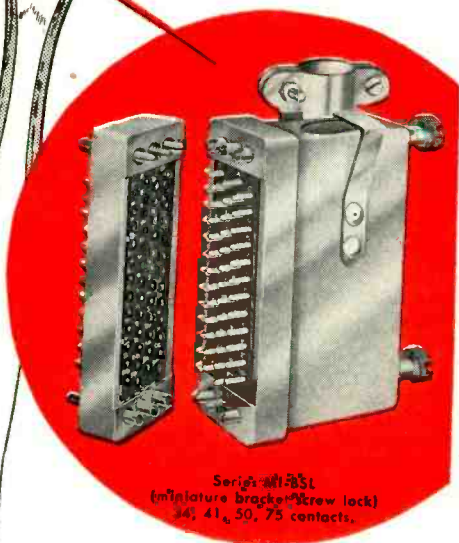

Series: MIBST
 (miniature bracket screw lock)
 34, 41, 50, 75 contacts.

Write TODAY for complete technical data:
U.S. COMPONENTS, Inc.

associated with
 U.S. Tool & Mfg. Co., Inc.
 454 East 148th Street, New York 55, N.Y.
 CYPRESS 2-6525

See us at the I.R.E. Show—Booth 2706, 2nd Floor Components



NEW PRODUCTS

(continued)

50 to 400 cps. The d-c regulation is 0.15 percent or 0.3 v (whichever is greater) against line; 0.25 percent or 0.5 v (whichever is greater) against load. Internal impedance is less than six ohms; ripple is less than three mv rms. Circle P32 inside back cover.



PIRANI VACUUM GAGE
 a one-to-four station unit

CONSOLIDATED ELECTRODYNAMICS CORP., Rochester Division, 1775 Mt. Read Blvd., Rochester, N. Y. A new one-to-four station Pirani vacuum gage with a range from one to 2,000 microns of Hg is now available. Type 2203-03 gives direct, continuous readings of the total pressure of condensable vapors and permanent gases on two scales—one to 50 microns Hg and 50 to 2,000 microns Hg.

The instrument features a new sensing tube which greatly reduces zero drift. The tube operates at a low maximum temperature of 250 C. Deposits of carbon on the filament do not change its emissivity. Both the sensing and the compensating tubes are enclosed in a single metal envelope, thus minimizing the effect of changes in ambient temperature. The combined tube is also smaller, more rugged and easier to install.

Automatic voltage regulation provides for easier operation and permits use of a 0 to 10-mv recorder without constant operator attention.

The 2203-03 incorporates a printed circuit for greater compactness, increased operational uniformity and lower cost. It is 6½ in. high, 11 in. wide, 6 in. deep and weighs 10 lb. It is operable from a 115-v power source but is readily adaptable to 230-v opera-

another example of how **RYAN BUILDS B**

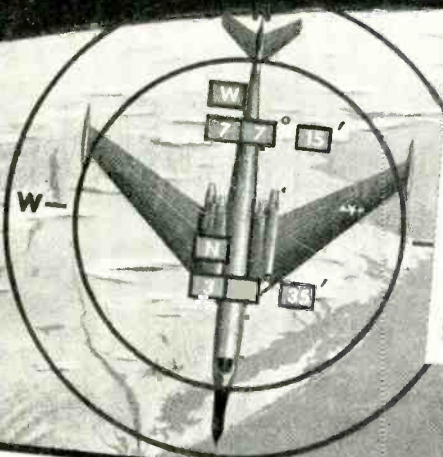

NOW! AUTOMATIC NAVIGATION FOR GLOBAL JET FLIGHT

An advanced system of aerial navigation with the speed and precision demanded by high speed jet flight, has been developed by Ryan Aeronautics. Using continuous-wave radar, in which Ryan is a recognized leader, the Ryan AN AIN 67 navigator will enable fast flying military planes and future commercial jetliners to travel to any point on the earth's surface with new accuracy and speed.

Instantaneous in operation, the Ryan navigator gives the pilot his position - latitude and longitude.

Electronic engineers will find a challenging future with outstanding opportunities at Ryan

With a background of 33 years experience in aviation, Ryan excels in designing and producing high quality aircraft, power plants and avionics, built at low cost, delivered on time.

RYAN
AERONAUTICAL COMPANY
LONG BRANCH, NEW JERSEY

Break Through The PROBLEM Barrier

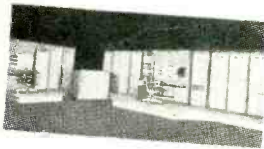

Making it possible for Engineers to break through the problem barrier is our most important project. Since our Company's inception, constant attention to the human engineering factor has brought about such advantages as High Speed Servos, Automatic Extended Readout with push-button control, Problem Checkers, Electronic Multipliers, Servo Voltmeters, Resolvers and Function Generators, etc. Our standard production has the further advantage of actual time in the field before being announced as "new". Just one more reason why you can always look to PACE for Progress in Analog Computing Systems, for reliability, stability and overall economy. For details, write Electronic Associates, Inc., Dept. IA-7, Long Branch, New Jersey.

ELECTRONIC ASSOCIATES
Incorporated

EAI SETS THE PACE
PRECISION ANALOG COMPUTING EQUIPMENT
LONG BRANCH, NEW JERSEY

The decision is precision...

...as it was with Ryan Aeronautical Company.

That is why Ryan selected Electronic Associates' PACE Analog Computing Equipment to help them break through the problem barrier. 1) EAI's PACE equipment provides highest accuracy in precision analog computing equipment. 2) EAI sets the PACE for reliability and versatility. 3) EAI's unique and economical building block method provides for your future as well as your present problem barriers. Contact our Computation Centers for a demonstration or for time rental. There's a Center serving Eastern Industry in Princeton, N. J., one serving Western Industry in Los Angeles, Calif. Or, for equipment information, write Electronic Associates, Inc., Long Branch, N. J. Dept. EL 3

Visit Our Booths

Which Are Nos. 1202 - 1204 - 1206 - 1208
At The I.R.E. Show - March 18-21.

ELECTRONIC ASSOCIATES
Incorporated

EAI SETS THE

LONG BRANCH • NEW JERSEY

P A C E
PRECISION ANALOG COMPUTING EQUIPMENT

Vital to Semiconductors!

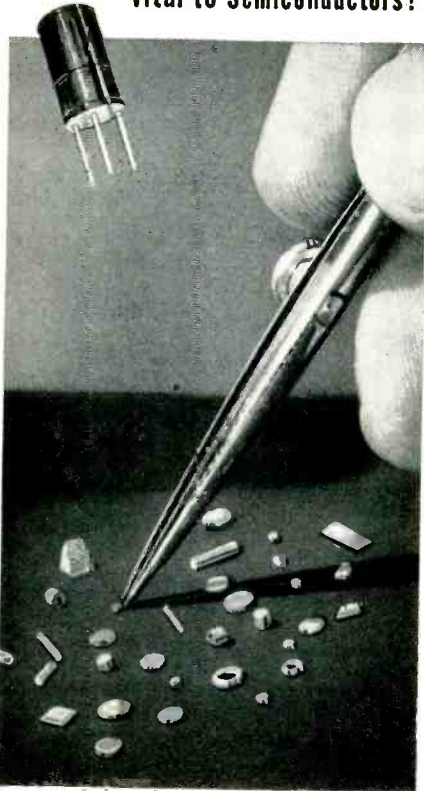

Alpha UHP* ultra high purity metals—

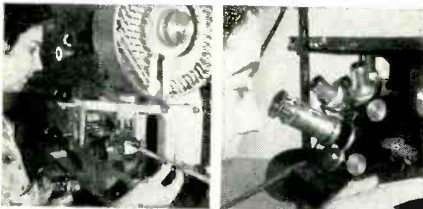

Modern precision equipment is used for rolling, extruding and punching.

Precision devices for accurate inspection are part of our standard equipment.

what are they—and what do they mean to SEMICONDUCTORS?

The performance of semiconductors are vitally effected by *small bits of rare metals* such as INDIUM, GALLIUM, ANTIMONY, ARSENIC and others, which must possess the highest degree of purity... be critically close in tolerance... and offer complete alloy uniformity.

Alpha, a pioneer in high purity metals, offers all of the metals and their alloys, commonly used in semiconductor manufacture, in a complete range of uniform sizes and shapes. All pellets, discs, washers and spheres are processed from metals approaching 99.999 in purity.

Whether you are interested in Alpha's semiconductor UHP products for experiment or production, they are available to you in minimum quantities and any shape or alloy that suits your needs.

For further information, write Dept. CS today.



SEE Automatic Soldering IN ACTION at booth 4319 . . . I.R.E. SHOW

NEW PRODUCTS

(continued)

tion. Data sheet No. 9-31 gives further information. Circle P33 inside back cover.

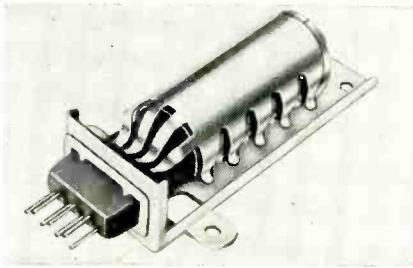

TUBE SHIELD for flat press subminiatures

INTERNATIONAL ELECTRIC RESEARCH CORP., 145 W. Magnolia Blvd., Burbank, Calif. This new subminiature tube shield mount is of a right-angle design having an integral socket for three, four, five, six and seven-pin flat-press tubes. The design gives engineers a compact, easy-to-install heat-dissipating clamping mount that is ideal for use in confined spaces while permitting ready access for service or tube replacement.

Shields are silver plated overall with inner wrap of pure silver for maximum heat conductivity. The spring clip and right-angle base are of beryllium copper. Circle P34 inside back cover.

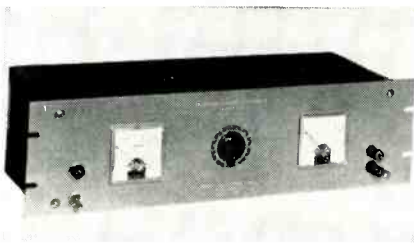

H-C POWER SUPPLIES utilize transistors

ELECTRONIC RESEARCH ASSOCIATES, INC., 67 East Centre St., Nutley 10, N. J., announces a series of new designs intended to eliminate the drawbacks inherent in vacuum tube, thyatron or magnetic amplifier equivalents.

Features include fast transient response, small size and weight, close regulation, low ripple content and independence from line response changes.

Electrical design includes line isolation and full-wave rectifica-

...the authors

Most of the books written by Laboratories authors are published by D. Van Nostrand Company. Other publishers include John Wiley & Sons and McGraw-Hill. Subjects include speech and hearing, mathematics, transmission and switching circuits, networks and wave filters, quality control, transducers, servomechanisms, quartz crystals, capacitors, visible speech, earth conduction, radar, electron beams, microwaves, waveguides, antennas, traveling-wave tubes, semiconductors, ferromagnetism.



Harold S. Black, B.S. in E.E., Worcester Polytechnic Inst., author of "Modulation Theory."



John R. Pierce, Ph.D., California Inst. of Tech., author of "Traveling-Wave Tubes."



Richard M. Bozorth, Ph.D., California Inst. of Tech., author of "Ferromagnetism."



W. Thornton Read, M.S., Brown University, author of "Dislocations in Crystals."



Hendrik W. Bode, Ph.D., Columbia University, author of "Network Analysis and Feedback Amplifier Design."



Walter A. Shewhart, Ph.D., University of California, author of "Economic Control of Quality of Manufactured Product."

The books...

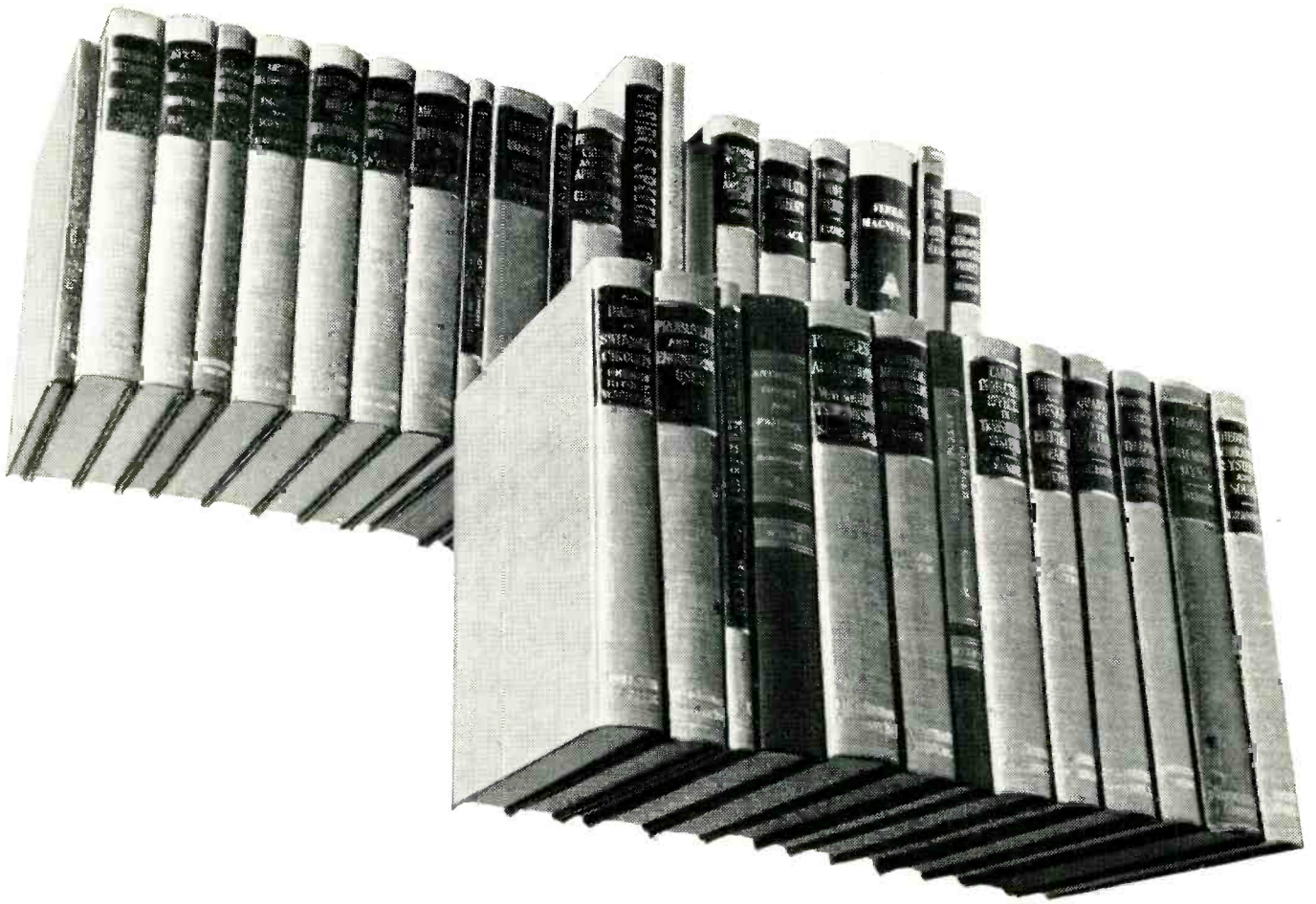

How the scientific world shares in fruits of the telephone art

In their work to improve telephony the scientists and engineers of Bell Telephone Laboratories make important findings in many sciences. They thoroughly report these findings in professional journals and magazines. But sometimes, as knowledge accumulates in a vital field, a "treatment in depth" is prepared in book form.

Bell Laboratories authors have written 36 books to date and others are in preparation. Many have become classics in the Laboratories' primary field of communications. Many have become standard works of wide application because they provide a fundamental guide for technologies in other fields. For example, the design of automatic switching systems is of primary importance in computers; statistical quality control provides the indispensable basis for economical manufacture. Through their books these scientists and engineers and the Laboratories attempt to repay

benefits they receive from the published works of others.

The pictures on the opposite page show some Bell Laboratories authors of technical books. A complete listing of titles may be obtained by sending in this coupon.

Publication Department, Dept. 18

BELL TELEPHONE LABORATORIES
463 West Street, New York 14, N. Y.

Gentlemen:

Please send me a listing of titles, authors and publishers of books written by Bell Telephone Laboratories authors.

Name.....

Street.....

City..... State.....



BELL TELEPHONE LABORATORIES

World center of communications research and development

Want more information? Use post card on last page.

If you require
miniature
and sub-miniature
assemblies
produced with skill
and precision...

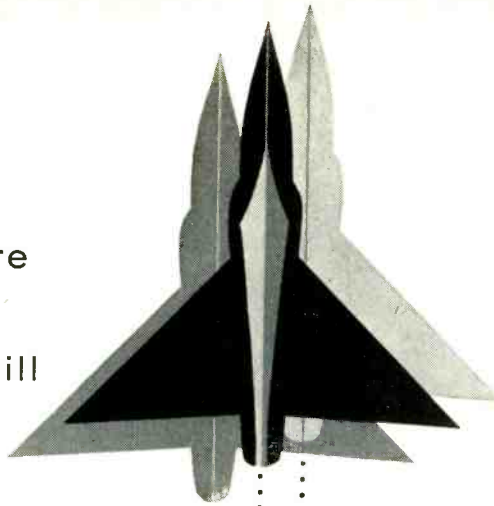

LOOK TO WALTHAM

At Waltham are unrivalled facilities — in men and machines — to mass produce the most precise assemblies to your specifications. The skilled hands which turn out railroad watches and aircraft clocks are equally adept in producing close-tolerance mechanical or electro-mechanical components for other industries. For example, screws so tiny that 17,000 will fit in a thimble . . . tolerances of .0002" . . . are all in a day's work.

Let us show you how Waltham's facilities can supplement your own...when quality and prompt deliveries are essential!

WALTHAM TYPE W-12 ELAPSED TIMER

Specification
MIL-C-7047 A

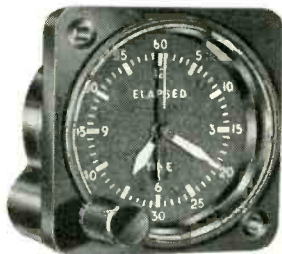

NOW AVAILABLE FOR CIVILIAN APPLICATION

This high quality timer, with proven performance in military aircraft under actual combat conditions, exemplifies the quantity production skills that have made Waltham famous.

12 hour dial with sweep second hand. 22 jewel movement, operates 6 days without rewind. Dustproof, moistureproof case. Vibration-resistant. 1 7/8" dial. Easily installed. Write for specification sheet.

INSTRUMENT AND INDUSTRIAL PRODUCTS DIVISION

WALTHAM WATCH COMPANY
WALTHAM 54, MASSACHUSETTS

*Precision
has been
our business
since
1850*

tion utilizing silicon rectifiers. Regulation is accomplished at d-c with germanium junction transistors in special circuitry. References used are silicon zener diodes.

Several stock models are available with adjustable output voltage ranges of 6 to 32 v d-c and current ranges of four, eight, and 12 amperes. All models are designed for 105 to 125 v a-c input, 60 to 400 cps. Line regulation is within 0.5 percent; load regulation, within 0.5 percent (for 20-100 percent load change). Ripple is less than one mv. Prices start at \$395. Circle P35 inside back cover.

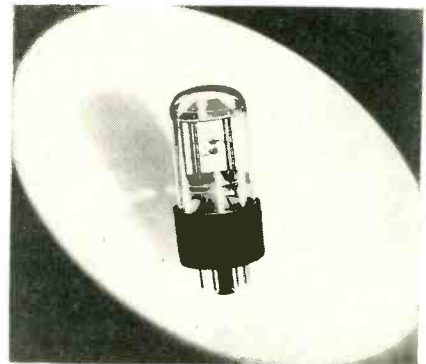

QUARTZ CRYSTAL sealed-in-glass unit

BLILEY ELECTRIC Co., Union Station Bldg., Erie, Pa. The BG9D-S is a 100-kc sealed-in-glass quartz crystal unit for use in secondary frequency standards. The DT-cut element is designed especially for use in temperature-controlled ovens. Tolerance is ± 5 ppm at 70 C. Temperature coefficient is less than 0.7 ppm per deg C between +65 C and +75 C. The BG9D-S is 3 1/8 in. overall in a T-9 bulb with standard octal base. Design specifications, including reference to specific crystal ovens, are found in bulletin No. 492. Circle P36 inside back cover.

SUBMINIATURE POT features minimum torque

ACE ELECTRONICS ASSOCIATES, INC., 103 Dover St., Somerville 44, Mass., announces a new jewel bearing, subminiature precision wirewound potentiometer for applications requiring minimum



Where the connection is blind



Blind-man's buff is no child's play when you're trying to make or break an electrical connection by Braille. If your installation men are groping in the dark through a spaghetti tangle of wires and gear - if they're trying to make connections around blind corners . . . they'll grow old and bitter before their time.



Deutsch push-pull miniature connectors



Keep your crew young and happy . . . with Deutsch Push-Pull Connectors. They simply push in (on the end of a tube, if necessary) to connect, automatically lock and seal. Pull back (with a lanyard, if it's remote) for instant disconnect. Push-pull . . . all in a straight line.

Connector-conscious engineers will be interested in our complete line of miniature Push-Pull standard and AN connectors. Their portraits and exciting life stories are presented in Bulletin 301. Shall we send you a copy? Tell us where.



The Deutschman will be looking for you at the I.R.E. Show. March 18-21. New York Coliseum. Booth 3921.

7000 Avalon Boulevard
The Deutsch Co.
Los Angeles 3, California

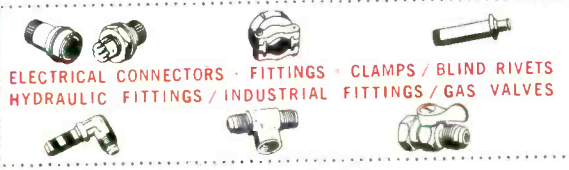
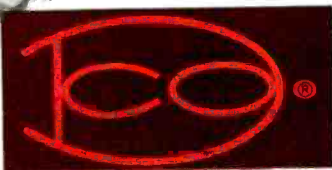

NOW Tensolite TEFLON[®] MAGNET WIRE



- ✓ FOR PRODUCTION WINDING
- ✓ NEW KIT FOR R & D

© Du Pont



FOR PRODUCTION WINDING

TEFSOLITE Teflon Magnet Wire is available in unlimited production quantities, in all gauge sizes from 20 through 44 AWG with the four standard coating thicknesses (single, heavy, triple, and quad). This teflon-coated Magnet Wire features highest quality and flexibility, excellent continuity, and good abrasion resistance. Most gauge sizes and thicknesses are available on an OFF-THE-SHELF delivery basis.

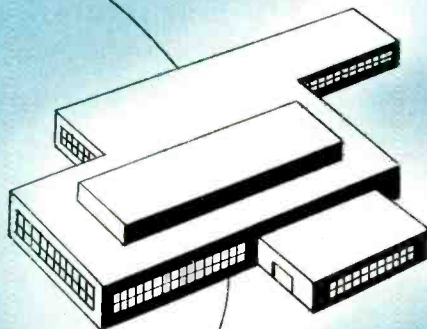

NEW KIT FOR R & D

In response to many requests Tensolite has created a Tensolon Magnet Wire LABORATORY KIT for use in Research and Development applications. This kit contains an assortment of twelve, specially designed, easy-to-handle miniature spools of Tensolon Magnet Wire ideally suited for use by design engineers and technicians. It is available for immediate delivery. Write for complete specifications and pricing information.

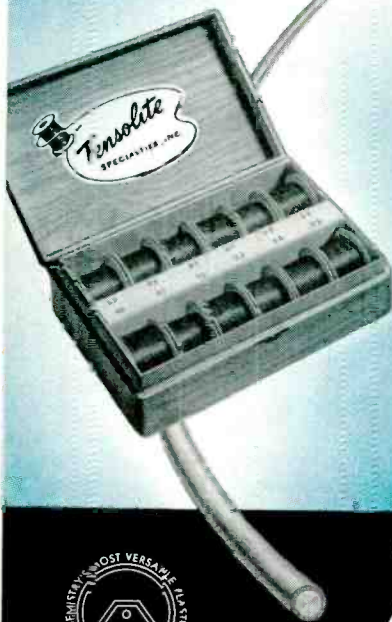

Tensolite

SPECIALTIES, INC.

198 MAIN ST. TARRYTOWN, N. Y.

starting and running torque. This Aceptot has precision jewel bearings that provide extremely low torque and also seal against abrasive dust or other foreign matter. These units are ideal for sensitive instrument application and for servo, computer or selsyn use.

Because of the low torque required to rotate the shaft, no appreciable error is introduced and highest accuracy is maintained.

► **Specifications**—Torque is 0.01 oz in.; size, 1/2 in. by 1/2 in.; resistance range, 10 to 250,000 ohms standard (higher or lower on special order); linearity, ±0.3 percent; power rating, two w for 60 C rise; weight, 1/4 oz including lock washer and nut; temperature, -55 C to +150 C. It meets applicable portions of JAN specifications and MIL-E-5272A standards. Circle P37 inside back cover.

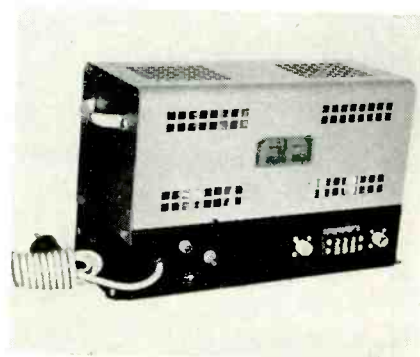

TRANSIENT CONVERTER for turbine type flowmeters

FISCHER & PORTER Co., 950 Jacksonville Road, Hatboro, Pa., has developed a transient converter for use with turbine type flowmeters. The converter accepts a sinusoidal input signal of varying frequency and provides either an analog output for recorders and oscillographs or a digital output to counters and computers.

Input frequency range for the new unit is from 0 to 600 cps, operating from a 500-ohm source impedance. The output is a 0 to 100-mv analog signal or a 10-v positive pulse (at eight times the input frequency) to digital devices.

The unit has a short-term analog accuracy and linearity of ±0.5

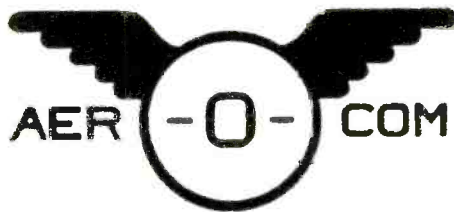

DEFINITELY DEPENDABLE!

Aerocom's Dual Automatic Radio Beacon

Reliability is built into every part of this dual 1000-watt aerophare unit. Ruggedly constructed and conservatively rated, it provides trouble-free unattended service, and at truly low operating and maintenance cost. It operates in the frequency range 200-415 kcs, using plug-in crystal for desired frequency.

Uses single phase power supply, nominal 220 volts, 50 or 60 cycles. Consists of two 1 kw transmitters with keyer (2 keyers if desired), automatic transfer unit and weatherproof antenna tuner. Each transmitter housed in separate standard rack cabinet, with controls in rack cabinet between the transmitters.

Nominal carrier power is 1000 watts. High level plate modulation of final amplifier is used, giving 30%-35% tone modulation. P-T switch interrupts tone, permitting voice operation. Operates in ambient temperatures from -35°C to 50°C, humidity up to 95%.

Standby transmitter is placed in operation when main transmitter suffers loss (or low level) of carrier power or modulation, or continuous (30 sec.) tone. Audible indication in monitoring receiver tells when standby transmitter is in operation.

Antenna may be either vertical tower or symmetrical T type.

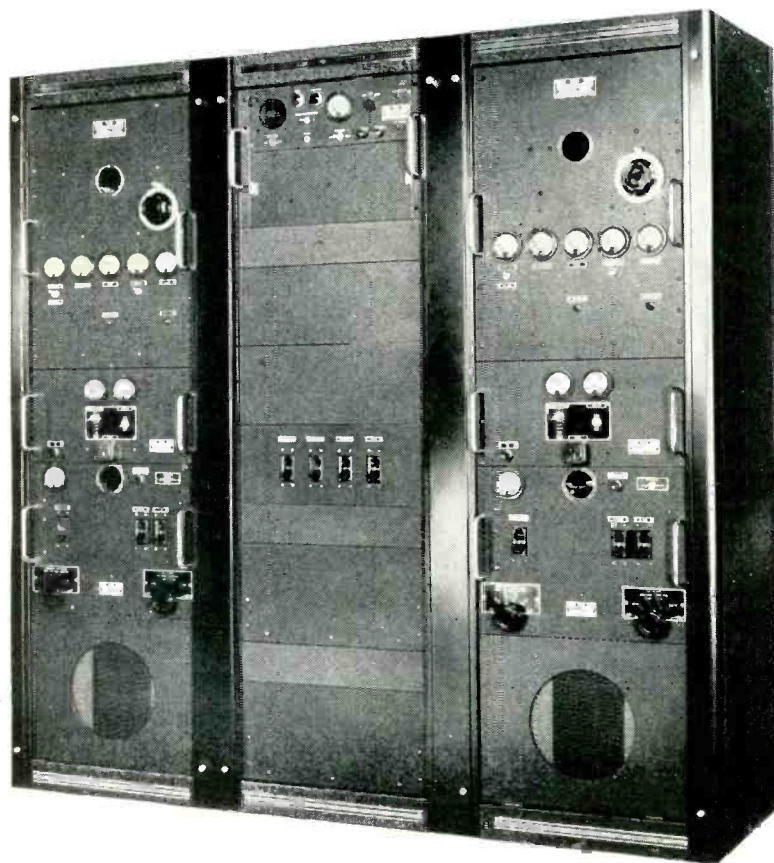

Also available in
50 WATT
100 WATT
and
4 KILOWATT
models

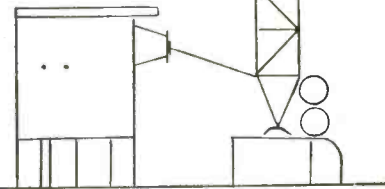

A-101



3090 S. W. 37th AVENUE • MIAMI, FLORIDA

NEY'S SMALL PARTS PLAY A BIG PART IN PRECISION INSTRUMENTS • NEY'S SMALL PARTS



PRECIOUS METAL

ENGINEERED CONTACTS, SLIP RINGS & ALLOYS

Ney designs and makes to customers' specifications sliding contacts, slip rings and assemblies, commutator segments and assemblies, brush and brush holder assemblies, and precious metal resistance wire. Consult Ney's Engineering Dept. and find out how precious metals can improve your products.

THE J. M. NEY COMPANY, P.O. BOX 990, DEPT. E HARTFORD 1, CONN.
Specialists in Precious Metal Metallurgy since 1812



Ney has just built this modern new plant to give you even better products and better service.

percent and a long-term accuracy of ± 3 percent. Rise time is 10 milliseconds for a 40 to 600-cps step. Accuracy of the digital output is absolute. The converter features plug-in subassemblies for easy maintenance. Circle P38 inside back cover.

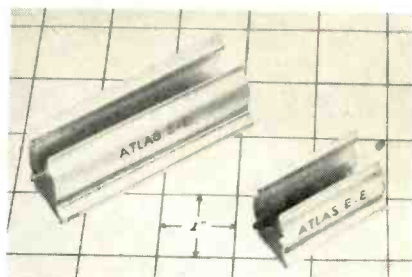

COMPONENT HOLDERS many new variations

ATLAS E-E CORP., 47 Prospect St., Woburn, Mass., has available over 300 new variations in its line of component holders. The clip-type holders have a built-in feature in their design which automatically provides greater holding power as the metal of the holder flexes under heavy vibration and extreme temperature changes. They have been tested to 90 g at 2,000 cycles without resonant frequencies.

The new variations include light-weight slotted holders for glass, paper and plastic envelopes and cases such as subminiature tubes and capacitors; silver-plated beryllium copper holders for applications requiring non-magnetic material and heat-treatable silver alloy holders for applications requiring maximum heat dissipation. Tests show their function as heat dissipators permits up-rating of 2 w to 10 w wirewound resistors by as much as 50 percent. Holders are available in diameters from $\frac{1}{8}$ in. to $1\frac{1}{2}$ in. with lengths from $\frac{1}{8}$ in. to 4 in. Circle P39 inside back cover.

POTENTIOMETERS for high-temperature use

G. M. GIANNINI & Co., INC., 918 E. Green St., Pasadena 1, Calif., announces development of a high-temperature, infinite-resolution po-

TRANSFORMERS FOR ELECTRONICALLY REGULATED POWER SUPPLIES

Now... over the counter

Avoid delay in making your breadboards, no waiting for a special when a

STERLING 2K SERIES

transformer will meet your requirements exactly. Stock STERLING 2K units are available for supplies from 100 milliamperes at 100 volts to 400 milliamperes at 300 volts



Technical specifications on a typical unit of this family of transformers for use in a 300 volt 200 milliampere dc regulated power supply with 90 to 130 V AC input:

ST2010

Primary: 115 Volts AC, 50 to 1000 cps

Secondaries:

570-0-570V	240 madc*
5.0V	3 A
6.3V	3 A
6.3V	1.2A
6.3VCT	6 A

*Note 40 ma provided

Size: 5 $\frac{1}{8}$ x 4 $\frac{1}{8}$ x 5 $\frac{1}{2}$ H
Mtg. Centers: 3 $\frac{1}{2}$ x 3 $\frac{1}{2}$
Weight 15 lbs.
Associated Choke: ST2009
4 Henries at 240 madc.

Each 2K transformer provides:

- PLATE VOLTAGE ALLOWANCE FOR PASS TUBE.....
- RECTIFIER FILAMENT POWER.....
- PASS TUBE FILAMENT POWER.....
- REGULATOR CIRCUIT FILAMENT POWER.....
- AUXILIARY FILAMENT POWER FOR OTHER CIRCUIT REQUIREMENTS.....
- REGULATOR CIRCUIT PLATE POWER.....
- APPLICATION BULLETIN WITH EACH UNIT

Military versions of each of these units is also available. Technical data on the complete line is available on request.

SAMPLES? SPECIALS? SHORT RUNS?

The 2K series is only one of the many types we make. We specialize in custom-built transformers to your specifications. Let our engineering staff help solve all your transformer problems.

Samples delivered in 1 to 3 weeks.



299 North 7th St., Brooklyn 11, N. Y.
STagg 2-4200

NOW! the first all ceramic

klystron

tube for

1600 to

6500 mc

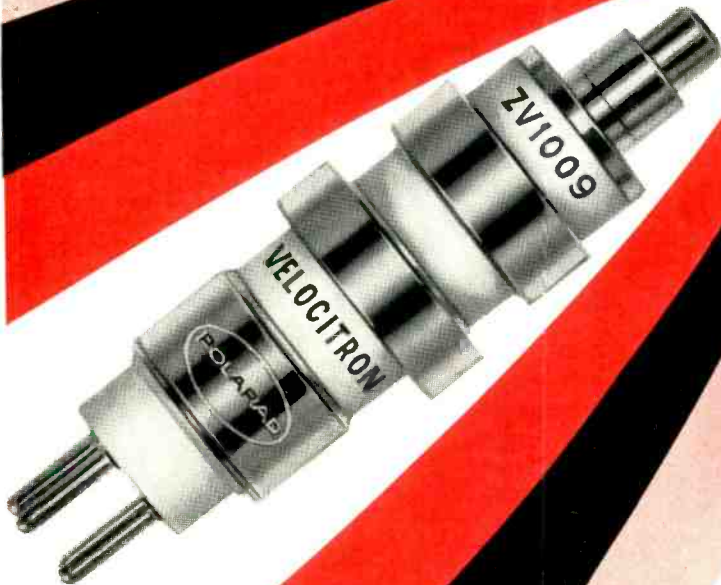

RUGGEDIZED POLARAD ZV1009 VELOCITRON* †

a physical and
electrical replacement
for klystron tubes 6BL6, 5836

The new Polarad ZV1009 all ceramic Velocitron is a premium, rugged tube designed for high temperatures, vibration and mechanical shock.

As a replacement for glass klystrons: the ZV1009 is less microphonic and less fragile. It is equipped with standard 4-pin connection.

As a basic design element: The all ceramic ZV1009 allows for higher ambient temperatures than any glass tube currents available. It is completely hard soldered.

SPECIFICATIONS: ZV1009 VELOCITRON

Reflector Mode	1 3/4	2 3/4	3 3/4
Cavity Mode	3/4	3/4	5/4
Frequency	2800	3200	5000 mc
Power Output Cutoff Voltage (approx.)....	+3	+3	+3 volts
Reflector Voltage (approx.)	-220	-120	-220 volts
Resonator Voltage	325	325	325 volts
Control Electrode Voltage (Full Power Output)	+10	+10	+10 volts
Cathode Current (average)	28	28	28 ma
Electronic Tuning Range (between Half Power Points—minimum).....	6	6	6 mc

Write directly to Polarad for complete data and design information.

*Registered U.S. Trademark

†Manufactured under Western Electric Patents

POLARAD

PROVEN RELIABILITY

ELECTRONICS CORPORATION

43-20 34th Street · Long Island City 1, N. Y.

REPRESENTATIVES: Albany, Albuquerque, Atlanta, Baltimore, Boston, Chicago, Cleveland, Dayton, Denver, Englewood, Fort Worth, Kansas City, Los Angeles, New York, Philadelphia, Portland, Rochester, St. Louis, San Francisco, Schenectady, Stamford, Syracuse, Washington, D. C., Winston-Salem, Canada: Arnprior, Ontario.

Resident Representatives in Principal Foreign Cities



**TYPE
BG12G-S**

HOLD 0.1 ppm PER DAY

WITH *New* 100kc CRYSTAL

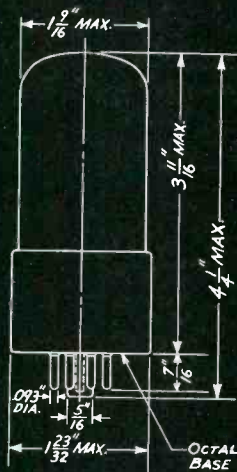

This new sealed-in-glass 100 kc GT-cut crystal has been designed for use in your primary frequency standard.

A maximum temperature coefficient of 0.2 ppm per degree centigrade will provide stability better than 0.1 ppm per day when used in the Bliley type TC97A oven.

Improved process treatment assures that ageing will not exceed .01 ppm per day after six months operation. Initial ageing is less than .03 ppm per day under recommended conditions.

WRITE FOR BULLETIN 498.

**Bliley
CRYSTALS**

BLILEY ELECTRIC COMPANY

UNION STATION BUILDING • ERIE, PENNSYLVANIA

SEE YOU AT THE RADIO ENGINEERING SHOW • BOOTH 2736 • NEW YORK COLISEUM

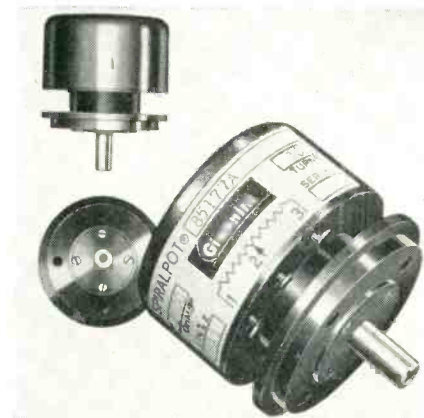

tentiometer that has been added to its Spiralpot line of slide-wire type precision pots. Use of special materials and alloys in the winding drum and vital elements allows a power rating of 1.5 w at 150 C.

Model 85177A is available with linearities of 0.1 and 0.05 percent in standard resistance values of 50, 100, 150, 200 and 250 ohms per turn in ten-turn units. Other shaft rotations from 1 to 10 turns and other resistance values as low as two ohms per turn are also available.

These pots excel in many applications such as found in high-resolution servo systems, computers or indicating systems, where the presence of elevated temperature does not allow the use of other standard Spiralpots. Circle P40 inside back cover.

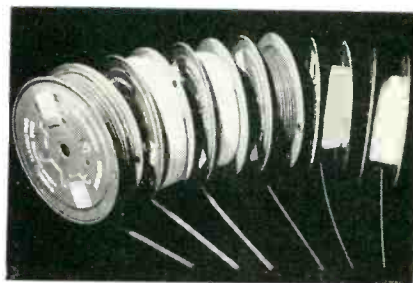

TEFLON TUBING

available in new sizes

THE POLYMER CORP. OF PENNSYLVANIA, 2140 Fairmount Ave., Reading, Pa. Polypenco Teflon spaghetti tubing is now available in Awg wire sizes of zero, one, two, three, four, five, six, seven, 28 and 30. The high-temperature tubing is used as a low and high-frequency insulation sleeving for electronic component development. The thin wall tubing has a minimum dielec-

DUSTON BROWNE, NEW YORK

Remington Rand

UNIVAC SYSTEM

REMINGTON RAND UNIVAC® DIVISION — IS ANOTHER OF THE HUNDREDS OF IMPORTANT COMPANIES WHO DEPEND UPON PYRAMID FOR MANY OF THEIR CAPACITOR AND RECTIFIER COMPONENTS

DR. JOHN W. MAUCHLY
CO-INVENTOR OF THE UNIVAC® SYSTEM
DIRECTOR, UNIVAC®
APPLICATIONS RESEARCH CENTER

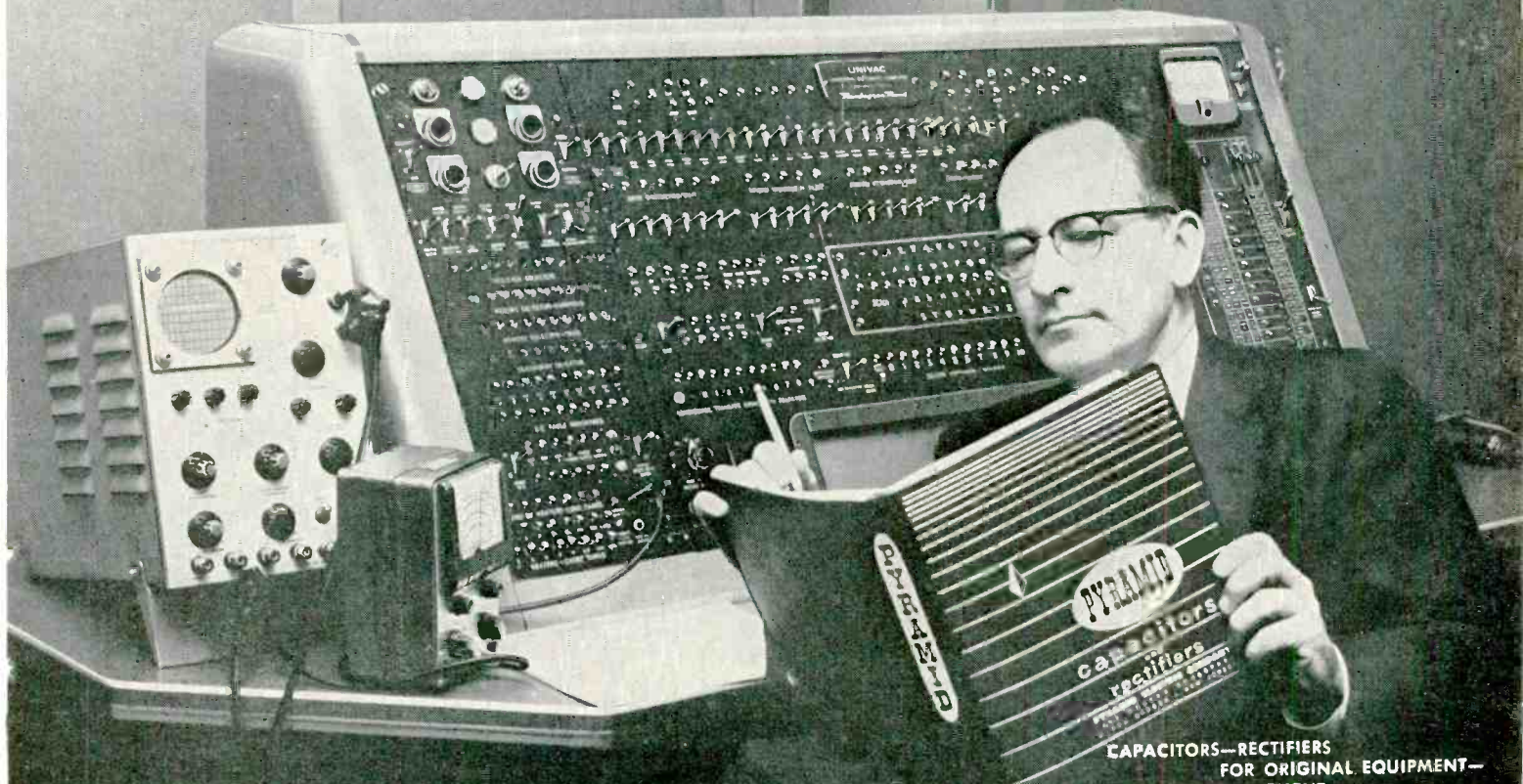

CAPACITORS—RECTIFIERS
FOR ORIGINAL EQUIPMENT—
FOR REPLACEMENT



PYRAMID ELECTRIC COMPANY
NORTH BERGEN, NEW JERSEY

PRECISION

The Only COMPLETE COIL FORM SERVICE

Available...

- SQUARE TUBES
- ROUND TUBES
- RESINITE COIL FORMS
- BOBBINS
- MANDRIL SERVICE
- FABRICATING SERVICE

SQUARE AND RECTANGULAR TUBES

Produced in any length, shape or size from $\frac{1}{16}$ " to 8", wall thickness from .010 to .125. Fabricated from dielectric kraft, fish paper, quintera or combinations, including mylar. Bowed sidewall or Di-Formed construction.

ROUND TUBES

Produced in any decimal size up to 8" I.D. Fabricated from kraft, fish paper, cellulose acetate, mylar, polystyrene, quintera, fibre glass and other dielectric materials.

RESINITE COIL FORMS

These coil forms have the highest resistivity of any resinated product. Furnished plain, embossed, internally threaded or triangular shape... also flyback transformer forms.

BOBBINS

Supplied round, square or rectangular. Cores fabricated from any of the above materials. Metal, asbestos, plastic or fibre flanges. Constructed to fit smaller spaces and permit multiple winding.

MANDRIL SERVICE

Accurately ground steel and aluminum coil mandrils at cost economy comparable to commonly used undependable wood or undersized steel mandrils.

FABRICATING SERVICE

We have modern high speed equipment to provide you with any special shape or form... rolled, spun, flared, punched or formed to your particular requirement.

Ask about Precision's complete coil form service.
Request informative bulletin.

NEW PRODUCTS

(continued)

tric strength of 750 v per mil, a low dielectric constant of 2 and a high surface resistivity above 10^{12} ohms per cm^2 .

The material permits assembly miniaturization because it combines outstanding electrical properties with a wide temperature service range of -320 F to $+555$ F, zero water absorption and resistance to flex and vibration. It completely resists soldering heats and is unaffected by bending and flexing during assembly. Circle P41 inside back cover.



RELAY ELIMINATOR

has no moving parts

ALCOR ELECTRONICS CORP., 180 Lafayette St., New York 13, N. Y. Model 530 TREPAC (Teleprinter Relay Eliminator Package) consists of a transistorized switching circuit with silicon diodes and a built-in rectifier powered directly from 115 v a-c, 50/60 cps line. As a static unit with no moving parts, it is practically maintenance free. Useful life will exceed the life of relays currently on the market.

Physically, the TREPAC is a small plug-in can equipped with a standard octal plug and designed to be normally installed in the printer housing. It eliminates line relay, rectifier, current limiting resistors, spark suppressing filter and printer table wiring. Circle P42 inside back cover.

POWER SUPPLY

priced at \$100

TEKTRONIX, INC., P. O. Box 831, Portland, Oregon. Type 126 power supply furnishes the required volt-



PRECISION PAPER TUBE COMPANY

2041 West Charleston Street, Chicago 47, Illinois

Plant No. 2: 1 Flower Street, Hartford, Conn.

Representatives throughout United States and Canada

F-I-a-s-h!...from Transistor Center, U.S.A.

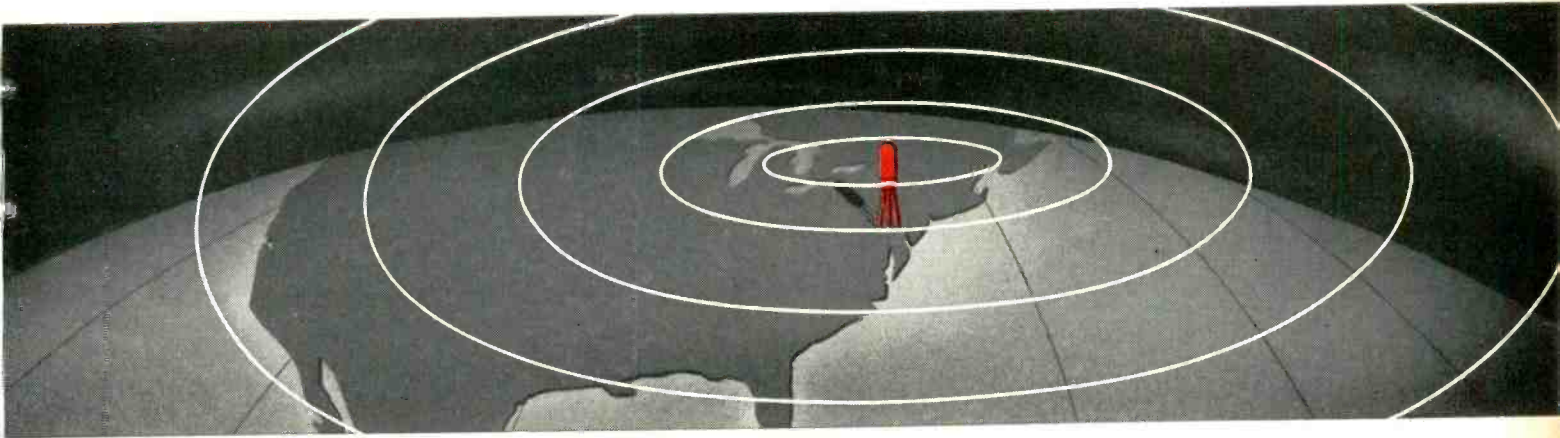

Announcing a new transistor class . . . The PHILCO Micro-Alloy Transistor (MAT)*

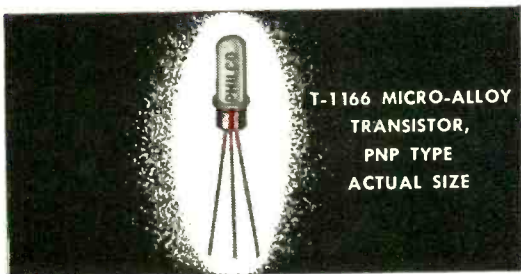

T-1166 MICRO-ALLOY
TRANSISTOR,
PNP TYPE
ACTUAL SIZE

CHECK THESE UNEQUALLED FEATURES

- Excellent High Speed Switching characteristics.
- Low Saturation Voltage (low impedance)
- Excellent high frequency amplification.
- Excellent low-level amplifier over entire frequency range from D.C. to Megacycles.
- Exceptionally Long Life (hermetically sealed)
- Permits high speed computer design with Fewer Stages.

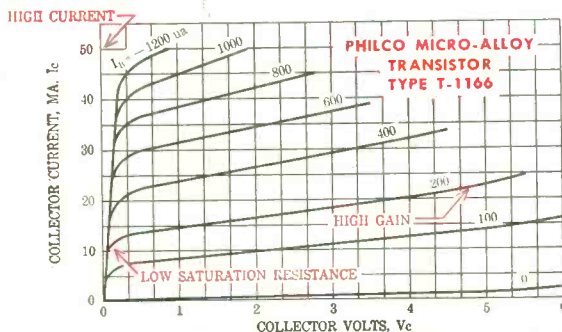

...world's first production transistor with exceptionally high frequency and high gain . . . plus low saturation resistance!

This newest development from Philco Transistor Center features the characteristic high frequency response obtainable with extremely precise base width control. Designed for low voltage operation, the new MAT transistor is especially well suited for high speed applications where low saturation resistance (reduced power consumption) is necessary.

To combine high gain at high currents with high frequency response, the new MAT transistor employs a gallium doped alloy junction for the emitter electrode.

A special short-alloying cycle, combined with precise electro-chemical production techniques (pioneered and developed at Philco Transistor Center for production of SBT), results in the micro-alloy contact for exceptionally high injection efficiency. This new process assures higher gain, and permits operation at higher current. Beta linearity is excellent over the entire range of operating currents . . . up to 50 milliamperes.

● Write for complete information and specifications. Make Philco your prime source of information for high frequency transistor applications.

Visit The Unique Philco Transistor Display at IRE Show, New York Coliseum, March 18-21, Booth # 1410, 1412, 1414.

*Patent Applied For

PHILCO CORPORATION
LANSDALE TUBE COMPANY DIVISION
LANSDALE, PENNSYLVANIA

Write for...

NEW PRODUCTS

(continued)

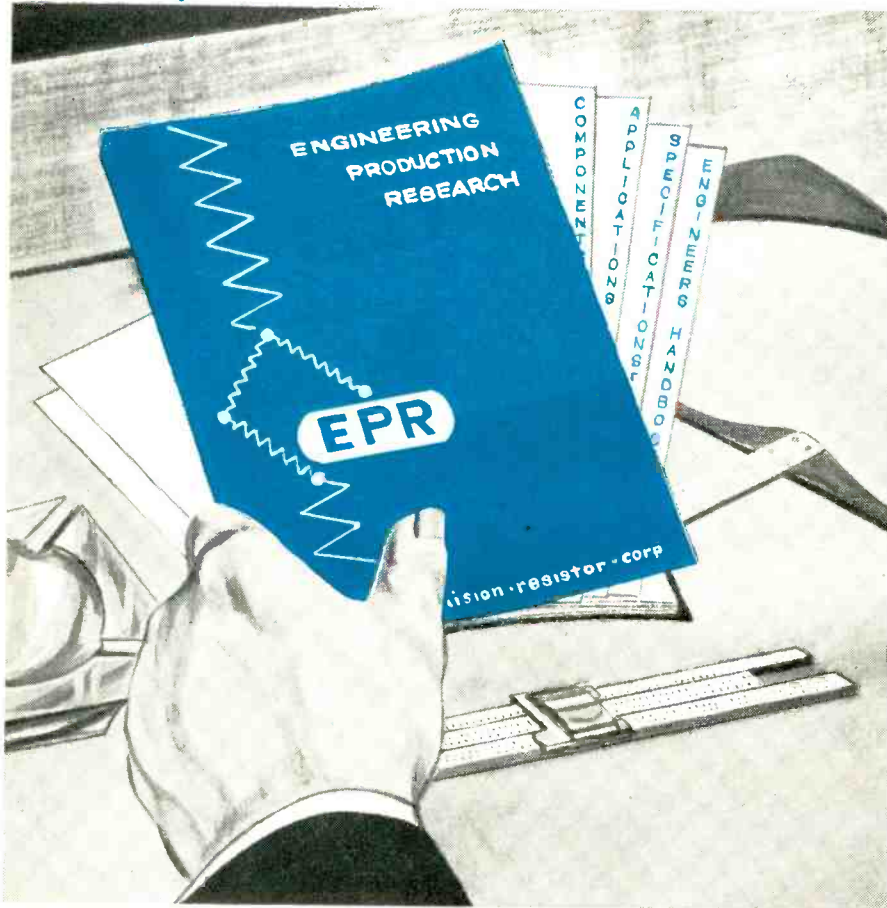

The Industry's First Handbook Of

PRECISION WIRE WOUND RESISTORS

44 PAGES OF TECHNICAL DATA —
NEVER BEFORE OFFERED, ANYWHERE

ALL THE INFORMATION YOU NEED TO
DESIGN, SPECIFY AND PROCURE PRECISION
WIRE WOUND RESISTORS.

DOZENS OF CHARTS, DIAGRAMS,
PROBLEMS AND THEIR SOLUTIONS, ETC.



Be sure you get a copy of this valuable handbook.

STOP IN AND SEE US AT THE IRE SHOW, BOOTH No. 2130

EASTERN PRECISION RESISTOR CORP.

675 BARBEY STREET, BROOKLYN 7, N. Y.



ages and currents necessary to power one type 360 indicator or any one of the type 160-series waveform generators. It mounts beneath the unit to be powered and includes a cabinet to house both the type 126 and the powered unit. Combined with a type 360 indicator it makes a practical, compact slave unit for any Tektronix oscilloscope.

Output voltages are +300 v d-c, unregulated; +225 v d-c, regulated, 45 ma; +150 v d-c regulated, 5 ma; -170 v d-c, regulated, 30 ma; 6.3 v a-c, unregulated, 4 amperes. Weight is 10½ lb. Circle P43 inside back cover.



PHOTOMETER

features flexible operation

EL DORADO ELECTRONICS Co., 1401 Middle Harbor Rd., Oakland 20, Calif. High sensitivity and accuracy, low drift, flexibility of operation and modest cost are salient features of the PH-200 universal photomultiplier photometer. Model PH-200 incorporates a highly regulated electronic power supply. It uses no batteries and is com-



The Equation that Shook the World!

A hasty scrawl on a scrap of paper ushered in the Atomic Age. Through this equation, Dr. Albert Einstein revealed to mankind the awesome secret of atomic fission, with all of its tremendous power for good or evil.

This is the kind of a world we live in . . . a world where knowledge is power in a truer sense than ever before. It is an exciting world.

Univac® has added a new dimension to the world of science, processing data with a speed that crowds many lifetimes of research into a few hours.

Squarely in the midst of this exciting world are the engineers and scientists of Remington Rand Univac. Their potential for growth and achievement (and the rewards that go with them) is unlimited. *You can be one of them.*

Immediate Openings for:

DESIGNERS — With or without formal degrees if qualified. Here are the foremost opportunities to achieve full stature in small mechanisms work. Includes diversifications of both mechanical and electro-mechanical equipment.

ELECTRO-MECHANICAL ENGINEERS — Should have bachelor's degree in Engineering. However, extensive mechanical design background may substitute for some college. Men selected will do basic preliminary design and layout of small mechanisms. Requires original ideas and application of logical analysis to design problems.

Send complete resumé to:

Remington Rand Univac

DIVISION OF SPERRY RAND CORPORATION

ROBERT MARTIN

Dept. NM-2

Wilson Avenue • South Norwalk, Conn.

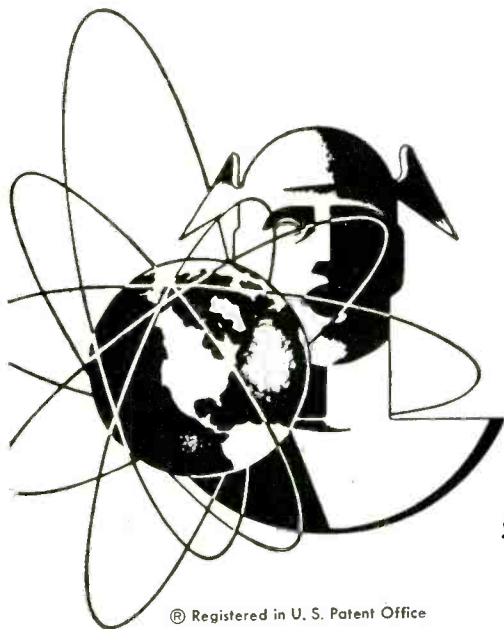

© Registered in U. S. Patent Office

for complex **WAVEGUIDE** assemblies like this



Technicraft advanced design engineering and manufacturing facilities are available to serve your needs from the face of the Magnetron through to the antenna.

MAKE

TECHNICRAFT

YOUR PRIMARY SOURCE

Designed with Precision

Built with Precision

Tested with Precision

FIRST INDUSTRY SHOWING
at the I.R.E. Show in
TECHNICRAFT BOOTH #3810

**NEW (2 to 5 KMC/S) Double Ridged
Flexible and Rigid Waveguide
Assemblies and Components**

This complements the **TECHNICRAFT 4.75 to 11.0 KMC/S Double Ridged Waveguide** now available.

MOLDED FLEXIBLE WAVEGUIDE ASSEMBLIES
in one continuous length up to 100 feet.

**SERVING RADAR AND COMMUNICATIONS WITH THE
BEST IN MICROWAVE TRANSMISSION DEVICES**

TECHNICRAFT LABORATORIES

INCORPORATED

1550 THOMASTON RD. • THOMASTON, CONNECTICUT

Designers and Manufacturers of Rigid and Flexible Waveguide Assemblies, Microwave Test Plumbing and Components, Waveguide Systems.

NEW PRODUCTS

(continued)

pletely self-contained and portable.

Flexibility of use is further enhanced by the provision of separate zero and dark-current adjustments as well as both decade and continuously variable sensitivity controls. These features, together with provision for oscilloscope and graphic recorder readout permit the PH-200 to be applied to a wide range of light measurement problems.

The instrument is 10 in. high, 7½ in. wide, 9 in. deep and weighs but 12 lb. **Circle P44** inside back cover.

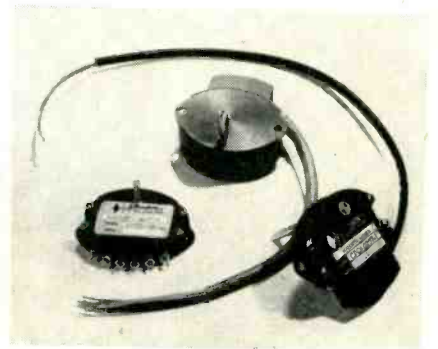

SECTOR POTS

accurate to 0.5 percent

HUMPHREY, INC., 2805 Canon St., San Diego 6, Calif., has introduced a new line of sector potentiometers engineered for control systems and instrumentation in aircraft and missile systems. They are models CPO1-0103-1; CPO1-0207-1, and CPO1-0204-1. They are designed to measure angles from 0 to a maximum of 90 deg of shaft rotation. Accuracy is achieved to 0.5 percent and resolution to 0.10 deg.

The instruments are of rugged, all-metal construction with high temperature insulation, capable of withstanding up to 300 F. All three models are available with shaft extension from either or both sides; also with terminals or with integral cable; singly or in dual gang units. **Circle P45** inside back cover.

COLOR TV MONITOR an improved design

CONRAC, INC., Glendora, Calif. The model CH21B, a new 21-in. color

New Grant 3400

thinslide

*mounts standard 17" chassis
in standard 18" rack or cabinets*

REQUIRES ONLY 19/64" SPACE PER SIDE-

YET HAS

FULL ROLLER ACTION

(fits RETMA rack hole spacing)

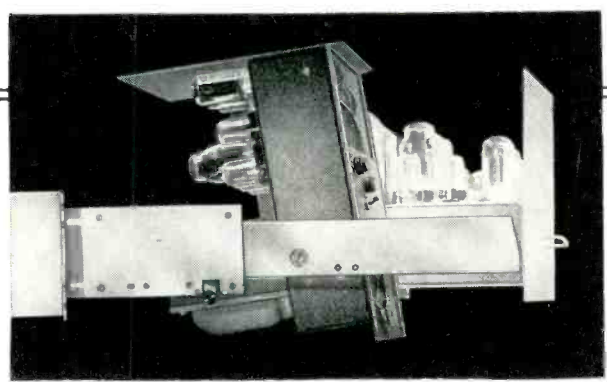

The Grant 3400 Thinslide requires only 19/64" space per side—installs readily in standard racks and cabinets. Allows instant access to chassis measuring from 10" to 16" deep. Tilts through 100° for under-chassis servicing. Positive lock in "out" position. Lock has finger-tip release for instant return or removal of chassis. Eight hardened steel rollers carry the rated load of 100 lbs. smoothly and easily—durability insures frictionless rolling for thousands of cycles of use.

Slide mounting not only provides for quick access—it usually eliminates need for rear access doors and rear aisles—a very important saving of space.

The Grant 3400 is a versatile slide, suited for use in your *product*, in *plant equipment*, *prototype* and *breadboard* work, and in *production line* or *field test equipment*. Very moderate cost allows a wide range of applications in original equipment.

Write today for Grant 3400
Thinslide Technical Bulletin—contains
full data and specifications.

Grant INDUSTRIAL SLIDES

Grant Pulley and Hardware Corporation
factories: 31-73 Whitestone Parkway, Flushing 54, N. Y.
944 Long Beach Avenue, Los Angeles 21, Calif.

See the Grant Industrial Slide Exhibit at the I.R.E. Show, Booth 1118.

potter

Metallized Mylar*

CAPACITORS

**SMALL
SIZE
100 VDC
CAPACITORS
FOR
TEMPERATURES
OF 125°C and
150°C**

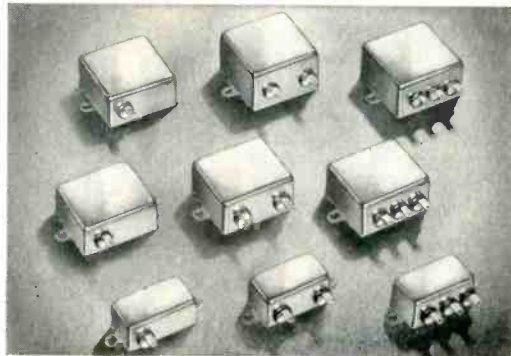
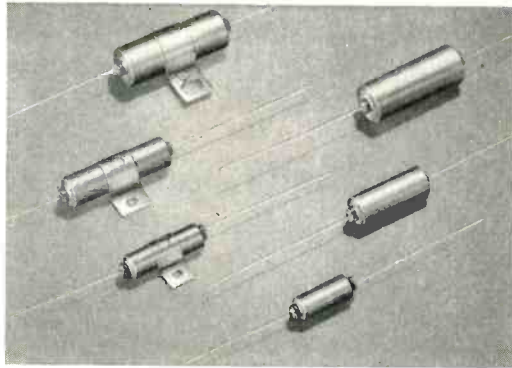

- IMPREGNATION:** Epoxy Resin (150°C only)
- TEMPERATURE RANGE:** -70°C to +150°C.
- SEAL:** Hermetic.
- CONTAINER:** Hot tinned steel can for extra protection against humidity.
- TOLERANCE:** ±10%. (Other tolerances available upon request.)
- TERMINALS:** Silicone bushings with standard solder lug terminals. Side terminals standard; also available with top or bottom terminals.
- WINDINGS:** Non-inductive to insure efficient operation over a wide frequency range.
- TESTING:** Tested at twice the rated voltage.

*"Mylar" is a registered DuPont trademark for its brand of polyester film

THE potter COMPANY
Specialists in Layer Wound Capacitors Since 1925
1950 SHERIDAN ROAD, NORTH CHICAGO, ILL.

NEW PRODUCTS

(continued)

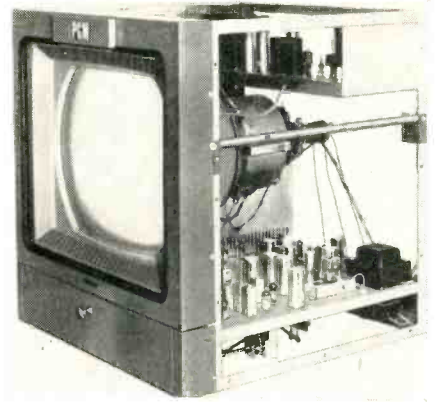

tv monitor, is a self contained unit that operates from either NTSC encoded color video signals or from simultaneous red, blue and green signals. It employs a three-gun, tricolor picture tube of the 21AXP22A type.

All operating and set-up controls, as well as a test point for Y, I, Q, R, G or B signals are accessible from the front. A switch connects the I channel to the red gun and the Q channel to the green gun so that hue and quadrature may be set without the use of an external oscilloscope. Front panel adjustment of field purity is obtained through the use of electromagnetic rim-purity coils fed from a regulated supply.

Overall size is 29 in. high, 27 $\frac{3}{4}$ in. wide and 26 $\frac{1}{2}$ in. deep. Schematics, engineering data and specifications may be had from the manufacturer. Circle P46 inside back cover.

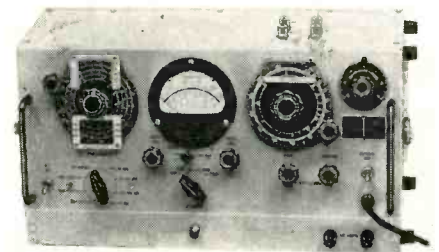

Q METER
has varied applications

ALPHA INSTRUMENT Co., 43 Hempstead St., New London, Conn. Model 162 Q measuring instrument uses no special tubes, has no thermocouple to burn out, and it is almost impossible to damage the indicating meter with over-

why companies find it
GOOD BUSINESS
 to specify panel instruments
 by *Simpson...*

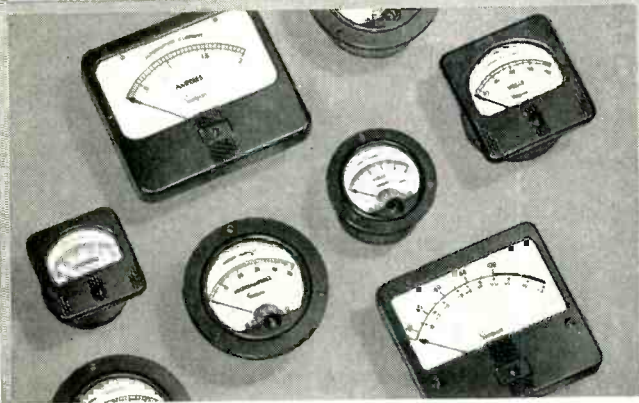

... QUICK SERVICE from HUGE STOCKS!

Over 50,000 stock units, in 800 sizes and types, are available through 1,500 electronic distributors. Wherever you are located, Simpson instruments are obtainable promptly.

CORE MAGNET METER MOVEMENT

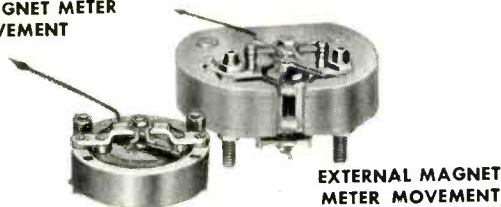

... EXACT NEEDS CUSTOM BUILT!

Many meters quickly built from *standing tools*, or designed to your exact specifications. Firm delivery schedules. Movements include the superb, *self shielded* Core Magnet Meter Movement.

● Simpson instruments have established a reputation for laboratory accuracy... yet they have the ruggedness to stand up under years of service and severe shocks. Write for new catalog.

SIMPSON ELECTRIC COMPANY

5200 W. Kinzie St., Chicago 44, Illinois
 Phone: EStebrook 9-1121

In Canada: Bach-Simpson Ltd., London, Ont.



Instruments that stay accurate

Now... a low cost, reliable
SUPERSENSITIVE RELAY

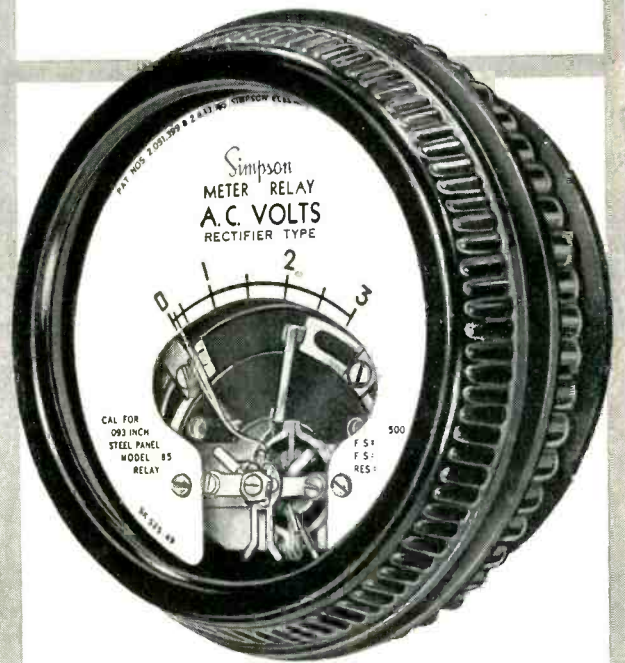

NEW!
Simpson
METER RELAYS
of improved design and reliability

**Less than 50 Millimicrowatts
 Control Up to One Watt!**

Here is a line of improved Meter Relays that offers lower costs, plus circuit simplification for many alarm, control, and limit setting applications. The new design features platinum alloy contacts and increased contact force which minimizes sticking and provides extreme reliability. Simpson Meter Relays are a nonlocking type, currently available in 2" DC and 3" AC and DC models. Write for new Technical Bulletin No. 17, today.

SIMPSON ELECTRIC CO.

5200 W. Kinzie St.
 Chicago 44, Illinois
 Phone: EStebrook 9-1121

In Canada:
 Bach-Simpson Ltd., London, Ont.



INSTRUMENTS THAT STAY ACCURATE

JUST OUT!

An all-inclusive reference work, presenting a wide range of information on all fields of physics

American Institute of Physics HANDBOOK

Now you can save yourself hours of searching through scattered references for the fact or formula you need. Here, instantly available, is the basic physical data so frequently called upon in scientific, engineering, and research endeavors. Sections cover mechanics, acoustics, heat, electricity, optics, atomic and molecular physics, and nuclear physics. Dwight E. Gray, Coordinating Editor. Over 1500 pages, \$15.00.

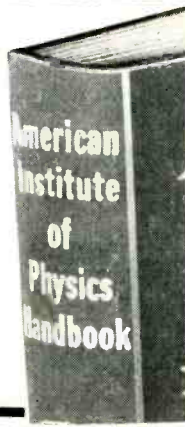

NEW PRODUCTS

(continued)

loads, thus allowing the instrument to be used by inexperienced personnel without fear of damage. Other features are its wide frequency range of 50 kc to 75 mc, internal regulation on both 110 and 220-v operation, an injection voltage of 20 mv that is readily monitored and the use of a single indicating meter that is easily read.

Among the applications of this Q-meter are the measurement of Q of r-f coils and the determination of their effective inductance, measurement of Q of capacitors, insulating materials, coil forms and for incoming inspection and production line testing. Circle P47 inside back cover.



CARRIER AMPLIFIER

with 0 to 1,000 cps response

DAYTRONIC CORP., 216 S. Main St., Dayton 2, Ohio. Model 400A differential transformer amplifier is a highly stable carrier amplifier for use with all differential transformer transducers in dynamic and static measurement of motion, force, weight, pressure, acceleration and similar quantities. The demodulated output signal is suitable for cro's, null-balance recorders, galvanometer oscillograph amplifiers, vtvm's and similar devices.

An internal eight-kc oscillator provides transducer excitation. Frequency response is from 0 to 1,000 cps. Maximum sensitivity is 500 mv/0.001 in. using a typical transducer. Combined noise level and uncorrected zero drift are equivalent to 10 μ in. per hour at maximum gain. Zero set and gain controls are provided on the front panel. It is available in portable or rack mounted styles. Weight

MATHEMATICS and COMPUTERS

Just Out. Shows how modern computers are solving problems for the scientist, the engineer, and the businessman. Explains computer construction and operation and how to formulate problems for them. Points out the advantages of the analog or "continuous" computer for solving problems where only quantitative information is required. By G. R. Stibitz, Consultant, and J. A. Larrivee, Assoc. Professor, Worcester Polytechnic Institute. 225 pages, illustrated, \$5.00.

PROFESSIONAL ENGINEER'S EXAMINATION QUESTIONS and ANSWERS

Over 500 questions and complete answers to help engineers pass state license examinations. Covers mechanical, electrical, civil, and chemical engineering, and includes engineering economics and land surveying. Latest questions—suitable for all states. Author has worked on New Jersey examination preparation for 19 years. By William S. Lalonde, Jr. 462 pages, 234 illustrations, \$6.50.

PULSE and DIGITAL CIRCUITS

Tested methods of working with all types of pulse and digital circuits, to help meet the engineering requirements of today's electronic equipment. Expert, down-to-earth guidance helps you analyze every circuit—shows how each is designed—how it functions. Covers the full range of circuits used in computers, radar, television, and telemetering. By Jacob Millman, Columbia U., and Herbert Taub, C.C.-N.Y. 687 pages, 872 illustrations, \$12.50

Announcing— NEW McGRAW-HILL BOOK CATALOG

Just off press—catalog describes over 3000 books, all subjects, to help you advance, solve problems. Send 25¢ for mailing costs; catalog free. Check at right.

Handbook of INDUSTRIAL ELECTRONIC CONTROL CIRCUITS

Here are the circuits (over 400) you need for sorting, timing, measuring, and counting; for sweep control, triggering and hundreds of other industrial uses—each with concise description, performance characteristics, etc. By Markus and Zeluff. Electronics magazine. 352 pages, 412 diagrams, \$8.75

Handbook of INDUSTRIAL ELECTRONIC CIRCUITS

A companion volume to the above. Contains 433 different industrial electronic circuits for immediate practical use. Each circuit has a clearly drawn diagram and brief, comprehensive description. By Markus and Zeluff. 272 pages, 433 diagrams, \$7.50

FREE EXAMINATION COUPON

McGraw-Hill Book Co., Dept. L-3
327 W. 41st St., New York 36, N. Y.
Send me book(s) checked below for 10 days' examination on approval. In 10 days I will remit for book(s) I keep, plus few cents for delivery costs, and return unwanted book(s) postpaid. (We pay delivery costs if you remit with this coupon; same return privilege.)

- American Inst. of Physics Hdbk., \$15.00
- Stibitz & Larrivee—Mathematics and Computers, \$5.00
- Lalonde—Prof. Engrs. Examination Questions and Answers, \$6.50
- Millman & Taub—Pulse and Digital Circuits, \$12.50
- Markus & Zeluff—Indust. Elect. Control Circ., \$8.75
- Markus & Zeluff—Indust. Elect. Circuits, \$7.50

Send 1957 Catalog, I enclose 25¢

Name
Address
City Zone State
Position
Company
For price and terms outside U. S., write McGraw-Hill Int'l. N. Y. L-3

NEW! FM Telemetering ultra-stable Discriminator*



*Epsco Model FM-108
FM-to-Voltage Converter.



EPSCO'S MODEL FM-108 crystal-controlled ultra-stable, all-channel discriminator presents a new *standard of accuracy* . . . better than an order of magnitude more accurate and stable than any other commercially available equipment . . . and with absolutely *no adjustments!* This new standard of FM data processing features:

- ▶ **HIGH DYNAMIC ACCURACY:** Absolute accuracy is better than 0.05%, and the dynamic accuracy of the equipment from input to associated band-pass filter through the low-pass output filter is better than 0.2%.
- ▶ **LONG-TERM STABILITY:** 0.2% for life of equipment with no adjustments for zero drift, gain and line voltage variations, etc.
- ▶ **VERSATILITY:** Converter operates on any of 23 standard IRTWG telemetering sub-carrier frequencies from 400 cps to 70kc. Band switching may be accomplished remotely or by selector switch on front panel.
- ▶ **AUTOMATIC WOW and FLUTTER COMPENSATION:** With Epsco FM-106 Velocity Deviation Detector and Epsco CD-601 Velocity Deviation Compensation Distributor, errors from tape speed variations are reduced by a minimum of 35 db.
- ▶ **ZERO and 100% DATA CORRECTION:** Produces automatic compensation for variation of transmitting sub-carrier oscillator frequency and gain by a transistorized electro-mechanical servo feature.
- ▶ **DYNAMICALLY ACCURATE SELECTABLE LOW-PASS FILTERS:** A 5-pole filter utilizing precision wire-wound resistors and ultra-stable polystyrene capacitors in combination with chopper-stabilized d-c amplifiers provides:
 - Phase linearity deviation not exceeding 0.25 degrees over 90% of bandwidth.
 - Pass band flat within $\pm 0.1\%$ (0.01db) to F_c .
 - Minimum attenuation of 54 db of nearest beat frequency between sub-carrier channels.
 - A total of 62 different low-pass filter bandwidths selectable from 11 cps to 3490 cps.
- ▶ **PHYSICAL CHARACTERISTICS**
 - SIZE:** 10½" of space of standard 19" cabinet.
 - WEIGHT:** 29½ pounds.
 - CONSTRUCTION:** Constructed of 8 separate plug-in chassis assemblies containing electronic and magnetic components. All components are accessible on the standard layout forms.

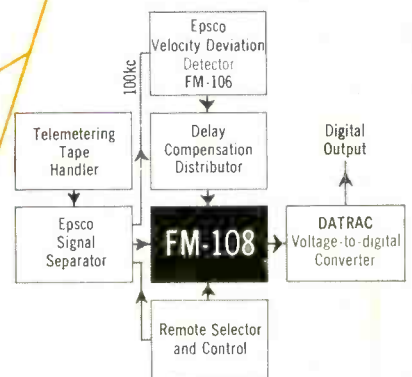

Epsco Model BF-601 Signal Separator units, each of which contains 23 band-pass filters, are available for separating the composite sub-carrier signal prior to input to FM Converter.

Complete FM telemetering receiving stations are available with or without wow and flutter compensation and zero and 100 percent correction features. Also available is the Epsco Model VCO-718 All-Channel Voltage-Controlled Oscillator for FM Discriminator calibration . . . which occupies only 3½ inches of panel space including power supply.

Engineering data sheet available on request.

In the West, contact:
Epsco Service Corporation of California
1722 Westwood Boulevard
Los Angeles 24, California

Epsco

incorporated

588 COMMONWEALTH AVE.

BOSTON 15, MASSACHUSETTS

is 13 lb. Circle P48 inside back cover.

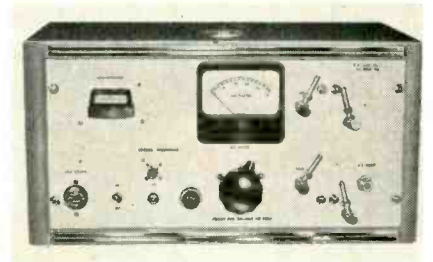

CALORIMETER BRIDGE
continuously self-calibrated

ELECTRO - IMPULSE LABORATORY, INC., 208 River St., Red Bank, N. J., announces a new direct reading calorimeter bridge with frequency range of d-c to 4,000 mc (coaxial) and 1,000 to 12,000 mc (waveguide). It is continuously self-calibrated by an auxiliary a-c standard load and an a-c wattmeter. The vswr of the r-f load resistor is less than 1.25, up to 4,000 mc. Total error in power measurement is less than five percent. Accuracy can be increased by calibrating the instrument against an accurate laboratory type a-c wattmeter.

Power range is 10 to 150 w, 10 to 500 w, and 100 to 5,000 w. Power supply is 115 v, 60 cps, single phase, 250 w. Descriptive literature is available. Circle P49 inside back cover.

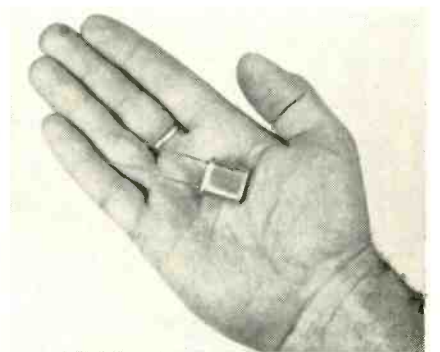

SNAP-ACTING THERMOSTAT
highly shock resistant

METALS & CONTROLS CORP., Attleboro, Mass., presents a new Klixon snap-acting, disk-type thermostat for applications where maximum shock and vibration resistance are required. These controls feature the Spencer disk thermal element,

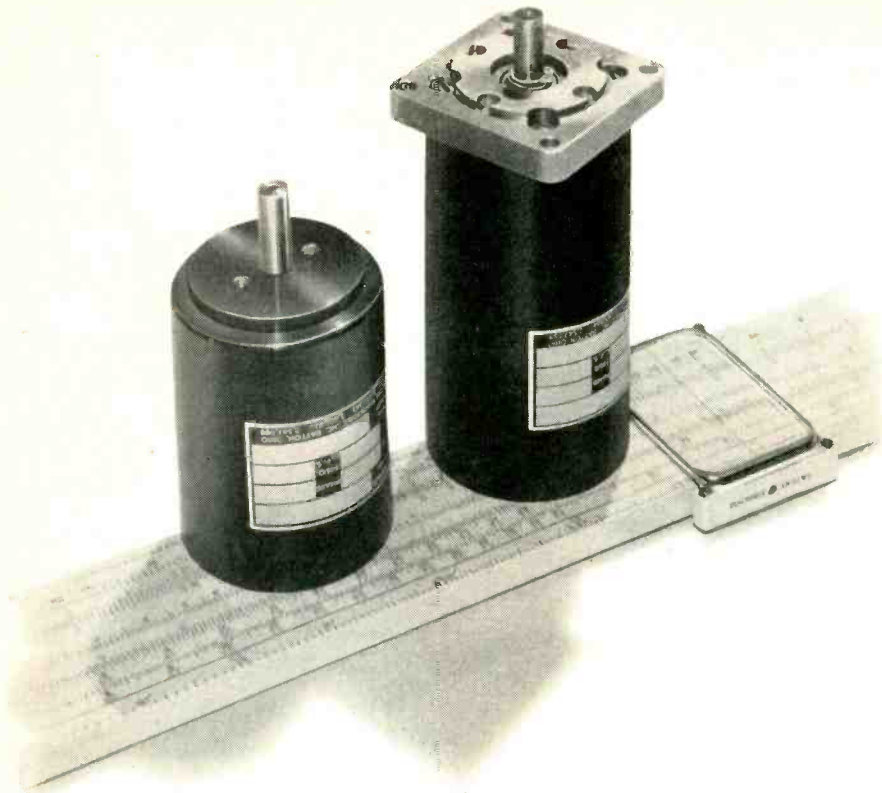

NEW A. C. MOTOR LINE
GIVES YOU 10⁵
STANDARD VARIATIONS

From Globe you can get fast delivery of complete miniature power systems designed around new FC motors—115 or 200 V.A.C., 60 or 400 cycles—induction, hysteresis, or dual speed rotors, wound 3 phase, 2 pole or 4 pole; 2 phase, 2 pole or 6 pole; single phase with a matched capacitor. Units are designed to meet MIL specs; operating characteristics and configuration can be modified.

Package can include integral gearing, either planetary or spur. Choose from 102 standard ratios from 4:1 to 3,000,000:1. Choose from 408 stand-

ard speeds. Gear units range in length from 1.043" to 1.953". WRITE FOR FC BULLETINS.

Globe's small AC motor packages are built around units 1.07" dia., 1.25" dia., and the newest 1.675" dia. x 2.250" long. Standard modifications in type, winding, gearing, and performance offer you millions of combinations at reasonable cost. Globe also makes D.C. governed and gear reduced motors, servo motors, actuators, timers, generators, gyros, blowers, fans, and control systems. **GLOBE INDUSTRIES, INC.** Dayton 4, Ohio

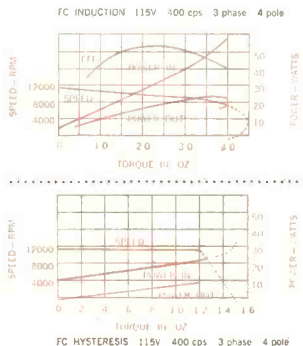

TREPAC[®] MODEL 530

TELEPRINTER RELAY ELIMINATOR PACKAGE

The Model 530 Trepac is a fairly simple plug-in electronic device composed basically of a silicon-diode power-transistor switch and full wave rectifier circuit. It is powered directly from the 115 Volt AC, 50/60 cycle line. Normally it is installed within the housing of the teletypewriter machine where its use obviates the need for a line relay and power supply and simplifies the wiring of the printer table and base. As a static unit having no moving parts, the Trepac requires no adjustment and is, for all practical purposes, maintenance-free. The useful life of this unit will greatly exceed the life of any relay currently on the market.

ATTENTION: TELEPRINTER USERS
NOW FOR AS LITTLE AS \$39.85 YOU CAN ELIMINATE YOUR

- LINE RELAY ● RECTIFIER
- CURRENT LIMITING RESISTORS
- SPARK SUPPRESSING FILTER
- PRINTER TABLE WIRING

SUPERIOR PERFORMANCE — REDUCED MAINTENANCE

THE OLD WAY Teleprinter users have for some years inserted the selector magnet of their printers directly in the incoming signal loop. This has proved troublesome, since the inductive kick of the printer magnet is induced back into the receiving line disturbing other equipment on the loop.

This inductance causes wear on the transmitting contacts, and will in many cases intolerably restrict the range limits of the monitor printer equipment. The inductive overshoot makes it difficult to obtain true distortion test readings and confuses oscilloscope observations.

AN IMPROVED WAY Some improvements in teleprinter performance have been obtained by substituting holding type selector magnets for the older pulling type magnets. Improvement can also be obtained by connecting the holding type magnets in parallel to reduce the overall inductance. Even with these improvements, teletypewriter users generally have found it necessary to interpose a relay to repeat the signal and block the inductive feedback. The use of relays, however, produces many other difficulties. The relay coil is itself inductive and the large inductive kick of the selector magnet is present on the relay contacts producing arcing, sparking and wear. The use of a relay, with its many troubles, has resulted in a maintenance problem which has plagued the industry. Distortion introduced by a relay is rarely less than 2% even with new, properly adjusted relays, and the bias current requires adjustment whenever the loop current changes.

THE NEW WAY By using the Model 530 Trepac, the advantages of a relay are gained without accruing any of its numerous disadvantages. The Trepac has an almost pure resistive input, and accordingly gives ideal isolation between the printer loop and the printer selector magnet. It maintains true and accurate repeating of the telegraph signal.

A Trepac will operate with either 20 or 60 ma. signal loop input (polar or neutral keying of either polarity). The output current to the selector magnet is nominally 60 ma. and is insignificantly changed for large variations in the input signal loop current. The distortion is always negligible.

The resistive input and the isolated output characteristics make it possible to insert as many as 15 Trepac equipped monitor printers in one signal loop without any one printer affecting the range limits of any other printer. The life of the transmitting device (contacts or vacuum tubes) is greatly lengthened as a result of the removal of inductance from the signal loop. This reduction of L:R ratio also makes feasible the operation of Trepac-equipped printers from a low voltage battery applied to the signal loop.

SPECIFICATIONS

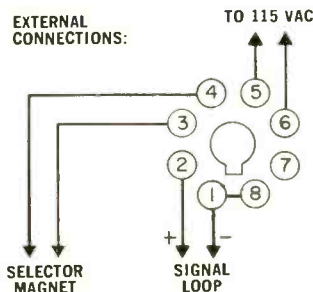

(See Bulletin 530B for bracket and cable assemblies available for installation of Model 530 Trepacs)



INPUT: Pins 1 & 8 connected: 45 to 100 ma, 195 ohms (resistive). 1 & 8 not connected: 15 to 40 ma, 560 ohms (resistive). Polar or neutral keying (either polarity). 9 VDC min. loop supply.

OUTPUT: 55-70 ma into 210/177/44 ohms inductive. Drives pulling or holding magnets (series or parallel connected). Neutral on-off output current constant over above range of input currents.

POWER: 105-125 VAC, 50/60 cps, instant warm-up. May be connected to printer motor switch to stop relay action when motor is off.

PHYSICAL: Steel can with side ventilators. 3 1/16" W x 2 1/16" D x 4 1/4" H seated. Weight: 19 ounces. Mounting: 4 studs 1/2 by 1/2" on 2 3/8" x 2" centers. Finish: Baked Hammertone Gray.

TEMPERATURE: 20 to 130°F. Tests reveal that temperature within a printer near the line relay is generally 101 to 107°F. This area is specified for mounting of the Trepac.

KEYING SPEED: Capable of operating well into kilocycle range. Limited only by speed of selector magnet (125 wpm).

DISTORTION: Negligible (under 1%). No distortion introduced by varying loop current.

SPECIAL FEATURES: Units will deliver STEADY MARK current (nominally 60 ma) regardless of input keying state when pin 7 is tied to pin 3 on mating socket. This is extremely useful for: (1) use of the Trepac as a rectifier to provide 60 ma loop current, and (2) testing and maintenance of the teleprinter (without printer running open) when it is not desirable to interrupt the signal loop. All connections are isolated from the chassis. Trepacs are designed to withstand the shock and vibration normally present in teleprinters. Protection against dust, grease, moisture and fungus is provided by a fungicide chemical coating on all components in the Trepac.

ONE YEAR WARRANTY: Defective units will be replaced, provided they have not been tampered with and have been used for their specified purpose within the above ratings. Trepacs returned to Alcor should be accompanied with a report of their trouble.

QUANTITY — UNIT PRICE — DELIVERY

2-24	\$39.85	stock
25-99	38.50	1 week
100-249	37.25	1-2 weeks
250-999	36.00	2-6 weeks
1000-2499	34.85	6-10 weeks

FOB: New York, N. Y.
Terms: 1/2% - 10, net-30

ALCOR ELECTRONICS CORPORATION
180 LAFAYETTE STREET • NEW YORK 13, N. Y.

NEW!

ECCO COMPUTER-SERIES PLUG-INS

...a refinement of the building-block concept to a degree hitherto unknown, with each circuit a complete off-the-shelf packaged function.

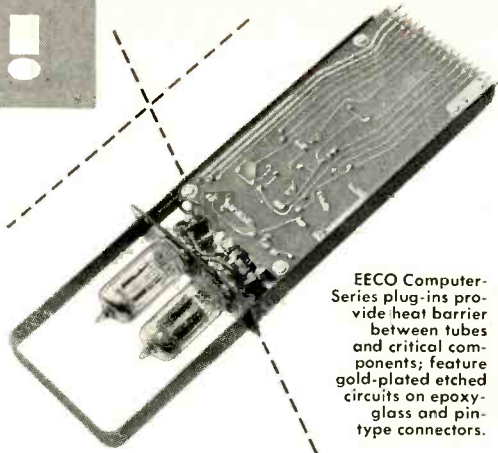

ECCO Computer-Series plug-ins provide heat barrier between tubes and critical components; feature gold-plated etched circuits on epoxy-glass and pin-type connectors.

Originally developed for ECCO custom systems and proven in critical use, this compatible series of digital and logic circuits is now available to the industry. Meet your project delivery schedules by reducing system-development time to a bare minimum and virtually eliminating drafting and layout time.

PERFORMANCE ECCO Computer-Series plug-ins are performance engineered for application where ultra-conservative design at the component level is essential because of system complexity. System prototypes can generally be built directly, without need for the "breadboard" stage.

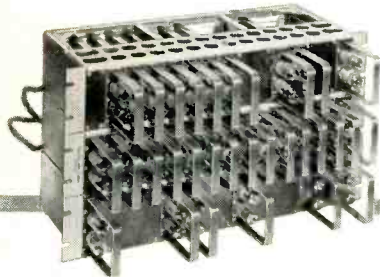

Three Mounting Frame Assemblies were stacked to house this Output Shift Register. Each Mounting Frame accommodates 15 plug-ins, is 3 1/2" x 19" for installation in 19" rack.

Quick-Look section of ECCO-built Project Datum installation at Edwards Air Force Base shows typical modular assembly of Computer-Series plug-ins

Rear view of Output Shift Register shows simplicity of point-to-point wiring.

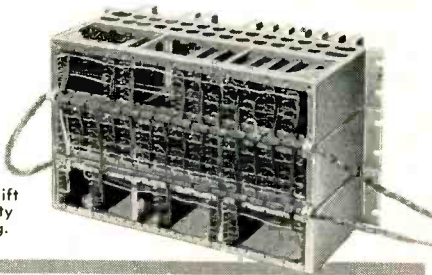

*** QUICK FACTS:** Tube dissipation de-rated 75%; cathode current de-rated 50%. 1% components used where 5% required and 5% where 10% required. Reliable operation with $\pm 20\%$ change in filament voltage, 30% change in tube transconductance. Isolating diodes on multiple inputs eliminates crosstalk. Low output impedance—in general, cathode follower. (One flip-flop will trigger another at the end of a 50-foot length of twisted pair!) Signal levels clamped. Computer-type tubes. Circuit trouble-shooting already done; layout basically completed. Packaging, heat-barrier, and ventilation problems solved. In-circuit test fixture available

CIRCUITS You can concentrate on the design of systems, knowing you have available a full line of reliable, tested, and proven circuits, including:

- | | |
|-------------------------|-------------------------------|
| Flip-Flops | Quadruple Cathode Followers |
| Shift Register Elements | One-Digit Adder Matrixes |
| DC "NOT" Circuits | One-Digit Subtractor Matrixes |
| Delay Units | One Shots |
| Pulse Mixer Amplifiers | Neon Drivers |

plus 28 Diode Logic Units incorporating "And" and "Or" circuits. In addition, ECCO stands ready to design diode logic circuits and produce plug-in units to yield any equation you may require. In short, custom-built logic to order—quickly!

*Detailed information on new Computer-Series plug-ins, as well as on Standard-Series plug-ins, Systems Development Racks, Power Supplies, D-C Amplifiers, and other ECCO products is available in Catalog No. 856-A. Write for your copy—today.

ELECTRONIC ENGINEERS AND PHYSICISTS—ECCO offers immediate opportunities for qualified engineers in the transistor, amplifier, data-handling, pulse, timing, and systems-design fields. Send a resume of your qualifications to R. F. Lander, Dept. CS.

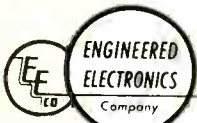

ENGINEERED ELECTRONICS COMPANY

a subsidiary of Electronic Engineering Company of California

506 EAST FIRST STREET SANTA ANA, CALIFORNIA

NEW PRODUCTS

(continued)

fine silver electrical contacts, and a complete hermetically sealed assembly. A copper-nickel plated steel casing protects all parts from contamination and moisture to assure precise circuit operation. Application is especially recommended in aircraft controls and guided missiles. A wide range of possibilities also exists in electronic circuits and components and servomechanisms.

The C7216 thermostat is specially plated for corrosion resistance. Its miniature size suggests its suitability where space and weight accommodations are limited. Standard temperature settings which are fixed, range from -20 F to 400 F. It is available with No. 20 copper wire leads. Circle P50 inside back cover.



SERVO ACTUATOR for airborne applications

WHITE-RODGERS ELECTRIC Co., 4407 Cook St., St. Louis 13, Mo., has developed a D-9 p-m type rotary servo actuator for airborne applications. It is designed for continuous operation at an output rating of 70 in.-lb at 8.5 rpm. Theoretical acceleration at stall is 40,000 radian/sec² and dynamic motor braking is incorporated. The unit has a weight of 1.9 lb, diameter of 3 1/8 in. and an overall length of 4 1/2 in., including the AN connector.

The unit features limit and centering switches and a potentiometer for feedback of position information. The servo meets applicable military specifications including MIL-E-5272A and MIL-

I.R.E. Show, Booths 3806 - 3808

See "CAVALCADE OF ELECTRONICS"



International Silicon Diodes

Over 600 types

in full production!

PIV ratings up to 16,000 volts . . .

for high reliability

over a wide temperature range



Write on your letterhead for bulletins on any or all types illustrated. If you have a particular problem, our Application Advisory Group will be happy to submit a prompt evaluation and recommendation.

International Rectifier

C O R P O R A T I O N

EXECUTIVE OFFICES: EL SEGUNDO, CALIFORNIA • PHONE OREGON 8-6281
NEW YORK: 132 E. 70TH ST., TRAFALGAR 9-3330 • CHICAGO, 205 W. WACKER DR., FRANKLIN 2-3889
IN CANADA: ATLAS RADIO CORP., LTD., 50 WINGOLD AVE. W., TORONTO, ONTARIO, RU 1-6174

THE WORLD'S LARGEST SUPPLIER OF INDUSTRIAL METALLIC RECTIFIERS

CO-AXIAL SWITCHES, MICROWAVE TEST EQUIPMENT and PRIMARY POWER STANDARDS

NEW PRODUCTS

(continued)



PULSE POWER CALIBRATOR

MODEL PCX-1 PULSE POWER CALIBRATOR is an extremely precise instrument for calibrating pulse power measuring devices in the 925- to 1225-mc frequency range and for measuring power between -10 and +63 dbm to within 0.5 db. It is the first in a series which includes similar calibrators designed for the 3000-mc, 5000-mc and 9000-mc bands.

This equipment employs a new method which permits far greater accuracy (other than calorimetric) than heretofore achieved. It establishes a measurement reference level at the time of each use. Ease of operation is assured by the notch-and-reference-line display, by the automatic centering of pulses on the display, and by the direct reading of power measurements. The removable bisecting cover, frame construction, hinged and pivoted subchassis assure easy accessibility for servicing.

I-6181B. Circle P51 inside back cover.

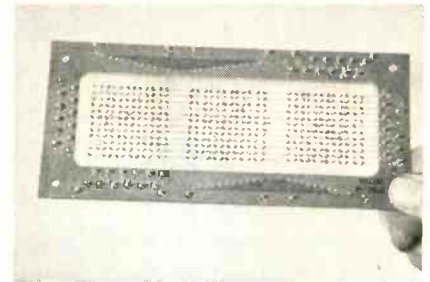

MAGNETIC STORAGE multiple matrix type

VALOR ELECTRONIC COMPONENTS Co., 5808 Marilyn Ave., Culver City, Calif. Illustrated is a multiple magnetic storage matrix built so all respective X and Y lines are connected in series through each of the separate matrices, but makes available separate sense and inhibit lines for each of the three. This construction offers economy in installation of a matrix store as well as in space required.

Ordinarily a 144-word, 15 digit-per-word storage system would require fifteen 12 by 12 conventional matrices having 28 sets of interconnecting lines. Using the 12 by 12 by 3 matrix shown, only five planes would be required, and it would be necessary to interconnect only eight sets of lines.

The multiple matrix construction is readily adapted to matrices of up to 16 by 16, and as such will find wide use in small computers, as well as buffer storage systems. Circle P52 inside back cover.

SYNCHROS to military standards

NORDEN-KETAY CORP., Commerce Road, Stamford, Conn. The new 3-minute size 23 synchros meet all performance requirements and provide at least twice the accuracy specified in FXS 1066, Rev. 4, MIL-S-16892 (Bu Ord) and MIL-S-12472 (Ord.). They are especially valuable in airborne applications requiring accuracy with minimum bulk and weight.

The units are engineered to en-



MINIATURIZED SWITCHES

A new line of inexpensive, miniature, light-weight, versatile co-axial switches.

GENERAL CHARACTERISTICS

Frequency Range: 0 to 10,750 mc/s. VSWR: 1.25 at 3000 mc/s - 1.5 at 10,750 mc/s. Insertion Loss: 0.25 db up to 9000 mc/s. RF Power Rating: 100 watts average - 1500 watts peak. Voltage Rating: 500 volts peak. Crosstalk: greater than 70 db up to 9000 mc/s. Impedance: 52 ohms nominal. Actuator Voltage: 28 volts DC nominal. Actuator Power: 10 watts average continuous. Operative Life: 100,000 cycles. Operating Temperature: -55° C to +85° C. Connector Type: N, BNC, or C. Weight: 10 ounces. Dimensions: 2.5 in. x 2.875 in. x 0.875 in. Switching Arrangement: SPDT. Mounting Features: Mounts flat against panel, chassis or frame; multiple-stacked compactly.



MANUAL CONTROL SWITCHES

Compact, lightweight - available in Radial; parallel connector configuration.

GENERAL CHARACTERISTICS

Frequency Range: 0 to 10,500 MC. VSWR: 1.2:1 max. at 3000 MC. Insertion Loss: 0.3 db max. Crosstalk: greater than 60 db at 3000 MC, greater than 40 db at 10,500 MC. Operation Life: 10,000 cycles, min. Construction: weatherproof. Connectors: N, BNC, C, HN, BN, LN. Positions: 2, 3, 4 and 6: single and double pole. Easily adaptable for specialized usage.



REMOTE CONTROL SWITCHES

28 V. DC., 110 V. DC. - Compact, lightweight - available in Radial, spring return; Radial, transfer; parallel connector configuration. 115 V. AC., 60 cycle. - Compact, lightweight - available in Radial, spring return; parallel connector configuration.

GENERAL CHARACTERISTICS - See Above



"S" BAND BEACON

A highly miniaturized receiver-transmitter for missile applications to facilitate radar tracking. Supplied with power supply, cable and antenna (not shown).



"X" BAND TEST EQUIPMENT

TEST SET BHS (AN/UPM-10A)

A portable microwave signal generator for testing and adjusting beacon equipment and radar systems operating in the range of 8500 to 9600 MC. Measures power and frequency of external signals. Supplies pulse-modulated, square-wave-modulated or unmodulated signals of known power and frequency. Also supplies frequency-modulated signals.



NEW! MODEL BDX FOR GREATER ACCURACY

Greater frequency accuracy (± 1 mc from 8500 to 9600 mc). Greater power level accuracy (± 1.5 dbm without correction curves). Repetition rates high enough to measure recovery time with assurance (up to 50,000 PPS). Operates with or without an auxiliary trigger. More rugged and dependable. The only complete signal tester for beacon work.



GENERAL COMMUNICATION COMPANY

681 Beacon Street, Boston 15, Massachusetts

BOOTH 3063 - IRE SHOW - NEW YORK



Better Things for Better Living
through Chemistry

ELECTRONIC DESIGN

LATEST PROPERTY AND APPLICATION DATA ON

TEFLON[®]

tetrafluoroethylene resin

NEWS

Du Pont TEFLON[®] resists temperature extremes in electronic aircraft equipment

Lead-through bushings of TEFLON[®] feature hermetic sealing



LEAD-THROUGH BUSHINGS made with DuPont TEFLON have excellent corona, arc and ohmic resistance . . . are hermetically sealed against gases, vapors, liquids. (Manufactured by the Joclin Manufacturing Company, North Haven, Connecticut.)

Sensitive tests with the mass spectrometer have proven that gases, conventional insulating oils, silicone oils and their vapors cannot penetrate through connectors using TEFLON tetrafluoroethylene resin as their dielectric. The bushings maintain their seal when cycled repeatedly over a temperature range from -85° F. to +302° F.

In addition, the connectors are resistant to shock. The specially prepared insulators of TEFLON provide mechanical resilience not possible with the usual rigid construction. The moisture-repellent qualities of TEFLON make it possible to use the bushings under the most adverse conditions of humidity. They conform to the applicable sections of Specification MIL-E-5272A.

Where components are subjected to a wide range of temperature, pressure, humidity and mechanical shock and vibration, DuPont TEFLON provides outstanding performance. In your designs, too, components of TEFLON may well be the decisive factor in meeting acceptance standards.

Wire insulated with TEFLON is used in new transistorized flight-control system

The transistorized PB-20 is the latest development in the field of automatic flight-control equipment. It has been specified for use in many advanced aircraft, such as the Boeing 707 jet transport. The PB-20 depends extensively on wire coated with TEFLON for reliable operation.

Tough and durable TEFLON can be used up to 500° F. and displays excellent properties at sub-zero temperatures. Thin-walled coatings on wire will not burn, melt or decompose when connections next to it are soldered. The dielectric strength and arc resistance of TEFLON are excellent. Its dissipation factor of less than 0.0003 from 60

cycles to 3,000 megacycles assures low losses in high-frequency communications equipment. Very few chemicals exist which can injure TEFLON . . . it is not affected by aircraft fuels, lubricants or solvents. It is inert to fungus, rot and mildew and will not absorb moisture. Articles of Du Pont TEFLON will meet the requirements of many military specifications relative to jet-aircraft applications.

You can meet the increasing demands for extreme temperature range, higher frequencies, higher voltages and greater resistance to corrosive environments by specifying TEFLON. Find out now how TEFLON can improve your products.

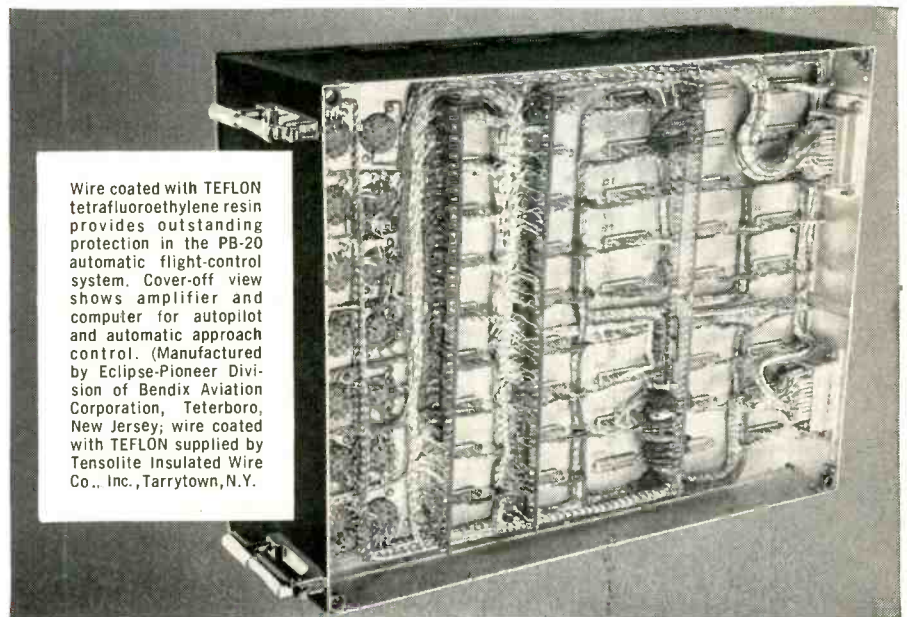

Wire coated with TEFLON tetrafluoroethylene resin provides outstanding protection in the PB-20 automatic flight-control system. Cover-off view shows amplifier and computer for autopilot and automatic approach control. (Manufactured by Eclipse-Pioneer Division of Bendix Aviation Corporation, Teterboro, New Jersey; wire coated with TEFLON supplied by Tensolite Insulated Wire Co., Inc., Tarrytown, N.Y.)

TEFLON[®]

is a registered trademark . . .

TEFLON is the registered trademark for DuPont tetrafluoroethylene resin, and should not be used as an adjective to describe any other product or any component part; nor may this registered trademark be used in whole, or in part, as a trade name for any product.

SEND FOR INFORMATION

For additional property and application data on DuPont TEFLON tetrafluoroethylene resin, mail this coupon.

E. I. du Pont de Nemours & Co. (Inc.), Polychemicals Dept.
Room 173, Du Pont Building, Wilmington 98, Delaware

Please send me more information on Du Pont TEFLON tetrafluoroethylene resin. I am interested in evaluating these materials for _____

Name _____

Company _____ Position _____

Street _____

City _____ State _____

Type of Business _____

In Canada: Du Pont Company of Canada (1956) Limited, P. O. Box 660, Montreal, Quebec

Installed World-Wide for
Greater Wiring Dependability

CHESTER

plasticord-plasticote[®]

WIRES & CABLES

Plasticote Miniature Wire and Cable — single or multiple conductors bare or tinned, solid or stranded copper with thin wall Plasticote insulation.



Plasticote Hook-up Wire — made to conform to the requirements of Specification JAN-C-76 and MIL-W-76A in solid or stranded constructions.



Plasticote Coaxial Cable—(RG/U) to conform to JAN-C-17A and MIL-C-17B requirements are available. Special designs of coaxial cable transmission lines available.



Plasticote Intercom Cable — multiple conductors bare or tinned, solid or stranded annealed copper with tinned copper shield and Plasticote jacket.



See us at the
I.R.E. Show!
Booth 4602

**CHESTER
CABLE CORP.**

60 HILL STREET, CHESTER, NEW YORK

A Subsidiary of Miami Copper Company

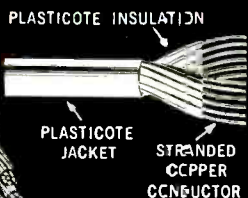

Plasticote Multiple Conductor Cable — multiple conductors (No. 16 AWG to No. 26 AWG) bare or tinned, solid or stranded annealed copper are available.

Easier Working... Super Durable!

Chester Plasticote is the rugged insulation that adds years to wiring life. Super-durable, Plasticote also offers the smooth pliable qualities that make Chester conductors easier to work with. Specifying Plasticote means you raise wiring quality at the same time you increase wiring production! Call or write for wire samples and bulletins.



able design engineers to increase the accuracy in their control and data transmission systems and servomechanisms. In many instances, three-minute synchros eliminate the need for two-speed synchro systems, thereby reducing cost and effecting economies in weight, size, complexity and gearing problems. Matched pairs of synchros are available to provide even greater system accuracy.

Bulletin No. 409 gives specifications, outline drawings and ordering information. Circle P53 inside back cover.

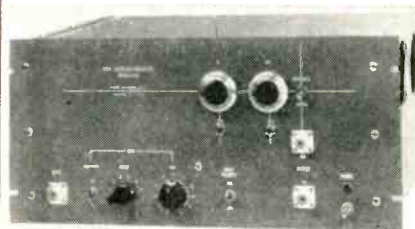

NONOVERLOAD AMPLIFIER and single channel analyzer

HAMNER ELECTRONICS Co., INC., P. O. Box 531, Princeton, N. J., has developed the model N-302, a stable, nonoverload pulse amplifier together with a precision single channel analyzer—all on one standard sized chassis. The amplifier, which employs delay-line clipping and long-tailed pairs with feedback, has good stability, short risetime and excellent overload characteristics. Overloads as large as a factor of 100 are handled easily. The pulse height selector is of advanced design and provides short time resolution, high base

FROM ALL DIRECTIONS . . .

from Virginia from New Jersey from Oklahoma from Pennsylvania from Indiana from Washington, D. C.



Calvin C. Jones
Supervisory Engineer
Virginia Polytechnic
Institute

Frank H. Tyaack
Supervisory Engineer
Massachusetts Institute
of Technology

James L. Van Meter
Supervisory Engineer
Washington State College

John Michael Bentley
Senior Engineer
William & Mary College
Virginia Polytechnic
Institute
Syracuse University

Robert C. Jones
Design Engineer
Purdue University

Leo E. Wilson
Senior Engineer
Carnegie Institute
of Technology

CAREER ENGINEERS ARE COMING TO BALTIMORE TO JOIN THE LEADERS AT WESTINGHOUSE-BALTIMORE

Today's electronic pioneers are reversing the maxim of Horace Greeley to "go West young man." They're coming East, but, they're going Westinghouse . . . and building their careers at Westinghouse-Baltimore. Here, the frontiers of tomorrow's electronic developments are being charted—and here, the young engineer can assure himself rapid professional growth with a company that respects and rewards its engineers. Wherever you are located—whatever school you attended—whatever your engineering experience and ability—you owe it to yourself to investigate the opportunities open to you at Westinghouse-Baltimore. Find out why so many of your fellow engineers have come to Baltimore to join the leaders in the electronics field. Write that letter today—and get the facts. You have nothing to lose—and a great future to gain.

CURRENT OPENINGS EXIST IN:

CIRCUITRY • MICROWAVES • SERVOMECHANISMS
MAGNETIC AMPLIFIERS • DIGITAL COMPUTER DESIGN &
APPLICATION • FIRE CONTROL SYSTEMS • OPTICS
COMMUNICATIONS • PACKAGING • TRANSFORMERS
ANALOG COMPUTER DESIGN • VIBRATION • RADAR DESIGN
FIELD ENGINEERING • INFRARED TECHNIQUES • ANTENNAS
TECHNICAL WRITING • TEST EQUIPMENT • HYDRAULICS
MAGNETRON TUBE EVALUATION • METALLURGY

TO APPLY:

For a confidential interview send a resume of your education and experience to:
Dr. J. A. Medwin, Dept. 621, Westinghouse Electric Corporation, P. O. Box 746, Baltimore 3, Maryland

CAN YOU FILL THIS CAREER OPENING?

ELECTRONIC TRANSFORMER ENGINEERS
—Design and development of audio, i-f and r-f coils, flea-power to 600 x 10⁶ v-a, frequencies up to 1000 MC, both linear and saturable, involving problems of balance, shielding, bandwidth, insulation, heat transfer, wave shape, efficiency and regulation.

SALARY—TO \$9,100.00

WESTINGHOUSE-BALTIMORE

"An Engineer's Company"



line and window stability and low rate dependence. Information on price and specifications is available. Circle P54 inside back cover.



TIME DELAY RELAY

for industry and military

G. C. WILSON & Co., 1915 Eighth Ave., Huntington, W. Va., has available an electronic time delay relay requiring no warm-up and consuming as little as one watt. The hermetically sealed unit was developed for military equipment and is used in guided missile, aircraft and other applications having rigid specifications.

Cold cathode tubes unaffected by vibration are employed in a patented circuit to provide accurate delays down to 3 milliseconds and up to 30 seconds. Designated type EHS, the timer is 2 by 2½ by 3½ in. and weighs nine oz. Circle P55 inside back cover.

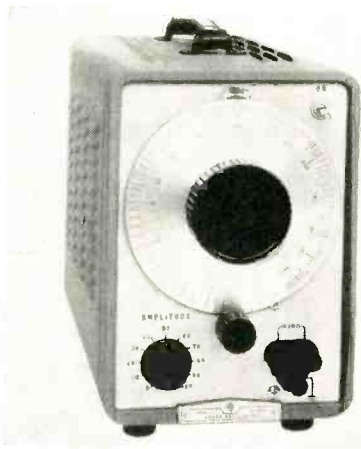

SWEEP OSCILLATOR

covers 5 to 5,000 cps

DYNAC, INC., 395 Page Mill Road, Palo Alto, Calif. The DY-2200 sweep oscillator covers the 5 to

← INPUT

AIRBORNE DIGITAL CODER

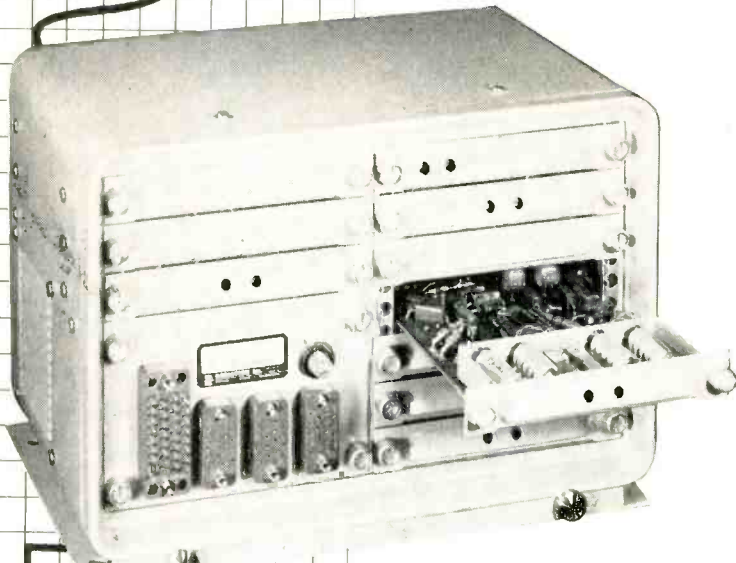

← OUTPUT

PROVIDES 24,000 8-BIT BINARY CODE GROUPS PER SECOND

- All-Electronic
- Accepts 0-10 volt inputs
- Accuracy $\pm 0.4\%$ full scale
- Etched Card Construction
- Volume only 440 cubic inches
- Operates over temp. range -55 to $+71^\circ$ C.
- Weighs only 8 pounds

Write for complete data
and price sheet.

Personnel
Inquiries
Invited



RADIATION Inc.

Melbourne, Fla.
Orlando, Fla.

Electronics • Avionics • Instrumentation

Direct line solution to your closure problems!

ALUMINUM
COPPER
BRASS



Market 3-7584

MU METAL
STEEL
STAINLESS STEEL

A complete solution to your closure problem is as near as your telephone! Chances are, Hudson can supply an economical standard stock item, from factory stocks, that will meet your requirements exactly. Where specifications call for unusual designs, Hudson can produce precision-drawn custom closures to meet your assembly line schedules.

Hudson standard and special closures are available with complete cover assemblies if desired. Quotations on sub-assemblies, including certified spot welding and silver soldering will be supplied promptly on receipt of your drawings and data.

Write or phone for a copy of the Hudson catalog on standard precision-drawn cases and covers

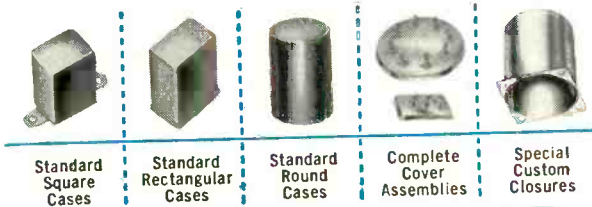

Standard Square Cases Standard Rectangular Cases Standard Round Cases Complete Cover Assemblies Special Custom Closures

HUDSON
TOOL & DIE CO • INC



18-38 MALVERN ST., NEWARK 5, N. J. — Tel. Market 3-7584

Want more information? Use post card on last page.

See us at the I.R.E. Show! Booths 4106-4108

NO TYING! NO DIPPING!

new Varband BONDING TAPE

Bonds and Protects Wires
PERMANENTLY!

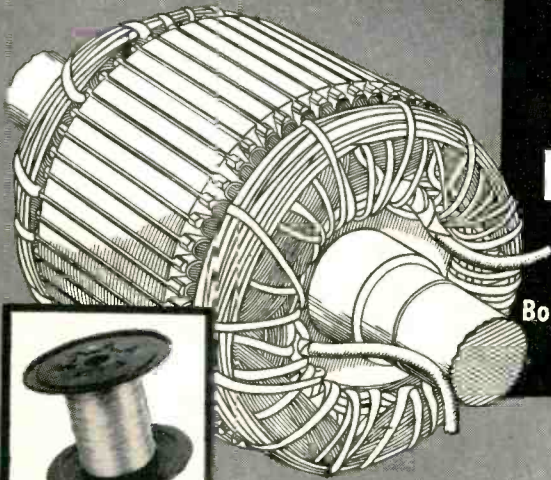

Resists OIL, GREASE, VIBRATION, ACID, VAPOR, HEAT and PRESSURE

Nothing cracks the bond between new Varband Bonding Tape and the wires it holds or encases. That's because Varband Tape is composed of hundreds of parallel strands of Fiberglas which are twisted and impregnated with a special polyester resin. You simply wind Varband Bonding Tape around wires as you would ordinary tape. Soldering iron heat-seals ends

without tying. Then cure (recommended curing is 3 hours at 125° C or less time at higher temperature) . . . and Varband becomes a homogeneous machinable mass that is impregnated not just on the surface . . . but all the way through.

THOUSANDS OF INDUSTRIAL APPLICATIONS Armature banding, core winding, coil supports and stator windings are but a few of the thousands of industrial applications where it pays to use Varband Bonding Tape. Particularly ideal for anchoring wires in vibrating power tools or any wire assemblies that rotate at high speeds.

EXAMINE A SAMPLE TODAY! Available in 6 standard widths, .015" to .030" thick—Varband can also be designed to meet your specific requirements. Send for a sample today.

MANY OUTSTANDING PROPERTIES

Varband Bonding Tape offers you properties far in excess of most other tapes and tying materials . . .

- High Tensile Strength
- High Mechanical Strength
- High Impact Strength
- High Dielectric Strength
- No Interference with Magnetic Field
- No Arc-Over Danger
- High Thermal Stability

Varband Bonding Tape is pre-treated, eliminating separate dipping operation. Steel banding wire end metal shields are no longer necessary. Provides valuable savings! Reduces weight! Cuts application time and cost!

5,000 cps frequency range in one continuous band. This single band eliminates range changing, switching transients and dial discontinuities. It requires no zero setting. The large, easily-read dial is calibrated to a true log scale from 50 to 5,000 cps.

To provide for attachment of mechanical sweeping components and other auxiliary equipment, the DY-2200 tuning shaft extends beyond the rear of the cabinet. The instrument is available in standard rack-panel mounting or in a compact, portable cabinet. Circle P56 inside back cover.

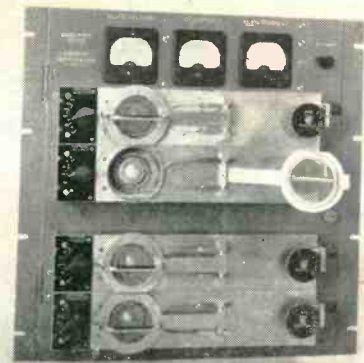

CAVITY AMPLIFIER using 4X150A tetrode

AMTRON CORP., 17 Felton St., Waltham 54, Mass., has announced a new uhf coaxial cavity amplifier using the 4X150A tetrode. This is a unique electrical design which permits the use of standard tuning capacitors. Access for tube replacement is provided by an interlocked door in the front panel.

The illustration shows a four-stage linear amplifier tuning from 300 to 400 mc, with overall gain of 50 db. Other models are suitable for lower frequencies. Circle P57 inside back cover.

SEALED THERMOSTAT miniature, snap action type

VALVERDE LABORATORIES 252 Lafayette St., New York 12, N. Y. Reliability has been built into the design and assembly of the VAL 90 miniature snap action, precision set, sealed thermostat. The setting tolerance is ± 3 F or better and the differential is only

VARFLEX CORPORATION, 506 W. COURT STREET, ROME, N. Y.



Please send me complete information on Varband Bonding Tape.

Name _____

Company _____

Street _____

City _____ State _____

new Formica

See it at the IRE Show
Formica booths 4040-1

CIRPRINT[®]

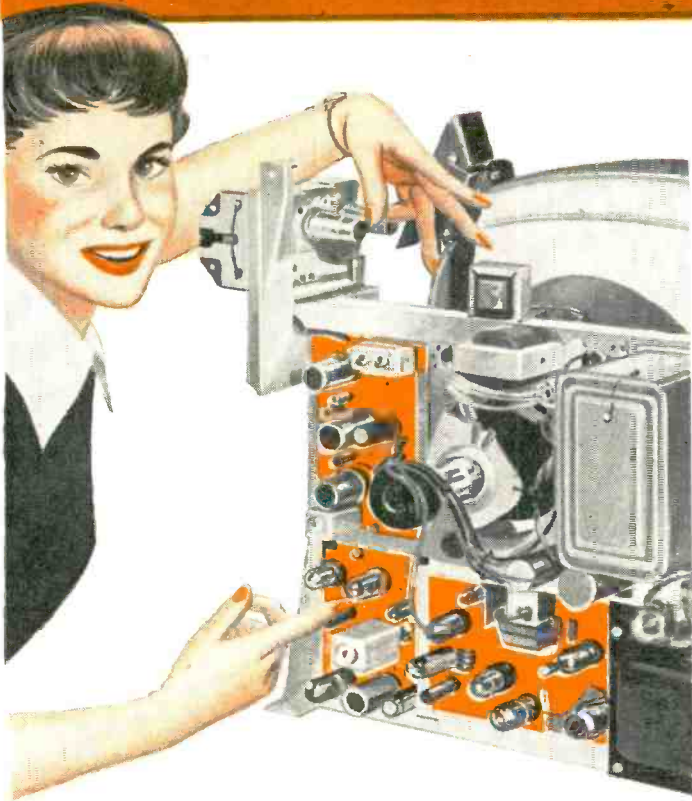

TV - Radio - Phonograph and other electrical/electronic product manufacturers can benefit from Cirprint, the first copper clad laminated plastics ever to offer exactly the right combination of properties for this application. If you're a large volume consumer of circuitry, it will pay you to check Cirprint today.

Exceeds NEMA standards for XXP . . . meets MIL-P-3115B spec for type PBE-P

New Formica Cirprint is far superior to any XXP ever made. The latest product of Formica-4 research, it is the first and only copper clad especially designed to meet the requirements of large volume manufacturers:

High IR: 250,000 megohms after 96 hours at 35°C and 90% relative humidity.

Cold punching: up to and including 1/16".

Low moisture absorption: 0.80% in 1" x 3" x 1/16" sample after 24 hours immersion.

You can see the quality because Cirprint is translucent. Its smooth structure is free of all impurities. Cirprint is also watermarked for your protection.

Evaluate the contribution Cirprint can make to your products. Check it "in person" at Formica's IRE booths 4040-1 — or mail coupon below for free bulletin 755. Formica Corporation, subsidiary of American Cyanamid, 4530-7 Spring Grove Ave., Cincinnati 32, Ohio.

FI-1458

subsidiary of **CYANAMID**



1st choice in laminated plastics

- Application engineering
- Fabricating
- Research
- Customer stock service

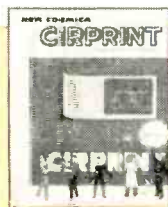

FORMICA CORPORATION

4530-7 Spring Grove Ave. • Cincinnati 32, Ohio

Please send me a copy of Cirprint bulletin 755.

Name _____
 Company _____ Title _____
 Address _____
 City _____ Zone _____ State _____



Official U. S. Air Force photograph

Throws out electron tubes... keeps chopper

Today's aviation electronic standards are often tough to meet. Demands for extreme miniaturization are coming hard on the heels of new reliability and performance standards.

We've heard of one well-known manufacturer, for example, who has gradually eliminated all electron tubes and most other conventional electronic parts from his jet engine control system.

But it's significant that this manufacturer is still using the Bristol Syncroverter® Switch to convert servo signals from d-c to a-c.

The reason? There's no equivalent that comes up to the Syncroverter Switch's performance. Long life and Immunity to Severe Shock and Vibration are outstanding characteristics of the Syncroverter Chopper.

During vibration over the range of 5 cps to 2000 cps and up to 30G, the effect on output waveform is negligible.

Write today for data on this outstanding chopper for your critical signal conversion problems. The Bristol Company, 152 Bristol Road, Waterbury 20, Connecticut.



Bristol Syncroverter Switch.
Covered by patents.

6.73

TYPICAL OPERATION

Driving frequency range: 0-2000 cps (400 cps used for these characteristics)

Coil voltage: 6.3V sine, square, pulse wave

Coil current: 55 milliamperes

Coil resistance: 85 ohms

*Phase lag: $55^\circ \pm 10^\circ$

*Dissymmetry: Less than 4%

*Switching time: $15^\circ \pm 5^\circ$

Temperature: -55°C to 100°C

Operating position: Any

Mounting: Flange or plug-in—fits 7-pin miniature socket

*These characteristics based on sine-wave excitation.

BRISTOL FINE PRECISION INSTRUMENTS
FOR OVER 67 YEARS

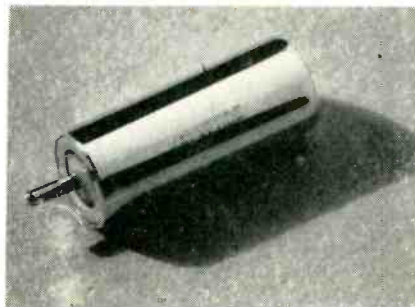

3 F or better. This positive differential, instead of the chatter of the creep type, has several advantages. Commutation is of the best. High g does not cause chatter; contacts are either ON or OFF.

The differential cycle takes a minute or more, totalling about a half million cycles a year compared to over three million cycles for the creep type thermostat if it lasts that long. New degassing techniques before sealing have proven out in practice where reliability is a must. Circle P58 inside back cover.



STEPPING SYNCHRO fits many applications

G. M. GIANNINI & Co., INC., 918 East Green St., Pasadena 1, Calif., has developed a 1-deg stepping synchro. Utilizing an electromechanical positioner to drive the rotor of a differential synchro in fixed increments of 1 deg, these instruments produce an a-c output that is synchronous with rotor position. Rotation of the mechanism is unlimited in both directions, and is operated by an electrical input pulse at any speed up to 60 deg per sec.

Model 89161A-1 stepping synchros have integrated into their design the versatile Rotostepper. Shaft output of the Rotostepper

A Touch here does so much

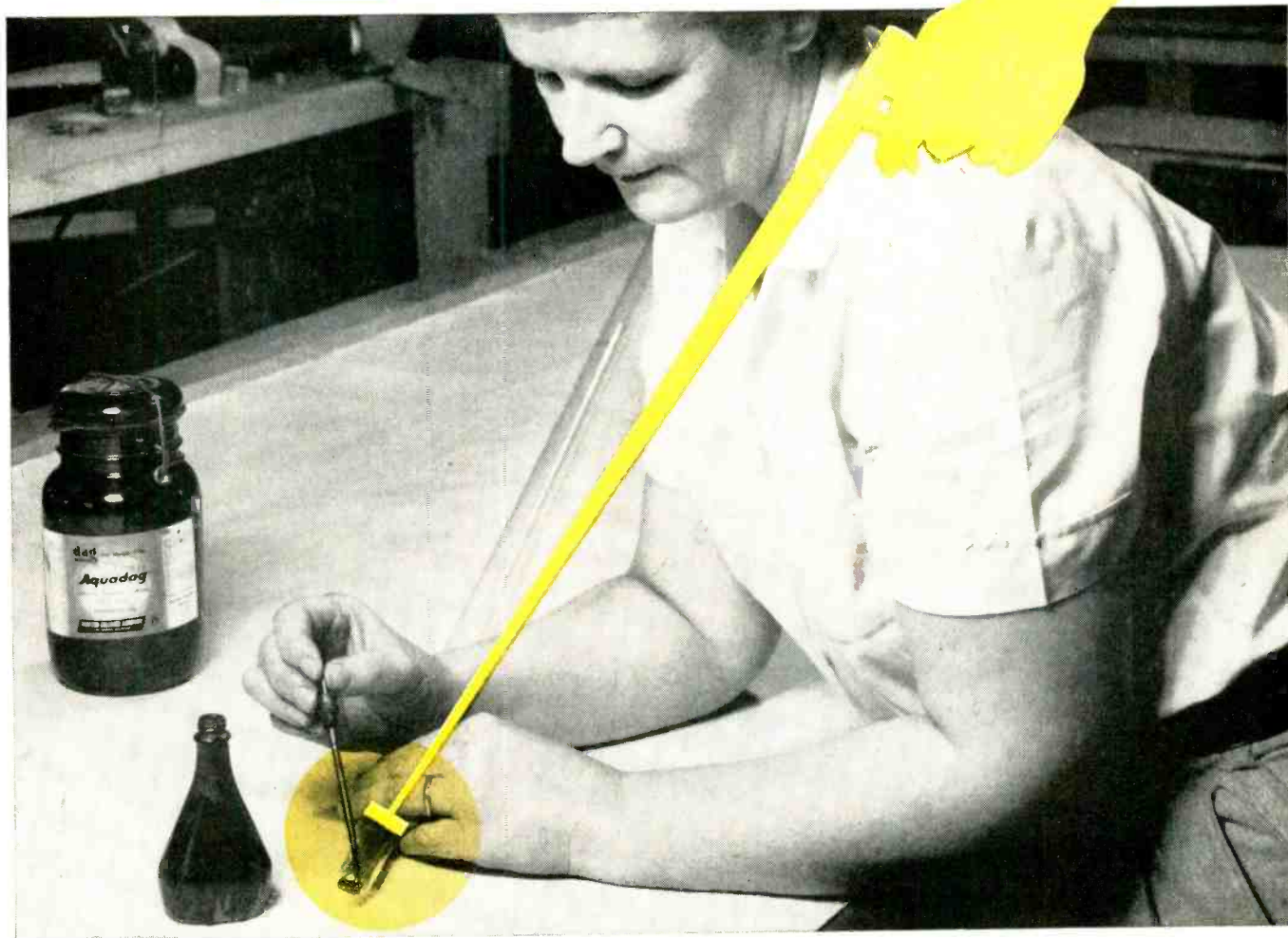

LIGHT UP... SPUTTER OUT...

A touch of 'Aquadag'® between the electrodes of fluorescent tubes makes sputter a thing of the past, greatly increases lamp life and boosts luminosity.

'Aquadag' acts as a "printed" resistor lowering screen-grid potentials so that electrons are repelled and their narrowed beam focussed on the electrode shell. The electric arc occurs behind the shell, dispersing its heat throughout the length of the shell. Lamps last three times as long and give 100% luminosity throughout their life. 'Aquadag', a colloidal dispersion of graphite in water, replaces silver and platinum

which not only are more expensive but so conductive that they soon burn out. 'Aquadag' can be painted on, a faster and more economical method than the soldering of wire.

'dag'® dispersions of colloidal graphite also have good electrical conductivity, are low in photo-electric sensitivity and resistant to electron bombardment.

An Acheson Service Engineer will gladly discuss the many uses for 'dag' colloidal dispersions in electrical and electronic applications. Write for Bulletin No. 433 "Electronic and Electrical Applications." Address Dept. E-3.

dag®

ACHESON COLLOIDS COMPANY

Port Huron, Michigan... also Acheson Colloids, Ltd., London, England

ACHESON COLLOIDAL DISPERSIONS:

Graphite · Molybdenum Disulfide · Zinc Oxide · Mica and other solids

Offices in: Boston · Chicago · Cleveland · Dayton · Detroit · Los Angeles

Milwaukee · Philadelphia · New York · Pittsburgh · Rochester · St. Louis · Toronto



Bourns NEW

TRIMPOT JR. *

- micro-miniature size
- high power rating
- humidity proof

*Trade Mark

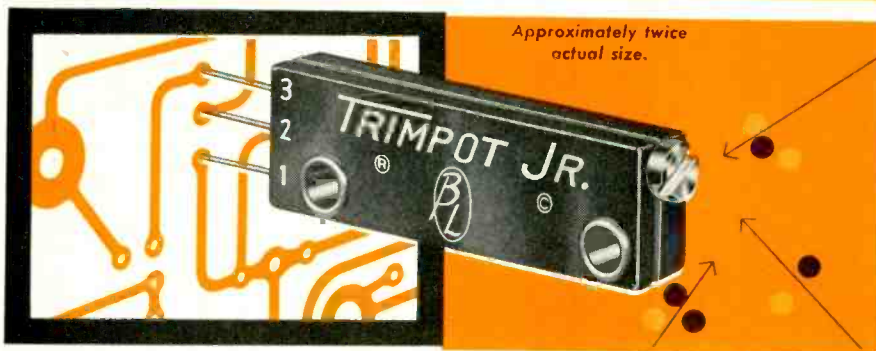

This micro-miniature potentiometer is designed for use with printed circuit boards and modular-type assemblies, and is derived from Bourns' original TRIMPOT.® The new TRIMPOT JR. is only $\frac{3}{16}$ " x $\frac{5}{16}$ " x 1" in size. Seventeen units can be mounted in one square inch of panel space. Power rating is 2 watts, and maximum operating temperature is 175°C.

The TRIMPOT JR. is built to meet or exceed government specifications for humidity, salt spray, vibration, acceleration, and shock. This potentiometer features a 15-turn screwdriver adjustment and $1\frac{1}{2}$ ", 0.016" diameter leads. The shaft-clutch assembly idles when the mechanical limits are reached, thus preventing possible damage from forcing of adjustments. The TRIMPOT JR. is mounted with 2-56 screws through stainless steel eyelets on $\frac{3}{4}$ " centers.

Deliveries from stock. Send for complete data: Bulletin JR.

NEW PRODUCTS

(continued)

is adapted to accurately position the rotor of the precision differential synchro. The unit will fit a multitude of applications such as often found in complex directional or guidance systems where the need exists for servo actuation in precise increments of rotation. Circle P59 inside back cover.

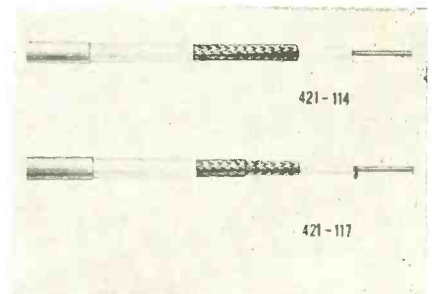

TEFLON CABLES

with nonmagnetic conductors

AMPHENOL ELECTRONIC CORP., Chicago 50, Ill. Types 421-114 and 421-117 coaxial cables are the result of a new Teflon extrusion technique in which the Teflon dielectric is extruded over stranded nonmagnetic silver-plated copper wire. Formerly, only copperweld wire could be used in Teflon extrusion. The new cables are being utilized by several manufacturers where both high temperature and nonmagnetic qualities are desirable. Circle P60 inside back cover.

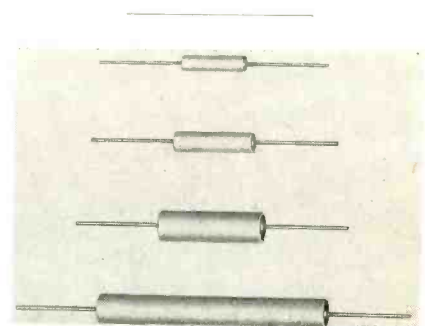

PRECISION RESISTOR carbon film type

CONTINENTAL CARBON, Division of Wirt Co., 13900 Lorain Ave., Cleveland 11, Ohio. A new precision resistor is recommended for use in test equipment, meters and h-f circuits. New type construction features a layer of pure carbon deposited on a ceramic rod. Silver plated end-caps are expansion



BourNs LABORATORIES, INC.

General Offices: 6135 Magnolia Avenue Riverside, California
Plants: Riverside, California—Ames, Iowa

TRIMPOT • LINEAR MOTION POTENTIOMETERS • PRESSURE TRANSDUCERS AND ACCELEROMETERS

VISIT OUR BOOTHS #3716-18 I.R.E. SHOW

**Forethought
costs less than
Afterthought**

so . . .

Design These in When you Begin!

If you need mechanical or electrical counters in any of your new products, here's a word to the cost-wise designer: *Design them in, when you begin . . . don't tack them on later.*

For if you'll give us a chance to work with you, right from the beginning, chances are we can save you time and money by adapting or modifying a *standard* Veeder-Root Counter to your needs . . . where you might get into a costly special job if you went about it alone. What's more, you save time in your engineering, purchasing and assembly departments.

Count on Veeder-Root to help you in every way . . . from design to delivery. Write:



Series 1370 High Speed Counter (1500 to 2500 rpm) built into a wide variety of equipment.

*Everyone...
Can Count on*

Veeder-Root

INCORPORATED

Hartford, Conn. • Greenville, S. C. • Chicago
New York • Los Angeles • San Francisco • Montreal
Offices and Agents in Principal Cities

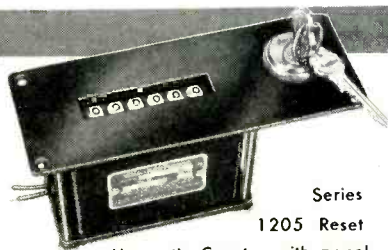

Series
1205 Reset
Magnetic Counter with panel
mount and lock and key.

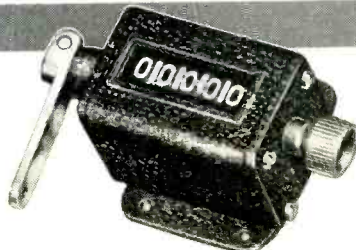

Series 1122 Small Reset Ratchet Counter.

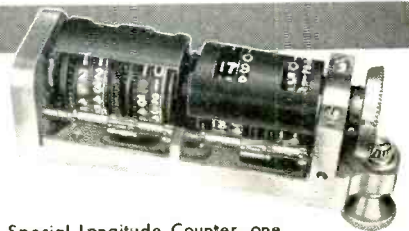

Special Longitude Counter, one
of many made for aircraft navigational
equipment.

Laminated Contact Materials

**INDUSTRIAL DIVISION
LEACH & GARNER CO.**

All industrial mill forms of precious and non ferrous contact materials — solid or laminated — custom made to exact specifications. All standard and many special alloys of gold, silver, platinum and palladium.

Precision products of precious metals include slip rings, micro brushes, contact rivets, buttons, spring contacts and bar contacts.

Complete engineering and tooling facilities for custom manufacturing. Prompt quotations and recommendations upon inquiry.

**INDUSTRIAL DIVISION
GENERAL FINDINGS
AND
SUPPLY COMPANY**

Electronic and Electrical Components

We build our business on prompt deliveries at competitive prices.
SALES OFFICES:
NEW YORK • ATTLEBORO, MASS. • CHICAGO • LOS ANGELES

NEW PRODUCTS

(continued)

fitted for positive contact and the unit is encased in a nonhydroscopic ceramic tube and hermetically sealed with high temperature solder for improved stability characteristics. They are fully insulated and suited for snap-in component clips.

The resistors conform to MIL-R-10509B specifications and are furnished in standard tolerance of ± 1 percent. Tolerances of ± 2 percent and ± 5 percent are available on special order. These resistors are furnished in $\frac{1}{4}$, $\frac{1}{2}$, one and two-w sizes and each unit is marked with resistance, tolerance and manufacturing information. Circle P61 inside back cover.



SERVO AMPLIFIER a transistorized device

M. TEN BOSCH, INC., Pleasantville, N. Y. Model 1800-0700 is a miniaturized, hermetically-sealed, plug-in transistor servo amplifier. It is primarily intended to receive signals from a synchro control transformer and to operate a size 15, 60-cycle, 6.1-w servo motor or equivalent. Input impedance is 10,000 ohms (nominal). Typical voltage gain is 550 at two-watts output. The amplifier is designed to meet the environmental requirements of specification MIL-E-5400. Circle P62 inside back cover.

PLASTIC LAMINATES used in printed circuits

GENERAL ELECTRIC Co., Coschocton, Ohio, has introduced a new, high-insulation resistant plastic laminate designed particularly for printed circuit applications. Textolite cold punch 11572 is a low-cost, paper-base laminate recommended for electronic applications using high voltage at radio fre-

Westinghouse **IGNITRON TUBES** still the industry standard.



Westinghouse invented the Ignitron tube and has maintained a record of improvements that are today the accepted industry standards:

- kovar seals to permit use of steel envelopes • improved ignitors to assure accurate ignition.
- thermostatic control for overload protection and water savings.

For highest quality Industrial and Special Purpose tubes—always specify Westinghouse.

YOU CAN BE SURE...IF IT'S Westinghouse

7ET-4103

ELECTRONICS — March 1, 1957

Want more information? Use post card on last page.

375

Why Do Ambitious Engineers Like General Mills?

Let's be realistic. The answer is real technical competence in the company you work for, and real opportunity for yourself!

Our people start with good salaries, share in liberal company benefits. It's not necessary that they move from company to company to improve their salaries or to find more challenging opportunities. We recognize ability, make promotions and salary adjustments accordingly. And with new projects being started almost weekly, promotions come rapidly.

But our people like General Mills for other reasons too:

FINANCIAL SECURITY . . . they know they work for one of the nation's largest and most diversified companies, paying dividends without reduction since 1929.

TUITION REIMBURSEMENT . . . many of them take advanced degrees at the University of Minnesota, under our tuition re-imbusement plan.

FRIENDLY ATMOSPHERE . . . they work with congenial people who share the same interests as they.

LOWER COST OF LIVING . . . their dollars buy more, they can save more—enjoy things not possible before.

DELIGHTFUL RESIDENCES . . . many of them live in "dream" homes in resort-like settings, only minutes from work.

TIME FOR FUN . . . they relax and enjoy themselves, because here there is time and opportunity for all kinds of activity in the land of 10,000 lakes.

We'd like you to investigate **your future** with General Mills. Talk it over with your wife. We think she'll like it here too. Minneapolis is a wonderful town in which to raise a family—while you do big things in the field you like best.

Join in the excitement at General Mills, where important things can happen to you, in any of these fields:

- MISSILES
- APPLIED MECHANICS
- GEOPHYSICS
- UNDERWATER
- ORDNANCE
- ELECTRONIC
- COUNTERMEASURES
- DIGITAL & ANALOG
- COMPUTERS
- INSTRUMENTS
- AND CONTROLS
- SOLID STATE PHYSICS
- MICROWAVES
- & ANTENNAS
- INFRARED SYSTEMS
- INERTIAL SYSTEMS
- SYSTEMS ANALYSIS
- & DESIGN
- SERVOMECHANISMS
- BALLOON SYSTEMS
- INDUSTRIAL
- AUTOMATION
- UPPER ATMOSPHERE
- RESEARCH
- FINE PARTICLE
- TECHNOLOGY
- SURFACE CHEMISTRY
- OPTICS
- MECHANICAL DESIGN
- AIRBORNE EARLY
- WARNING
- RADAR SYSTEMS
- INFORMATION
- THEORY
- ELECTRONIC EQUIP-
- MENT DESIGN and
- MINIATURIZATION

quencies. It is available with one or two-oz copper on one or both sides or in the unclad form.

The laminate can withstand exposure to common degreasing solvents used in printed circuit processes. Exposure to trichloroethylene vapors for 15 minutes produces no harmful effects.

The cold fabricating quality of Textolite 11572 eliminates dimensional changes resulting from the combination of heat and punching stresses. It punches cleanly at normal room temperatures, in thicknesses up to 1/8 in. Other significant features include high flexural strength, low power factor, high heat resistance and low moisture absorption. Circle P63 inside back cover.

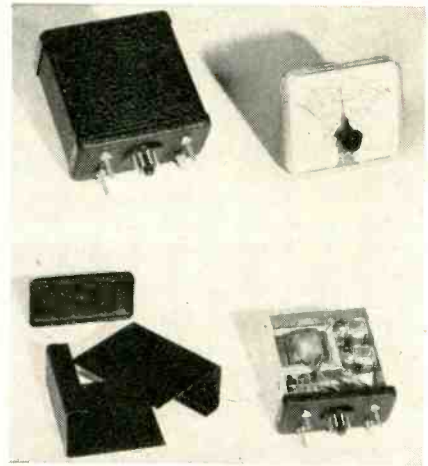

CONTROL PACK
miniaturized, plug-in unit

TIPP-TRONIC, INC., Tipp City, Ohio, has announced a miniaturized plug-in control pack, containing all the basic control circuitry needed for use with contact meter-relays. Because it is unitized, the control pack increases the flexibility with which meter-relays may be designed into original equipment. The pack measures approximately 4 by 2 by 4 in.

Standard minimum parts include an isolation transformer, a d-c power supply (including rectifiers) and slave relays to provide 5-ampere a-c, 115-v contacts. Frequently an interrupter or sampling circuit is also included.

The unit plugs into standard 11-pin octal type sockets. Four mounting studs provide additional

MECHANICAL DIVISION OF

General Mills

PETER D. BURGESS, Personnel Director—1
Mechanical Division General Mills
1620 Central Avenue Northeast
Minneapolis 13, Minnesota

Name

Address

City State

College Degree Year

We'd like to send you more information, in complete confidence. Complete the coupon for a quick reply.

**NO
CHANCE
FOR
ERROR**

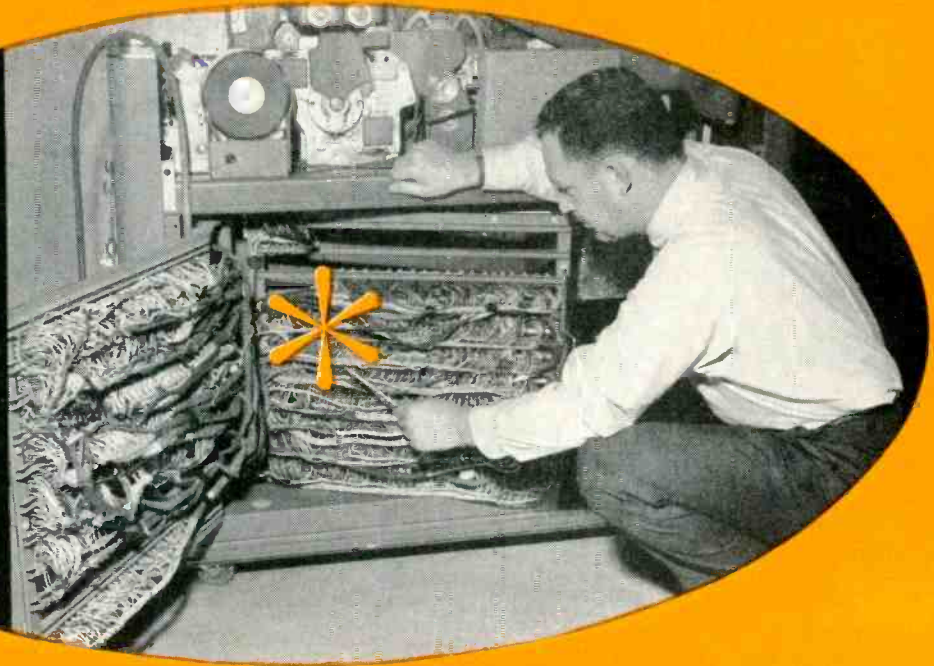

*** if conductors are branded with
Turbo identification markers!**

Positive Identification . . . is sure and easy when Turbo identification markers code your circuits, wiring, cable or connections. You're assured of an efficient low-cost operation wherever a multiplicity of electrical operations must be performed with speed and accuracy. They just slip on, yet fit so snugly they will not slide from position.

Permanent Identification . . . special links used in the manufacturing of Turbo Identification Markers provide permanent legibility resisting the effect of high and low temperature, abrasion, chemical action and humidity. Markers are manufactured from Turbo varnished cambric tubing and Turbo extruded plastic tubing and meet all applicable Army, Navy and Air Force specifications.

Merchandise your product . . . with Turbo Markers your trade mark or whatever imprint you want can be applied longitudinally or circumferentially in a variety of colors. Anything that can be drawn, in fact, can be printed. Use them to code component parts or to brand any wire, cable, tube, rod, pipe or hose.

Available . . . in all standard sizes from No. 14 to 1½" I.D. in lengths from ¾" to 4". Longer lengths or special non-standard sizes or colors furnished upon request. Write for samples.



Permanent identification — available in a wide range of sizes and colors

**WILLIAM BRAND
AND COMPANY, INCORPORATED**

WILLIMANTIC CONNECTICUT

QUALITY ELECTRICAL AND ELECTRONIC WIRE
AND TUBING SINCE 1925

Be sure to visit the William Brand Suite at the Plaza Hotel, New York, during the I.E.E. show March 18-20.

**THE
RIGHT
RELAY
IS...**



A HUSKY RELAY!

Specify Husky Relays. You know you're getting the quality that comes from precision engineering. Every Husky Relay is thoroughly tested and inspected to insure that it meets the highest standards of performance.

Many varieties of relays for all types of application are included in the complete Husky line. We invite your inquiry for engineering review and recommendations.

Rely on a Husky Relay—the right relay for every job!

**SEE US AT THE
I. R. E. SHOW
BOOTH 2407**

New York—March 18-21

Price Electric
CORPORATION
FREDERICK, MARYLAND

mechanical support. Circle P64 inside back cover.

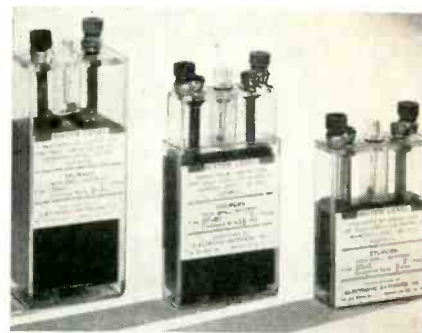

NONSPILL BATTERIES for portable power

ELECTRONIC BATTERIES, INC., 28-34 35th St., Brooklyn 32, N. Y. Sturges light-weight and ruggedly constructed nonspill storage batteries are assembled from two-volt cells in transparent plastic cases which afford visual inspection of the cells at all times. The bodies of the cases are entirely seamless and the tops or covers are cemented to the bodies forming homogeneous leak-proof nonspill units. The low internal resistance and completely free circulation of the electrolyte in the batteries assures an average output of 13½ watt hours per pound of battery. They have a cycle life of 100 cycles of charge and discharge varying with service conditions.

These batteries are now being used in the electronic, aviation, sound recording, television, research laboratory and radio communication fields. Literature is available. Circle P65 inside back cover.

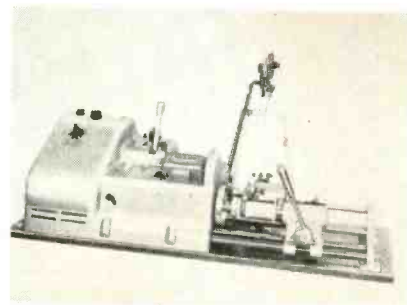

BOBBIN WINDER gearless, high speed unit

GEO. STEVENS MFG. Co., INC., Pulaski Road at Peterson, Chicago 30,

IBM GROWTH promoted these men

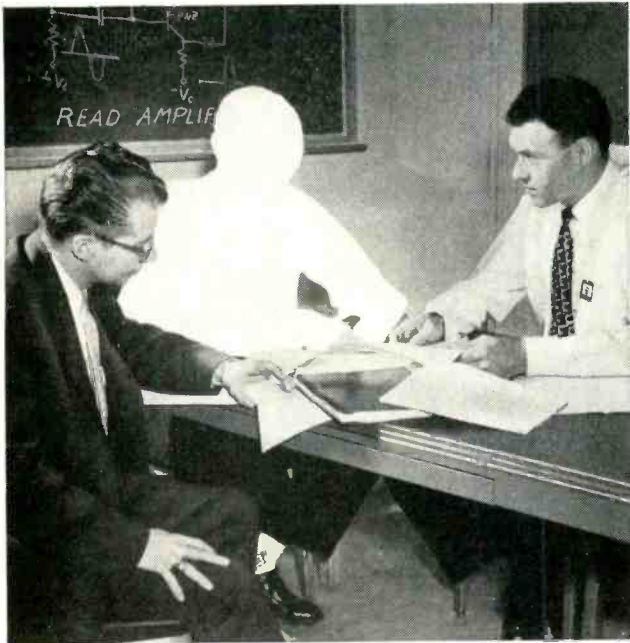

PRODUCT DEVELOPMENT ENGINEER: Before his recent promotion, this man was a member of a small engineering "team" (two M.E.'s, an E.E. and a model maker) in IBM's Poughkeepsie plant. His specific project entailed the creation of the "ultimate package in printed circuitry." His group "brainstormed" the project in continual sessions, putting the results in model form. Then the group would try to "tear the idea to shreds" in order to create something even better.

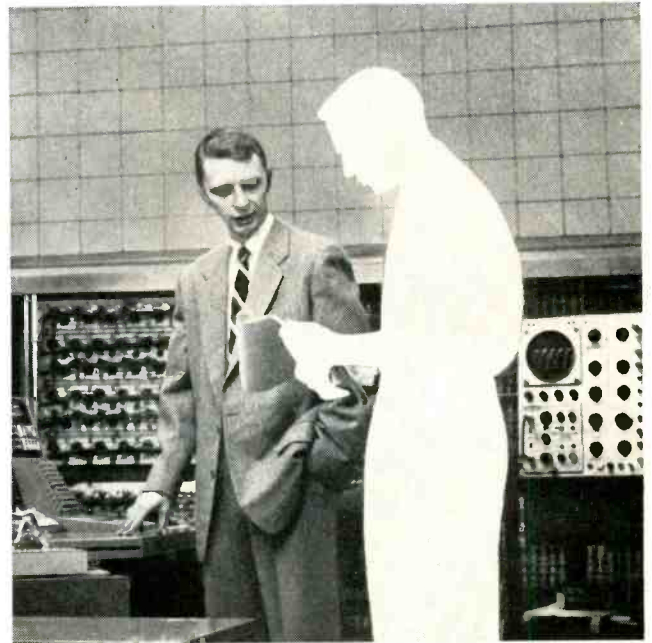

PRODUCT CONTROL ENGINEER: Promoted recently, this man formerly worked at IBM's Poughkeepsie manufacturing facilities. His job was to design information systems to insure a smooth flow of work through the plant. "It takes *creative* engineering ability to design these systems," he'll tell you, "and *administrative* ability to 'sell' a system to higher management and make it stick. If you possess this rare combination of abilities, this is the job for you!"

Could you handle their responsibilities?

Jobs like these continually open up at IBM—due to rapid expansion. If you are an engineer or scientist—or have equivalent experience—you may be qualified for such a position. Innumerable opportunities exist in:

- Computer systems planning
- Numerical analysis and programming
- Electronic circuit design and packaging
- Electrostatic phenomena
- Real time systems engineering
- Photo and magnetic device memory
- Semi-conductor research, development, and manufacturing
- Manufacturing process control
- Computer systems testing
- Test equipment design

Economic experts rank the electronic computer with automation and nucleonics in growth potential. More than 10,000 electronic computers will be in operation by 1966. IBM sales have doubled, on the average, every five years since 1930. IBM engineering laboratory personnel quintupled in the past five years. IBM spent \$19,000,000 on research and new product development in 1956. Salaries are excellent; company-paid benefits set standards for industry today. Personnel turnover at IBM is less than one-sixth the national average.

FOR THE FACTS about an engineering career with IBM, just write, outlining background and interests, to:

R. A. Whitehorne
Mgr. of Engineering Recruitment, Dept. 403
International Business Machines Corporation
590 Madison Avenue, New York 22, N. Y.

Where would you like to work for IBM?

IBM plants and laboratories are located in:

Endicott, Kingston, New York City, Owego, Poughkeepsie, N. Y.; San Jose, Calif.; Washington, D. C.; Greencastle, Ind.; Lexington, Ky.; Rochester, Minn.; Sherman, Texas. Branch offices in 189 cities throughout the U. S. A.



IBM INTERNATIONAL BUSINESS MACHINES CORPORATION

Be sure to visit the IBM booth at the I. R. E. Show, March 18 through 21.

DATA PROCESSING • ELECTRIC TYPEWRITERS • TIME EQUIPMENT • MILITARY PRODUCTS



rocket research . . . remote station connections . . . petroleum electronic cabling . . . computer manufacture

**41,000,000 feet
of VECTOR Cables
are now serving
the electronics industry!**

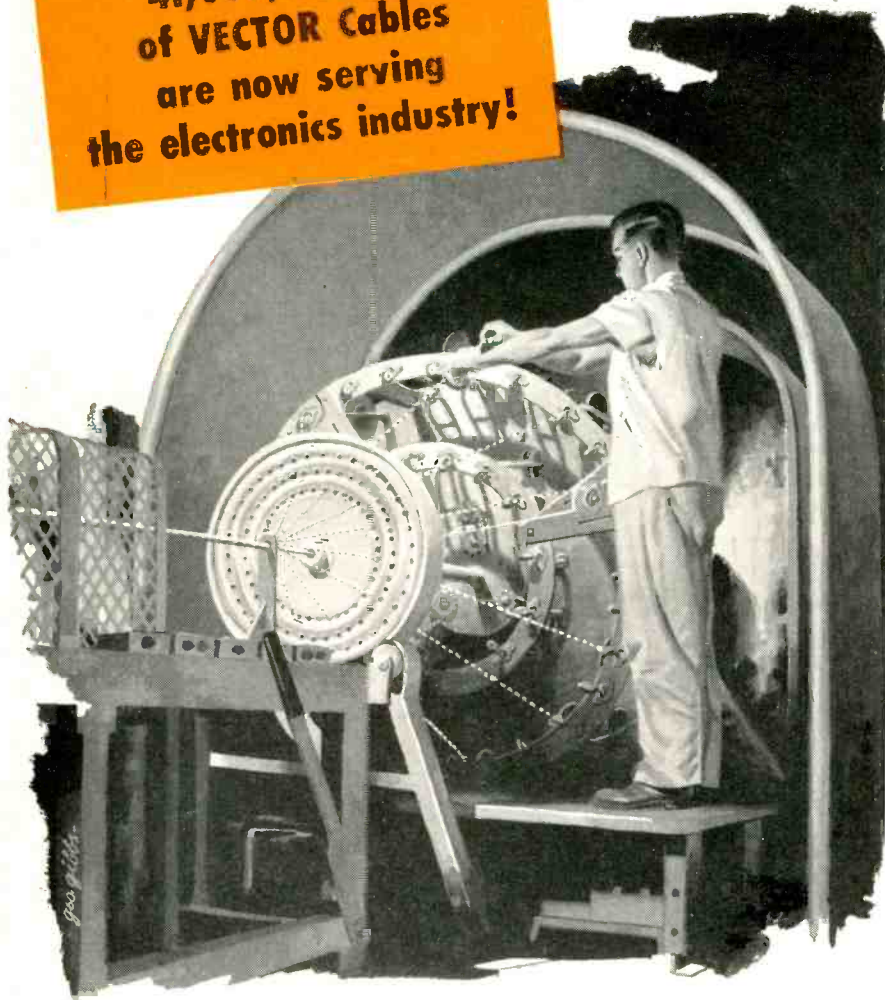

For more than 10 years, Vector has been manufacturing special-purpose multi-conductor cables for industrial applications. These custom products range from only a few feet in length to more than a mile, and have up to 130 concentrically laid conductors.

Sheathed in continuously extruded rubber or vinyl jackets, thousands of these cables are serving industry under the most severe conditions imaginable, from temperatures far below zero to the heat of tropical jungles. In many of these applications, the cables are required to withstand constant flexing and handling and even towing stresses.

Whether you're designing a complex rocket-firing fixture or connecting portable installations, just send Vector's Engineering Department an outline of your project. We'll work out your multi-conductor interconnection problems with a complete cable installation guaranteed to meet your requirements.

Vector **MANUFACTURING COMPANY**
5616 LAWDALE AVE. • HOUSTON 23, TEXAS

Western Representative: C. B. Rush and Associates
McKinley Building, 3757 Wilshire Blvd.
Los Angeles 5, California

Ill., has developed a new high-speed direct drive adjustable winding length bobbin winder which eliminates gear changing between jobs. Need for gears is entirely eliminated by a time-saving pitch selector which cuts job changeover time in half. An emergency safety stop button, conveniently located in front, stops the machine instantly.

Model 312-AM winds all types of random wound bobbin, repeater, relay and space wound coils, solenoids, resistors and distributed constant delay lines. Winding speed is up to 8,000 rpm; winding range, 60 to 700 turns per in.; wire sizes wound, 27 to 46; maximum o-d of coil wound, 2 in.; maximum traverse for any single continuous winding, 3½ in.; maximum loading area for multiple winding, 8½ in.; output end of spindle, ½-in. flatted shaft; and winding traverse infinitely adjustable between ¼-in. and 3½ in. Circle P66 inside back cover.

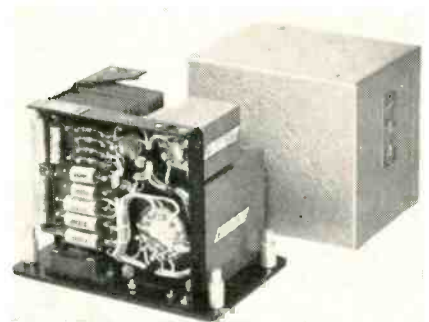

SERVO AMPLIFIERS for 60 and 400 cps motors

INDUSTRIAL CONTROL Co., Wyandanch, L. I., N. Y., presents a complete line of servo amplifiers for both 60 and 400-cps servo motors, ranging in shaft power from 1 to 50 w. These amplifiers have been designed with universal characteristics and flexible input circuits. Circuit techniques range from vacuum tube to transistor-magnetic and all the most widely used servo motors are covered.

Four packaging styles are offered, including hermetic sealing and plug-in, quick disconnect packages. The input networks are arranged in three groups, for

Facts
about

STABILINE[®] Automatic Voltage Regulators

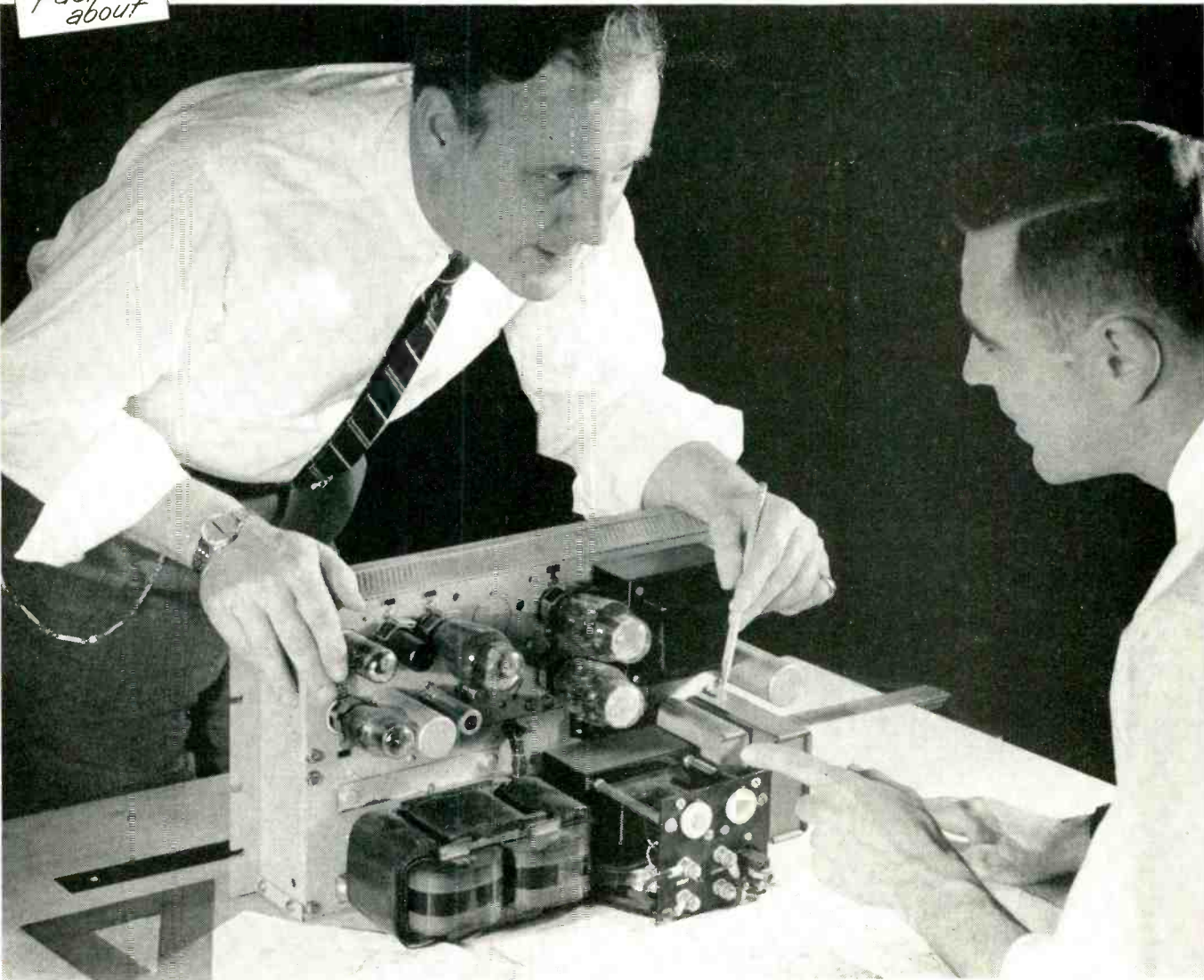

“Here’s how to Build-in Automatic Voltage Regulation”

“No matter how good your control instrumentation is, it is not going to be precisely accurate at all times unless the input voltage is precisely constant.

“You just can’t get better automatic voltage regulation equipment than with this STABILINE. At no load, full load or any intermediate stage it maintains constant *output* voltage regardless of line fluctuations.

“This sensitive, yet ruggedly constructed, automatic voltage regulator is a must component in today’s voltage sensitive apparatus.”

STABILINE type IE (Instantaneous Electronic) is available in 115 volt units — input range from 95-135v. and 230 volt units — input range from 195-255v. STABILINE type IE5101R shown above.

Three types of STABILINES are available for individual needs:

Type IE (Instantaneous Electronic) is completely electronic, instantaneous in action, with no moving parts. Constant output voltage is maintained regardless of line or load fluctuations.

Type EM (Electro Mechanical) has zero waveform distortion. Insensitive to magnitude and power factor of the load. Highly efficient.

Type TM (Tubeless Magnetic) has no moving parts . . . no tubes . . . no transistors. Ideal for unattended locations or where failure can never be tolerated.

Be sure to see
SUPERIOR ELECTRIC'S
Mobile Display
when it is in your area



THE SUPERIOR ELECTRIC COMPANY
203 BRADLEY AVENUE, BRISTOL, CONNECTICUT

Please send STABILINE Bulletin S657
Have your representative call

Name
Company
Address
City Zone State

Offices: Los Angeles, California • San Francisco, California • Toronto, Ontario, Canada • Miami, Florida • Chicago, Illinois • Baltimore, Maryland • Detroit, Michigan • New York, New York • Cleveland, Ohio • Dallas, Texas • Seattle, Washington

ELECTRO-MEASUREMENTS, INC.
1957 I. R. E. Show - N.Y.C. - Mar. 18-21

esi BOOTH 3010

D. C. STRAIN • M. L. MORGAN
L. R. ROCKWOOD • L. A. MORIN

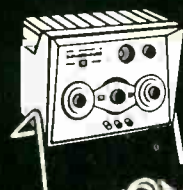
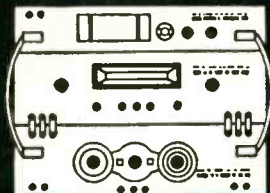
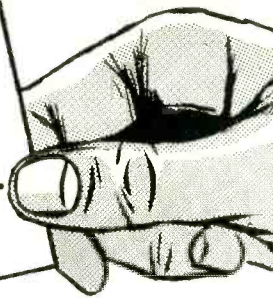

*We cordially
invite you to
visit us at the*
MARCH I. R. E. SHOW
and see our latest...
PRECISION INSTRUMENTS

- GENERAL PURPOSE IMPEDANCE BRIDGE AND AMPLIFIERS
- COMPARISON BRIDGES
- CAPACITANCE BRIDGES

AND COMPONENTS

esi

DEKAPOT® POTENTIOMETERS
DEKABOX® DECADE RESISTORS
DEKASTAT® DECADE RESISTORS
ESIPOT® POTENTIOMETERS

ELECTRO-MEASUREMENTS, INC.
7524 S. W. MACADAM • PORTLAND 1, ORE

NEW PRODUCTS

(continued)

single speed synchro and pot data, two speed synchro data and d-c data. Most amplifiers are completely self-contained operating directly from the power lines. All units are designed to meet applicable military specifications and industrial usage requirements. Circle P67 inside back cover.

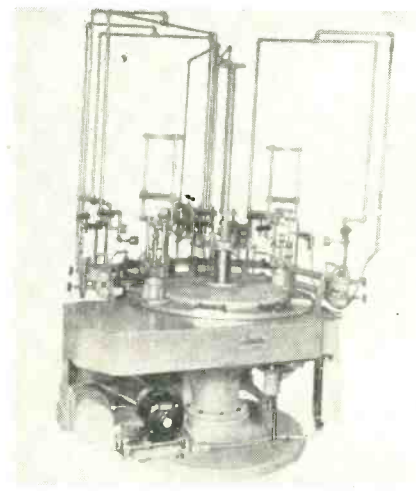

SEALING MACHINES
for difficult-shape tubes

KAHLE ENGINEERING Co., 1400 Seventh St., North Bergen, N. J., has created an improved group of sealing machines to accommodate elongated neck lengths, difficult envelope shapes, increased numbers of components and more exacting precision levels. Machine No. 2815 will accommodate tubes with neck lengths up to 40 in.

Product speeds of up to 140 units per hour are easily maintained. Customized Kahle equipment for any sealing need can be supplied with many optional features which include full automatic programming. Circle P68 inside back cover.

SEALED SWITCH
with potted wires

HAYDON SWITCH, INC., Waterbury, Conn., announces a new hermetically sealed potted switch complete with actuator. Primarily for use on aircraft and missile applications, it will operate under the most trying environmental extremes.

Special feature is the threaded actuator plunger guide sleeve

NEW

NEW ENGLAND TRANSFORMER

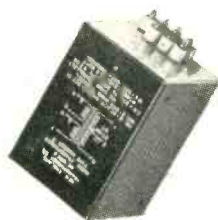

FAST SERVICE

**ELECTRONIC
TRANSFORMERS**

UP TO SIX
MADE TO YOUR SPECIFICATIONS

SHIPPED WITHIN ONE WEEK

Mr. H. F. S. Morris will be at the Hotel Dorset, 30 West 54th St.
during the I.R.E. show

NEW ENGLAND TRANSFORMER COMPANY
SOMERVILLE, MASS. • SOMerset 6-6100



No matter what factors govern your choice of precision components . . .

THE ANSWER IS HERE

The Fairchild line of precision components includes *forty-two standard types* of precision potentiometers, pressure transducers and accelerometers. Please note that this does not include any of the countless specials or design variations on basic units that we have made for various customers . . . or could make for you.

The 42 standard types embody *seventeen basic product categories* including wire wound or metal film, single- or multi-turn, linear and non-linear in both phenolic and metal cases; and high temperature types. Pressure transducers, accelerometers, trimmer potentiometers and linear motion potentiometers are also available.

In all these, Fairchild's continuing and extensive research now provides you with the optimum designs for size and functional conformity to best meet your individual needs. *Whatever* your potentiometer or transducer problem is, let Fairchild help you. Write for our new condensed catalog. Fairchild Controls Corporation, Components Division, Dept. 140-82A.

EAST COAST
225 Park Avenue
Hicksville, L. I., N. Y.

WEST COAST
6111 E. Washington Blvd.
Los Angeles, Calif.

FAIRCHILD
PRECISION POTENTIOMETERS
and COMPONENTS

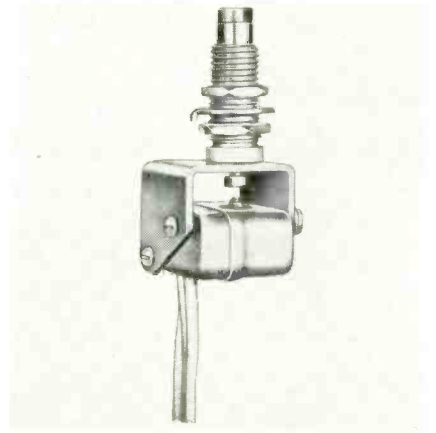

which permits mounting the switch actuator button flush or extended any distance from the mounting board up to $\frac{3}{8}$ in.

Switch No. 9129, mounted on actuator, has $\frac{1}{4}$ in. overtravel with $\frac{1}{8}$ in. pretravel along the plunger. Switches tested have passed the 50-g shock MIL specification.

Information on the 9129 and a copy of the new precision switch catalog are available. Circle P69 inside back cover.

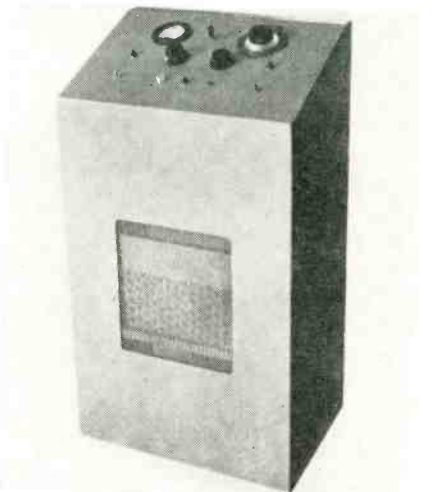

ULTRASONIC GENERATORS for industrial processing

GULTON INDUSTRIES, INC., 212 Durham Ave., Metuchen, N. J., has announced a new series of ultrasonic generators designed to drive a wide variety of low-impedance ultrasonic transducers. Accenting an untuned output system and featuring 500-w r-f power output plus a varied range of frequency levels, these generators will be found useful for performing numerous electromechanical techniques such as cleaning, chemical

silhouette against the sky...

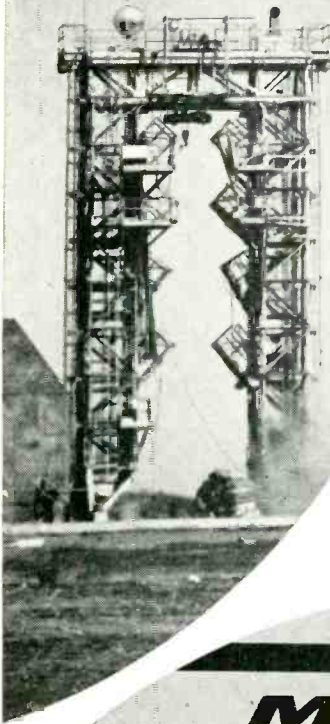

Towering above the American scene, the gantry is not an uncommon sight at rocket research sites. But that same shape silhouetted against the sky near Denver takes on added significance.

This is the home of the ICBM, Titan . . . and of the men entrusted with its development.

We need more men to assume that responsibility. This is a vitally important job and offers benefits commensurate with such a challenge.

Contact us about shaping *your* future.

Write to Emmett E. Hearn,
Employment Director, Dept. E-03,
P.O. Box 179, Denver 1, Colorado.

*See Mr. Montgomery at the Waldorf-Astoria
during the I. R. E. Convention.*

MARTIN

DENVER

for
**HEARING
AIDS**



or
**RECORDING
HEADS**



or ANY MAGNETIC MATERIALS JOB ...

Write for
your Copy
"MAGNETIC
MATERIALS"

This 32-page book contains valuable data on all Allegheny Ludlum magnetic materials, silicon steels and special electrical alloys. Illustrated in full color, includes essential information on properties, characteristics, applications, etc. Your copy gladly sent free.

ADDRESS DEPT. E-87

You can rely on core materials like the Allegheny 4750 components illustrated above, in your receivers, recording heads or microphone assemblies.

In fact, whether your equipment is small or large, the extra-broad line of A-L magnetic materials will solve your magnetic core problems. It includes all grades of silicon steel sheets or coil strip, as well as Allegheny Silectron (grain-oriented silicon steel), and a wide selection of high-permea-

bility alloys such as 4750, Mumetal, Permendur, etc.

Our service on these materials also includes complete facilities for the fabrication and heat treatment of laminations. (For users of electrical sheets and strip, our lamination know-how is a real bonus value!) Either way, we'll welcome the chance to serve you. Allegheny Ludlum Steel Corporation, Oliver Building, Pittsburgh 22, Pa.

STEELMAKERS to the Electrical Industry
Allegheny Ludlum



W&O 5335

processing, soldering and drilling.

The series of generators, designated Glennite U-405, are blower cooled and operate at a nominal fixed frequency of 40 kc or at any frequency between 20 kc and 2 mc, depending on model. Circle P70 inside back cover.



PREAMPLIFIER

for impedance matching

MADISON FIELDING CORP., 863 Madison St., Brooklyn, N. Y., announces the Micamp, an all-transistorized, impedance-matching preamplifier which permits the direct use of low-impedance, low-gain cartridges and microphones with high-impedance tape recorders, amplifiers, p-a systems and the like. Providing more than 30 db gain, with no hum pickup and no distortion at normal levels, it insures a frequency response of within 1.5 db from 20 to 20,000 cps.

Input impedance is from 50 to 250 ohms; output impedance, 18,000 ohms. Signal-to-noise ratio is better than 50 db. Circle P71 inside back cover.

MULTICHANNEL SYSTEM

for temperature measurement

ARNOUX CORP., 11924 W. Washington Blvd., Los Angeles 66, Calif. A miniature multichannel airborne temperature measurement system gives full scale output of five v. Models are offered in seven, 14 and 20-channel capacity. Power requirements are 115 v, 400 cps. Total power consumption of the 20-channel model is less than 20 w. The TME contains two precision mag-amp type regulated d-c power supplies, series connected with common neutral, for excitation of

*Reliability
Comparisons
Invited*

Shallcross

PRECISION WIREWOUND RESISTORS

This is your invitation to test and compare Shallcross precision resistors for that elusive quality known as reliability.

Statisticians tell us that component reliability and, subsequently, equipment reliability, can be predicted on a sound mathematical basis—assuming that environment is correctly predicted.

Unfortunately, most equipment manufacturers have divergent ideas of what component environments should be. Thus there are just as many interpretations of what constitutes a reliable component. In the absence of a common gage for reliability, Shallcross welcomes the opportunity of working with the standards and components groups now being established by many equipment manufacturers.

To save valuable testing time, Shallcross can supply qualified recipients with complete test data that shows to what extent MIL-R-93A is met or exceeded for any of eleven resistor styles. Data is also available on four of twelve Shallcross styles conforming to the 125°C MIL-R-9444 Specification. Data on remaining styles will be available as soon as testing is completed.

Details on Shallcross resistors designed to MIL Specifications as well as helpful application notes on encapsulated precision wirewound resistors are contained in newly-released Supplement to Bulletin L-30. For your copy write: SHALLCROSS MANUFACTURING CO., 522 Pusey Ave., Collingdale, Pennsylvania.

MIL-R-93A RESISTORS

... for 85°C
ambients

MIL-R-9444 RESISTORS

... for 125°C
ambients

See Us at the
IRE SHOW

... Booth 2634

FOR THE THIRD CONSECUTIVE YEAR

ENGINEERS RATE LAMBDA FIRST

in all Power Supply Surveys

Every independent study of power supply preferences has shown an overwhelming vote for Lambda. In the most recent survey, made by a leading electronics publication, engineers who specify power supplies choose Lambda by more than 2½ times over the next identified manufacturer. This is the greatest margin of preference yet. Here is additional proof that the more opportunities users of power supplies have to try Lambda equipment for themselves, the more they recognize the superiority of these outstanding units.

We suggest that you inspect Lambda power supplies in use in your own area. We will be happy to provide names of nearby users. Ask the candid opinion of the men who work with this precision-engineered equipment daily.

"See the new Lambda Com-Pak series at the IRE Show. New, space saving, 200 MA, 400 MA, 800 MA and 1.45 amp models. Be sure to stop by Booths 2436-2438."



QUALITY CONTROL assures you of long, dependable service from these assembly-line-produced power supplies.



HERMETIC SEALING PROCESS provides for complete quality control. Lambda makes all its own transformers.

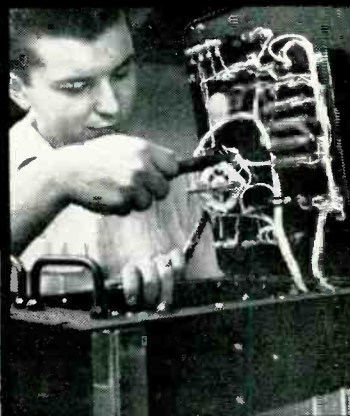

MECHANICAL INSPECTION at every relevant point means trouble-free operation for you.



ELECTRONIC INSPECTION is designed to provide consistent quality and eliminate in-service downtime.

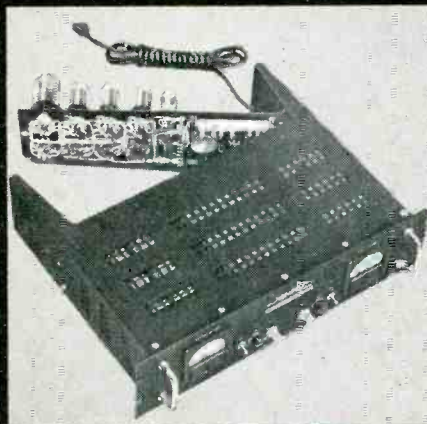

TYPICAL NEW LAMBDA "COM-PAK" MODEL (200-400-800 MA units) occupies a minimum amount of space, delivers maximum performance, is easy to service and maintain.

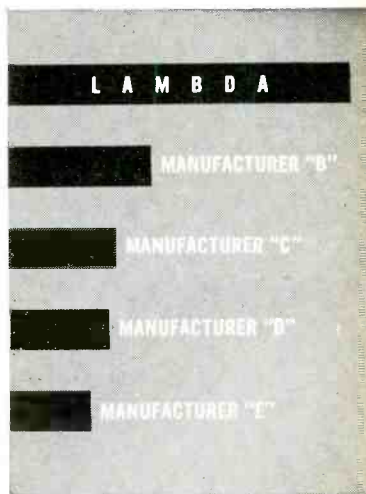

LAMBDA ELECTRONICS CORP.

The first name in power supplies

11-11 131 STREET • COLLEGE POINT 56, NEW YORK



SEND FOR NEW CATALOG 57

Just off the presses. Illustrations and specifications for the complete line of Lambda Regulated D.C. Power Supplies.

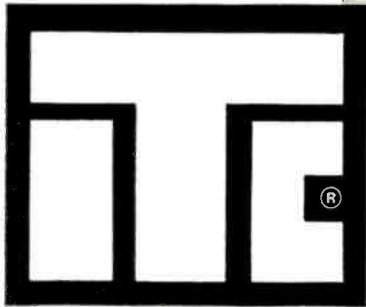

- Threshold voltage adjustment
- Fixed gain adjustments
- Critical magnetic and electric bias
- Balancing adjustments
- Padding
- Adjusting scale factors
- Parameter compensation
- Fixed reference circuits

THERE'S A TIC TRIMMER POT for every application

TIC manufactures in production quantities the most complete line of precision trimmer potentiometers in the industry. Common to all TIC trimmers is the unexcelled TIC quality construction and advanced design. The wide selection of sizes and shapes, in addition to the wide range of power and temperature capabilities, permit selection of units of maximum compatibility with a specific application.

The TIC Trimmer Potentiometer Line includes units from ½ inch to 1 inch in size . . . 50 to 100K ohms in resistance . . . -55° C to +145° C temperature range . . . power ratings up to 4 watts. Advanced mechanical design provides extremely precise, stable adjustments under all forms of adverse environmental conditions.

TIC was the originator of the high stability subminiature trimmer pots. For example the original metal-film potentiometer, the TIC RFT Metfilm, represents the outstanding advance high stability trimmer potentiometer design. The RFT contains a resistance element of metallic film that provides infinite resolution for ultra-fine trimming. Compactness of the RFT permits stacking 7 to the square inch. Latest addition to the TIC Trimmer Line is the new low cost RWT which, like the RFT, provides adjustment by use of a 25-turn lead screw.

Complete information on the TIC Trimmer Potentiometer Line is available upon request.

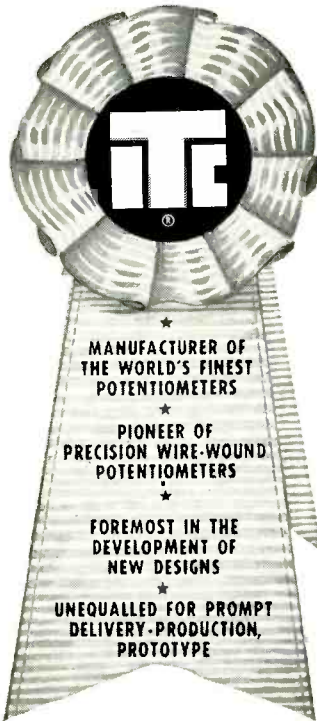

the temperature transducers in half bridge circuitry. Balance and attenuation controls are provided for each channel. Output voltage and impedance characteristics are directly compatible with f-m sub-carrier and pwm coder input requirements. System stability is within one percent throughout MIL-E5272A environments. Dimensions of 20-channel model are 7 by 4½ by 3 in. Total weight is 5½ lb. Circle P72 inside back cover.

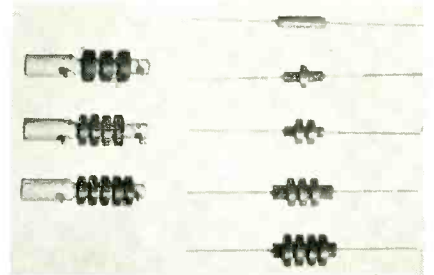

R-F CHOKES have high Q in small size

WATERS MFG., INC., P. O. Box 368, South Sudbury, Mass. Individually checked, and providing high Q in small size, a new line of r-f chokes has been developed. Five series are available to provide wide choice of characteristics. These series include solenoids on phenolic and powdered-iron forms and pie-wound coils on Ferrite cores, phenolic forms and powdered-iron forms, all with pigtail leads.

Pie-wound coils on ceramic forms have soldering terminals secured to the form. All units have finish conforming to MIL-V-173A; special finishes can be supplied. Inductance ratings are from 1.1 μh and up. Current ratings are from 50 ma to 2,800 ma.

A data sheet giving details of

TECHNOLOGY INSTRUMENT CORP.

569 Main Street, Acton, Mass., Colonial 3-7711.
West Coast Mail Address, Box 3941, No. Hollywood, Calif., POplar 5-8620

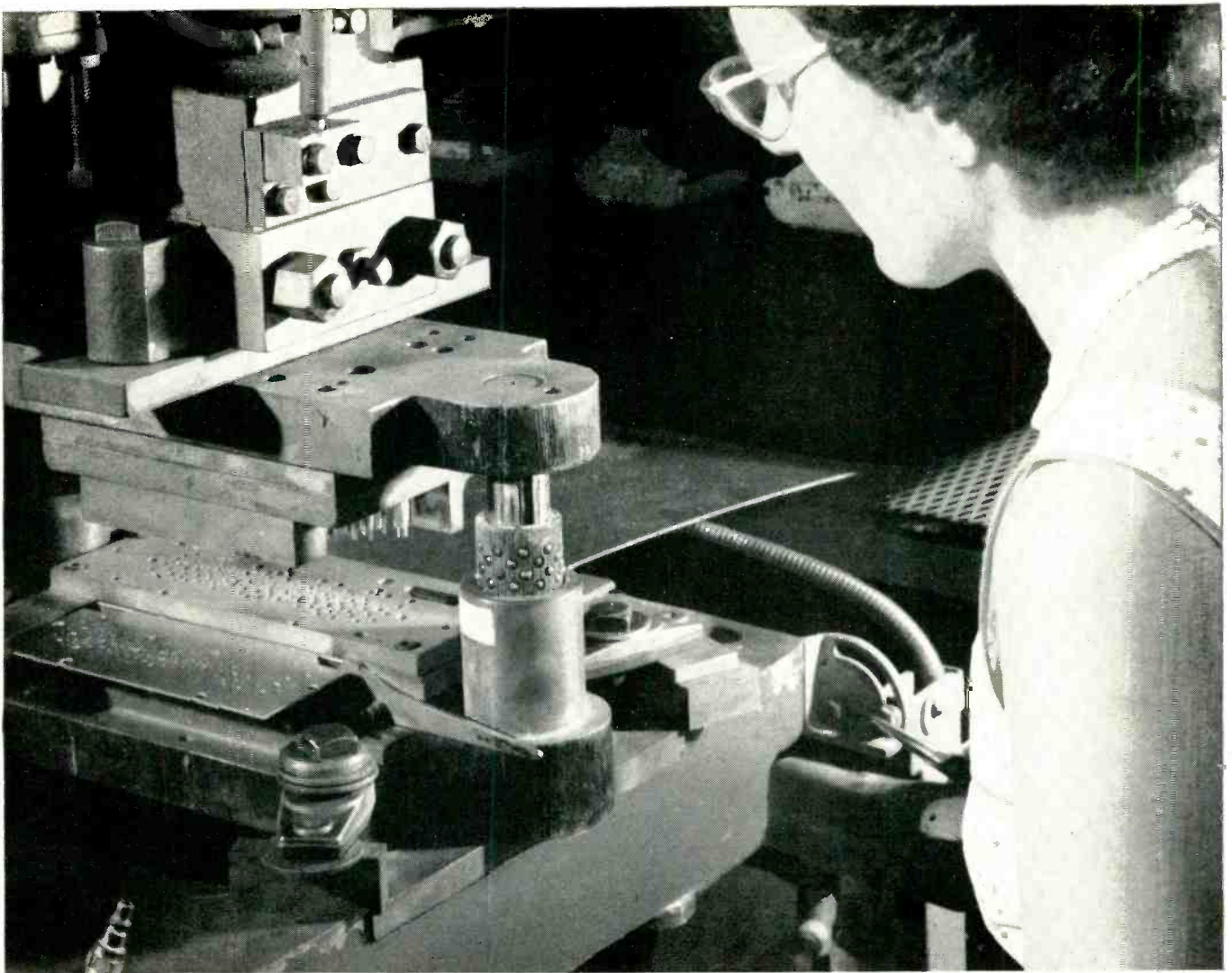

New copper-clad **MICARTA**[®] is easy to cold punch — no cracking, no chipping!

All holes in new H-3032 copper-clad MICARTA can be cold punched right on the assembly line in one operation, and there's no cracking, breaking or chipping. That is one of the reasons why this new laminate cuts costs and production time of printed circuits.

In addition, copper-clad MICARTA speeds up soldering, without the normal accompaniment of an increase in rejects and missed connections.

High bond strength — from 10 to 13 pounds versus an industry standard of six pounds — is retained even after heating and cooling are repeated many times, due to a new adhesive process.

If you have a circuit assembly problem, copper-clad MICARTA may be the answer. For further information and for technical data, write to Westinghouse Electric Corporation, MICARTA Division, Hampton, South Carolina.

J-06626

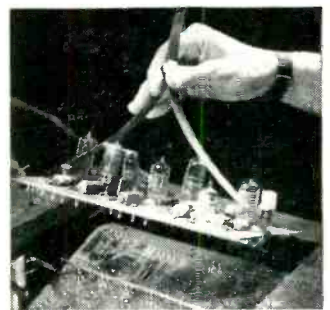

CAN BE DIP SOLDERED!
MICARTA will not blister — even when dip soldered for 10 seconds at 500° F. A special adhesive actually increases adhesive strength during soldering.

YOU CAN BE SURE...IF IT'S Westinghouse

the solution to your SPRING PROBLEMS is in our Files

Our files are literally bulging with the solutions to tough spring problems. Chances are, the exact solution to your particular problem is among them. If it isn't, you can be sure our experienced Spring Engineers will arrive at it in short order. Over the years they've turned their hand to the solution of some classic toughies. And over the years, Lewis' facilities, experience and reputation have combined to provide you with a dependable source for the exact spring for the job at the lowest possible cost.

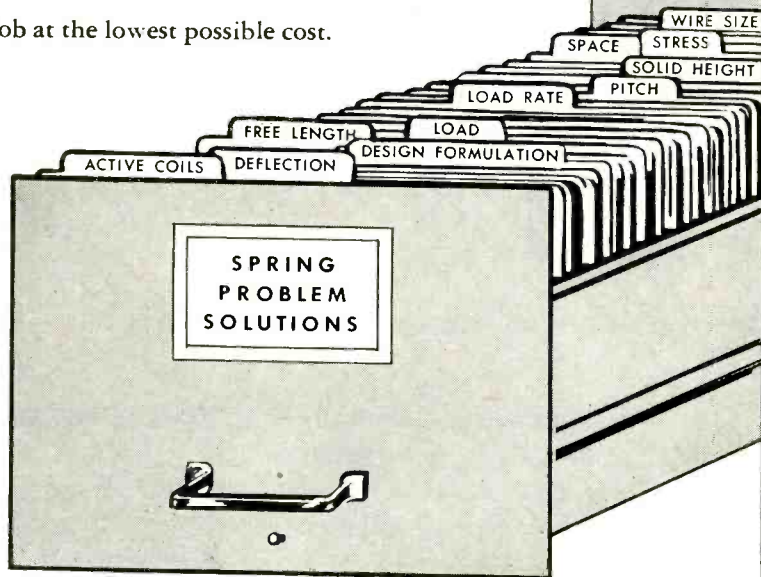

Looking for the solution to a spring problem? Send us drawings, specifications or samples today. No obligation, of course.

LEWIS SPRING & MANUFACTURING CO.
2656 W. NORTH AVE. CHICAGO 47, ILL.

Lewis  **PRECISION
SPRINGS**

The Finest Light Springs and Wireforms of Every Type and Material

NEW PRODUCTS

(continued)

inductance, resistance, Q-vs-frequency, current rating, self-resonant frequency, distributed capacitance and core sizes for all units is available. Circle P73 inside back cover.

MAGNETIC SHIELD for color tv tubes

MAGNETIC SHIELD DIVISION, Perfection Mica Co., Chicago, Ill. A new Fernetec Co-Netic leakproof magnetic shield for color tv tubes that weighs six lb, is produced by rotary extrusion methods and will reduce manufacturers' cost of the color sets, is now available. The Fernetec steel, $\frac{1}{8}$ in. thick, and the Co-Netic steel, 0.020 in. thick, have a coating which prevents the metal from setting up a north-south pole which automatically affects the color purity of one or three-gun tubes. Miniaturization of the chassis is possible because of the shield. Transformers can be put immediately adjacent to each other, with only a shield separating them, disregarding the point of how they are oriented. Components can be mounted on the shield because the shield does not become retentive and will support circulating currents. Circle P74 inside back cover.

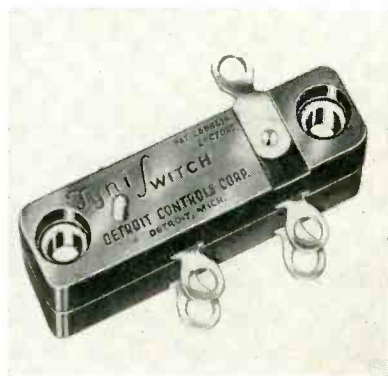

STACKED SWITCHES a space-saving system

DETROIT CONTROLS CORP., 800 Union Ave., Bridgeport, Conn. A new system of precision stacking of Class 1 TyniSwitches makes it possible to obtain a single actuator switch capable of switching two or more completely independent circuits. Each individual

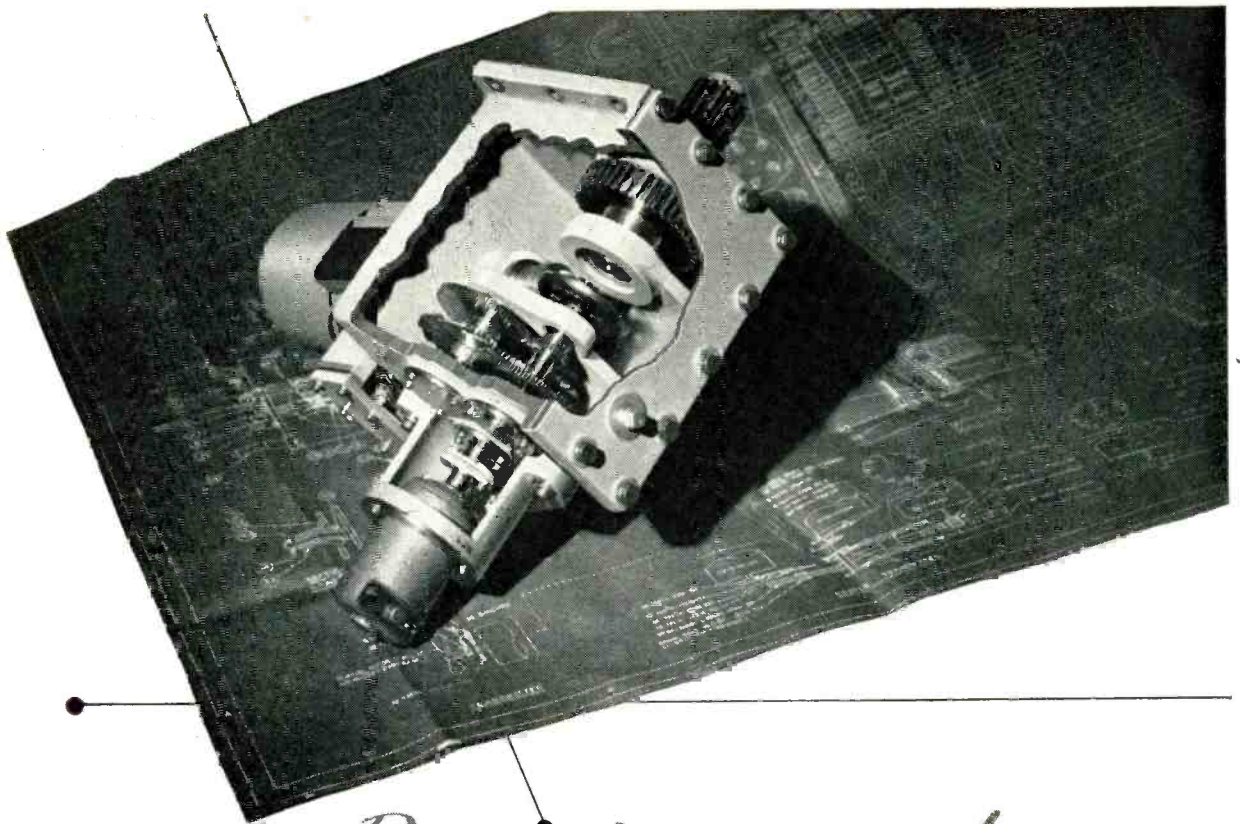

Precision-eered

ELECTRO-MECHANICAL ASSEMBLIES

FROM PILOT STAGE TO PRODUCTION EFFICIENCY

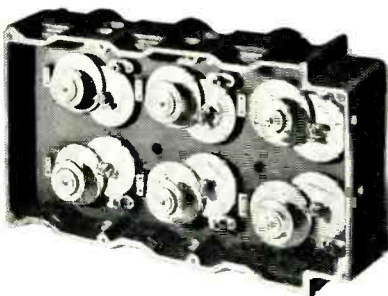
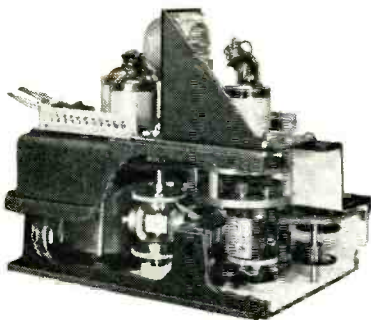

HAVE you a new product on the design boards? Do you have a new contract for radar, missiles, computers or other electro-mechanical devices? Then let Atlas help you from pilot stage to production efficiency.

Atlas experienced production and methods engineers layout the job using new cost-cutting methods, and improved processing techniques. Atlas toolmakers build dies and fixtures to implement these plans. Atlas skilled mechanics and assemblers produce prototypes to your exact specifications *on a job basis*, and can follow thru with production. As many men, machines and hours of work as your electro-mechanical unit requires and no more.

Atlas furnishes the practical engineering step between idea and production line. We've been "precision-eering" on a contract basis for more than a quarter of a century. May we work with you? Write for booklet "Precision-eering Electro Mechanical Equipment." ATLAS Precision Products Co., Philadelphia 24, Pa. (Division of Prudential Industries).

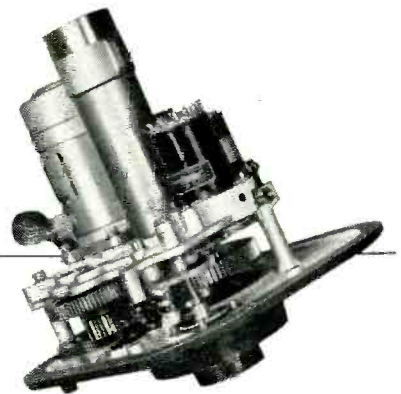

"From Drawing Board... to Production Line"

ATLAS

Precision Products



from design through
production...

ELECTRONIC CONTROLS

FOR AIRCRAFT AND MISSILES

Today some of the toughest electronic problems are being solved by Thompson's task force of engineers. For example: Thompson has designed and is manufacturing control subsystems and components for aircraft and missiles. Thompson also is a leader in development and production of countermeasures equipment and microwave components.

MISSILE CONTROLS
auxiliary power
supply controls

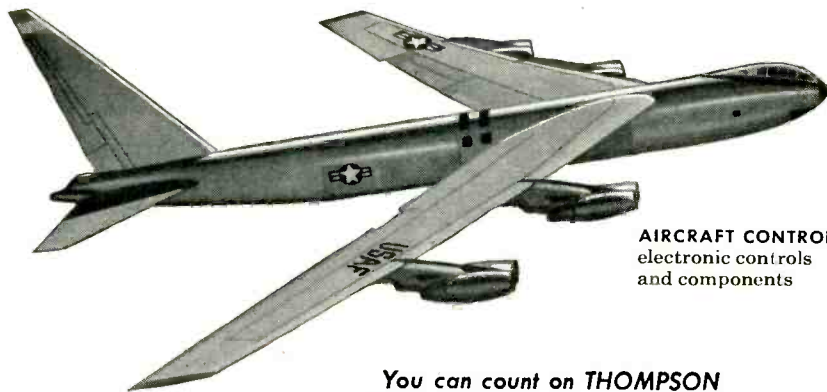
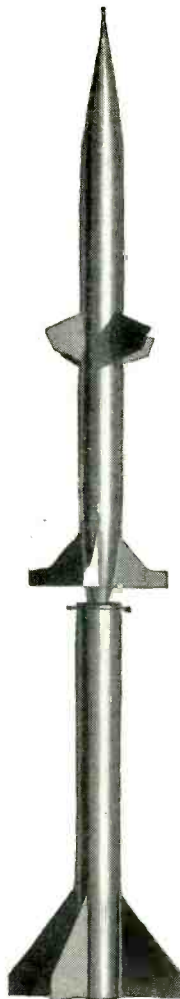

AIRCRAFT CONTROLS
electronic controls
and components

You can count on THOMPSON
Thompson experience, skills and facilities—from design through production—are ready to go to work for you. We're anxious to demonstrate that "you can count on Thompson" in the field of electronics.



ELECTRONICS DIVISION
Thompson Products, Inc.

2196 CLARKWOOD ROAD • CLEVELAND 3, OHIO
Career opportunities available for qualified engineers

Visit our Booth Nos. 2527, 2529, 2531 at the I.R.E. Show

NEW PRODUCTS

(continued)

switch action can be double throw, single throw normally open or single throw normally closed.

In multipole stacked Tyni-Switches maximum pin movement from the first contact actuation of all contacts is 0.015 in. Double-pole switches are considered as standard and are available with any standard Class I actuator. Switches with three or more poles will be built to customer specifications. Detailed information and descriptive literature are available. Circle P75 inside back cover.



QUARTZ CRYSTAL UNIT
sealed-in-glass

BLILEY ELECTRIC Co., Union Station Building, Erie, Pa. The BG9A-S, a 1,000 kc sealed-in-glass quartz crystal unit, is designed to provide exceptional stability with minimum ageing in secondary frequency standards.

Tolerance is ± 5 ppm at 70 C. Temperature coefficient is less than 0.4 ppm per deg C between +65 C and +75 C. The unit is 3 $\frac{1}{8}$ in. overall, T-9 bulb and standard octal base.

For complete design specifications request bulletin No. 491. Circle P76 inside back cover.

LIGHT COMPENSATOR
for tv cameras

BLONDER - TONGUE LABORATORIES, INC., 526 North Ave., Westfield, N. J., has announced an automatic light compensator that electronically compensates for variations in video signal level caused by variations in illumination, thereby eliminating the need for manual or remote resetting of the tv camera lens iris or control gen-

TAYLOR

Laminated Plastics
Vulcanized Fibre

Shop Talk

TAYLOR FIBRE CO.
Plants in Norristown, Pa. and La Verne, Calif.

PHENOLIC—MELAMINE—SILICONE—EPOXY LAMINATES • COMBINATION LAMINATES • COPPER-CLAD LAMINATES • VULCANIZED FIBRE

Tips for designers

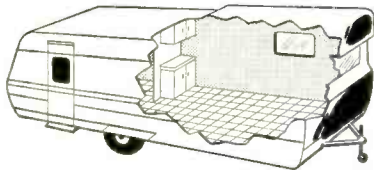

House trailer interior walls are made of plywood faced with Taylor vulcanized fibre, chosen for its combination of light weight and high strength.



Highway signs use Taylor Grade XX phenolic tubing and washers that are long-wearing and do not rust.

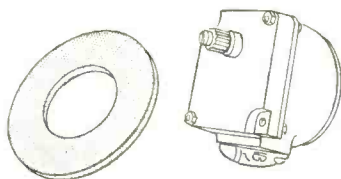

Self-balancing servo motor has stator case insulator which is cold-punched from $\frac{1}{4}$ " thick Taylor Paper Base Phenolic Laminate sheet.

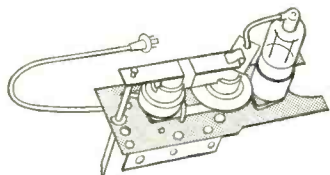

Base plate for high-voltage TV component, punched from Taylor canvas melamine laminate, has high dielectric strength and arc resistance.

NEW TAYLOR COPPER-CLAD LAMINATES

Taylor GEC (glass epoxy) Copper-Clad and Taylor XXXP-242 cold punching (paper-phenolic) Copper-Clad. Taylor uses high purity rolled copper on base materials with outstanding electrical properties.

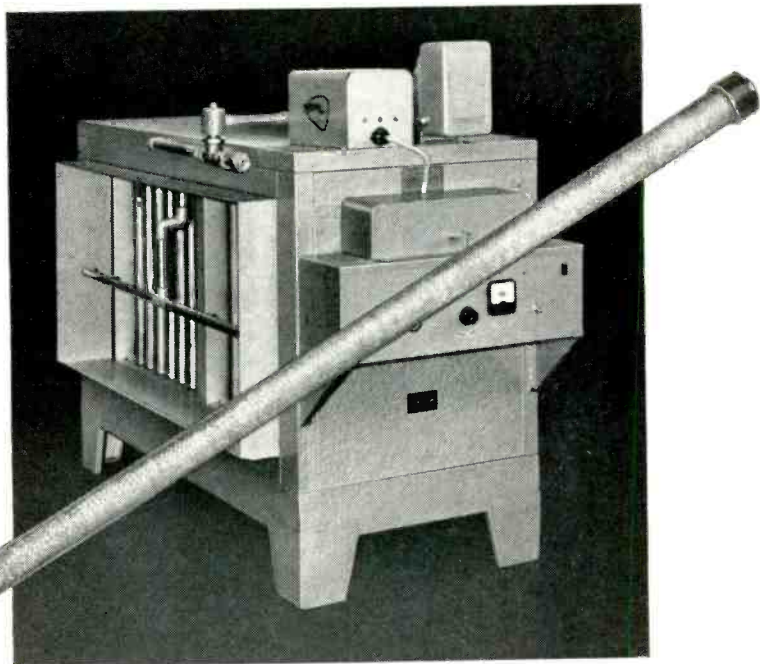

A selenium "pencil" rectifier made by Union Switch & Signal for an electronic air cleaner, by Electro-Air Cleaner Co., uses an outer tube of Taylor Grade G-5 laminated plastic. The material has excellent arc-resistance, mechanical properties and low moisture absorption.

Taylor Melamine Laminate solves material selection problems

The pencil-thin outer case of this selenium rectifier presented several unique problems. It required a new concept of high arc-resistance, plus mechanical strength and low water absorption. Taylor Grade G-5 (glass-melamine) laminate solved these problems . . . embodied both the electrical and mechanical properties required for the outer tube. The broad selection of Taylor laminates includes a wide variety of different bases and different grades, each with certain combinations of electrical and physical properties to answer your materials selection problems.

In any application, Taylor laminates bring you important savings in fabrication. Whether you need tubes, rods, sheets or fabricated parts, Taylor laminates come in sheets 49" by 49" . . . tubes with inside diameters as small as $\frac{3}{32}$ " up to 36", lengths to 49" and a variety of wall thicknesses . . . rods in a wide range of sizes. Or, Taylor can fabricate your part to your specifications . . . on time and at a saving.

To help you choose and use the right laminate, Taylor's engineering staff and fabricating facilities are at your service. Contact your nearest Taylor sales engineer.

What's YOUR Timing Device Requirement ?

HAYDON* has the RIGHT answer



A TYPICAL EXAMPLE

Series 7010
Elapsed
Time
Indicator

THE RIGHT MOTOR . . . unusually compact, fully enclosed mechanism, controlled lubrication, simple, accurate and dependable, operates in any position.

THE RIGHT DESIGN . . . for any application because you can select from the full line of HAYDON STANDARD interval timers, time delay relays, cycle timers, and elapsed time indicators.

THE RIGHT FACILITIES . . . because HAYDON has the fully integrated engineering and manufacturing facilities to produce and deliver quality on time . . . economically . . . in large or small lots.

THE RIGHT SALES SERVICE . . . because the HAYDON Field Engineer in your area is a Timing Specialist fully qualified to counsel you. He's listed in your Yellow Pages. Have him come in to discuss your requirements . . . or, if you prefer, write to us direct.

*Trademark Reg. U.S. Patent Office

HAYDON
AT TORRINGTON

A Subsidiary of General Time Corp.

HEADQUARTERS FOR
TIMING

HAYDON Manufacturing Company, Inc.
2427 ELM STREET, TORRINGTON, CONN.



erator. The ALC can automatically compensate for light variations as great as 150 to one. It is connected between the camera and its control generator. The cable from the camera plugs into the ALC input. A second short cable connects the ALC output to the control generator.

It has four controls: output level, video/target ratio, video age, and power-off. Complete specifications and further information are available from the company. Circle P77 inside back cover.

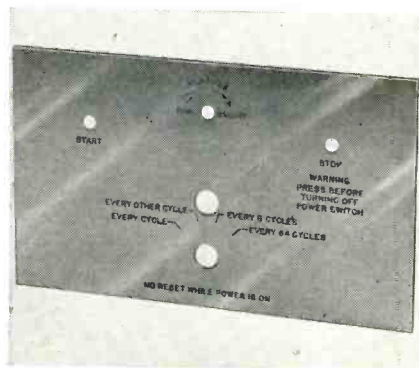

ENGRAVING STOCK for instrument panels

HERMES PLASTICS, INC., 13-19 University Pl., New York 3, N. Y., has announced Gravalum, a metallic engraving stock ideally suited for panels on instrument housings where shielding or grounding effect is required. It is a laminated material with an ebony black phenolic center core bonded between two exterior layers of satin finish aluminum. Engraving through the top layer exposes contrasting black lettering. This eliminates the need of filling in the engraving with paint.

Gravalum is available in sheets, strips or cut nameplates in thicknesses of $\frac{1}{16}$ and $\frac{1}{8}$ in. Samples

General Plate

ROLLED FORM STOCK

- **Cuts Production Costs**
- **Reduces Scrap Losses**
- **Minimizes Stock Inventories**

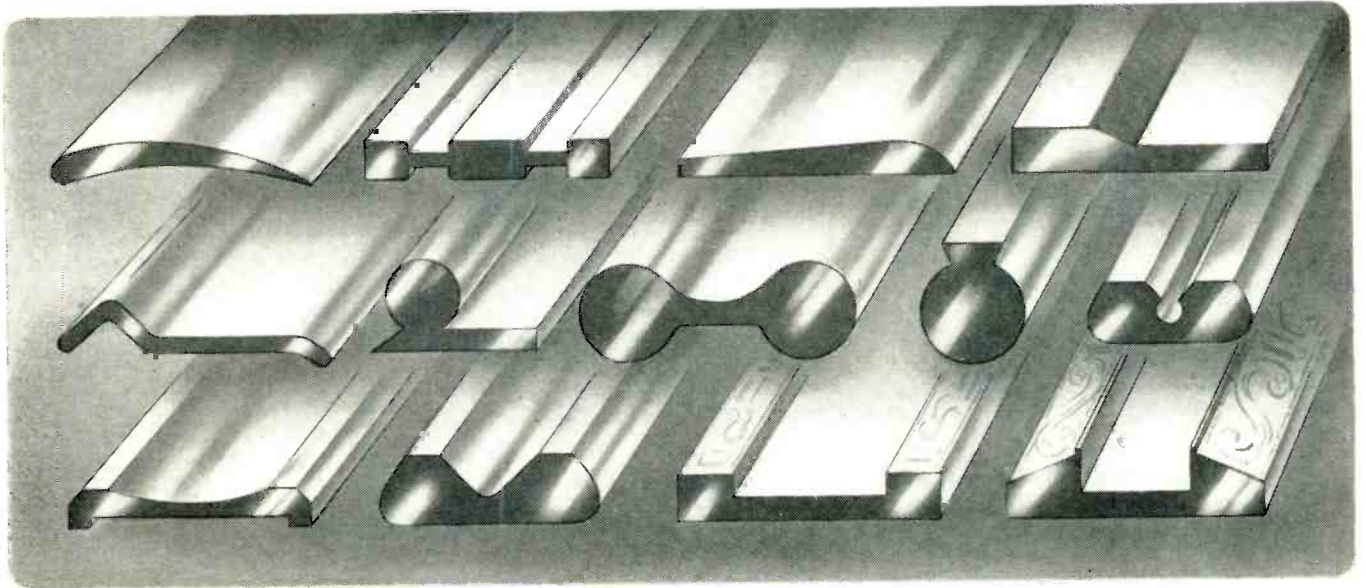

**You can profit by using
General Plate Rolled Form Stock.**

Metals & Controls Corporation

GENERAL PLATE DIVISION

1303 FOREST STREET, ATTLEBORO, MASS.

General Plate craftsmanship can mean substantial production and assembly savings to you, and at the same time minimize your rolled stock inventory problems. Here are some of the advantages available to you in General Plate rolled form stock:

1. Close tolerances in dimensions, contour, and composition.
2. Wide diversification of available metals and shapes.
3. Excellent surface finishes.
4. Heat treating facilities available.
5. Size range from .025" to 3½" wide.

These advantages, plus expert toolmaking — skilled production people — efficient delivery service — all resulting from years of experience in producing rolled form material — make General Plate a dependable source of supply for your formed stock needs.

We'd like to figure on your rolled form stock requirements — if you'll send information to help us quote, we'll be glad to estimate tool and material costs without obligation. The information we need is: (1) cross-sectional sketch or drawing and dimensional tolerances, (2) length of strip and tolerances, (3) material specifications, (4) permissible edge curvature and flatness, (5) surface finish required, (6) hardness, and (7) quantities involved.

Build into your transmitter



this handful of assurance

MicroMatch Directional Couplers* measure RF Power and VSWR—giving you, the designer, positive confirmation of your transmitter's performance and providing your customer with a monitor that constantly watches his transmission line and antenna.

Built into major military communications and ballistic missile programs, these compact, rugged—and low cost—couplers produce an output essentially independent of frequency over the range of 3 to 4000 megacycles. They are adjusted for full scale meter deflection at power levels of 1.2 watts to 120 KW. Accuracy of power measurement is plus or minus 5% of full scale.

WRITE FOR OUR 50-PAGE CATALOG . . . OR SEE PAGE 323 OF ELECTRONICS BUYERS GUIDE FOR MORE INFORMATION

SEE US AT BOOTH 3709,
700 AISLE, THIRD FLOOR



• When Micromatch® is built in . . . you know what's going out

* U. S. Letters Patent No. 2,588,390



M. C. JONES ELECTRONICS CO., Inc.
BRISTOL, CONNECTICUT

NEW PRODUCTS

(continued)

and information are available.
Circle P78 inside back cover.



SYNC GEAR MOTOR for strip chart recorders

HOLTZER-CABOT MOTOR DIV. of National Pneumatic Co., Inc., 125 Amory St., Boston 19, Mass., has developed a new 400-cycle motor designed for airborne strip chart recorders and other applications.

The new motor, which is physically interchangeable with type RBC-2505 60-cycle motors, is designed for 115 v, 400 cycle, 100 rpm, 7.5 oz in., continuous duty rating. It will also be available with other speeds, both synchronous and induction, with ratings adjusted to corresponding gear reductions. Circle P79 inside back cover.

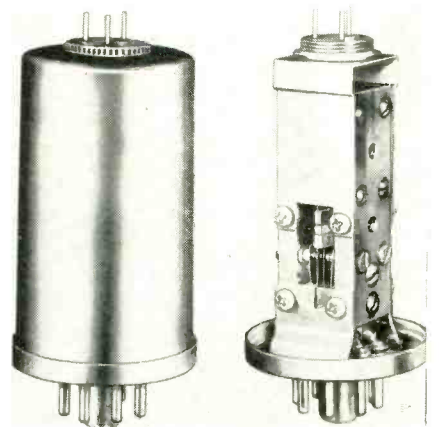

CHOPPER PACKAGE features reduced size

JAMES VIBRAPOWR Co., 4050 N. Rockwell St., Chicago 18, Ill. The new 1200 series chopper package features reduced size, improved shielding and better dust seal. The chopper is 2 3/8 in. high overall,

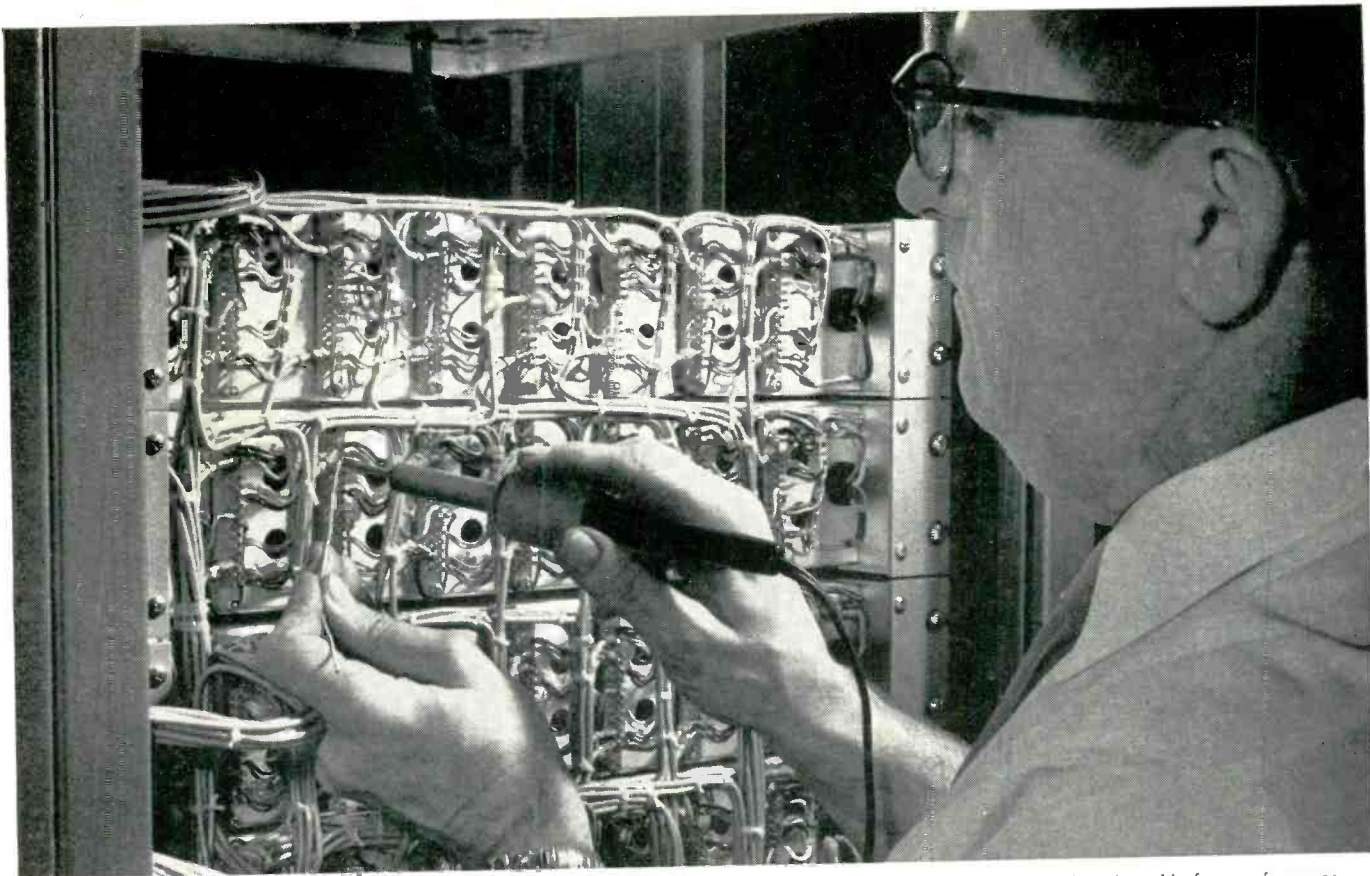

In hundreds of applications, such as this computer, R/M "Teflon" tape-covered wire offers the ultimate in dielectric strength and trouble-free performance.

For better design and performance specify R/M Teflon* products

A unique combination of properties—electrical, thermal and mechanical—makes R/M "Teflon" ideal for use as insulation, particularly at high temperatures and high frequencies. R/M "Teflon" Tape, for example, has been extensively used to insulate hookup wire for complex circuits. This tape has great toughness and resiliency, is easy to handle, conforms well to odd shapes, and can be readily adapted to automatic wrapping operations. With the trend toward miniaturization resulting in higher operating temperatures, the excellent heat resistance of R/M "Teflon" permits much greater freedom in design than ordinary dielectric materials.

Here are some of the electrical

properties of R/M "Teflon":

1. **Power factor** — less than 0.0003 over entire spectrum from 60 cycles to 30,000 megacycles
2. **Volume resistivity** — greater than 10^{15} ohm-cm, even after prolonged soaking in water
3. **Surface resistivity**— 3.6×10^{12} ohms even at 100% humidity
4. **Good arc resistance** — on exposure to an arc, the material vaporizes, leaving no carbonized path
5. **High short-time dielectric strength**— from 1000 to 2000 volts per mil, depending on thickness
6. **Good temperature resistance**— electrical properties are essentially unchanged up to at least 400°F.

R/M pioneered in developing the potentials of "Teflon" for the electrical and electronics industries. So R/M

engineers are in a specially good position to help solve your problems—call on them. And remember, we fabricate "Teflon" to specifications or supply it in rods, sheets, tubes, and tape in all standard color codings. Send for our bulletin "R/M Teflon Products."

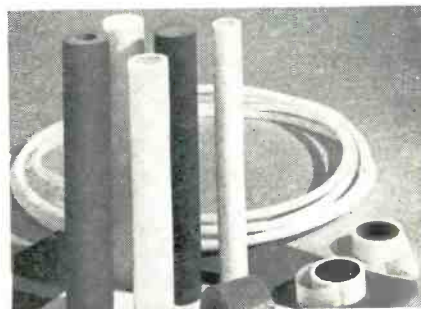

*A Du Pont trademark



RAYBESTOS-MANHATTAN, INC.

PLASTIC PRODUCTS DIVISION, MANHEIM, PA.

FACTORIES: Manheim, Pa.; Bridgeport, Conn.; No. Charleston, S.C.; Passaic, N.J.; Neenah, Wis.; Crawfordsville, Ind.; Peterborough, Ontario, Canada

RAYBESTOS-MANHATTAN, INC., Engineered Plastics • Asbestos Textiles • Mechanical Packings • Industrial Rubber • Sintered Metal Products • Rubber Covered Equipment • Abrasive and Diamond Wheels • Brake Linings • Brake Blocks • Clutch Facings • Laundry Pads and Covers • Industrial Adhesives • Bowling Balls

OFF-THE-SHELF-SERVICE

on precision
DIAMONITE
high alumina ceramic parts

SAVES MONTHS BETWEEN PRINTS AND PRODUCTION

Now you can spare yourself the enthusiasm-dampening frustration of waiting months for ceramic parts necessary to try out your ideas and put them in production.

Supplementing its large-scale mass-production facilities, Diamonite now maintains large, comprehensive inventories of hundreds of precision high alumina parts in the form of rings, cylinders, tubes and rods. By adapting these standard parts to your specific projects, *you can have them in your hands in a matter of hours.*

On the other hand, if you require a specialized shape for development work, the new Diamonite pilot plant can usually have one or a few ready to ship in a matter of days.

If you have a project on the boards or ready for production, it will pay you to check the Diamonite Off-the-Shelf Inventory List as a means toward better deliveries, better costs and better quality. If you require engineered shapes, air mail your prints for prices and delivery.

Write today for a copy of the Diamonite Off-the-Shelf Inventory and Price List . . .

or pick it up at . . . **The DIAMONITE Exhibit**
Booth 4217 I.R.E. Show
Coliseum, New York
March 18 - 21



products
manufacturing
company
Canton 2, Ohio

REPRESENTATIVES
IN PRINCIPAL CITIES

Western Regional Office: 10623 Richeon Ave., Downey, Calif.

1½ in. in diameter and painted to military specifications.

This improved chopper is now in volume production in all models and operating frequencies. Complete specifications and operating characteristics are available on request. Circle P80 inside back cover.

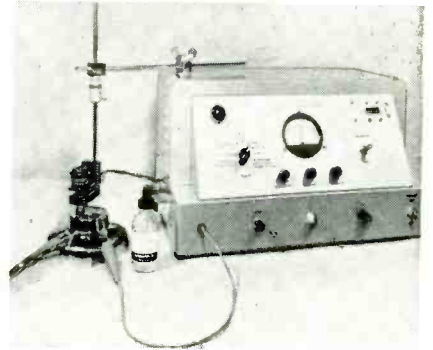

THICKNESS TESTER

insures long term accuracy

Kocour Co., 4800 S. St. Louis Ave., Chicago 32, Ill. Model 955 electronic thickness tester determines the thickness of plating and other metallic coatings deposited over various metals and non-metallic base materials with an accuracy of 90 to 95 percent. Operation is virtually automatic. Readings are direct. A multiple position switch indicates the plating to be tested.

Accuracy of the instrument can be checked at any time, and a calibration adjustment will automatically correct high or low readings, insuring long term accuracy. A constant pressure device which automatically maintains a uniform pressure between test cell and specimen eliminates reliance on operator's judgment. Circle P81 inside back cover.

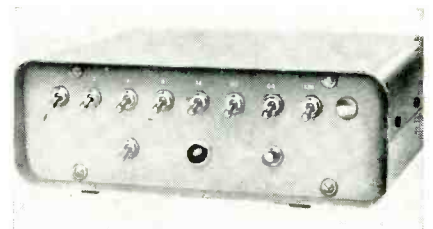

DIGITAL COUNTER

a transistorized unit

NADER MFG. Co., 2661 Myrtle Ave., Monrovia, Calif., announces a new

Potter & Brumfield engineering is in this picture



The rig is down. A part is needed fast! A call to the warehouse on a mobile 2-way radio gets action, saves money, keeps production flowing.

Which P&B relay would you specify to keep conversation going over a **MOBILE 2-WAY RADIO?**



MB Series

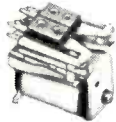

TS Series



MC Series

When one of America's leading manufacturers of electrical and electronic equipment began the design of a lightweight 2-way car radio, they were faced with several specific requirements in selection of relays. They had to be compact, light in weight and engineered to withstand the shock and vibration of off-the-road service. P&B engineering solved the problem with a modification of the TS series multiple switching relay.

In this application the TS relay has a dual personality. It connects the power supply unit to *both* the transmitter and the receiver. Power supply is controlled through the relay to either unit by the operator.

This is just another example of how P&B engineering is daily adapting standard types of relays or designing completely new types to meet specific requirements of new products. P&B's unique 25 years of engineering experience in relay applications is a source of quick, correct answers to your relay problems. Write today for new compact catalog.

ENGINEERING DATA

SERIES: TS Miniature off-set springs telephone type.
CONTACTS: 5/64" dia. palladium (rated 3 amps.) 1/8" dia. pure silver (rated 5 amps.).
CONTACT ARRANGEMENTS: Up to 20 springs, maximum 10 in each stack, using any form combinations within max. limits.
VOLTAGE RANGE: DC: up to 220 V. AC: up to 230 V. (4 poles).
COIL RESISTANCE: 30,000 ohms. Shaded coil available for 60 cycle operation up to 230 V. using 4.7 VA nominal.
POWER REQUIRED: 100 mw. per movable arm.
TEMPERATURE RANGE: Stack insulation of XXX phenolic spacers: -55° C. to +85° C. Glass malamine spacers: -55° C. to +125° C.
TERMINALS: Pierced solder lug holes for 2 No. 16 hook-up wires. Also available: Push-on taper tab connectors.
ENCLOSURES: Dust cover or hermetically sealed enclosures: Round: With octal plug (Max. of 8 springs) Rectangular: With octal plug. 4 to 14 pierced solder lugs: header to fit 14-pin miniature relay socket. Multiple solder header 18 springs Max.
DIMENSIONS: (4 Form C) 1-19/32" L. x 1-1/16" W. x 1 1/2" H. (open) (4 Form C) 1 3/4" L. x 1-13/32" W. x 2-3/16" H. (Hermetically sealed) (6 Form C) 1-29/32" L. x 1-5/16" W. x 2-9/16" H. (Hermetically sealed).
 The standard TS structure with a life of 100 million operations will soon be available.

P&B STANDARD RELAYS ARE AVAILABLE AT YOUR LOCAL ELECTRONIC, ELECTRICAL AND REFRIGERATION DISTRIBUTORS

Potter & Brumfield, inc.

PRINCETON, INDIANA

See our catalog in

Sweet's Product Design File.

Subsidiary of AMERICAN MACHINE & FOUNDRY COMPANY Manufacturing Divisions also in Franklin, Ky. and Laconia, N. H.



Insure Product Performance...

REVERE SPECIALTY WIRES

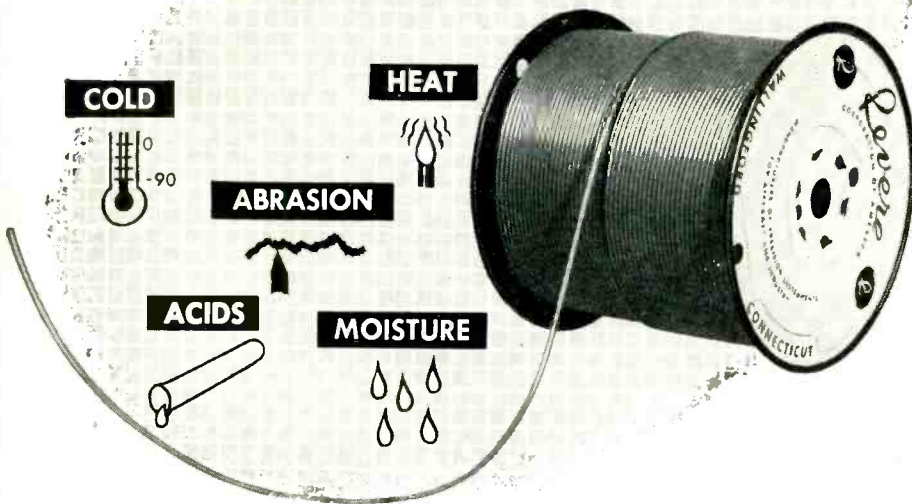

For those tough design jobs where ordinary hook-up and thermocouple wires die from the heat, get brittle in cold, abrade and corrode . . . Revere SPECIALTY wires stand up. Built to MIL and customer specifications. Range includes:

For High Temperatures

REVCOTHENE—(Extruded Monochlorotrifluoroethylene) —40°F to +275°F, AWG 28 to 10, silver-plated copper conductors, inert, excellent dielectric strength, no volatile plasticizers, non-flammable, thin wall, abrasion and moisture resistant.

PERMACODE — Teflon[®] insulated wire with striping down to the conductor for permanent identification, single or multiple stripes, 15 colors, -130°F to +410°F, AWG 28 to 16, silver-plated copper conductors, excellent abrasion and dielectric characteristics.

For Extremely High Temperatures

Fiber glass (to 700°F), asbestos (to 900°F), pure silica glass fiber (to 1500°F) wrapped or carded with outer braid and saturant as required by application.

A variety of telemetering and other multi-conductor cables constructed to customer specifications. Teflon, polyethylene, polyvinyl, nylon, glass, Revcothene, asbestos insulations for singles and jackets. Twisting, braiding, shielding, color coding to suit conditions.

Iron-constantan, copper-constantan, Chromel-Alumel conductors, AWG 36 to 14, various insulation combinations and protective braids, temperature range from -100°F to +1500°F, constructed to rigid tolerances.

*E. I. du Pont trademark

Saturants for flame and abrasion resistance, metallic braids for severe service and electrical shielding. Color coding in 15 solid colors and stripes.

Prompt delivery of standard stock wires. Write for samples and literature on specialty hook-up or thermocouple wire.

See us at the IRE Show—Booth 4118

Revere CORPORATION OF AMERICA



20

WALLINGFORD, CONNECTICUT A Subsidiary of Neptune Meter Company

transistorized digital counter. Teamed with appropriate conversion equipment, the unit counts articles, distance, degrees of rotation or angular measurements, at high speeds. Small size and moderate cost are obtained by employing printed circuit boards and modular construction. Total power consumption of the counter (two w) is no more than the filament power required by a typical tube.

► **Specifications** — Counting frequency is 15,000 cps, with higher speed provided as a special; input power, 60-cycle, 85 to 140 v; and resolution, 10 μsec. Size is four in. high by 11 3/8 in. wide by 9 1/2 in. deep. The counter can be pre-set anywhere from one to 500 for batch counting.

In operation, the output of a suitable transducer is sent to transistorized flip-flops within the counter. These in turn, when the desired number is reached, cause an output relay to function. Selling price is below \$400 and includes counsel on how to use the unit and help in engineering it into a system. Literature is available on request. **Circle P82 inside back cover.**

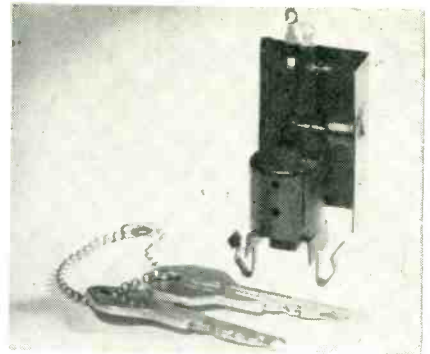

GERMANIUM RECTIFIERS for mass-produced tv sets

GENERAL ELECTRIC Co., Syracuse, N. Y. A new line of germanium rectifiers are the first ones electrically and mechanically designed by the company for tv set power supplies. The complete absence of aging effects in products made from germanium allows full rated performance over the entire life of the new rectifiers.

The new tv rectifiers also feature an extremely low forward



LARGE WAVEGUIDE

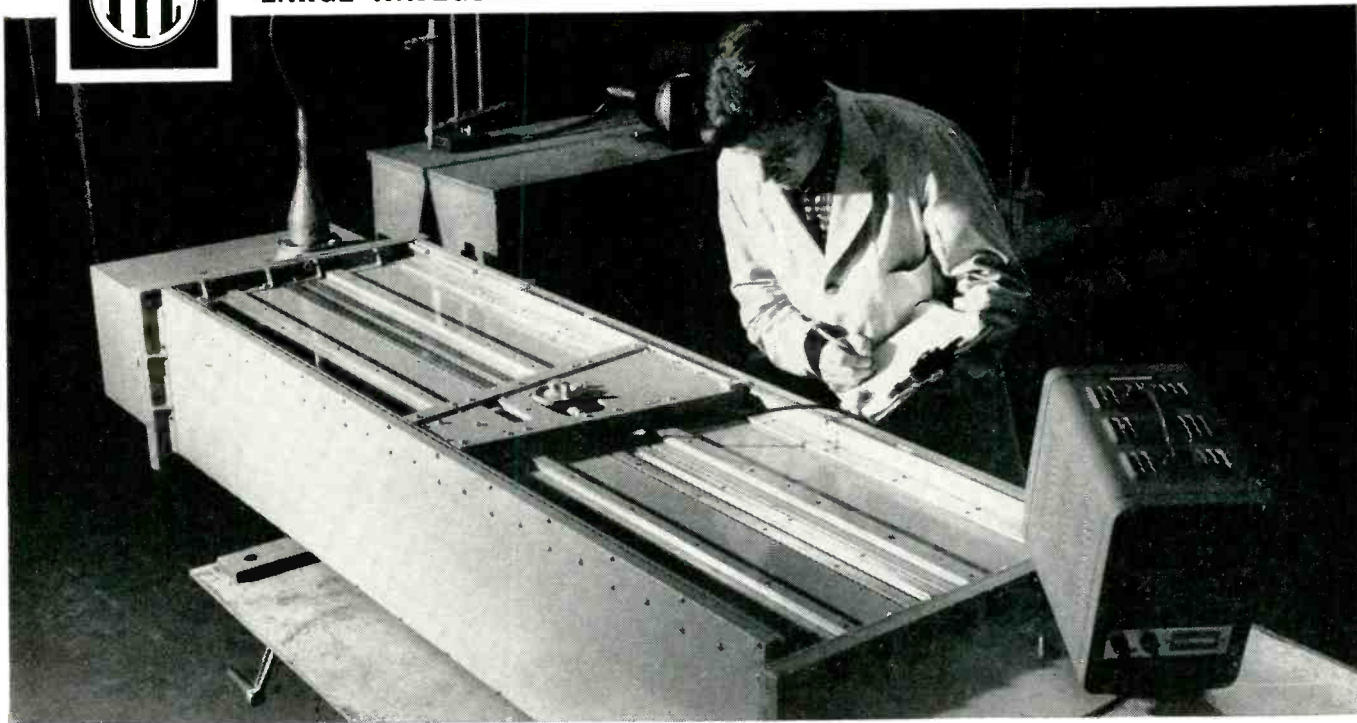

Slotted line for waveguide size WR 2100. Covers range of 350-530 mc. Probes tunable over entire band. Inherent VSWR less than 1.02—slope less than 1.01. Features bolted and doweled aluminum construction.

LARGE WAVEGUIDE & COMPONENTS WR 770 to WR 2300 (1450 down to 320 mc)

To complement the waveguide presently being supplied for major military and commercial applications in radar and scatter communications systems, we now offer a complete line of components and test equipment.

Terminations. Aluminum construction. Engineered to absorb virtually all incident power. Load is adjustable with locking device to secure it in any position.

Attenuators. Vane type designed to provide 20 db of attenuation with a minimum of mismatch. Calibration curves available.

Directional couplers. Bolted and doweled aluminum construction. Power split to customer requirements.

Special components. Including waveguide switches, duplexers, diplexers, series and shunt tees, rotary joints, and special shapes.

All items are in production now and are available on short term delivery. For more information, write I-T-E Circuit Breaker Company, Dept. 55, Special Products Division, 601 East Erie Ave., Philadelphia 34, Pa.



VISIT THE I.R.E. SHOW, March 18-21
See this equipment displayed at Booth 1313-1315

I-T-E CIRCUIT BREAKER COMPANY
Special Products Division

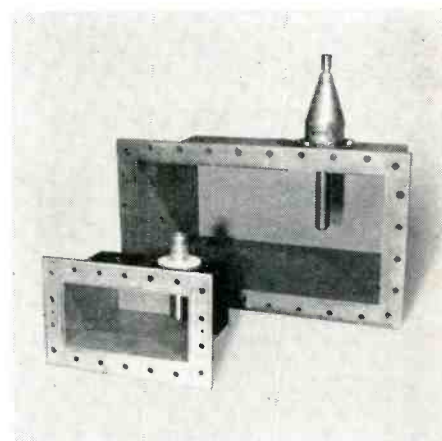

Waveguide to coaxial transitions. High-strength, lightweight aluminum construction. Supplied as standard with $3\frac{1}{8}$ in. coaxial connector (for WR 770 size, $1\frac{1}{8}$ in.). Adapters to other sizes available. All transitions designed for high power handling capacity.

Uniform toroids and high-production **economy**

**A speedy, low-cost winder with
mechanical core holder
assembly . . .**

. . . for laboratory and production

Designed for easy set up and minimum manual operation . . . TW 201 winds toroids quickly, efficiently, economically. Just one hand inserts core and removes finished coil. One lever opens and closes shuttle. Wires wound include all types of magnet and filar wire including silk, cotton, Teflon and sleeve covered wire. Toroid size ranges from .218" ID through 5" OD in wire sizes #20 through #12 AWG. Speed (fixed at 600 rpm or variable to 1200 rpm) and quickly interchangeable shuttle equipment easily adapts the Semi-Automatic to either experimental work or full-scale production. 360°, segmental and longitudinal winding . . . automatically pre-set wire and turns counters are some of many features on TW 201. For full details on this and all Boesch winders, write for Catalog 57A today.

One-piece shuttle,
speed and easy operation
of the Boesch
Fully-Automatic and
Semi-Automatic machines
make these the
industry's most capable winders.

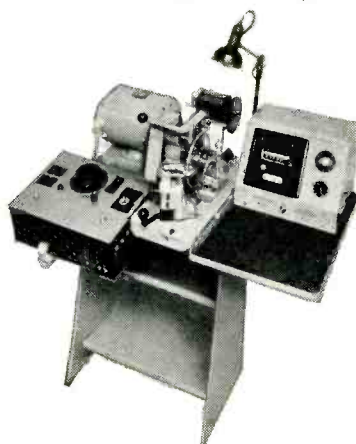

Model TW 201



*Comparison is the best test of excellence.
See for yourself why Boesch manufactures
the world's most superior winding machines.*

BOESCH MANUFACTURING CO., INC., DANBURY, CONN.

Be sure to visit BOESCH at the I. R. E. Show Booths 4301, 4302

voltage drop and thus can provide a higher d-c output than any other type of rectifier. They are designed with a mechanical snap-in type structure to help tv manufacturers minimize chassis assembly costs.

The three rectifiers are RETMA type designated 1N573, 1N575 and 1N581. The 1N573 is a half-wave rectifier capable of 250 mw d-c output. The 1N575 is designed for 350-ma d-c output. The 1N581 consists of two germanium rectifiers connected in a voltage doubler configuration and has a d-c output rating of 250 ma.

The full-cycle, average full-load voltage drop for the 1N573 is rated at a maximum of 0.15 v; for the 1N575, 0.30 v, and 0.15 v for each section of the 1N581. The rectifiers are hermetically sealed in metal cases. **Circle P83 inside back cover.**

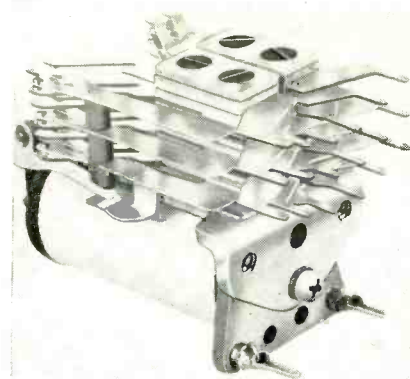

RELAY printed circuit terminals

PHILLIPS CONTROL CORP., Joliet, Ill. The type 8 relay may now be had with printed circuit terminals. These terminals are available with standard twin contact springs which have been widely used for maximum reliability in switching circuits or with single contact springs or power-type contacts for switching large current loads. For very low-level loads, gold alloy or other special contact materials are available.

Terminals are tinned for ease of soldering and for ready insertion into the circuit board. They are ribbed for added strength, fully supporting the relay and eliminating mounting screws. Terminals for the contact springs are spaced

IMPORTANT ACHIEVEMENTS AT JPL

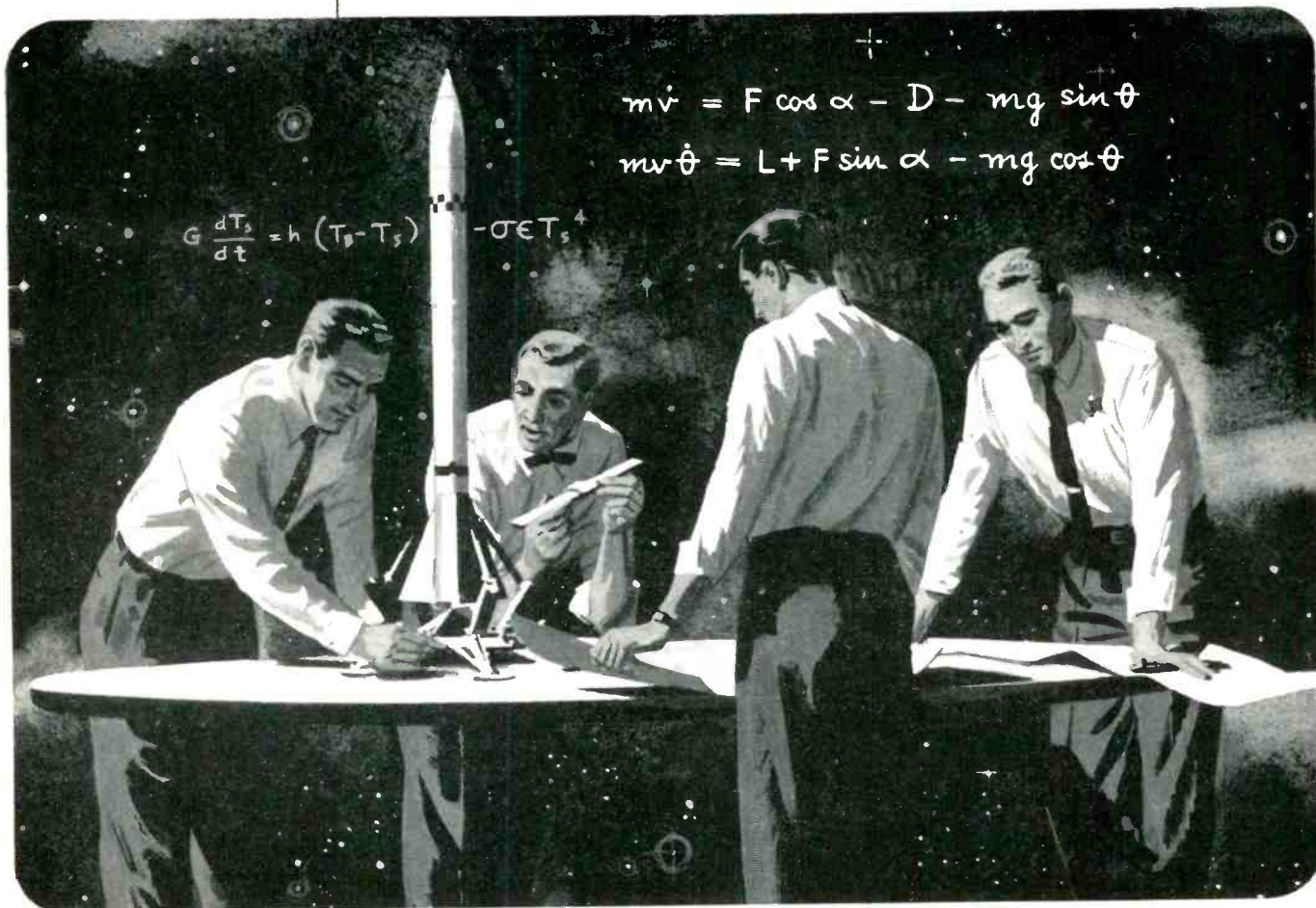

Engineering Teamwork in Missile Development

The Jet Propulsion Laboratory is a stable research and development center located north of Pasadena in the foothills of the San Gabriel mountains. Covering an 80 acre area and employing 1700 people, it is close to attractive residential areas.

The Laboratory is staffed by the California Institute of Technology and develops its many projects in basic research under contract with the U.S. Government.

Opportunities open to qualified engineers of U.S. citizenship. Inquiries now invited.

Engineers and scientists interested in a wide range of activities will appreciate the fluid character of the research and development projects in progress at the Jet Propulsion Laboratory. These projects include research in the fields of Electronics, Physics, Applied Mathematics as well as the design, development and analysis of guided missile systems.

These men, though individually responsible, work together as a thoroughly integrated team on all of the aspects of the entire missile system instead of concentrating on certain highly specialized missile components.

Since this work includes projects involving guidance, electronics, systems analysis, structures, propulsion etc., which are constantly influenced by continuing Laboratory research, the comprehensive program con-

tains problems which are challenging to individuals with interests in virtually every phase of engineering and science.

The great diversity of activity and constant progress being made in the various fields of endeavor by the staff of the Jet Propulsion Laboratory has proved to be a stimulating attraction to qualified people interested in pioneering in basic research, applied research and development engineering in the guided missile field. The result of this has been to bring together a congenial group of forward-looking engineers and scientists who are intensely interested in the pioneering projects now in progress at the Laboratory.

Additional men of this type are needed and if you are interested and feel you are qualified, send your resume today for immediate consideration.

JOB OPPORTUNITIES
ARE NOW AVAILABLE



ELECTRONICS • PHYSICS • SYSTEMS ANALYSIS
COMPUTER DEVELOPMENT • INSTRUMENTATION
TELEMETERING AND MECHANICAL ENGINEERING

JET PROPULSION LABORATORY

A DIVISION OF CALIFORNIA INSTITUTE OF TECHNOLOGY
PASADENA • CALIFORNIA

do you use
time
delay
relays?

Do you require **ADJUSTABILITY**?
... No Problem!

Do you require **HERMETIC SEALING**?
... No Problem!

Do you require **BOTH? NO PROBLEM** for the
A. W. HAYDON
Company

The A. W. Haydon Co. offers a complete line of
**ADJUSTABLE — HERMETICALLY
SEALED TIME DELAY RELAYS**
for operation under adverse
environmental conditions

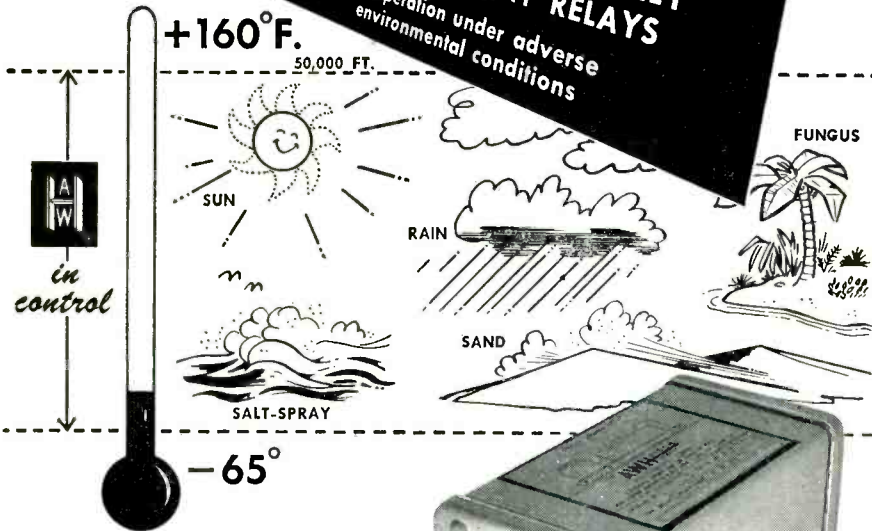

Illustrated above are a few of the many environmental conditions which these compact timers are designed to withstand. More rigid requirements frequently can be met upon special consideration.

Bulletin AWH TD401 Describes
6400 Series — DC units
11400 Series — AC units
24300 Series — 400 cycle units
Nominal Range of Adjustment: 8-1
Timers supplied with:
AN connector
Hermetic Adjusting Knob
Glass Window and Calibrated Dial
Visit us at the I.R.E. Show,
Booths 2701 & 2703

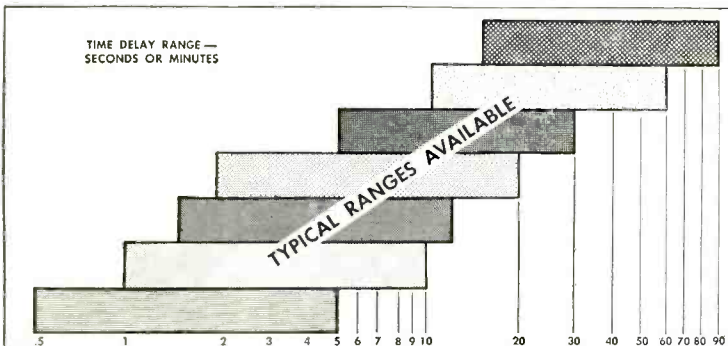
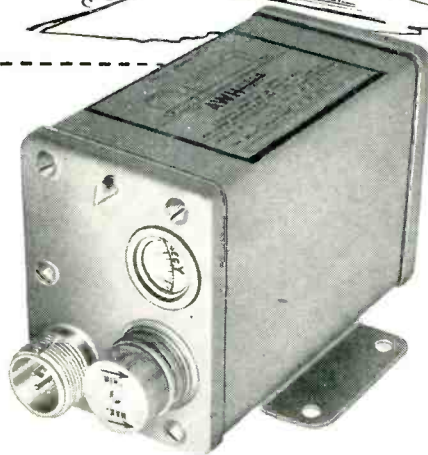

Shown in the chart are typical ranges available in these units. Special ranges frequently can be supplied to meet specific requirements.



The
A. W. HAYDON Company

Write for Bulletin AWH TD401

235 NORTH ELM STREET, WATERBURY 20, CONNECTICUT

Design and Manufacture of Electro-Mechanical Timing Devices
PREFERRED WHERE PERFORMANCE IS PARAMOUNT.

for maximum clearance but do not exceed standard dimensions of the type 8 relay. Coil terminals are located on the same centers as on the standard relay and dual coils employing four coil terminals are available. Circle P84 inside back cover.

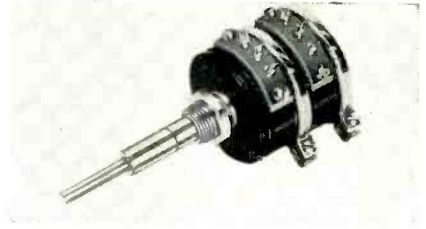

PRECISION POTS
concentric-shaft design

WATERS MFG., INC., P. O. Box 368, South Sudbury, Mass. The new concentric-shaft design, available in the company's precision pots, permits two potentiometers to be single-hole mounted for control by a dual knob. The tandem-mounted pots have standard 1/8 and 1/4-in. shafts. The assembly is mounted by the usual 3/8-in. threaded bushing or can be supplied with servo-style mounting.

The concentric-shaft potentiometer assembly, type APC-1-4, can be furnished with any combination of the resistance ranges available in Waters AP-1-4 or RTS-1/2 pots, with stops, or for continuous rotation of either or both elements. Circle P85 inside back cover.



CAPACITORS
with ceramic dielectric

CAMBRIDGE THERMIONIC CORP., Cambridge, Mass., announces a rugged new series of stand-off capacitors with ceramic dielectric, series X2122. Available in a group of values, they are general r-f bypass capacitors for use in high quality electronic equipment.

The encapsulating resin provides exceptional rigidity and durability under extreme condi-

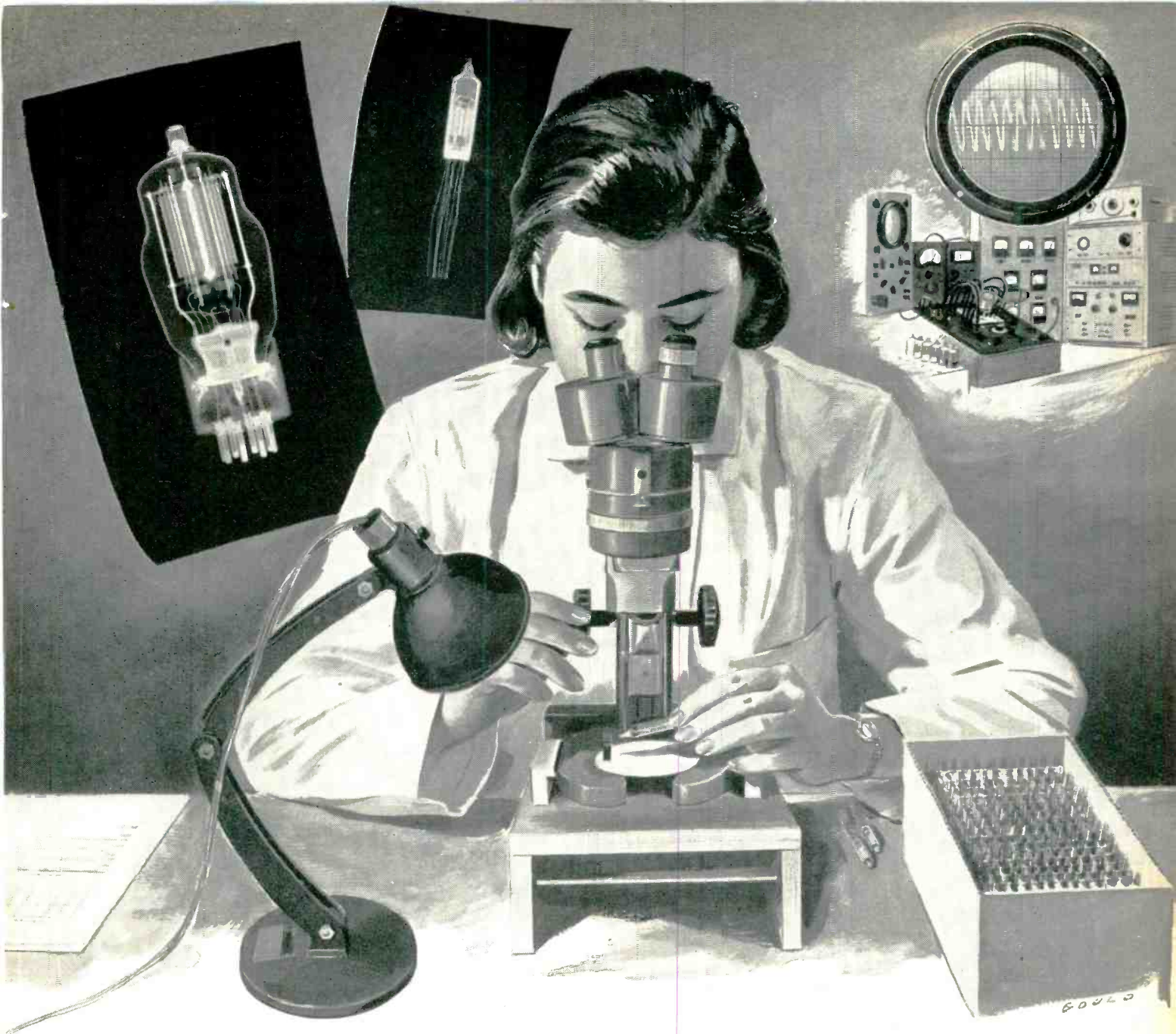

"An infinite capacity for taking pains"

The above familiar phrase is usually given as a definition of genius. We borrow it as a job description.

The lengths to which our Quality Control people go, to insure the reliability of our complex products, are truly painstaking, and are applied equally to components we make ourselves and those we purchase from outside suppliers.

For example, consider vacuum tubes, the heart of hundreds of projects in our Electronics Division. No spot check satisfies here (even if that's all our customer specifies)—but a whole series of critical tests, including such precise evaluations as these:

Inspection of tube characteristics to rigid Stromberg-Carlson specifications—performed on special equipment

which can do in a half-hour what would take days on conventional testing devices.

Inspection by X-ray, looking for deeply hidden potential faults which could cause malfunction at any time after first use.

Inspection by microscope, seeking welding faults, minute cracks in glass, and even infinitesimal loose particles inside the tube.

And tubes are only one concern. *All* components must pass similarly rigid tests, to assure operating performance, ruggedness and reliability in the completed equipment.

You can't put a price on "taking infinite pains." You can place your confidence in a company where this is everyday procedure.



STROMBERG-CARLSON COMPANY

A DIVISION OF GENERAL DYNAMICS CORPORATION

General Offices and Factories at Rochester, N. Y.—West Coast plants at San Diego and Los Angeles, Calif.



How
PHILCO
protects transistor quality
 with **3-D**
 MICRO-VISION



From quality control on automated assembly lines to final inspection, Bausch & Lomb Stereomicroscopes assure precision production at the Lansdale Tube Company, Division of Philco Corporation. Inspectors see clear, sharp magnified views of tiny transistor components barely visible to the unaided eye. Work is seen right-side-up, in natural 3-dimensional relief. Freedom from eyestrain and discomfort increases efficiency. The result: precision standards that assure distortion-free sound in Philco-equipped transistor radios... speed and reliability in Philco-equipped computers.

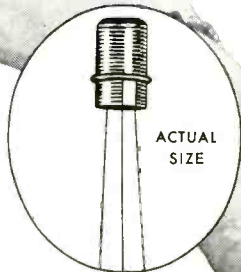

**MAIL COUPON TODAY FOR VALUABLE
 3-D MICRO-VISION DATA BOOK**

BAUSCH & LOMB OPTICAL CO.
 61415 ST. PAUL ST., ROCHESTER 2, N. Y.

Please send me Stereomicroscope Manual D-15, including actual stereo views, how and where to use stereomicroscopes, and Selector-Chart which fits exact model to specific job needs.

NAME.....
 TITLE.....
 COMPANY.....
 ADDRESS.....
 CITY..... ZONE..... STATE.....

BAUSCH & LOMB



America's only complete optical source... from glass to finished product.

NEW PRODUCTS

(continued)

tions of shock, vibration and humidity. A unique design feature minimizes breakage of the dielectric ceramic due to flexing of the chassis and mounting surfaces.

The X2122 capacitors mount by a single 6-32 threaded stud, $\frac{1}{4}$ in. long. Overall height when mounted is less than $\frac{3}{8}$ in. The mounting stud is $\frac{1}{16}$ in. hexagonal brass that has been gold flashed. The solder terminal is also gold-flashed brass. Circle P86 inside back cover.



ARMORED RELAYS
 in 1, 2 and 3-pole models

EBERT ELECTRONICS CORP., 212-26 Jamaica Ave., Queens Village 28, N. Y., has available a full line of accident-proof armored mercury plunger relays. Illustrated is one of the many models, the spst HDC-1 for all loads up to 60 amperes at 115 v, a-c.

These rugged encapsulated-tube relays were specifically designed to withstand shocks, blows and physical impact. The standard 35-ampere or heavy duty 60-ampere hermetically sealed, mercury-to-mercury action contactor tubes are potted in special high-temperature material and plasticated, rigid aluminum shells.

For corrosive atmospheres, the company's relay coils are also available in all standard operating voltages, fully encapsulated in approved polyester resin compound. By carrying their own armor and

Honeywell Preamplifiers combine isolated input with accuracy of 1 part in 2,000 in the CEC MilliSADIC

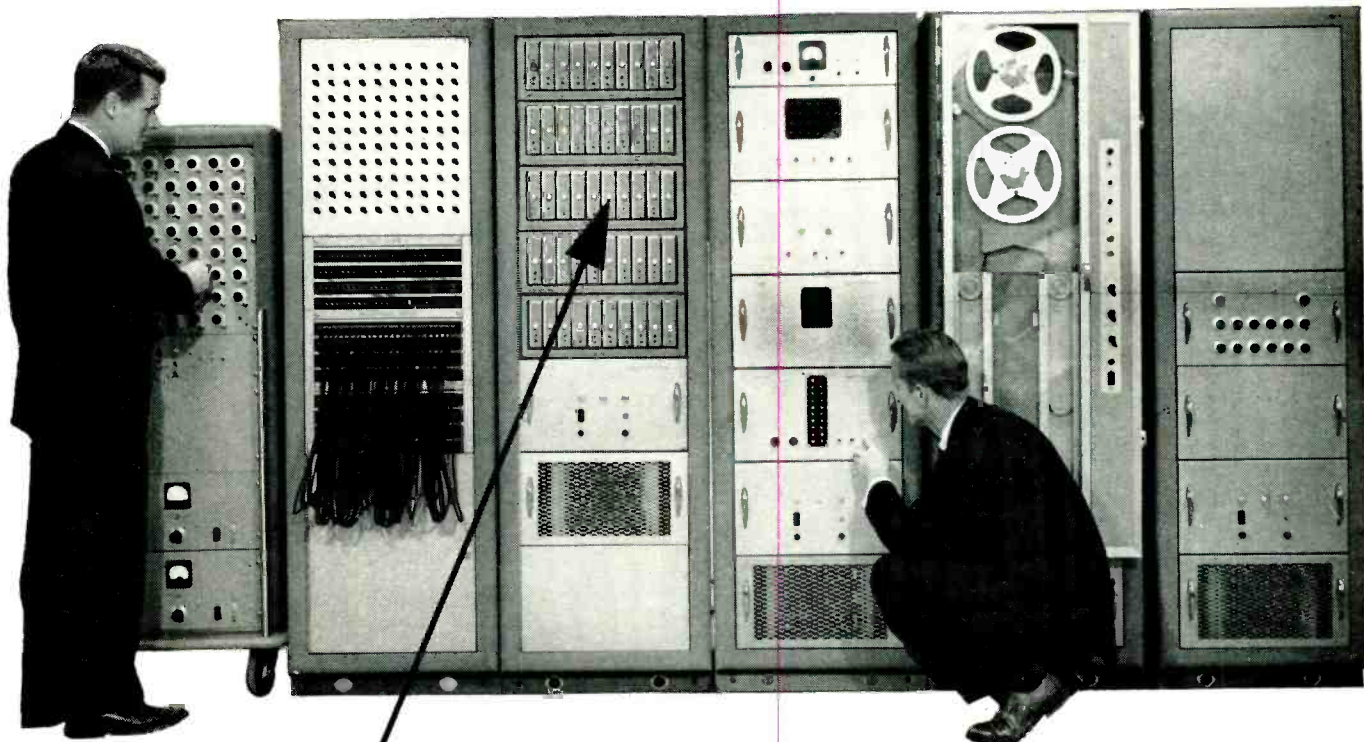

Consol dated Electrodynamic Corporation's MilliSADIC Installation for General Electric's Aircraft Nuclear Propulsion Dept., Cincinnati samples 400 jet engine temperatures per second and stores this information in digital form.

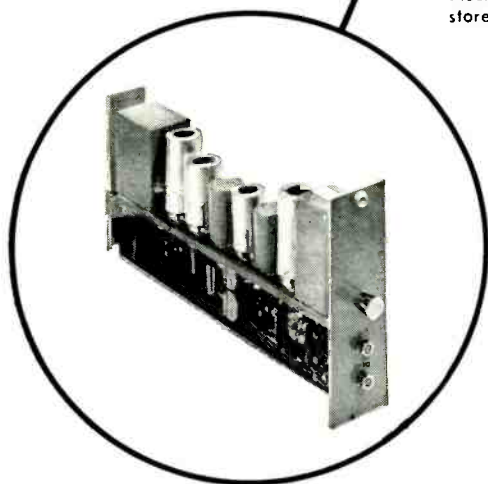

Honeywell Data Handling D-C Amplifier, Model 2HDH-2. This type is used as preamplifiers in the CEC MilliSADIC shown above.

The *isolated input* of the Honeywell Data Handling D-C Amplifiers, Model 2HDH-2 makes them ideally suited as preamplifiers to raise the input signals from thermocouples and strain gauges to the level required by the analog-to-digital conversion system of CEC's MilliSADIC installation at General Electric's Aircraft Nuclear Propulsion Dept., Cincinnati. The low noise level, high degree of linearity and zero and gain stability of these amplifiers provide the accuracy of 1 part in 2,000 required for this application. The exclusive Honeywell Second Harmonic Converter as the input element of these amplifiers provides the bonus features of ultra high common mode rejection and resistance to pick-up.

Honeywell Data Handling D-C Amplifiers, 2HDH Series, are compact plug-in, rack-mounted units specifically designed for use as preamplifiers in data processing systems. These amplifiers are available in the input range, rise time, frequency response or gain specifications required by many data processing systems. Other amplifiers in this series can accept as many as 150 separate D-C signals per second. Write for Bulletin 2HDH . . . Minneapolis-Honeywell, Boston Division, Dept. 7, 1400 Soldiers Field Road, Boston 35, Mass.

MINNEAPOLIS
Honeywell 

BOSTON DIVISION

For Small Spaces, High Temperatures

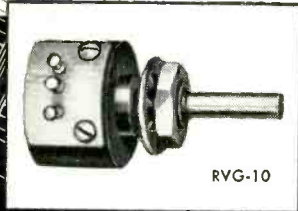
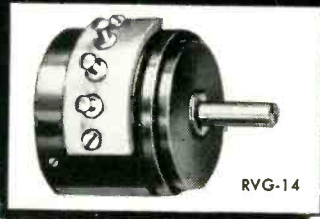

GAMEWELL RVG SERIES Miniature **PRECISION** POTENTIOMETERS



These Gamewell pots — $\frac{5}{8}$ ", $\frac{7}{8}$ " and $\frac{1}{16}$ " — provide superior characteristics in miniature size . . . ideal for high temperatures and other environmental extremes. All have anodized aluminum bodies, stainless steel shafts, excellent linearity and meet MIL-E-5272A specs as they apply. RVG-17XS has a specialized arrangement which produces sine-cosine functions with unique precision and smoothness.

For dependable performance under rugged environmental conditions and severe space restrictions, specify one of these RVG Precision Potentiometers. Many special features and modifications are also available to meet your specific need. Write or call for details.

THE GAMEWELL COMPANY
NEWTON UPPER FALLS 64, MASS.

GAMEWELL

PRECISION POTENTIOMETERS

GA6-18

Check these dimensions
for reducing
"package" size

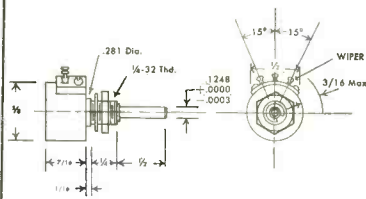

RVG-10

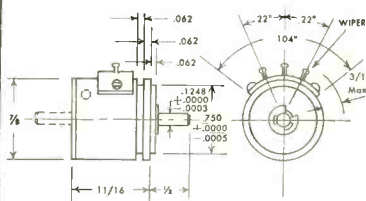

RVG-14

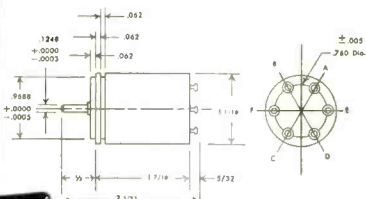

RVG-17XS

SPECIAL!
Send for New catalog
with data on complete
line.

NEW PRODUCTS

(continued)

having hermetically sealed non-wearing contacts, these mercury plunger relays require no more than ordinary general-purpose enclosures in most applications. Detailed information and prices are available. Circle P87 inside back cover.



DETECTOR UNIT checks missing pulses

MANSON LABORATORIES, 207 Greenwich Ave., Stamford, Conn. Model PD11A is a precision instrument for checking the performance of pulse-modulated magnetrons, klystrons and similar types. The set incorporates two input connectors, one for the negative detected r-f pulse, the other for a negative reference trigger. The r-f pulse is integrated and used to fashion a negative gate for squelching the reference trigger. In the case of a missing pulse, the output is a positive 15-v pulse registered on a counter.

Complete technical specifications are available in a descriptive bulletin. Circle P88 inside back cover.

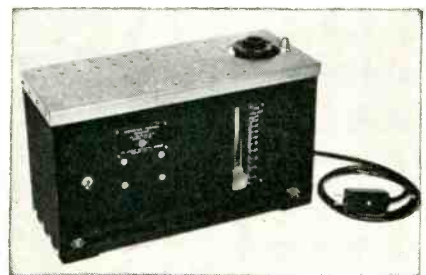

VIBRATION TESTER meets MIL-Std-202 specs

THE AHRENDT INSTRUMENT Co.,
4910 Calvert Road, College Park,
Md. Model 14-28 vibration test-

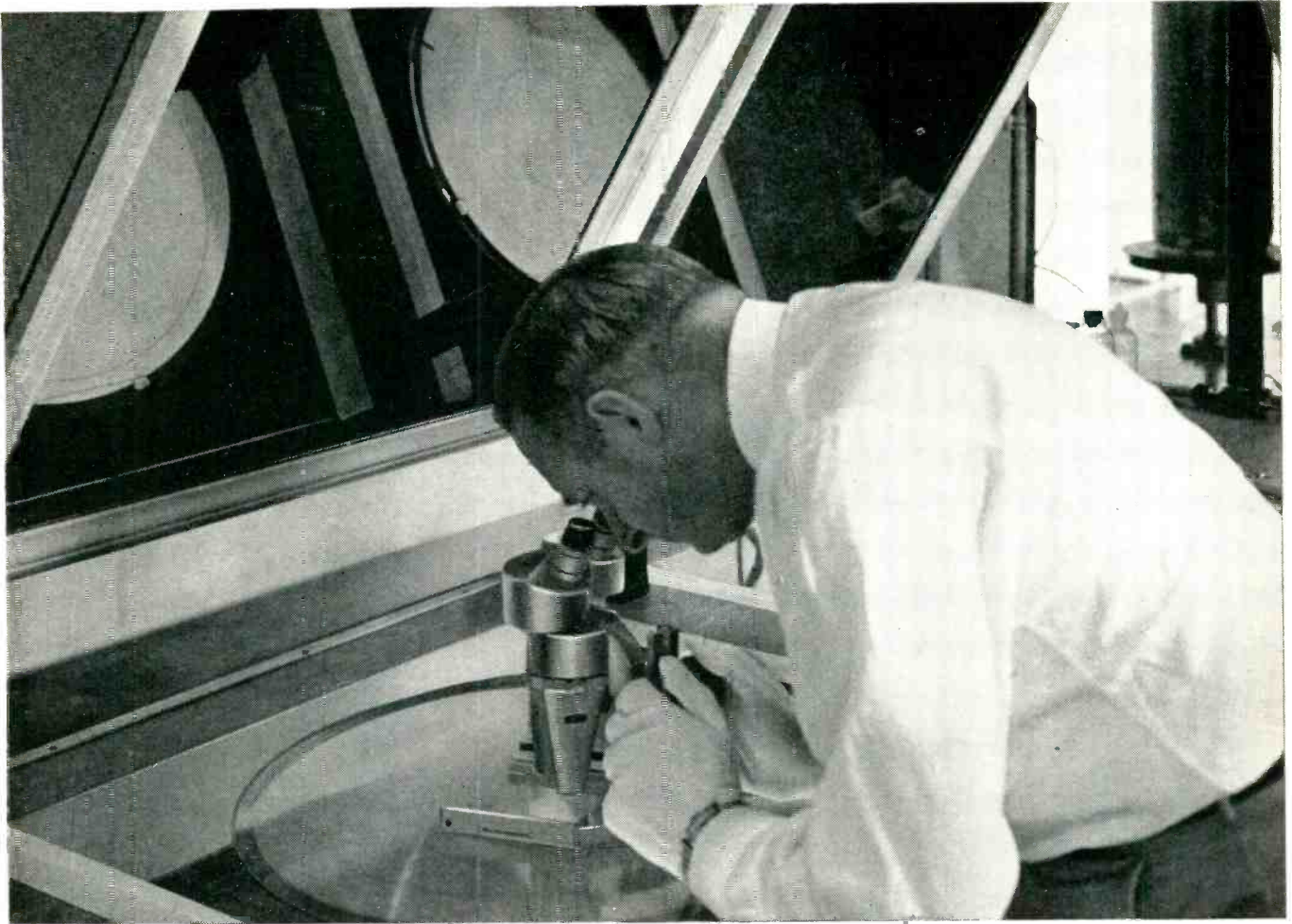

Get Sharper, Truer Color TV Pictures

New tapered-hole aperture mask reduces beam diffusion . . . minimizes false color . . . can be used in present design picture tubes

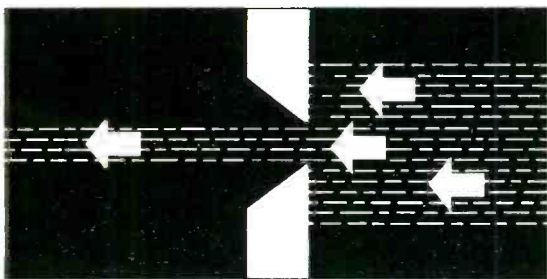

NEW tapered-hole aperture mask. See how electron beam passes through hole without diffusion. Hole dimensions: .010 in. small diameter; .015 in. large diameter. There are nearly 500,000 of these holes in each mask—all controlled to close tolerance.

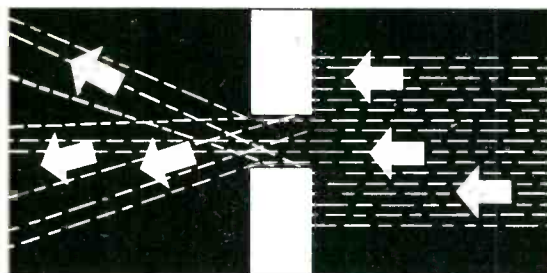

OLD cylindrical hole aperture mask. Electrons striking aperture walls are scattered over several dots.

Here's another long step forward toward better color television—one that doesn't require radical changes in circuitry or picture tube construction. It's an improved aperture mask made by Superior Tube* that can be used in the picture tubes you are now using.

Ideally, an aperture mask should have zero thickness. Because electrons impinging on the walls of cylindrical holes are deflected out of the narrow beam and sometimes strike adjacent color dots instead of the single dot they are directed at. The result is a hazy picture or false color. But with these new Superior Tube tapered-hole aperture masks, beam diffusion is practically eliminated. The walls of the tapered holes lie outside the path of beam electrons—even at the extreme edges of the picture. The electrons see only the holes.

These new aperture masks demonstrate how accurate and to what close tolerances Superior Tube can fabricate metal components. For complete information, write for Data Memo No. 5. Superior Tube Company, 2500 Germantown Ave., Norristown, Pa.

**Manufactured by Superior Tube Co. under license from Buckbee Mears, Co., St. Paul, Minn. Other parts Superior Tube makes for use in color TV receivers include three different types of disc cathodes (miniature, narrow neck and standard), seamless anodes, and a complete line of sleeve-type cathodes. Superior Tube is the world's largest independent supplier of cathodes for use in electron tubes.*

Superior Tube

The big name in small tubing
NORRISTOWN, PA.

Johnson & Hoffman Mfg. Corp., Mineola, N.Y.—an affiliated company making precision metal stampings and deep-drawn parts such as those used in the electron guns that go with this new cathode.

now—weld even “difficult” metals instantly with weldmatic stored-energy welders

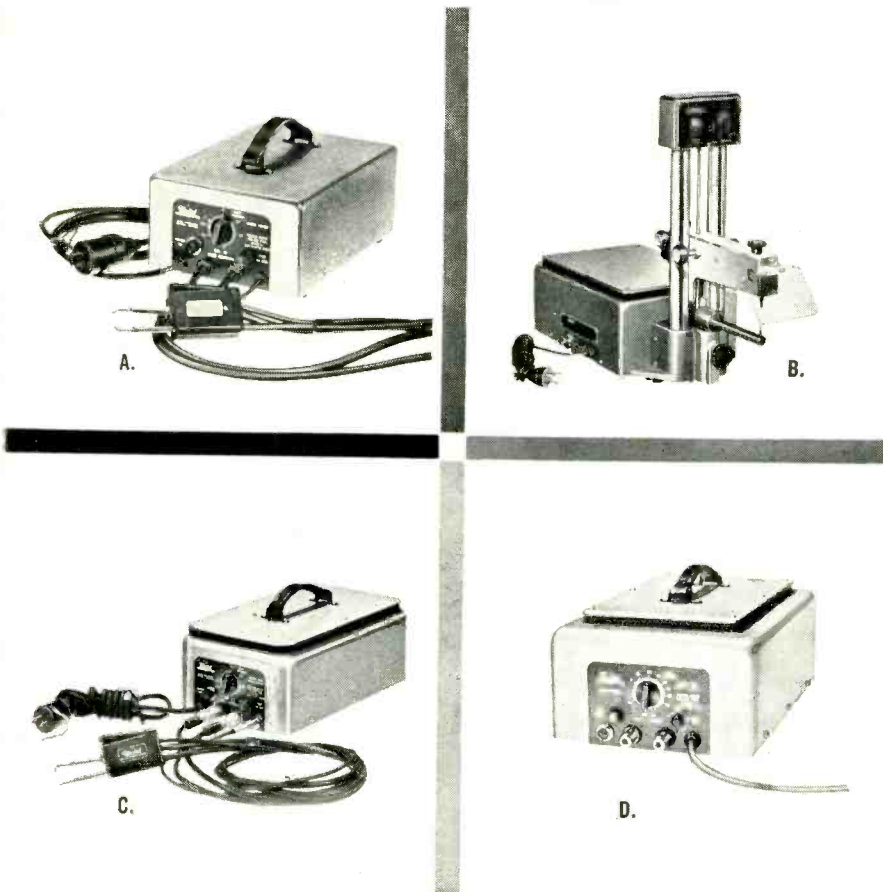

Weld stainless steel, copper, silver, tungsten, molybdenum and other “problem” metals easily and in millisecond time. Weldmatic resistance welders speed precision metal-joining operations in electronic, instrument, aviation and general industrial work, displacing slower, costlier methods such as soldering, silver brazing, riveting and staking. Weldmatic-welded joints offer better mechanical performance, higher tensile strength, better fatigue resistance. Dissimilar metals and parts of widely varying thicknesses are joined with ease and require no preconditioning. Welds are strong and uniform—no discoloration or metallurgical change, no excessive deformation. Weldmatic welders are easy to set up and simple to operate.

there's a weldmatic for every precision assembly task

- A. weldmatic model 1012—Portable, Tweezer type handpiece. Extra-long leads.
- B. weldmatic model 1015—Bench mounted. Accommodates special-purpose electrodes and handpieces.
- C. weldmatic model 1016—Portable. Has two interchangeable handpieces, extra-long leads.
- D. weldmatic model 1026—Portable power unit with readily interchangeable handpieces.

APPROXIMATE WORK CAPACITY

MODEL NUMBER	LOW CONDUCTIVITY MATERIALS		HIGH CONDUCTIVITY MATERIALS	
	Sheet Thickness	Wire Diameter	Sheet Thickness	Wire Diameter
1012	.0005 to .010	.00015 to .030	.0003 to .005	.0001 to .015
1015	.0005 to .020	.0002 to .060	.0003 to .010	.0002 to .030
1016	.0005 to .015	.0001 to .045	.0003 to .008	.0001 to .020
1026	.0005 to .020	.0002 to .060	.0003 to .010	.0002 to .030

write for descriptive literature and details of sample welding service

WELDMATIC

a division of unitek corporation

257 NORTH HALSTEAD AVENUE • PASADENA, CALIFORNIA
VISIT OUR BOOTHS #4517 & 4519 AT THE I.R.E. SHOW

ing machine is constructed on a rugged cast aluminum base which houses the drive motor and variable speed drive mechanism. Linear sinusoidal motion is imparted to the spring flexure mounted table by a connecting rod driven by a ball bearing mounted eccentric cam. The eccentric cam is driven by a cone-type variable speed drive powered by a 1/15-hp split-phase induction motor. Frequency adjustment is provided on the front of the machine. Amplitude setting is provided at the top right side of the table by means of the eccentric adjustment. Unidirectional table vibration is assured by table rigidity and unique flexure suspension system.

Specifications and an outline drawing are available on request. Price of the machine is \$295. Circle P89 inside back cover.



PULSE GENERATOR completely transistorized

CUBIC CORP., 5575 Kearny Villa Road, San Diego 11, Calif. Model 502 pulse generator is a completely transistorized test equipment using printed circuitry. It provides a pulse length from 0.5 to 3 μ sec in three steps with a 20-v peak into an 800-ohm load. The positive or negative pulses are continuously variable from zero to full amplitude and the instrument may be easily modified to accomplish external modulation.

With negligible jitter, the pulse shape shows a rise and decay time of 0.1 μ sec or less; tilt and overshoot is less than ± 2 percent over average amplitude at maximum pulse output. Repetition rate on internal sync is from 50 to 5,000 pps, and on external sync

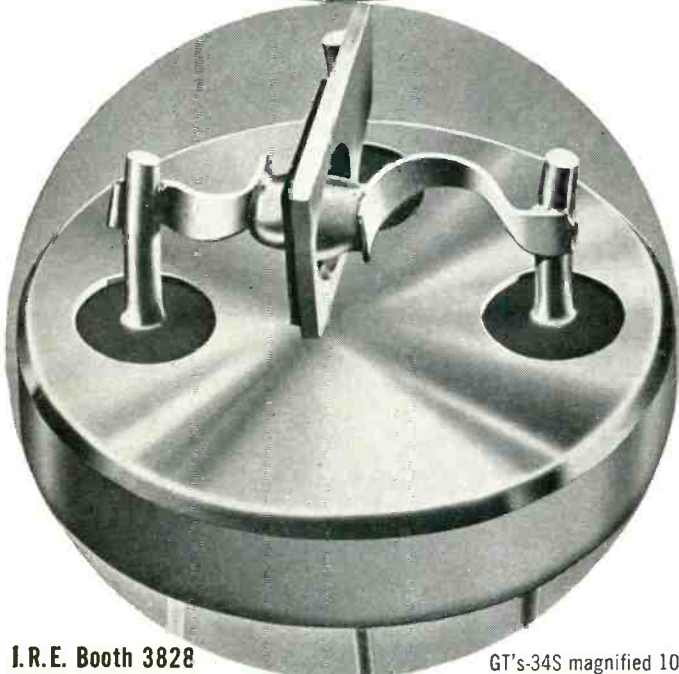

I.R.E. Booth 3828

GT's-34S magnified 10½ times.



WHEN CAN ONE TRANSISTOR REPLACE 2?

In computer or in other applications where current must be amplified in either direction, you can now specify General Transistor's new GT-34S bi-directional transistor.

As developed by GT, this symmetrical transistor can also be used as a bi-directional switch when placed in series with the load. For greater reliability, to save production time, and for compactness you should examine GT's-34S... another reason for General's leadership in the manufacture and development of transistors for computers.

Write for Bulletin GT-34S for complete specifications.

Maximum collector to base voltage	40 volts
Maximum emitter to base voltage	40 volts
Peak current	½ amp.

DC current gain is > 10 when $I_b = 20 \text{ ma}$, $V_{ce} \leq 3 \text{ V}$.

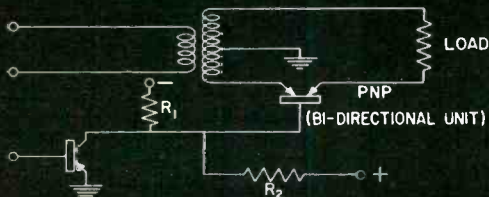

GENERAL TRANSISTOR CORP. 91-27 138th Place, Jamaica 35, N. Y.

OLympia 7-9700

ACEPOT*
ACETRIM*

Sub-Miniature Potentiometers and Trimmers

1/2" size, precision wire-wound,
up to 250K, $\pm 3\%$ linearity

setting new standards
for dependability
in sub-miniaturization

Let the facts speak for themselves! ACE Sub-Miniature Precision Wire-Wound Potentiometers and Potentiometer Trimmers are the result of 4 years development and over a year of successful use by leading electronic equipment manufacturers. Users have conclusively proved that ACEPOTS and ACETRIMS meet requirements for space and weight saving compactness, while at the same time meeting MIL specs' most stringent qualifications for performance and dependability. Why invite trouble with untested components when you can protect your reputation with ACEPOT and ACETRIM . . . the subminiature potentiometers and trimmers proved in actual use.

Condensed Engineering Data

	ACEPOT (potentiometer)	ACETRIM (trimmer)
Resistance Range	200 \sim to 250K $\pm 2\%$	10 \sim to 150K $\pm 3\%$
Linearity	$\pm 3\%$	$\pm 3\%$
Resolution	extremely high	excellent
Ambient Temperature	-55° C to 125° C*	-55° C to 125° C
Torque	low or high	low or high

The above specifications are standard — other values on special order.

Available in threaded bushing, servo, flush tapped hole or flange mounting, and ganged units. All units sealed, moistureproofed, and anti-fungus treated. Meet applicable portions of JAN specs and MIL-E-5272A standards.

*New X-500 ACEPOT operates to a new high of 150° C.

*Expedited delivery on prototypes; prompt servicing of production orders.
Send for Fact File and application data sheets.*

*trademarks applied for

ACEPOT*
ACETRIM*

ACE ELECTRONICS ASSOCIATES

Dept. E, 101 Dover St. • Somerville 44, Massachusetts
See the newest and latest at Booth 1807, the IRE Show.

NEW PRODUCTS

(continued)

from 0 to 5,000 pps. Internal impedance is 100 ohms or less on either pulse polarity. Sync may be positive or negative at 1 v minimum to 20 v peak-to-peak maximum. Sync output provides positive or negative 10 v peak into a 2,000-ohm load with a duration of approximately 1.5 μ sec at the half voltage point and a rise time of 0.5 μ sec. Pulse position is available in two ranges: 0 to 20 and 0 to 200 μ sec after sync output. Price is \$325 including battery and instruction manual. Circle P90 inside back cover.

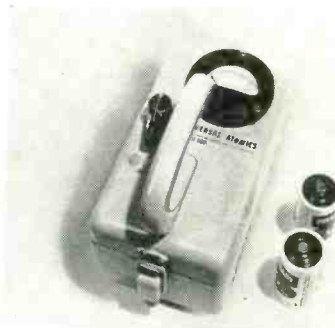

SURVEY METER

with transistorized circuit

UNIVERSAL ATOMICS CORP., 143 E. 49th St., New York 17, N. Y., has developed a highly efficient radiological survey meter model No. 407 for civilian defense units and laboratories with limited budgets. The 3½-lb unit was designed for surveying radiation dosage, leakage and contamination. It operates on two standard flashlight cells for long life; has three methods of indication (a meter, flashing light and earphone) and, due to a high gain transistorized circuit, features high efficiency. Complete cost is only \$79.50. Circle P91 inside back cover.

FILTERS, CAPACITORS

smaller, more efficient

AIRBORNE ACCESSORIES CORP., Hillside, N. J., has added to its line of aircraft equipment smaller, more efficient custom-designed filters and capacitors which meet specifications JAN-C-25, MIL-I-61-81-B and MIL-M-8609. As an example of the advantages offered by the new line, the company cites

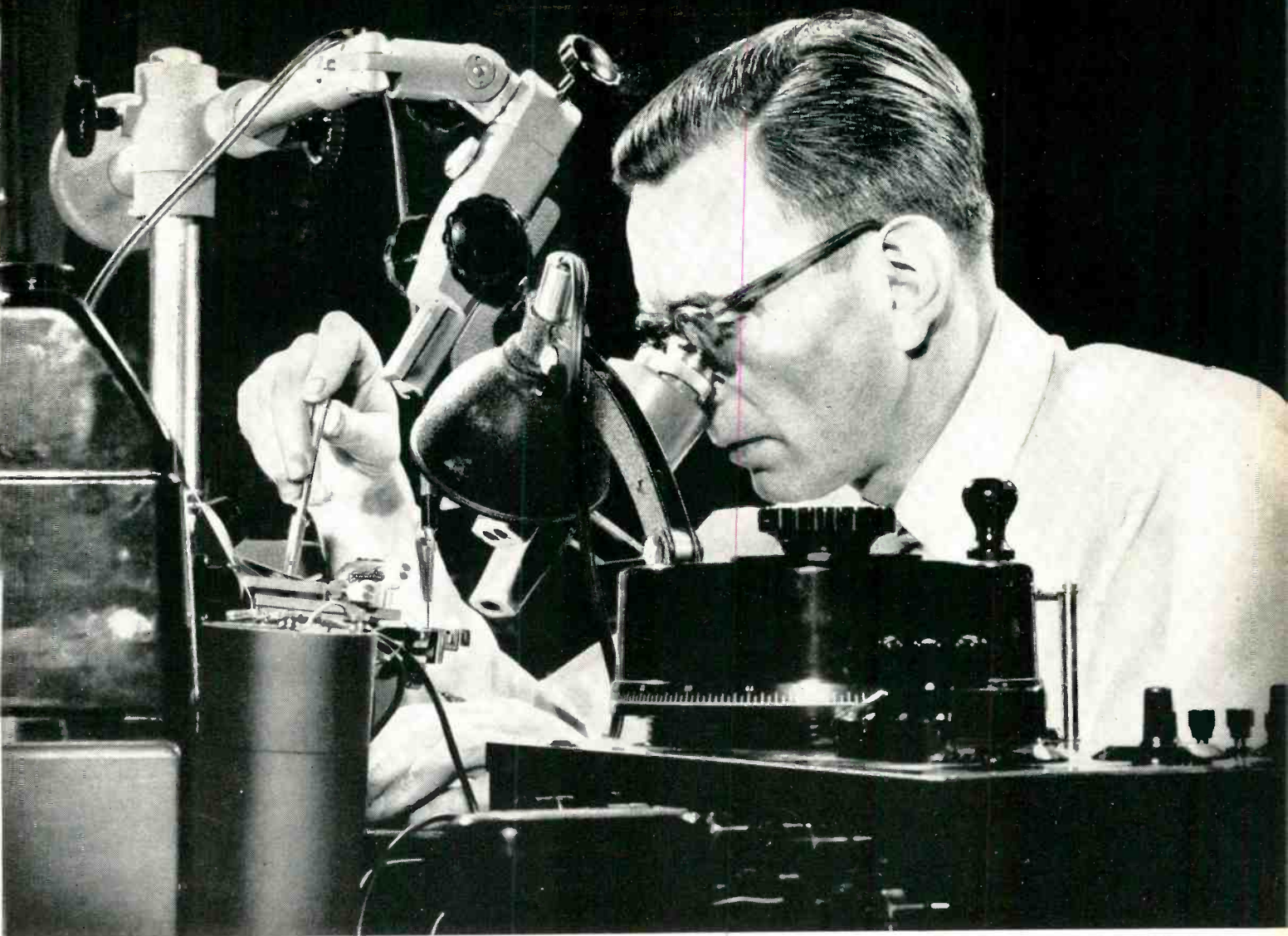

He's getting new basic knowledge on properties of semi-conductors

Here Dr. Rolf K. Mueller determines electrical properties of a semi-conductor specimen having a low angle grain boundary. He and his colleagues in the Electron Physics Laboratory of the Mechanical Division of General Mills grow their own pure specimens with carefully oriented crystal structures (germanium in this case). They then mount specimens very precisely for basic research involving the effect on physical properties of varying angles of junction. Variation of the angle of crystal orientation at the junction (the "grain boundary") has a predictable effect on the electrical reactions of the semi-conductor. Semi-conductor work is but one facet

of an integrated program in solid state physics. Studies of chemical, mechanical and surface properties of solid crystals and "sputtering" of metals under ion bombardment are among several other areas presently being researched in the Electron Physics Laboratory.

Some of this research is still basic, but it typifies the advanced and creative work we do. In many fields, this "research for tomorrow" is translated regularly into practical applications for industrial and military use today. If you have product or production problems, possibly you can profit from these applications and from our precision production facilities.

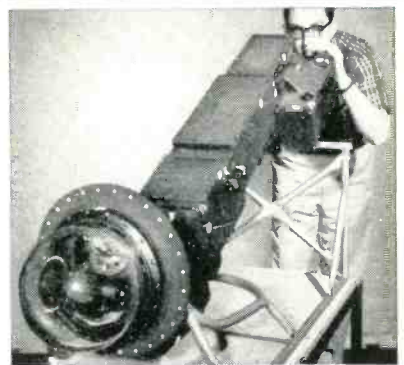

Need Precision Production Fast?

High quality and on-time delivery are characteristic of our precision production. Example: while building more than 1,500 Y-4 bombsights, we improved original design, exceeded USAF specifications, were never delinquent in shipment. We'd like to serve you similarly. Write for facts. Dept. EL-3. Mechanical Div., General Mills, Mpls. 13, Minn.

MECHANICAL DIVISION

CREATIVE RESEARCH AND DEVELOPMENT + PRECISION ENGINEERING AND PRODUCTION

**General
Mills**

when you need a
SMALLER "POT"
 Try these for size and reliability...

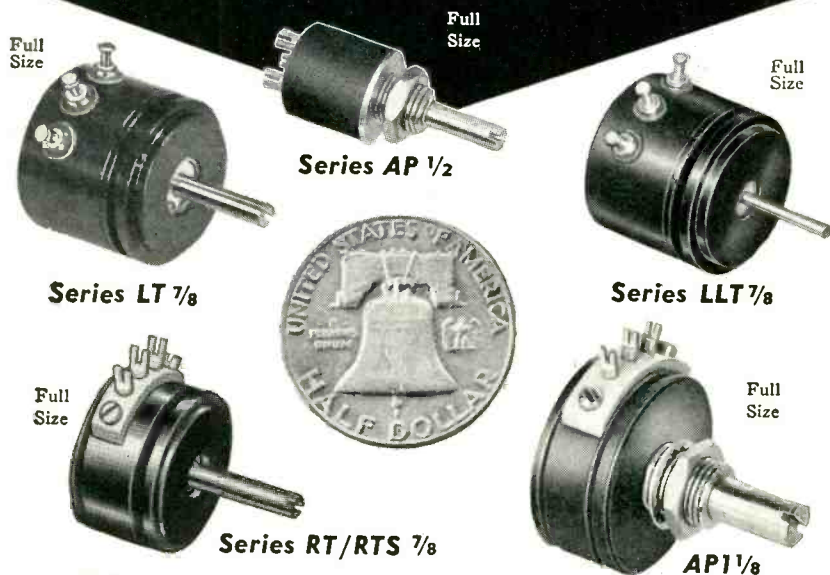

**Waters miniature and micro-miniature
 wire-wound precision potentiometers**

are famous for accuracy, ruggedness, dependability and fast delivery in commercial and military uses. They are precision-machined, with anodized aluminum bodies, line-reamed phosphor bronze, ball or jewel bearings, centerless-ground stainless steel shafts, and gold-plated fork terminals; fully sealed and fungus-proofed. To meet your requirements Waters pots can be furnished ganged, tapped, servo or bushing mounts, with various electrical and mechanical angles, optional shaft locks, anti-rotation pins, O rings, and custom shaft or servo dimensions.

Series AP 1/2 — 2 watts continuous at 80°C; resistances 10 to 100,000 ohms, 5% tolerance standard; diameter 1/2", depth 1/2" standard, weight 1/4 ounce; fully sealed for potting.

Series LT/LLT 7/8 — One watt at 80°C; resistances 100 to 100,000 ohms, ball or jewel bearing, for use in computers, servos, and selsyns where minimum torque is required. Weight is only 1/2 ounce; MAXIMUM torque is 0.01 inch-ounce per section. Ganging to six decks, internal clamps hold 7/8" diameter. Standard linearity 0.5%, on special order 0.25% above 1K; toroidal winding allows winding angles to 360°, standard is 354°.

Series RT/RTS 7/8 — 3 watts continuous at 80°C; resistances 10 to 100,000 ohms; diameter 7/8", depth 3/8", weight 1/2 ounce; standard linearity 2%.

Series AP1 1/8 — 4 watts continuous at 80°C; resistances 10 to 150,000 ohms; diameter 1 1/8", depth 1/2", weight less than 3/4 ounce; standard linearity 1%.

Waters has advanced facilities for the design and manufacture of miniature toroidal potentiometers and windings for use in equipment of special design.

Write today for complete information on all Waters potentiometers.

Waters
 MANUFACTURING, inc.

APPLICATION ENGINEERING OFFICES
 IN PRINCIPAL CITIES

Wayland, Massachusetts
 P. O. Box 368, So. Sudbury, Mass.

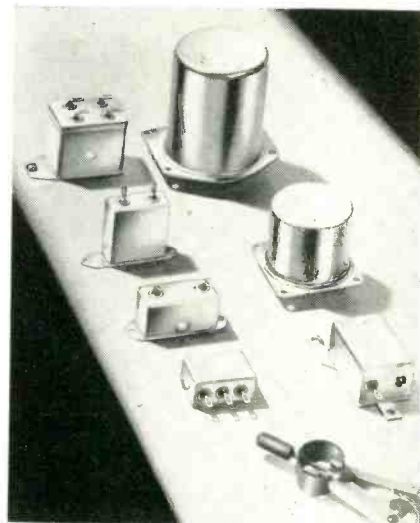

a 2 1/2-oz capacitor which, at triple the voltage, has twice the capacitance of a conventional 10-oz capacitor. Use of Mylar dielectric and a special conductor permits these reductions in filter and capacitor size and weight while maintaining or increasing capacitance and dielectric strength. Vacuum impregnated with polyamide resin and hermetically sealed in drawn steel cans, these r-f filters and starting capacitors have excellent resistance to vibration, fungus, salt spray and humidity. They retain their properties throughout the temperature range -65 to +300 F. Circle P92 inside back cover.



ALIGNMENT INSTRUMENT
 for the 10 to 145 mc range

KAY ELECTRIC Co., 14 Maple Ave., Pine Brook, N. J. The Radaligner model V is a complete alignment instrument designed for the 10 to 145 mc range. It includes a sweeping oscillator, calibrated variable-frequency marker and fixed crystal-controlled markers.

The new fundamental-frequency sweeping oscillator is continuously variable in six overlapping bands ac-

*Used throughout
the U.S.A. —*

(AND THE REST OF THE WORLD)

FOR ACCURATE MEASUREMENT OF L, C & R

UNIVERSAL BRIDGE Type 868/1

Inductance from 1 μ H to 100 H, Capacitance from 1 μ F to 100 μ F, and Resistance from 0.1 Ω to 10 M Ω . Single direct-reading LCR dial — no multiplying factors involved. Continuously variable a.c. bridge voltage and automatic detector sensitivity control.

L
at 1 or
10 kc

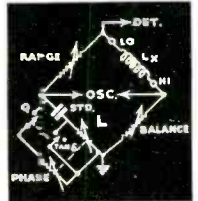

C
at 1 or
10 kc

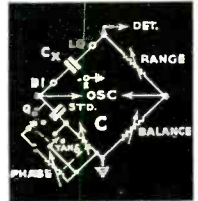

R
at d.c.

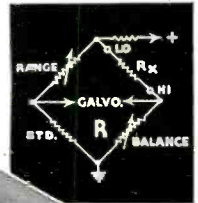

**MARCONI
INSTRUMENTS**

**IRE SHOW
BOOTHS 3315-17**

Marconi—since 1897

44 NEW STREET · NEW YORK 4

CANADIAN MARCONI COMPANY,
6035, COTE DE LIESSE,
MONTREAL 9, CANADA.

HEAD OFFICE: MARCONI INSTRUMENTS LTD · ST. ALBANS · HERTS · ENGLAND

Grid-Controlled Indicator Tube Monitors Transistor Circuits



KP-125,
Actual Size

The KP-125 is a subminiature, grid-controlled indicator tube which operates with small signal voltages and negligible current. A gas-filled triode of the glow-discharge type, the KP-125 provides a visual glow which may be viewed end-on or from the side. Both the filament (very low drain hearing aid type) and the anode may be operated from the AC line and consume power in the milliwatts region. The tube glows with 0 volts on the grid and extinguishes with -3 volts on the grid. Flying leads are provided for direct soldering into circuits, such as on printed boards. The characteristics of the KP-125 make it useful in computer transistor circuits as an indicator of current conditions which does not load the circuit under test. Additionally it serves as an indicator for monitor service in remote control panels. *For details on this and other special purpose electron tubes, write:*

KIP ELECTRONICS CORPORATION

Dept. ME, Stamford, Connecticut

VERY LARGE CAPACITY—HIGH VACUUM TWO-STAGE DUO-SEAL® VACUUM PUMP

TWO-STAGE CONSTRUCTION WITH
VENTED-EXHAUST PATENT PENDING

Eliminates Condensed Vapor Problems

- Eliminates oil filters and separators
- Reduces pumpdown time
- Fewer oil changes

GUARANTEED VACUUM
Vent closed, 0.1 micron.
When the vent is open, only slightly higher ultimate pressures result—usually in the range of 1 micron.

FREE AIR CAPACITY
375 Liters
Per Minute

Illustration shows
1397-B Duo-Seal
Pump equipped
with Vented Ex-
haust.

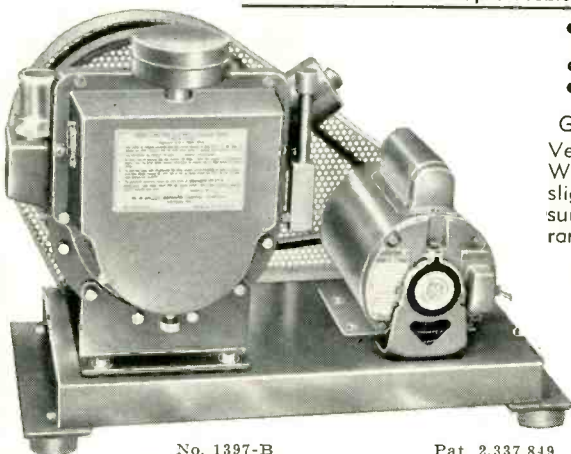

No. 1397-B

1397-B. DUO-SEAL VACUUM PUMP, Motor Driven. For 115 Volts, 60 Cycles A.C. Each, \$625.00

1397-C DUO-SEAL VACUUM PUMP, Motor Driven. For 230 Volts, 60 Cycles, A.C. Each, \$625.00

Pat. 2,337,849

1397-D. DUO-SEAL VACUUM PUMP, Motor Driven. For 115 Volts, D.C. Each, \$697.50

A belt guard is included with the mounted pumps.
1397. DUO-SEAL VACUUM PUMP, Un-mounted. With pulley, but without motor, belt or base. Each, \$525.00

W. M. WELCH SCIENTIFIC COMPANY

DIVISION OF W. M. WELCH MANUFACTURING COMPANY

ESTABLISHED 1880

1515 Sedgwick Street, Dept. H, Chicago 10, Illinois, U. S. A.

curately calibrated on a direct-reading dial. Sweep widths are provided variable to 60 percent of center frequency below 50 mc, 30 mc above 50 mc. The r-f output voltage is 1.0 v rms into 70 ohms, age'd for ± 0.5 db flatness over widest sweep and tuning range.

The variable marker is a birdie pip marker generated by a separate c-w oscillator continuously variable from 5 to 170 mc in six overlapping bands and calibrated to ± 1 percent on a separate direct-reading dial.

Eleven individually - switched, crystal-controlled pulse-type markers at customer-specified frequencies are provided for both separate and simultaneous operation. Circle P93 inside back cover.

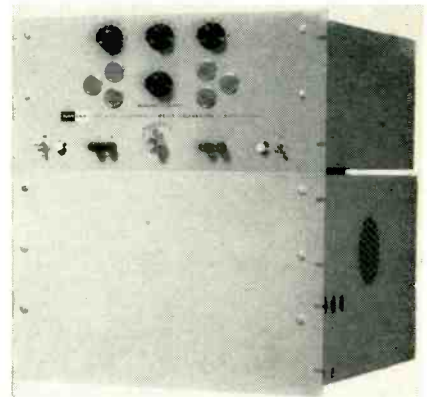

METER CALIBRATOR has many applications

KAY LAB, 5725 Kearny Villa Road, San Diego 11, Calif., announces a new improved model M100A-20 meter calibrator which provides d-c from 0 to 1,000 v at 0 to 200 ma with 0.01-percent long-time stability, 0.01-percent line and load regulation, 0.2-millisecond response time, 0.05-percent calibration tolerance, less than 2-mv hum and noise and less than 0.01-ohm output impedance.

The instrument employs high gain chopper amplifiers to constantly compare the output voltage with an internal standard cell, providing high accuracy and stability regardless of line or load variations. Direct-reading calibrated dials permit instant selection of the desired output voltage. Outputs are provided for both regulated voltage and current. The

ENGINEERS...

Let's exchange resumes

NAME:

Douglas Aircraft Company, Inc.

POSITION:

World's largest manufacturer of aircraft and missile systems.

LOCATIONS:

Santa Monica, El Segundo and Long Beach, California; Tulsa, Oklahoma; Charlotte, North Carolina.

AGE:

37 years in aircraft; 15 in missiles.

EDUCATION:

An engineering company managed by engineers — such as Donald W. Douglas, B.S., Aeronautical Engineering (M.I.T.); F. W. Conant, B.S., Civil Engineering (Cornell); and A. E. Raymond, B.S., Mechanical Engineering (Harvard), M.S., Aeronautical Engineering (M.I.T.), and Ph.D. (Hon.) (Polytechnic Institute of Brooklyn) — and with key staff positions held by graduate engineers, physicists and mathematicians, many with advanced degrees.

EXPERIENCE:

Holder of many "firsts," such as — first airplane to carry a pay load equivalent to its own weight. (1920) — first globe-circling airplane. (1924)

Builder of the famous "DC" series of commercial aircraft.

— every six seconds of each day, a Douglas commercial airplane takes off or lands somewhere in the world.
— currently producing the ocean-spanning DC-7C.
— soon to be in service, the exciting jet-powered DC-8.

Builders of nearly one-sixth of the planes produced in America during World War II.

Currently building even finer transports, jet fighters and bombers.
Pioneer in missile research and production with nine separate projects.

REFERENCES:

Every major airline in the world.
Thousands of manufacturers of components for aircraft and missiles.
The U.S. Army, Navy and Air Force.
Some 80,000 Douglas employees throughout the country.

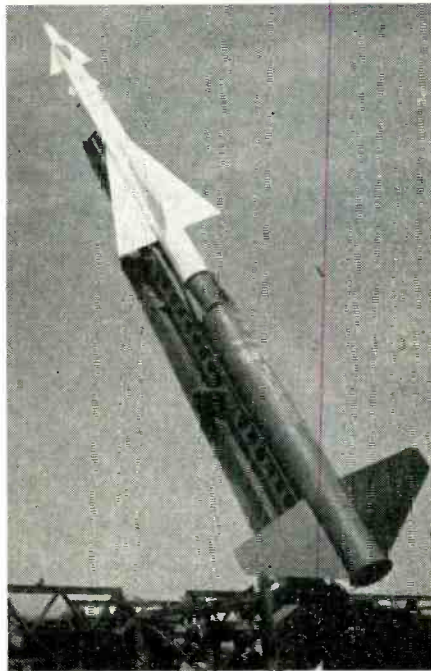

NIKE I, a radar-guided missile, intercepts bombers at supersonic speeds despite evasive action.

Engineers modify DC-8 configuration in wind tunnel tests for stability and control data.

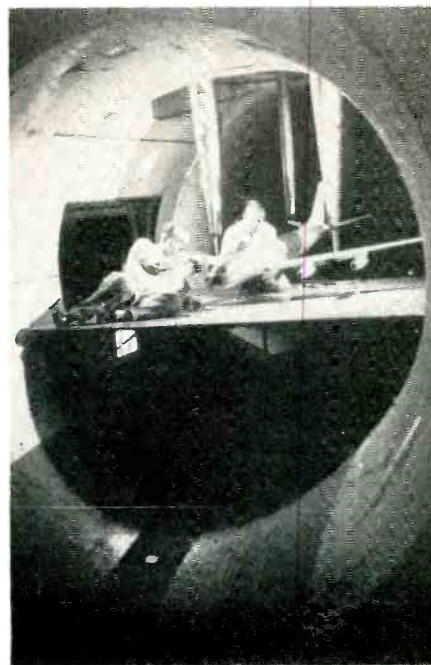

NAME:

POSITION:

ADDRESS:

AGE:

EDUCATION:

EXPERIENCE:

REFERENCES:

**FILL IN THE ABOVE INFORMATION
TEAR OUT AND SEND TO**

C. C. LaVENE
DOUGLAS AIRCRAFT COMPANY
BOX F-620
SANTA MONICA, CALIFORNIA

GO FURTHER WITH

DOUGLAS



FIRST IN AVIATION



New

UNION

Digital Indicator

**combines data readout
and storage facilities**

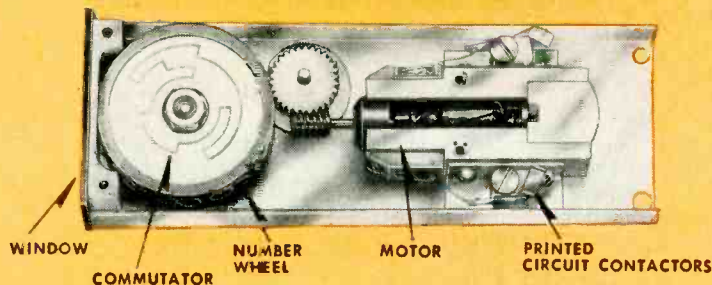
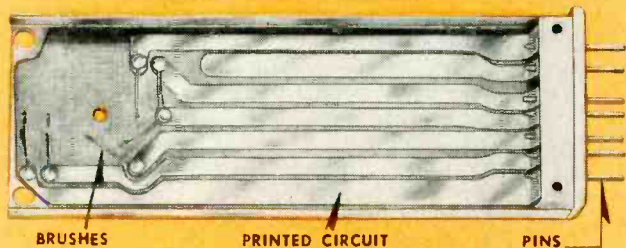

Physical characteristics: Over-all length... $5\frac{1}{8}$ " , width... $1\frac{1}{32}$ " , height... $1\frac{1}{4}$ " , weight... 7 oz., operating time at 24 volts... 0.8 sec., life expectancy... 1,000,000 operations. Character size... $\frac{3}{8}$ " x $\frac{1}{4}$ " .

The new UNION Digital Indicator will satisfy most requirements for data display, either local or remote. It is a companion product to our Alpha-Numerical Data Display Indicator, but occupies only one-half the volume and requires under three watts power.

The ability of the indicator to operate as a storage facility, a readout device, and its inherent non-dissipating storage give it characteristics not to be found in any other indicator of this type.

The indicator is motor-driven and operates on a direct wire basis in response to binary code. The coded

decimal notation was chosen for prototype to demonstrate more familiar uses, but other notations can be used.

A typical application in a pipeline remote control system works like this: Telemetered digital data on temperature and pressure is received at a central station and entered into an intermediate storage. From there it is routed to the appropriate digital indicators for visual display and electrical storage for time programmed input to a telelog printer. Each indicator can store four binary bits and eliminates the use of relays for this purpose. Write for our new Bulletin 1011.

See our exhibit at the I.R.E. Show, Mar. 18-21, Booths 2122-2124.

GENERAL APPARATUS SALES

UNION SWITCH & SIGNAL

DIVISION OF WESTINGHOUSE AIR BRAKE COMPANY

PITTSBURGH 18, PENNSYLVANIA

NEW PRODUCTS

(continued)

M100A-20 is ideal for laboratory and production meter calibration, standards laboratories computer facilities, nuclear research and many other applications. Circle P94 inside back cover.

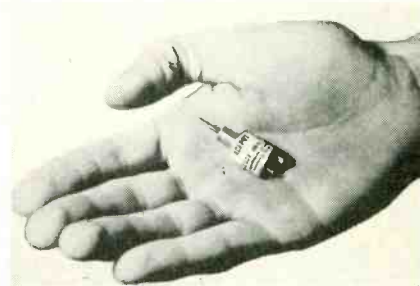

SUBMINIATURE POTS
rated to 250,000 ohms

ACE ELECTRONICS ASSOCIATES, INC., 103 Dover St., Somerville 44, Mass., announces new Acepots with resistance range from 10 ohms to 250 K and the extremely fine linearity of ± 0.3 percent. They measure only $\frac{1}{2}$ in. by $\frac{1}{2}$ in.

► Other Specifications—Weight is $\frac{1}{4}$ oz; power, two w for 60 C rise; ambient temperature, -55 C to 150 C. The potentiometers are available in standard threaded bushing, servo or flush mountings, and ganged units. All units are fully sealed, moisture-proofed, and antifungus treated. They meet applicable portions of JAN specifications and MIL-E-5272A standards. Circle P95 inside back cover.

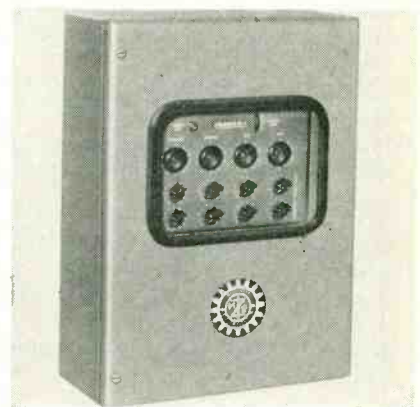

PRESET COUNTER
for industrial applications

MACHINERY ELECTRIFICATION, INC., Northboro, Mass. The MEK-2094-AG electronic counter was de-

signed for all industrial counting applications and will count from 0 to 5,000 counts per sec without special adjustment or circuit changes. The counter will operate with photoelectric, semiconductor, magnetic or contact making pickups. At the end of the warning and final count, plug-in relays are energized for control purposes. After reaching the end of count the counter can be reset to zero.

Operating personnel will be interested in the enclosure design which provides visible observation without opening the dust-tight, oil-tight (NEMA 12) enclosure. When a change in setting is required, the enclosure can be opened by nonelectrical personnel as the unit is dead front (NEMA 1) with the door open.

Features, specifications and general information are presented in a looseleaf catalog section and price list. Application data and diagrams are shown with photographs of the various forms available. Circle P96 inside back cover.



STORAGE SCOPE available in two models

HUGHES PRODUCTS, International Airport Station, Los Angeles 45, Calif. Model 103 Memo-Scope incorporates the Memotron Ray storage tube. The instrument combines the unique quality of information persistence with all the features of a superior quality laboratory oscilloscope. It captures and retains any number of traces indefinitely at a constant intensity until intentionally erased. Traces are readily visible in a brightly lighted laboratory and may be easily photographed. The scope is available in two

UNION

UNION Miniature Relay, actual size.

HIGH LOADS and LOW LOADS can be handled at the same time and with consistent reliability by one UNION Miniature Relay with HI-LO contacts. (Photo enlarged 2½ times.)

New HI-LO Contacts make one UNION Relay do two jobs!

Now you can use *one* UNION Miniature Relay for both high-level and low-level circuits. A new contact material handles high loads of two amperes or low dry-circuitry loads with consistent reliability. Formerly, two separate relays were required for these applications.

The new HI-LO contact material provides optimum contact resistance for both high-level and low-level

loads. This means you can frequently save the cost of buying two different types of relays . . . and inventory expenses are much less.

You can get all standard UNION 6-pole and 4-pole Miniature Relays with HI-LO contacts. They meet or exceed specification Mil-5757-C and are available in DC or AC models. Write for Bulletin 1012 on UNION Miniature Relays.

See our exhibit at the I.R.E. Show,
March 18-21, Booths 2122-2124

GENERAL APPARATUS SALES
UNION SWITCH & SIGNAL
DIVISION OF WESTINGHOUSE AIR BRAKE COMPANY

PITTSBURGH 18, PENNSYLVANIA

From LFE's special
products division . . .

Visit us at the
I.R.E. Show
Booths 3207, 3209

**... Model 814 Ultra-Stable
Microwave Oscillator**
**Why buy STABILITY in a
microwave oscillator?**



When you get a built-in automatic stabilization indicator you can take advantage of the inherent accuracy of a stabilized frequency generator. LFE's Model 814 Ultra-Stable Microwave Oscillator has this feature. Combined with a direct reading dial this signal source provides short term stability to 5 parts in 10^8 as easy to use as a voltmeter. Semi-military construction; exceptional reliability. Ideal for research or production line testing.

Use LFE's X-Band Oscillator in many ways, for:

development work on radar sets	measuring Q of cavities
production line testing	research in nuclear resonance
standing-wave measurements	any microwave research requiring an X-band signal generator

Specifications

Frequency Range 8500 to 10,000 mc/s
Direct Reading Main dial calibrated 1 mc/division, linear vernier dial for interpolation
Power Output 80 mw nominal into 50-ohm load
Output Connector 40/U choke flange, 1/2 x 1-inch waveguide
Stability 5 parts in 10^8 short term; 1 part in 10^6 long term under usual environmental conditions
Automatic Stabilization Indicator Front panel lamp
Modulation Internal — 25% @ 1000 cps;
External — BNC jack on front panel
Mounting Louvered cabinet; removeable for rack mounting of instrument
Weight 100 pounds
Power Required 190 watts @ 117 volts, 50-60 cps
Also manufactured in S-band and in other bands on special order.

Look to LFE for progress in microwave instrumentation

For additional information on this or any LFE instrument, simply write today



Special Products Division
LABORATORY FOR ELECTRONICS, INC.
75 Pitts Street • Boston 14, Massachusetts
manufacturers of oscilloscopes, digital test instruments, decade scalars, delay lines, transformers, radar sets, business machines and other types of complex electronic equipment.

NEW PRODUCTS

(continued)

models: portable (13 in. wide, 14 in. high, 20 in. deep) and rack mounted (14 in. by 19 in.). Circle P97 inside back cover.

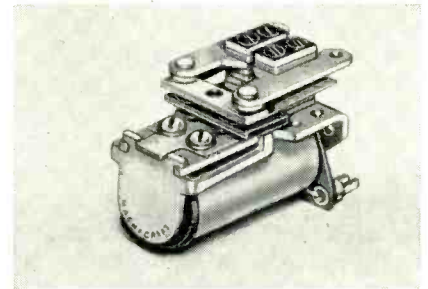

**SMALL RELAY
switches heavy current**

MAGNECRAFT ELECTRIC Co., 3350 W. Grande Ave., Chicago 51, Ill. Reliable switching of heavy current in limited space through long service life is achieved by a new class 22D telephone type relay. A unique feature is specially designed double break contacts that switch up to 20 amperes, noninductive load. Contacts are spst, normally open. Overall dimensions are 2 7/8 in. long, 1 3/8 in. high, 1 1/8 in. wide. It is available for operating voltages to 230 d-c and 440 v, 60 cycle, a-c. Circle P98 inside back cover.

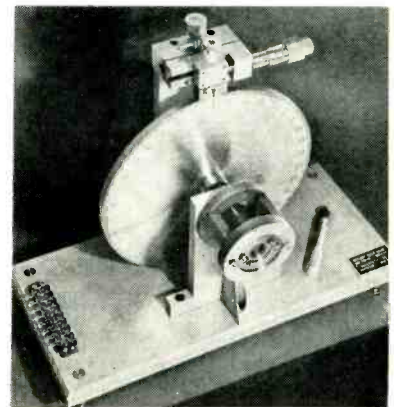

**ROTARY TEST HEAD
for shaft position indexing**

MILLITEST Co., 88 Madison Ave., Hempstead, L. I., N. Y., has added to its line of component test instruments, the rotary test head, designed to permit rapid and accurate indexing of shaft position on rotary components such as potentiometers, resolvers, synchros and the like.

This fixture consists of a pre-

cision gear fixed to a shaft and chuck. The wheel can be positioned in half-degree steps through a rack engagement. A micrometer advance on the rack mechanism permits fine phasing to within one-half minute. The repeatability of settings is to within one part in 200,000.

The test fixture is supplied with a case-holding nest carrying pilot diameters for standard potentiometers. Adapters of various types to accommodate special components are available. Circle P99 inside back cover.

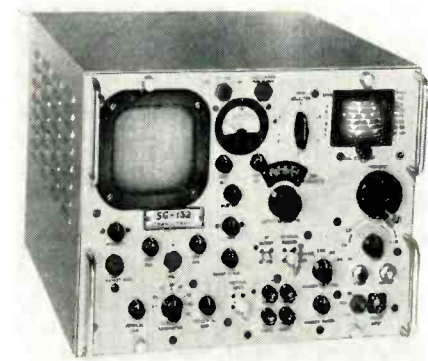

SWEEP GENERATOR for vhf-uhf operation

TRANSITRON, INC., 186 Granite St., Manchester, N. H. Model SG-132 combines all the essential features of a standard c-w and a-m signal generator and a wide-band sweep generator. Among its many applications are testing and aligning vhf-uhf communication receivers, measuring sensitivity, selectivity, image rejection and gain of receivers, i-f amplifiers, broadband amplifiers, tv and other equipment. It offers a wide sweep width—40 percent of the center frequency, from 15 to 400 mc, with a dial accuracy of 0.1 percent, crystal corrected.

The output, which is entirely fundamental (not beat-frequencies), is calibrated from 0.1 to 150,000 μv throughout the frequency range. An unusual feature is the constancy of this output which varies less than ± 0.2 db over the entire range. The equipment also has an integral d-c coupled oscilloscope. Circle P100 inside back cover.

Visit us at the
I.R.E. Show
Booths 3207, 3209

New from LFE's special
products division...

... microwave stability tester
can you measure
microwave oscillator
stability to 1½ CPS?



MODEL 5004

The *only* instrument on the market capable of measuring frequency deviation and rate, drift and rate of drift with the accuracy required to check MTI Radar Stable Local Oscillators! Read peak deviation as small as 1½ cps at 3 kmc, 6 cps at 6 kmc and 10 cps at 10 kmc.

One meter reads drift, one reads peak deviation. By means of a standard oscilloscope, all disturbing FM below 5 kc can be displayed. Effect of making circuit changes is immediately apparent.

Please note! Deviation readings are completely independent of the drift component.

Features

- Exceptional Accuracy
- Direct-Reading of FM Deviation
- Semi-Military Construction
- Direct-Reading of Drift
- Disturbing Frequencies Displayed
(by means of standard oscilloscope)
- Measures Rate of Drift
- Instrument Stability
1 part in 10^{11}
- Reliability

Frequency Ranges

- 30 to 230 kc and 30 mc
- 1 to 3 kmc/s*
- 5.1 to 6.1 kmc/s*
- 7 to 10 kmc/s*
- 9.6 to 10.8 kmc/s*
- * Plug-in heads

Applications

- Design and testing of MTI circuits
- Design and testing of local oscillators or coherent oscillators
- Checking magnetron performance
- Locating disturbing frequencies in microwave signal equipment

A custom-built instrument for the most exacting laboratory and manufacturing use.
For detailed specifications, simply write

Special Products Division
LABORATORY FOR ELECTRONICS, INC.
75 Pitts Street • Boston 14, Massachusetts

manufacturers of oscilloscopes, digital test instruments, decade scalars, delay lines, transformers, radar sets, business machines and other types of complex electronic equipment.



New Literature



Beckman Servomotor- Rate Generator

Snug as two bugs in their unitized stainless steel housing, motor and generator work hand-in-hand on the same shaft... to improve response characteristics of suffering servo systems.

Where the trouble is in the dynamics of your system components, watch this purposeful pair roll up their sleeves and go to work. The high torque-to-inertia motor, for instance, responds quickly and accurately to error signals... with acceleration at stall up to 100,000 radians/sec.². Signal-to-noise ratio of the linear generator is 25:1 or better. Aiding and abetting each other in their dedicated mission, they'll operate continuously at stall and at total unit temperature from -55°C to 200°C.

Right now, our corrosion-resistant, completely encapsulated Servomotor-Rate Generators are available in sizes 11, 15 and 18. (We'll soon add size 8; eventually, other sizes.) We've got descriptive literature available too. It's data file 331.

Beckman® Helipot

Corporation

Newport Beach, California

a division of Beckman Instruments, Inc.

Engineering representatives

in principal cities

956

Digital Computer. Bendix Computer Div., Bendix Aviation Corp., 5630 Arbor Vitae St., Los Angeles 45, Calif. A six-page illustrated bulletin describing the G-15D general-purpose digital computer and its digital differential analyzer accessory, is now available. With the two units discussed, linear and nonlinear differential equations are solved accurately and rapidly. New programming techniques and a complete new line of input and output equipment are also described. **Circle L1 inside back cover.**

Facilities Brochure. Neutronics Research Co., 165 Lake St., Waltham, Mass., has published a prospectus showing the company background and indicating its availability for R & D contracts and subcontracts in the fields of countermeasures, communications, medical electronics, educational devices, instrumentation and control circuits. **Circle L2 inside back cover.**

Instrumentation Tape Recorder. Ampex Corp., 934 Charter St., Redwood City, Calif. Capabilities and characteristics of the FR100 instrumentation tape recorder are described in an attractive 20-page booklet. Detailed specifications are also provided in the four-color booklet.

Numerous illustrations show transports, heads and modular electronic assemblies used with the FR100. Where necessary, graphs are provided to clarify specifications and recorder operation.

The recorders discussed are used in data acquisition, storage, analysis and reduction, in machine and process programming and in dynamic simulation. Data may be recorded and reproduced in the d-c to 100-kc frequency range on one to 14 tracks at any of six standard tape speeds, 1 $\frac{1}{8}$ to 60 ips. **Circle L3 inside back cover.**

H-F Resistors. International Resistance Co., 401 North Broad St., Philadelphia 8, Pa. Catalog data

bulletin F-1a covers types MP and HFR high-frequency and miniature high-frequency resistors. Comprehensive data on construction, characteristics, applications, types, resistance values, tolerances, terminals and installation are detailed in charts and graphs. The eight-page bulletin is available on request. **Circle L4 inside back cover.**

Dynograph Recorders. Offner Electronics Inc., 5320 North Kedzie Ave., Chicago 25, Ill., has issued a 12-page, two-color catalog describing the new Dynograph recorder models. The Dynograph, a high-speed direct-writing oscillograph for the recording of a variety of dynamic and static variables, combines in one unit, three media of recording: ink, heat sensitive, or electric sensitive with either curvilinear or rectilinear coordinates.

Described in detail are the principles of operation, specifications, assemblies and construction of the four models—console, computer console, rack mounted and portable.

A special selection chart shows the many features available in the various types of assemblies and the alternate mountings. For low-gain applications such as telemetering and computer write-out, specially designed simplified assemblies are supplied. **Circle L5 inside back cover.**

Test Equipment and Components. Northeastern Engineering, Inc., Manchester, N. H., has available a 24-page catalog of electronic test equipment and components. It contains illustrated descriptions and technical specifications for decade counters, a frequency meter, spectrum analyzer, electronic multimeter, f-m radio receiving set, electronic counter and a signal generator. **Circle L6 inside back cover.**

Precision Switch. Micro Switch, a Division of Minneapolis-Honeywell Regulator Co., Freeport, Ill. Preliminary data sheet 115 covers the 1RA1 subminiature screw-

driver-actuated switch. The switch described gives designers of computers, electrical devices and electronic equipment a switch that is handy where limited access is desired or when the switch is used only occasionally. Price, quantity discounts and electrical ratings are shown. Circle L7 inside back cover.

Micromicroammeters. Leeds & Northrup Co., 4907 Stenton Ave., Philadelphia 44, Pa. Two types of micromicroammeters for nuclear-reactor control systems are described in data sheet E-03(1).

One of the nuclear control system components discussed, with integral range switch and meter, is designed for control-panel mounting. The other utilizes a bidirectional Ledex mechanism and can be installed remotely from the panel.

Complete engineering features and ordering information for each model are listed. Circle L8 inside back cover.

Alloy Guide. Techalloy Co., Inc., Rahns, Pa. A new selector guide for high-temperature, heat-resisting alloys is now available. The chart gives vital data on comparative strengths at high temperatures, scaling resistance, individual characteristics and comparative prices. Alloys covered are Inconel, Inconel X, Incoloy, Techalloy 80 Ni 20 Cr, stainless and heat-resisting steels—types 330, 310, 314, A-286 and N-155. Circle L9 inside back cover.

Microphone Calibration Apparatus. Brush Electronics Co., 3405 Perkins Ave., Cleveland 14, Ohio. The new microphone calibration apparatus, model BL-4119, is illustrated and described in a new catalog sheet. The apparatus discussed enables both a calibration procedure which is a simplified form of the standardized reciprocity calibration technique in accordance with the ASA standard Z24.4, and the determination of the complete frequency-response curve of the microphone with the aid of an electrostatic actuator.

The free literature contains de-

From DIALCO—New, Compact

OIL TIGHT INDICATOR LIGHTS

for heavy duty industrial applications

OIL TIGHT DUST TIGHT OMNIDIRECTIONAL

Exceptionally Rugged!

Perfect oil-tightness is effected by retained oil-proof gaskets and the gasketed glass lens assembly.

These units have many heavy-duty features: *One-piece solid brass bushing, solid brass lens holder, high impact phenolic insulation, rugged binding screw terminals.*

They install easily in a single 1" or 1 3/16" panel mounting hole. Other units available for 1 1/16" mounting hole. *A choice of 3 lens styles, 7 lens colors, and other optional features provide adaptability. If you have an unusual problem, consult our engineering department.*

DISCS with legends, behind flat lenses, deliver specific messages.

DIALCO

OIL TIGHT INDICATOR LIGHTS

accommodate a wide range of Incandescent and Neon Glow Lamps. For neon, DIALCO offers an exclusive feature — **BUILT-IN RESISTORS** (U. S. Patent No. 2,421,321) for operation on 105-125 V, or 210-250 V. Simple external resistors are provided for all higher voltages. **EVERY ASSEMBLY IS AVAILABLE COMPLETE WITH LAMP.** For design purposes we will send :

SAMPLES ON REQUEST—AT ONCE—NO CHARGE

CATALOG "L-200" gives you complete specs on DIALCO'S Oil-Tight Indicator Lights. Also available—a file of Special Catalogs on DIALCO Pilot Lights covering every indication requirement.

FREE — Brochure on "Selection and Application of Pilot Lights".

Foremost
Manufacturer
of Pilot Lights



DIALIGHT
CORPORATION

58 STEWART AVENUE
BROOKLYN 37, N. Y.
HYACINTH 7-7600



No. 103-3502-1331



No. 103-3502-1211



No. 104-3502-XP10-231

Illustrations are approx. actual size



DIALIGHT CORP., 58 Stewart Ave., Brooklyn 37, N. Y.

- Please send Cat. "L-200" on Oil-Tight Lights
- "Selection" Brochure. Pilot Light Catalogs.

Name _____

Company _____

Address _____

City _____ State _____

FANSTEEL

DEPENDABLE

Tantalum Capacitors

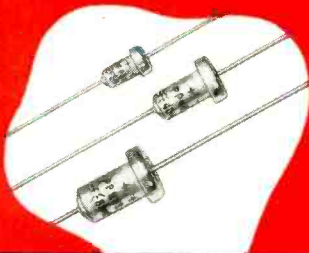

Series VP, for excessive vibration or shock requirements

Series PP, for normal temperature ranges

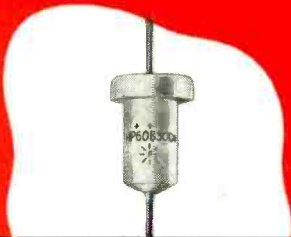
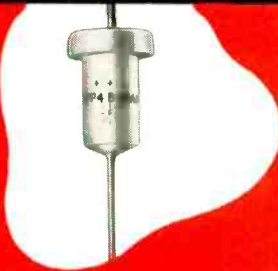

Series HP, for high ambient temperatures (to 125°C) and for vibration resistance

Series PP, VP and HP are also available with insulated cases.



STA Solid Tantalum. Voltage ranges up to 30 volts, D-C. Unusual stability over a wide temperature range



Hermetically sealed capacitors to special order

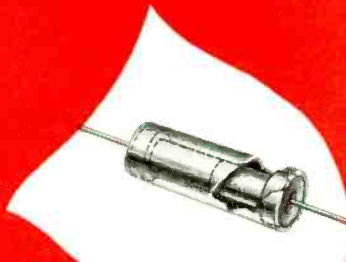

Special configurations to your order

CHECK
BOOTH 4021
AT THE I.R.E. SHOW

FANSTEEL METALLURGICAL CORPORATION

North Chicago, Illinois, U.S.A.



TANTALUM CAPACITORS...DEPENDABLE SINCE 1930

NEW LITERATURE

(continued)

tailed design, operating and installation information which suggests various application opportunities. One side of the sheet covers detailed specifications of the instrument. **Circle L10 inside back cover.**

Autopilot Control. Minneapolis-Honeywell Aeronautical Div., 2600 Ridgeway Road, Minneapolis 13, Minn., has published a six-page pamphlet that describes in detail its MB-3 automatic flight control system for supersonic aircraft. More than two dozen of the principal components of the system are described and pictured in a cutaway of the plane that will use the system. The MB-3 discussed weighs just 98 lb, yet has more than 5,000 different individual parts. **Circle L11 inside back cover.**

Digital and Analog Systems. Mack Electronics, a division of Mack Trucks, Inc., 40 Leon St., Boston 15, Mass., has available data sheets covering a complete line of digital building blocks featuring magnetics and semiconductors. They deal with design and construction of digital and analog systems featuring latest technological developments, stringent environmental capabilities, reliability, compactness and low power. Electrical characteristics and mechanical data are included. **Circle L12 inside back cover.**

New Alnico. Thomas & Skinner, Inc., 1120 E. 23rd St., Indianapolis, Ind. Bulletin DMF-3 gives a description of Alnico 5Cb, including its physical properties, dimensional limitations and a typical demagnetization and energy product curve. It also contains a description of the comparative properties of all of the company's standard permanent magnet materials. **Circle L13 inside back cover.**

TV Transmitter Specifications. Standard Electronics Corp., 285 Emmet St., Newark 5, N. J. Two new tv transmitter specifications bulletins describe the S-E 500 watt and 10-kw vhf tv transmitters (high and low band). The

bulletins contain photographs of the transmitters, complete explanations of how the equipments operate, descriptions and illustrations of major design features, electrical and mechanical specifications, tube lists and block diagrams of both aural and visual transmitters. Circle L14 inside back cover.

Silicon Junction Diodes. Hughes Products, A Division of the Hughes Aircraft Co., International Airport Station, Los Angeles 45, Calif., has published new data sheets covering eight types of its standard silicon-junction diodes. They contain the latest information concerning the design, characteristics and specifications of these diodes, which have sharp back-voltage breakdown and evidence extremely low saturation current throughout wide temperature ranges. Circle L15 inside back cover.

Enamel and Magnet Wires. General Cable Corp., 420 Lexington Ave., New York 17, N. Y., has published a small reference handbook and guide to the currently available coatings and magnet wires which helps to eliminate the confusion resulting from the great increase in the types of wires available and also in the number of trade names used by the different manufacturers.

The guide lists the basic types with their main advantages and disadvantages and, in addition, gives the trade names and manufacturers under each type. Wires are classified in 10 groups: oleo-resinous enamel, Formvar, self-bonding Formvar, nylon, Formvar nylon combinations, polyurethane, class B film insulated, class H film insulated, special types and magnet wires. Circle L16 inside back cover.

Glass Products. Croname Inc., 3701 Ravenswood Ave., Chicago 13, Ill., has issued a new bulletin on glass entitled "New Dimensions In Product Design With Decorative Glass." The brochure discusses the properties of glass and the characteristics of glass which make it a versatile material

FANSTEEL

Dependable Rectifiers



Silicon Rectifiers



Selenium Milli-Rectifiers

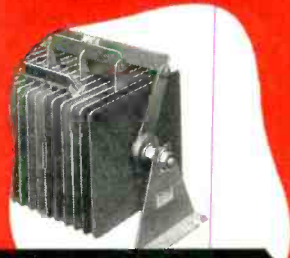

Selenium Industrial Power Rectifiers

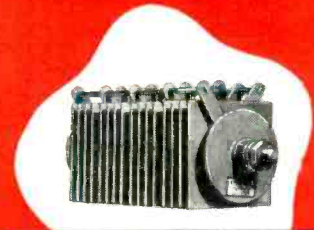

Selenium High Temperature Power Rectifiers (to 150°C)

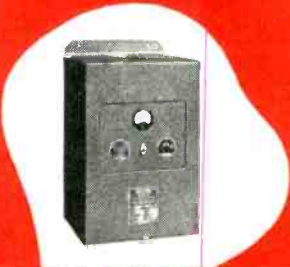

Battery Chargers and Power Supply Units



Special Hermetically Sealed Units to Special Order

CHECK
BOOTH 4021
AT THE I.R.E. SHOW



E573A

FANSTEEL METALLURGICAL CORPORATION

North Chicago, Illinois, U. S. A.

DEPENDABLE RECTIFIERS SINCE 1924

BIRD Termline 50 Ohm Coaxial Line Load Resistor



1200
Watts
Continuous
Duty
1500 Watts
Intermittent Duty
2 to 3 KW
Continuous Duty with
forced air cooling
Input connections are
available to terminate
most coaxial lines.

Visit us at the IRE Show —

Booth # 3215 and # 3217.

SERIES 88

As a reflection-free termination for rigid or flexible 50 ohm transmission line, the rugged and lightweight Series 88 "Termline" Load Resistor is recommended for use during adjustment, testing and alignment of transmitters operating in frequency range up to 3300 mc.

It may also be used to terminate a line when power is being measured by a Bird "ThruLine" Directional Wattmeter. Standard VSWR specification is 1.1 to 1 maximum, controlled by tests from 0 to 1000 mc.

Phone or write on other VSWR requirements.

Series 88 "Termline" Load Resistor data sheet # R-886 and "ThruLine" Directional Wattmeter data sheet # 406 also available for immediate delivery.



"ThruLine"
Directional
RF Wattmeters



"Termline"
RF Absorption
Wattmeters



Coaxial
RF Filters



Coaxial
RF Switches



BIRD ELECTRONIC CORP.
Express 1-3535
1800 E. 38 St., Cleveland 14, Ohio

Western Representative: VAN GROSS COMPANY • Sherman Oaks, California

CHURCHILL CASES

To House Electronic Equipment
SPECIFICATION MIL-C-172B

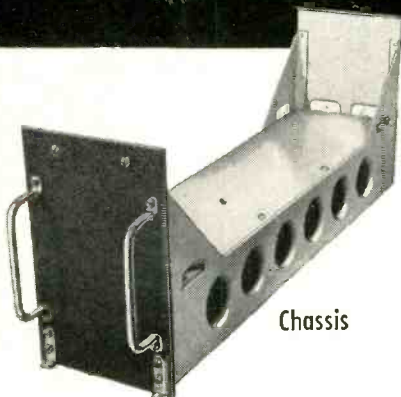

Chassis



Dust Cover

An accurately engineered quality product.
All standard sizes carried in stock.

For further information write for Datalog #1
and the name of Sales Representative nearest you.

Churchill Lighting Corp.

344 FRANKLIN ST. ME 4-4700 MELROSE, MASS.



for producing glass products for radios, television, electronic cabinets, control panels and the like. Circle L17 inside back cover.

Epoxy Glass Cloth. Standard Insulation Co., East Rutherford, N. J. Technical data, suggested curing cycles and samples of Stanpreg flame-resistant epoxy resin preimpregnated glass cloth are available. The material described is being used in laminates exhibiting such electrical characteristics as 83,000,000 megohm-centimeters volume resistivity, 25,000,000-megohms surface resistance, and 18,000,000-megohms insulation resistance. It has been engineered primarily for critical electrical and electronic laminates as in printed circuits. Circle L18 inside back cover.

Data Recording Cameras. Flight Research, Inc., P. O. Box 1-F, Richmond 1, Va. Multidata cameras, the multiple-purpose precision data recording cameras, are the subject of an eight-page illustrated brochure. Small and lightweight, the Multidata cameras permit automatic synchronized motion picture or single-frame operation. The brochure shows how the cameras have eliminated hundreds of hours in such diversified applications as airborne systems analysis, missile tracking, radar evaluation, stereoscopic recording and automatic systems evaluation. Circle L19 inside back cover.

Galvanometers. Consolidated Electrodynamics Corp., 300 North Sierra Madre Villa, Pasadena, Calif. Bulletin 1528 covers the series 7-300 galvanometers. It outlines uses, principle of operation, construction features, galvanometer characteristics and application circuitry. Information on accessories is also given. Circle L20 inside back cover.

Magnetic Shift Registers. Magnetics Research Co., 255 Grove St., White Plains, N. Y., has issued technical bulletin No. 128 concerning the production of miniature magnetic shift registers of eight bits each—models MSR-1 and MSR-0—which can be used together to form a small 16-bit

shift register for serial read-in and read-out. The units discussed can be used in many military applications as well as in radar, computer and business-machine systems. **Circle L21 inside back cover.**

Insulating Materials. Insulation Manufacturers Corp., 565 W. Washington Blvd., Chicago 6, Ill. Catalog 20 is an illustrated, completely indexed 32-page booklet on electrical insulations for repair and maintenance of motors, generators and electrical or electronic equipment. The catalog contains descriptions, photos, prices and ordering data. **Circle L22 inside back cover.**

Long-Life Soldering Tips. Hexacon Electric Co., 130 W. Clay Ave., Roselle Park, N. J., announces a new catalog (No. 144), showing a greatly expanded line of Hexclad long-life soldering tips. There are 40 stock sizes and shapes and many special styles to choose from.

The various shapes of plug and screw tips are illustrated and in the catalog data the tip diameter and length, style of tip point and size of tip point are given. Also indicated are the various soldering iron models each tip fits. Instructions on use and care of the tips are included. **Circle L23 inside back cover.**

Silicon Rectifiers. Sarkes Tarzian, Inc., 415 N. College Ave., Bloomington, Ind., has published a series of design notes on a wide variety of silicon rectifiers. Each of the catalog sheets shows features, electrical ratings, characteristics and output voltages. **Circle L24 inside back cover.**

Automatic Exposure Control. Flight Research, Inc., P. O. Box 1-F, Richmond 1, Va. AUTEX, a versatile electronic device for the automatic control of exposure in motion pictures, is described in an illustrated brochure. Designed to adapt to any motion picture camera and to be used with many lenses, AUTEX is a new tool for the professional, industrial and scientific photographer contend-

FOR DATA PROCESSING COMPONENTS AND SYSTEMS

SPECIFY POTTER

Potter instruments and systems are unexcelled in reliability, accuracy and flexibility.

The equipment shown is typical of many more available as individual components or in integrated systems to meet specific requirements.

Write for brochure describing these and other Potter units, including special products. For detailed technical specifications on any of the Potter Products listed above, contact your Potter Representative or the factory.

DATA-HANDLING EQUIPMENT



Digital Magnetic Tape Handlers

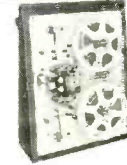

Perforated Tape Readers

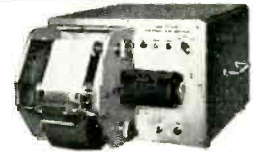

"Quick Look" Recorders

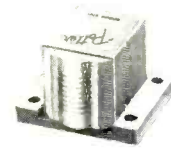

Record-Playback Head Assemblies



Record-Playback Amplifiers

PRESET INTERVAL GENERATORS



Preset Interval and Delay Generators

HIGH SPEED ACCESS REGISTERS



Ten-Bit Parallel Output (Serial Input) Using Magnistors



Ten-Bit Serial Output (Parallel Input) Using Magnistors



Six-Bit Digital Comparator Using Magnistors



POTTER INSTRUMENT COMPANY, INC.

115 Cutter Mill Road

Great Neck, L. I., N. Y.

Visit Us at the IRE Show Booths 1912-14

Let **ERIE** DO IT

FOR YOU WITH

PAC

FROM OUR
ASSEMBLY
LINE TO
YOURS

*
**Pre-
Assembled
Components...**

a new concept in
UNITIZED packaging

PAC reduces costs! PAC (Pre-Assembled Components) simplifies complex automation assembly lines by eliminating many of the insertion heads required for individual components. PAC groups capacitors and resistors into a unitized modular package for quick installation in a printed circuit board.

PAC (Pre-Assembled Components) not only reduces the number of insertions and eliminates insertion equipment; it also means fewer items to purchase, smaller chassis area, fewer chassis holes, and reduced inspection. ERIE has complete facilities for designing PAC into your circuits, and for manufacturing these modules efficiently on high speed equipment.

Manufacturers are saving money and producing more compact and attractive radios, TVs and other electronic products through the use of custom built PACs. Write for Engineering Bulletin 450-1.

Experimental PAC Design Kits are offered for sale in three models, with standard 5-10-20% values and tolerances, enabling engineers to make up their own breadboard designs. The PAC Design Kit is your key to cost savings. Write for full description and prices.

ing with uncontrollable light conditions. The brochure describes the Accent Control feature of AUTEX, that permits the photographer to deliberately change the aperture setting from the correct value for the average lighting of the scene, to produce the best exposure for the object of chief interest. An advanced transistorized circuit permits response speeds that provide full travel from f/2 to f/22 in as little as one second. The brochure includes specifications. Circle L25 inside back cover.

Universal Potentiometer. Leeds & Northrup Co., 4934 Stenton Ave., Philadelphia 44, Pa. A new six-page data sheet E-51(6) describes the type K-3 universal (guarded) potentiometer. It lists complete specifications of the instrument and gives typical applications in laboratories. A full-page illustration of the type K-3 is shown as well as components such as slide-wires, switches and binding posts. A complete description of the circuit operation including schematic diagrams is included. The uses of the auxiliary potentiometer are discussed and recommended accessories and ordering instructions are given. Circle L26 inside back cover.

Radio and TV Components. N. V. Philips Gloeilampenfabrieken, Eindhoven, Holland, has published a radio and tv components handbook. This is a loose-leaf publication containing characteristics of variable, electrolytic and trimming capacitors, several kinds of loudspeakers, output-transformers, h-f coils, a-m and f-m permeability tuners and tv components.

The handbook can be kept up-to-date by the issue of supplementary sheets, published four or five times a year. Price of the handbook is \$3. Subscription to the supplementary sheets is \$1 per year. Circle L27 inside back cover.

Silicone-Resin Spray. Ed-Berl Products, Inc., 87 Merrick Rd., Baldwin, L. I., N. Y., has available descriptive literature on three of

ERIE ELECTRONICS DIVISION
ERIE RESISTOR CORPORATION
Main Offices and Factories: ERIE, PA.
Manufacturing Subsidiaries
HOLLY SPRINGS, MISSISSIPPI • LONDON, ENGLAND • TRENTON, ONTARIO

its latest products—Silikone, Sil-Lube and stainless steel pin straightener sockets. Silikone, used as a moisture repellent on electronic components, eliminates h-v corona discharge. Sil-Lube cleans, lubricates and restores volume controls and gang switches. The seven and nine-prong miniature tube pin straightener socket is designed for panel and chassis mountings. Circle L28 inside back cover.

Molded Tubulars. General Electric Co., Schenectady 5, N. Y. An eight-page publication on molded PVZ tubular capacitors is now available. Designated GET-2671, the bulletin contains descriptive information and lists ratings and dimensions.

The capacitors discussed are for application in computers, missiles, telephone equipment and other high grade military and commercial electronic equipment and were introduced to meet the need of the electronic industry for a moderately priced, high quality, 125-C paper tubular capacitor. Circle L29 inside back cover.

Time Delay Relays. The A. W. Haydon Co., Waterbury, Conn., has announced the release of two new bulletins to supersede page 13 of their current catalog. These bulletins contain details on the function of the three dial adjustable time delay relays, along with catalog part numbers for the standard ranges and voltages in a-c, d-c and 400 cycles. Bulletin AWH TD404 describes the surface mounting type and bulletin AWH TD405 describes the flush mounting type for panel installation. The timers discussed are especially useful where frequent change in time setting is necessary. Catalog is free on written request on firm's letterhead.

Silicone Rubber. Union Carbide and Carbon Corp., 30 E. 42nd St., New York 17, N. Y. A new 28-page data sheet and compounding study on W-96 Silicone rubber gum stock provides detailed information and instructions for manufacturers, fabricators and product designers. It includes numerous tables and

**BUTTON, BUTTON,
who's got the BUTTON?**

ERIE
BUTTON® SILVER-MICA
CAPACITORS



Still **THE WORLD'S BEST**
HIGH FREQUENCY CAPACITORS

The ERIE BUTTON SILVER-MICA* capacitor is composed of a stack of silvered mica sheets encased in a silver plated brass housing with the high potential terminal connected through the center of the stack. This compact design permits current to fan out in a 360° pattern from the center terminal. ERIE uses short-heavy terminals resulting in minimum circuit inductance. These design features make ERIE BUTTON SILVER-MICA capacitors the best for VHF and UHF applications. They are available in capacity ranges from 15 MMF thru 8,100 MMF, in a variety of styles and sizes, and have many mounting arrangements.

ERIE BUTTON-MICAS are available which comply with or exceed all requirements of Mil C-10950-A.

*ERIE BUTTON Capacitors are made under U. S. Patent 2,348,693

ERIE BUTTON CERAMICONS

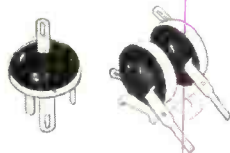

Also available at ERIE are the BUTTON CERAMICONS which have the same mounting and terminal arrangements as the Silver-Mica capacitor. These units have a ceramic dielectric rather than the stacked sheets of silvered mica and may be used in applications where extreme temperature stability is not essential.

**ERIE HI-RELIABILITY
BUTTON® MICA
CAPACITORS**



The wide acceptance of ERIE "HR" Hi-Reliability Disc and Tubular Ceramics prompted ERIE to develop a line of Hi-Reliability Button Mica Capacitors. ERIE Engineers are available to work with you on any specific Hi-Reliability program.

Write for complete description and specifications.

ERIE
Electronics

ERIE ELECTRONICS DIVISION
ERIE RESISTOR CORPORATION
Main Offices and Factories: ERIE, PA.
Manufacturing Subsidiaries
HOLLY SPRINGS, MISSISSIPPI • LONDON, ENGLAND • TRENTON, ONTARIO



DC-AC CHOPPERS

For 60 Cycle Use

Built to rigid commercial specifications.

Twenty-two types, both single and double pole.

Long life.

Low noise level.

Extreme reliability.

Write for Catalog 370.

STEVENS ARNOLD INCORPORATED

22 ELKINS STREET
SOUTH BOSTON 27, MASS.



S/A-10

charts not previously available. Circle L30 inside back cover.

EPUT Meters and Controllers. Berkeley Division, Beckman Instruments, Inc., 2200 Wright Ave., Richmond 3, Calif. Magnetic events-per-unit-time meters and magnetic dual preset controllers are described in two new technical bulletins. Both bulletins illustrate the use of Ferristors, small magnetic amplifiers, as vacuum tube replacements. The only tubes used in either instrument are in the r-f power supply.

Series 7600 magnetic EPUT'S discussed consist of input amplifiers, a gate opened and closed by a tuning-fork controlled time base and a series of magnetic decade counting units. The series 5800 preset controllers described combine an input circuit, cascaded preset decimal counting units and two identical output channels.

Design details and application data are contained in both bulletins. Circle L31 inside back cover.

Magnetically Controlled Counter. Magnetics Research Co., 255 Grove St., White Plains, N. Y. Technical bulletin No. 145 illustrates and describes the Magnivider, a magnetically controlled counter featuring magnetic core reliability, long life, low power drain, small size, rugged construction and low cost. Circle L32 inside back cover.

Laboratory Standards. Measurements Corp., Boonton, N. J., has published two new technical bulletins describing its latest instruments—model 275 i-f converter and model 95 standard f-m signal generator.

Also available is a revised bulletin describing the model 505 standard test set for transistors. Circle L33 inside back cover.

Hermetic Seal Terminals. International Resistance Co., 401 North Broad St., Philadelphia 8, Pa. Catalog data bulletin LT-1 contains comprehensive data on construction, applications, specifications, properties, designations, dimensions and installation sug-

NEW GENERAL PURPOSE RELAY

(SERIES 130 RELAY)

THE MOST USEFUL RELAY FOR INDUSTRIAL APPLICATION



NO OTHER RELAY IS SO VERSATILE

SPECIFICATIONS

CONTACTS	RATINGS	COILS	MOUNTING BASE
Single-and-double pole	20 amp. at 115 V	AC & DC to 230 V	Metal strap or bakelite.
Single-and-double throw	60 Cy. AC or 24 V DC	(Interchangeable)	Base can be rotated 90 degrees either direction for mounting convenience.
Aux. DT contacts available	U. L. Approved	Power—2 watts	

DIMENSIONS Base—1" x 3 3/8"

Request complete data on Series 130 Relay.

Wheelock SIGNALS INC.

RELAYS  LONG BRANCH, N. J.



in rain . . .

These high-value resistors are made of a coated, non-hygroscopic material that resists moisture!

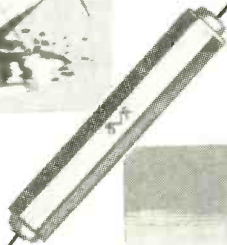

. . . or shine

S.S. WHITE
Molded Resistors
in values up to
50,000 megohms
retain their
characteristics
under widely
varying
temperature
conditions!

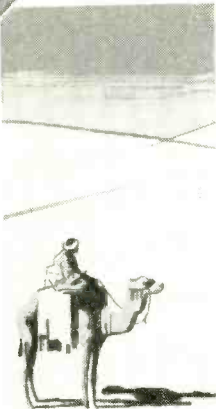

S.S. White

**"All-Weather"
MOLDED RESISTORS
Retain Stability!**

FIXED RESISTANCE VALUES RANGE
FROM 1000 OHMS TO 10,000,000
MEGOHMS!

65X Molded Resistor—1 watt
80X Molded Resistor—3 watts

In hundreds of commercial, industrial and scientific applications, S.S. WHITE Molded Resistors are giving years of all-weather service. These resistors are characterized by their negative temperature and voltage coefficients . . . good stability, durability and mechanical strength . . . non-deterioration of values due to age . . . compactness . . . low noise level.

For our Bulletin 5409, just write to Dept. R.

S.S. White

INDUSTRIAL DIVISION

10 East 40th Street, New York 16, N. Y.
Western Office: 1839 West Pico Blvd.,
Los Angeles 16, Calif.

NEW LITERATURE

(continued)

gestions on type LT hermetic seal terminals. Detailed charts and diagrams are shown in the four pages. Circle L34 inside back cover.

Electronic Wire. General Electric Co., Bridgeport, Conn., has issued a four-page folder on high-temperature electronic wire that meets all the requirements of specifications MIL-W-16878B. The wires described, designed for the internal wiring of electrical and electronic equipment, meters and panels, are available with three types of insulation—thermoplastic, Nylon and silicone for various voltages.

Publication No. 19-586 gives complete specifications and application data. Circle L35 inside back cover.

Switches. Donald P. Massman, Inc., Brewster, N. Y. Four-page catalog No. 200 covers a complete line of push button, lever and turn switches.

Included are illustrations, ratings, dimensions and all other specifications necessary for ordering these switches. A section is also devoted to the company's Electronics Division which specializes in assembling and wiring of control panels, cableforms and the like, to individual customer requirements. Circle L36 inside back cover.

Custom Design and Development. Nelson Instrument Co., 607 Howard St., Evanston, Ill. A six-page brochure describes the company's electronic research, development and production facilities. The brochure illustrates a wide range of custom-built controls, research apparatus, industrial automation, medical instrumentation and other electronic equipment.

The publication also shows how the company takes an idea, develops it into a working prototype and then, if desired, manufactures the product with standard production procedures. Circle L37 inside back cover.

Cooling Fans. McLean Engineering Laboratories, P. O. Box 228, Princeton, N. J. A full line of fans for standard 19-in. racks is illustrated and described with detailed

When you specify
CONNECTORS...



specify
Automatic

Highest standards of quality. Modern high speed automatic machinery, and up-to-date production procedures, based on over 15 years experience in the manufacture of precision parts for the Army, Navy, Air Force and Atomic Energy Commission.

More and more companies in the electronics and telecommunications industries are specifying "Automatic's Connectors."

Our engineers are always ready to discuss your special requirements.

Manufacturers of
RF FITTINGS • RF CONNECTORS
COAXIAL RELAYS • COAXIAL SWITCHES
COAXIAL CABLE ASSEMBLIES • DIRECTIONAL COUPLERS • INSULATED CONNECTING RODS AND SHAFTS • POWER PLUGS • AUDIO PLUGS • BAYONET LOCK AND PUSH ON SUB-MIN CONNECTORS

WRITE, WIRE OR PHONE FOR FURTHER INFORMATION.

Automatic
METAL PRODUCTS CORP.

317 Berry Street, Brooklyn 11, N. Y. • EVergreen 8-0364
IRE SHOW • BOOTH 4426 • N.Y. COLISEUM

$$= m_1 \ddot{x}_1 + c_1 \dot{x}_1 + k_1 (x_1 - x_2)$$

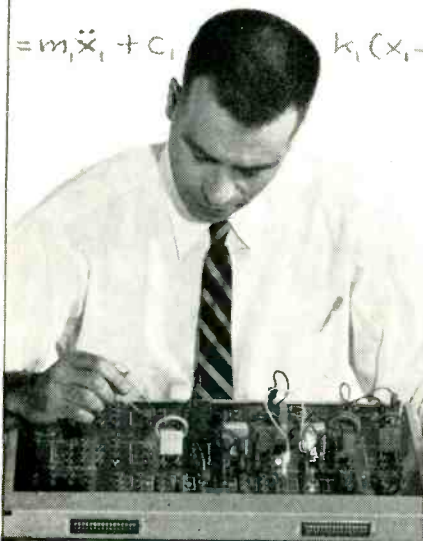

A PERSONAL TOOL FOR EVERY ENGINEER

*Portrait of 1 engineer
doing the work of 2*

ANALOG COMPUTER MODEL 3000

Simplified analog computer solves wide variety of engineering problems. Detachable problem boards and plug-in components facilitate rapid problem set-up. Function generator, multiplier, chopper stabilizer, and other accessories available. Write for complete data. Model 3000, \$1150 FOB Factory.

Problem board \$95

DONNER SCIENTIFIC COMPANY

804 Galindo Street
Concord, California

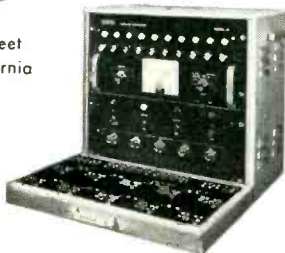

specifications in a four-page two-color catalog. Standard RETMA notching allows mounting on rack—no cutting or fitting is necessary. Filters are replaceable. Grills are stainless steel. Copies of the catalog are available free. **Circle L38 inside back cover.**

Boron Carbon Resistors. International Resistance Co., 401 N. Broad St., Philadelphia 8, Pa. Catalog data bulletin B-6b covers a line of boron-carbon Precistors. The four pages contain comprehensive data on construction, characteristics, applications, types, identification, resistance element, terminals and insulation. Detailed charts and graphs are included. **Circle L39 inside back cover.**

Passive Cathode Material. Superior Tube Co., 1523 Germantown Ave., Norristown, Pa. Catalog section No. 51 presents complete information on Cathaloy P-51, a new passive cathode material featuring a hot yield strength of approximately 5,000 lb per sq in. at 800 C. The material is designed for electronic tubes which require the low rate of barium evolution, minimum sublimation and freedom from interface impedance characteristic of passive cathodes, but at the same time must operate under conditions of shock and vibration. **Circle L40 inside back cover.**

Variable Capacitors. Hammarlund Mfg. Co., Inc., 460 W. 34th St., New York 1, N. Y., has available a new catalog on variable capacitors. The publication lists all standard Hammarlund variable capacitors, providing complete electrical and mechanical information on each. **Circle L41 inside back cover.**

Component Sales Catalog. Atlas E-E Corp., 47 Prospect St., Woburn, Mass. A loose-leaf perforated sales catalog contains descriptions and price information on a wide variety of components. Among those included are a variety of clips and clamps, sub-miniature-tube holders and shields, shield inserts, Lucite cap nuts, Nylon screws and rivets, adhesive preforms, printed circuits, name-



*Why
not move
to*

JACKSONVILLE
FLORIDA

Electronics manufacturers are turning to Florida for ideal plant sites.

Jacksonville, Florida is the hub of the Southeast, strategically close to aircraft, guided missile and other activities that represent a great market for electronics products.

Jacksonville has an excellent manpower pool which is growing weekly as trained men from electronics companies retire or are released from the Armed Services.

Jacksonville's sunny year-round good weather assures reduced construction, maintenance and heating costs. Jacksonville is strategically situated for serving both Southeastern and Latin-American markets. Jacksonville offers a most friendly tax climate, too.

Ask us for "THE JACKSONVILLE STORY", a factual, condensed report of Jacksonville's advantages. Enjoy the benefit of our complete plant site files. And remember, Jacksonville treats all negotiations and inquiries with the utmost confidence.

The CITY OF JACKSONVILLE, Florida
Electric and Water Utilities

The COMMITTEE OF ONE HUNDRED
Jacksonville Chamber of Commerce

604-E Hogan Street

Phone ELgin 3-6161

plates and micropin sockets. Circle L42 inside back cover.

Data Handling System. Berkeley Division, Beckman Instruments, Inc., 2200 Wright Ave., Richmond 3, Calif., has issued a technical bulletin containing design features of the 5780 data handling system which offers high-speed storage on magnetic tape. The system discussed converts four items of encoded data and encoded time into a form for operation into an electric typewriter or summary punch. Basic units listed consist of high-speed gated counters, tape converters and magnetic shift registers. Operation of the system is described. Circle L43 inside back cover.

Products Catalog. American Rectifier Corp., 95 Lafayette St., New York 13, N. Y. Now available is the latest catalog of equipment manufactured and designed by the company. It illustrates everything from components to complete power supplies and explains the company's method of custom engineering. Circle L44 inside back cover.

Aircraft Switches. Micro Switch, a Division of Minneapolis-Honeywell Regulator Co., Freeport, Ill. Catalog 78 is a 32-page booklet covering the complete line of phenolic encased aircraft switches as well as small, metal-covered hermetically sealed switches and high-temperature switches.

Complete with photographs, dimensional drawings, electrical data and operating characteristics, it describes over 140 different switches, auxiliary switch actuators and terminal enclosures. Switches are shown in a variety of actuator designs, terminal structures and contact arrangements, including spdt, dpdt, double-break, two-circuit, four-circuit and split. Many of the switches are AN, JAN and/or MS approved. Circle L45 inside back cover.

Tubular Capacitors. Good-All Electric Mfg. Co., 120 First St., Ogallala, Nebraska, has released a brochure containing detailed information on six new upright

VACUUM

PRESCRIBED FOR YOUR PRODUCT

THE FOUR AREAS WHEREIN KINNEY HIGH VACUUM OFFERS EXTRAS FOR YOU

- ✓ **QUALITY OF PRODUCT**
- ✓ **UNIFORMITY**
- ✓ **INCREASED PRODUCTION**
- ✓ **SOUND ECONOMY**

Relatively few products require the ultimate in High Vacuum which KINNEY Equipment makes available . . . many requirements are as individual and unique as your appetite. That's why there's such a broad range of sizes and models in the KINNEY line . . . TO PROVIDE A PRESCRIPTION ANSWER TO YOUR VACUUM PROBLEM. Thus, you benefit with Pumps you can "custom tailor" to your needs . . . Pumps that assure the quality, uniformity and low cost of the product plus important savings of time in production.



HIGH VACUUM PUMPS

The range of sizes in KINNEY Oil Sealed Mechanical Pumps extends from small laboratory units developing pressures to 0.2 microns to large production two-stage Mechanical Booster Pumps providing ultimate pressures of 0.1 micron. Additionally, there is a full range of sizes in high performance Diffusion Pumps in both Fractionating and Non-Fractionating Types.

VACUUM SYSTEMS

Completely engineered High Vacuum Standard Systems for Coating, Metallizing, Cathodic Etching, Evaporating, Crystal Growing, Sputtering, Evacuating, Vacuum Molding, or other purposes. Special equipment, engineered to accommodate special production schedules or to handle individual processes, built to your specifications or developed jointly with our engineering staff.

GET THE FACTS

Write for full information on KINNEY High Vacuum Pumps and/or KINNEY High Vacuum Systems.

KINNEY MFG. DIVISION
THE NEW YORK AIR BRAKE COMPANY

3565 WASHINGTON STREET • BOSTON 30 • MASS.

Kindly send me literature describing new developments in

KINNEY High Vacuum Pumps KINNEY High Vacuum Systems

Name _____

Company _____

Address _____

City _____ Zone _____ State _____

for modular
construction
of test
equipment!

PREMIER MODU-RAK

MINIATURE DESK CABINET RACKS

for use with standard 19", 9½",
4¾" wide panels

The most exciting advance in metal housings in years, MODU-RAK makes any part of the most complex electronic system easily accessible for assembly or repair by utilizing horizontal and vertical dividers.

ACCESSORIES FOR SUBDIVIDING MODU-RAK INTO MODULAR UNITS

Vertical and Horizontal Dividers, Angle
Brackets and 9½" and 4¾" Panels.

PREMIER

METAL PRODUCTS CO.

DEPT. E, 337 MANIDA ST.
NEW YORK 59, N. Y.

SEE THEM AT
BOOTH 3833

I.R.E. Show—N. Y. Coliseum
March 18-21

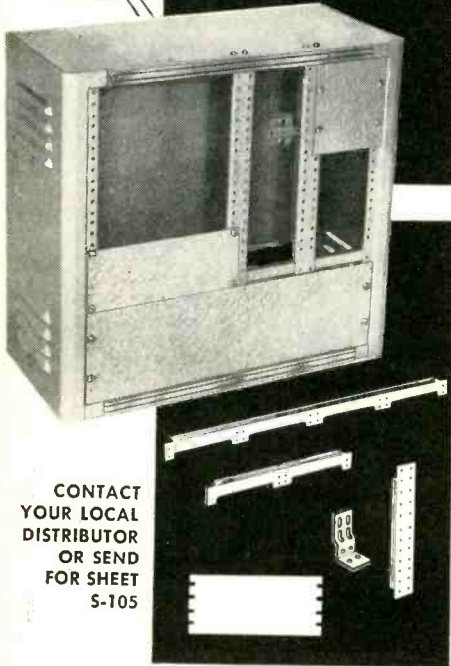

CONTACT
YOUR LOCAL
DISTRIBUTOR
OR SEND
FOR SHEET
S-105

plot your GAIN-FREQUENCY curves
AUTOMATICALLY with the
Moseley **AUTOGRAF X-Y recorder &
Model 60 LOGARITHMIC CONVERTER**



In conjunction with the Moseley AUTOGRAF X-Y Recorder and a motor-driven oscillator, the Model 60 LOGARITHMIC CONVERTER plots gain-frequency curves as rapidly and as often as desired, expediting the design and test of amplifiers, filters, transformers, and numerous other devices formerly requiring time consuming hand-plotting methods. AC or DC models; 20-20,000 cps; 60 db dynamic range.

Write for complete information:

F. L. MOSELEY CO.
409 NO. FAIR OAKS AVENUE
PASADENA, CALIFORNIA

mounting tubular capacitor types. The information is of particular interest in connection with printed circuit applications. Circle L46 inside back cover.

L-F Transformers and Reactors. Southwestern Industrial Electronics Co., P. O. Box 13058, Houston, Texas, has published an eight-page catalog describing a full line of miniaturized l-f transformers and reactors. Catalog 105 describes the complete line of input, output, interstage and avc output transformers, and includes a listing of reactors. Complete design and application information is given, including mounting information and space requirements. Circle L47 inside back cover.

Transformer Laminations. Tempel Mfg. Co., Bryn Mawr at Damen, Chicago 26, Ill., has available a new catalog page on 1/8 in. E & I transformer laminations. Complete technical specifications are given including dimensional drawings, data applying to core stacks with square cross sections, three basic formulas for core stacks with square cross section at 60 cycles and weight and count in sets. Circle L48 inside back cover.

Nickel Cadmium Storage Batteries. Nickel Cadmium Battery Corp., 66 Pleasant St., Easthampton, Mass. To help engineers evaluate the practicability of miniature nickel-cadmium batteries for electronic, aircraft and communications equipment — NICAD's high output sintered plate nickel-cadmium storage batteries are described in an eight-page technical report. Details of development, construction and operation are shown along with curves of discharge and charge characteristics. Circle L49 inside back cover.

Tapping Linear Pots. Helipot Corp., Newport Beach, Calif. Technical paper 804 graphically describes a method of tapping linear pots to reproduce a particular function. The procedure discussed limits loading errors to the best resolution of a single-turn pot while using a minimum number of taps and resistors. Two, four and five-tap pots are dis-

Malco IS YOUR
BEST SOURCE
 FOR
SOLDERING LUGS
TERMINALS
PRINTED CIRCUIT
HARDWARE



HERE'S WHY:

- Specialized high production techniques afford lowest possible unit cost.
- Precision tooling, rigid quality control assure tolerances to critical specifications.
- Ample stocks of over 1000 different parts permit prompt delivery.
- Malco specializes in a complete line of small stampings for Radio-TV, electrical/electronic and automotive industries.
- Our line includes terminals and printed circuit hardware in loose or in chain form for automatic insertion.

Let Malco show you how you can save on production time and costs. Contact us today.



Request handy reference catalog containing specifications on standard and custom-made lugs, terminals, corona rings, pins, contacts and similar stampings.

Malco TOOL and MANUFACTURING CO.
 4023 W. Lake St., Chicago 24, Ill.

Want more information? Use post card on last page.
 ELECTRONICS — March 1, 1957

NEW LITERATURE

(continued)

cussed. Circle L50 inside back cover.

Data Handling System. Berkeley Div., Beckman Instruments, Inc., 2200 Wright Ave., Richmond 3, Calif. Design features of a data-handling system offering high-speed storage on magnetic tape are contained in a new technical bulletin.

The 5780 system described converts four items of encoded data and encoded time into a form for operation into an electric typewriter or summary punch. Basic units discussed consist of high-speed gated counters, tape converters and magnetic shift registers.

Operation of the system is described. Circle L51 inside back cover.

Balancing Machines. Stewart-Warner Corp., 1826 Diversey Parkway, Chicago 14, Ill. Form 24-1 is a 16-page folder illustrating and describing a line of versatile, wide range electronic balancing machines for industry. Chief features and specifications are included. Circle L52 inside back cover.

Autotransformers. General Radio Co., 275 Massachusetts Ave., Cambridge 39, Mass. The new 24-page bulletin 0 describes a complete line of Variac adjustable autotransformers. Dimension drawings, in addition to photographs, are included for all models, and complete specifications and prices are tabulated. Circle L53 inside back cover.

Gages, Instruments and Accessories. Baldwin-Lima-Hamilton Corp., Waltham, Mass. A new line of flat-grid, fine-pitch Bakelite gages, superior replacements for small sizes of wrap-around gages, is among the new products listed in the new price list on SR-4 strain gages, instruments and accessories.

In addition to offering the new flat-grid gages and other new products, the price list contains a thorough discussion of gages and methods of using them and constitutes a complete guide to the proper selection of gages. Circle L54 inside back cover.

Experimental Special!

GENERAL ELECTRIC

DISTRIBUTED

CONSTANT

DELAY
CABLE

\$1.00
 for
one foot



Controlled signal delays — up to 10 microseconds — become accurate and practical with G-E Delay Cable, which can now be released to the industry.

Developed for defense purposes, and recognized as a basic device for establishing input lag, this Distributed Constant Delay Cable weighs only 1/2 ounce per foot and can bend on a 2-inch radius.

This offer is for experimental use, and is limited to five feet maximum per person. Please order through coupon to expedite handling. *General Electric Co., Specialty Electronic Components Dept., Auburn, N. Y.*

Mr. James Gallagher
 General Electric Company
 Specialty Electronic Components Dept.
 Section 2537, Auburn, N. Y.

Send me _____ feet of Distributed Constant Delay Cable, with related data. Remittance at \$1 per foot is enclosed.

NAME _____
 COMPANY _____
 ADDRESS _____
 CITY _____ STATE _____

Progress Is Our Most Important Product

GENERAL ELECTRIC

Want more information? Use post card on last page.

Industry gets ready for 1957 IRE Show and Convention to be held March 18-21 in New York City. Electronics manufacturers continue plant and facility build-up. Engineers and executives in the industry move to new positions of responsibility

IRE National Convention For 1957 Set For New York Coliseum

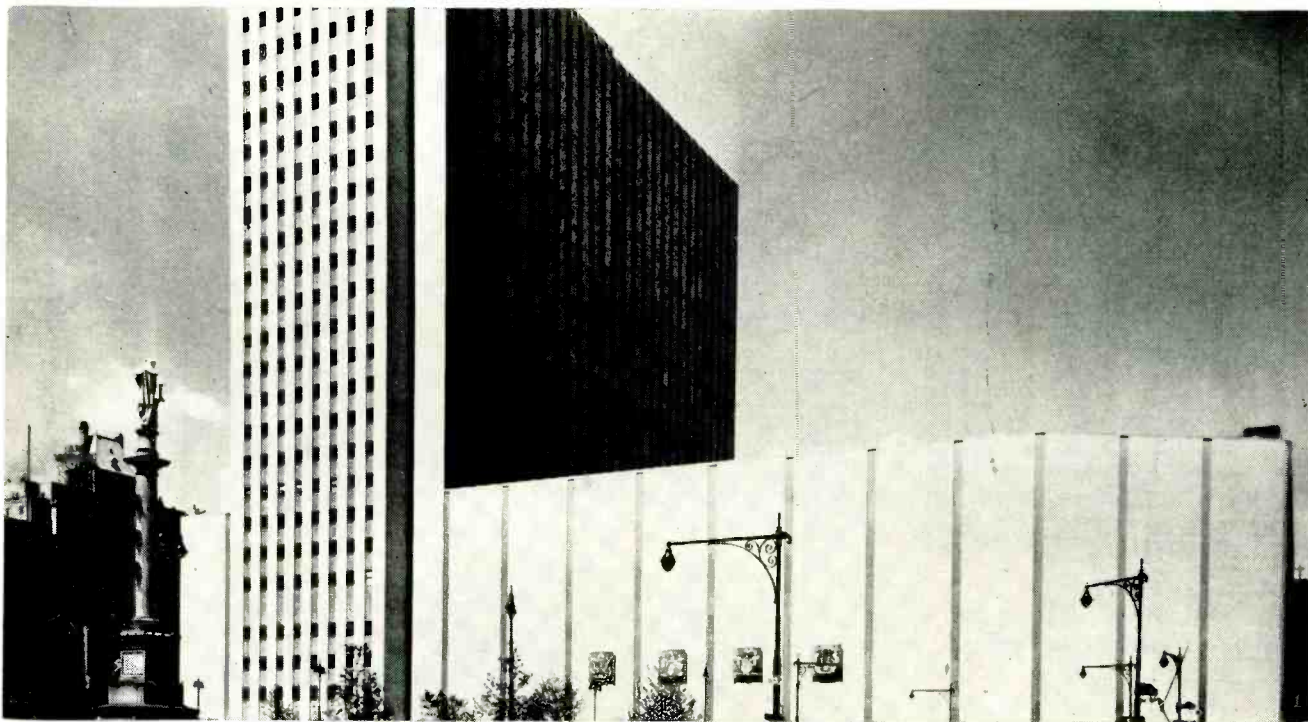

New York's \$35 million Coliseum will be the home of this year's IRE Convention in Manhattan

THE 1957 IRE national convention program will feature 840 exhibits of new apparatus, 275 papers reporting new developments and a new exhibit location for the 50,000 people expected to attend. The Radio Engineering Show has been expanded and moved to the New York Coliseum in midtown Manhattan. The four-day program of technical papers is highlighted by two special symposia on Tuesday evening, March 19. One deals with the topic of a national system of air traffic control, and the other with microminiaturization—the ultimate technique.

► **Show**—Hours for the Radio Engineering Show are 10 a.m. to 9 p.m., Monday through Thursday, March 18-21. The show's 840 ex-

hibits will cover all four floors of the Coliseum. For the convenience of visitors, the exhibits will be grouped, with computers and communications on the first floor, component parts on the second, instruments and microwaves on the third and production tools, materials and services on the fourth.

The annual meeting will be at 10:30 a.m., Monday, March 18, in the grand ballroom of the Waldorf-Astoria Hotel. Principal speaker at the meeting will be Donald G. Fink, director of research of Philco Corp.

The IRE annual cocktail party will be held at 5:30-7:30 p.m., Monday, March 18 in the grand ballroom of the Waldorf-Astoria Hotel.

► **Sessions** — The technical pro-

gram will start at 2.30 p.m. Monday, March 18, and continue through 5:00 p.m., Thursday, March 21. A program of 55 sessions has been organized. Thirty-three sessions will be held at the Waldorf and 22 at the Coliseum. The program of papers and authors begins on page 461 of this issue of **ELECTRONICS**.

The annual IRE banquet will be held at 6:45 p.m., Wednesday, March 20, in the grand ballroom of the Waldorf-Astoria Hotel. Presentation of IRE Awards by John T. Henderson, IRE president, will be made.

The spokesman for the IRE fellows will be Major General James D. O'Connell, U.S. Army Signal Corps. Toastmaster will be Rear Admiral C. F. Horne of Convair.

I-S SPRINGS of beryllium copper can help you

IMPROVE YOUR PRODUCT'S QUALITY, REDUCE YOUR COST, INCREASE YOUR PRODUCTION

Instrument Specialties Company specializes in the design and custom manufacture of age-hardened alloy springs. With our specially developed processes and machines, our engineers are able to

realize the fullest performance potential from the superior spring materials around which I-S service to designers and manufacturers has been developed.



**FOR
HIGH
PRODUCTION**

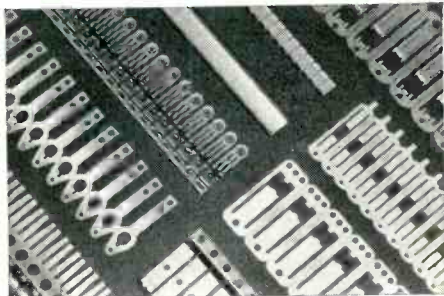

STRIP SPRINGS

Fabricated from beryllium copper. Easily handled, readily broken apart by hand or used in automatic or semi-automatic assembling devices and contact riveting machines. Individual pieces may be broken off without trace of burr. Eliminate sorting, untangling and handling of loose pieces. Springs may be produced in strips to various shapes; formed angles may be held within plus or minus one degree. Heat treated in multiple fixtures to insure uniformity, close tolerances and elimination of variations in spring-back.

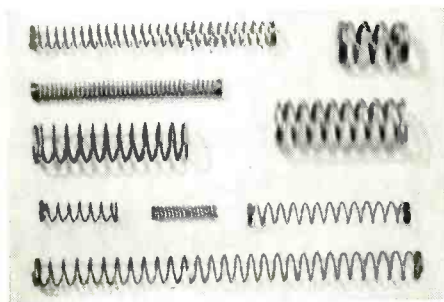

COIL SPRINGS

Made from laboratory tested beryllium copper wire. Special coiling and heat treating equipment insures 100% uniformity. Guaranteed rigid tolerances held on diameter and load tests at specified deflection. These factors combine to assure increased service life through higher endurance strength — make products perform more consistently by eliminating drift, set or fatigue. Furthermore, they eliminate expensive hand adjustment and reduce inspection costs of finished product.

**FOR
LOW
ACTIVITY**

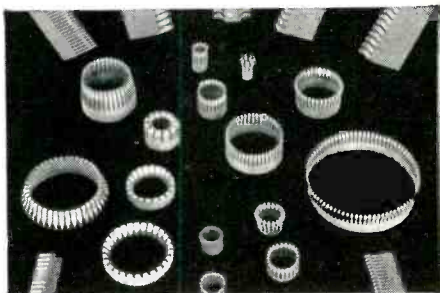

HIGH FREQUENCY SPECIALTIES

We are equipped to supply standard mating parts for use with 2C-39, 2C-40, 2C-43 and 3C-37 tubes, or custom made parts in related fields. Grounding strips and contact fingers can be supplied in standard or special contours. "Flea" contacts for co-planer type subminiature tubes and transistors.



SHORT-RUN SERVICE

For those who need quick delivery of parts in pilot quantities or require a low-cost proving ground for spring designs. I-S methods eliminate expensive tooling. Laboratory controlled, precision produced — yet at lower cost than is possible with permanent, high-activity tools. We are equipped to handle conventional beryllium copper stampings and screw machine products in short runs or in high production.



INSTRUMENT SPECIALTIES CO., INC.

258 Bergen Boulevard

Little Falls, New Jersey

Telephone: Little Falls 4-0280

A COMPLETE ENGINEERING AND SAMPLE SERVICE

When your product is in the design stage, let us show you how I-S springs of beryllium copper may be designed to fit your needs. Ample stock, flexible facilities, short set-up time speed production of sample lots and trial orders.

SEE US AT THE I.R.E. SHOW — BOOTH 4320!

West Coast Manufacturers Elect Officers For 1957

CALVIN K. TOWNSEND was elected president of the West Coast Electronic Mfrs. Association.

He is executive vice-president of Jennings Radio Mfg. Corp. in San Jose, manufacturers of vacuum capacitors and high voltage vacuum switch equipment.

The West Coast Electronic Manufacturers Association is composed of 225 member companies in the West. The organization consists of three councils located in San Diego, San Francisco and Los Angeles.

The WCEMA board named Hugh P. Moore, board chairman of Lercoc Electronics, Inc., vice-president and member of the board; S. H. Bellue, material manager, Hughes Aircraft



Front row—Left to right, George Koth, Thomas P. Walker, Calvin K. Townsend, Hugh P. Moore, S. H. Bellue, F. E. Gilbert, Jr. Back row—Left to right, Richard B. Leng, J. M. Loge, John A. Chartz, D. C. Duncan, Cortlandt Van Rensselaer, Gerald L. Osborne, Winfield G. Wagener

Company, secretary and George Koth, vice-president of Lenkurt Electric Company, treasurer. Moore

replaces Gramer Yarbrough who resigned from Elgin Electronics to form Yarbrough Sales Co.

Navy Honors Godschall Of Philco For Underwater Missile Work

THE Distinguished Service Award was presented to Charles H. Godschall, manager of tooling and tool engineering for the government and industrial division of Philco Corp., for outstanding work in the development of a new underwater weapon.

The citation, the second to be received by Godschall, reads, "For outstanding service to the U. S. Navy in which he served as a specific consultant to the Chief of the Bureau of Ordnance from 1 April 1954 to 31 May 1956. As a direct result of Mr. Godschall's recom-



Charles H. Godschall and Sidewinder

mendation concerning major improvements in research and development procedures and underwater ordnance, the Navy has now thoroughly documented the design disclosure of a new and advanced anti-submarine weapon. The producibility of this weapon is assured, the functional performance has been demonstrated by in-service testing, and production costs have been reduced by about 40% from the estimated figure. Godschall also worked on Navy's missile Sidewinder currently being produced by Philco.

Fischer & Porter Plans Expansion Of Research And Production

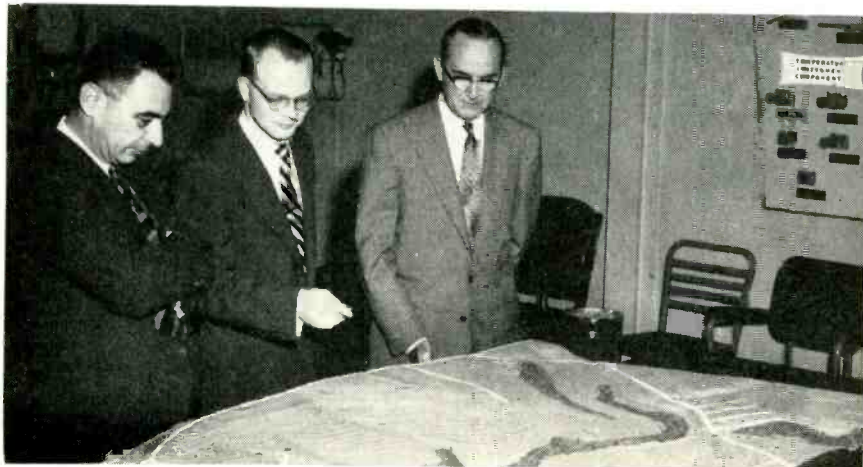

Left to right: Kermit Fischer, president; C. B. Foster of Bucks County and Nathaniel Brewer

FISCHER & PORTER Co. purchased two tracts in central Bucks county, Pa. for expansion plans.

The larger of the two areas will accommodate buildings for offices, research laboratories and additional production facilities. The proposed buildings will occupy but a third of the 120 acre tract.

A nearby 65 acre tract will be developed as a recreational facility for Fischer & Porter personnel. A company country club is planned. There is to be an eighteen hole golf course as well as several tennis courts. A proposed club house will include a restaurant, a day nursery

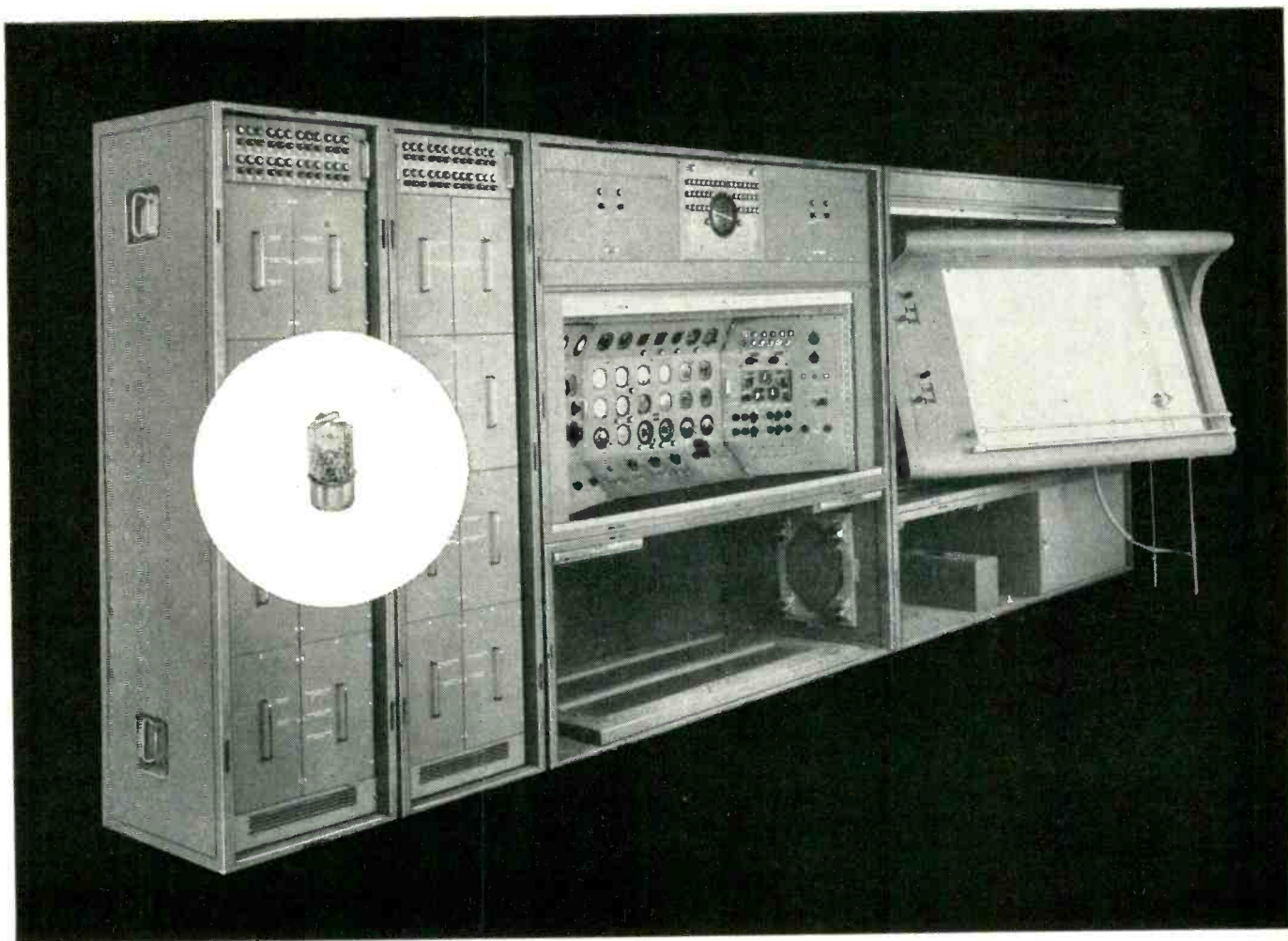

From miniature components to integrated systems

AMF has electronics experience you can use

- AMF experience in electronics covers practically every area of the field, from design through production, of individual components and complete systems, for both government and industry.
- AMF has organized development and production teams experienced in the latest mechanical and electronic techniques. These teams, located throughout AMF, achieve the fine balance so necessary to produce efficient, reliable equipment.

• Particular AMF electronics capabilities and products include . . .

- Data Processing and Display
- Training Devices and Simulators
- Antennas and Mounts
- Communication Systems
- Low-frequency Radar
- Electronic Warfare Devices
- Air Navigation and Traffic Control
- Missile Check-out Equipment
- Electric Motors
- Guided Missile Support Equipment
- Industrial Relays
- Silver-zinc Batteries
- Accessory Power Supplies
- Inverters and Alternators
- Factory Test Equipment

Be sure to see
booths 1506-1508
and 1522 at the
coming I.R.E. Show.

Research, Development,
Production in these fields:

- Armament
- Ballistics
- Radar Antennae
- Guided Missile Support Equipment
- Auxiliary Power Supplies
- Control Systems



Defense Products Group

AMERICAN MACHINE & FOUNDRY COMPANY

1101 North Royal Street, Alexandria, Va.

NOW
from the industry leader

TEFLON*

insulated wire
by **alpha wire**

Available from stock in both extruded and wrapped types in all popular sizes and colors. Put up on spools from 10-ft. to 1000-ft.

For complete technical specifications and catalog data, write for Teflon Bulletin TE-3 — See us at Booth 4321, IRE Show.

These new high-temperature Teflon products, added to Alpha's 2000 in-stock items, give you the industry's greatest variety — from the leader in industrial wire and cable.

*Du Pont tetrafluoroethylene

... from prototype to mass production

ALPHA WIRE CORP., 200 Varick St., New York 14, N. Y.

In Canada: ALPHA ARACON RADIO, 29 Adelaide St. W., Toronto 1, Ontario.

and a number of meeting rooms to be available to both company and community groups.

Chapman Named CBS-Hytron President

ARTHUR L. CHAPMAN has been appointed president of CBS-Hytron. Formerly vice-president-manufacturing of Sylvania Electric, he succeeds Charles F. Stromeyer, who resigned as president of CBS-Hytron.

During his 24-year association with Sylvania, Chapman served in virtually all phases of tube, parts and set production. In 1933, he joined the firm as supervisor of the radio tube material inspection de-



Arthur L. Chapman

partment. After working for several years on special divisional programs, including production of the lock-in radio tube, he was named general foreman of the radio tube plant in Emporium, Pa. in 1942. A year later he became superintendent of the wire and weld plant in Warren, Pa., and in 1944 manager of the plant. In 1950 he was appointed general manager of both the parts and radio and television divisions. He was made a vice-president in 1951.

In 1953, he was appointed vice-president in charge of electronic operations. In this capacity he was responsible for the operations of Sylvania's radio and television, parts, electronics, radio tube, and television picture tube divisions.

In 1956, Chapman was appointed vice-president-manufacturing of

Appointments to the Scientific Staff for

Electrical Engineers

are available in the following areas

- design and construction of a modern high speed DIGITAL COMPUTER
- design and development of control systems and power amplifiers for a 25 B.e.v. ALTERNATING GRADIENT SYNCHROTON

For information please write to:

Office of
Scientific Personnel

**Brookhaven
National
Laboratory**

Upton, L. I., N. Y., YAphank 4-6262



for MICROWAVE SIGNAL ANALYSIS

of radar communications equipment and components

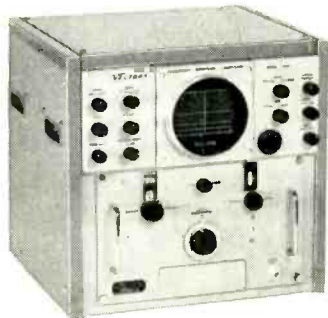

VECTRON SA30 SERIES MICROWAVE SPECTRUM ANALYZER

Clearly and accurately displays:
 Frequency of carrier and side bands
 Undesired frequencies generated
 Relative power of all signals
 Details of intermittent signals.

SA30WR-1 2,000 to 12,000 mc/s
 Direct Reading Dial

Recommended for laboratory or production use where wide frequency coverage is needed and moderate frequency accuracy (0.5%) is required.

SA30X5 8,500 to 9,660 mc/s
 Direct Reading Dial

Frequency Accuracy 0.05% or better
 Ideal for use in design, production and maintenance facilities where major requirements are fast, accurate readings within its frequency range.

THE SA30 SERIES IS LIGHTER: — uses all aluminum construction in a portable 80 lb. bench-top unit or as two rack-mountable assemblies.

SEND FOR BULLETIN NO. SA30 OR PICK UP YOUR COPY AT



BOOTH 3106-3108
 1957 RADIO ENGINEERING SHOW
 MARCH 18-21 NEW YORK COLISEUM

VECTRON, inc.

Electronic and Electro-Mechanical Equipment

1609 Trapelo Road • Walham 54, Mass.



VECTRON'S MINIATURIZED SPHERE RESOLVER requires less than 5 in/oz input for 1 to 2 in/oz from the sine and cosine output shafts. This precision mechanical resolver is 1 1/2" square with a body block over 2 1/8" long.

This product of Vectron design and manufacture is another example of the electro-mechanical problems which Vectron can help you solve.

Want more information? Use post card on last page.

ELECTRONICS — March 1, 1957

PLANTS AND PEOPLE

(continued)

Sylvania. In this assignment, he provided on a company-wide basis planning and coordination in the areas of automation and equipment development, purchasing, traffic and industrial engineering. He also had the responsibility for evaluating the manufacturing facilities of new acquisitions or ventures which Sylvania wished to investigate.

Motorola Selects TV Engineers

GAIRTH J. HEISIG has been named director of television engineering for Motorola. William Hinton was named assistant to the director of television engineering.

Heisig has been with Motorola since 1945, starting in the communications and electronics division. He was transferred to television engineering in 1950 and was named staff consultant. Heisig succeeds Edward Passow, who has resigned.

Before his association with Motorola, Heisig was associated with the M.I.T. Radiation Laboratory for two years.

Karl H. Horn was appointed chief television engineer for the firm. Lawrence Mattingly was named assistant chief television engineer.

In his new appointment Horn succeeds George Fyler, who has resigned.

Horn has been with the firm since 1953 starting as engineer. In 1954 he was named chief engineer of the Canadian operation. Before his association with Motorola, Horn was located for two years with the Menzel Radio Manufacturing Co. and two years with Canadian Comstock.

Electronics Conference Elects Officers

CHRISTOPHER E. BARTHEL JR., assistant director of Armour Research Foundation of Illinois Institute of Technology, has been elected president of the National Electronics Conference for 1957.

Other officers named for the 1957 conference, to be held Oct. 7-9 at the Hotel Sherman in Chicago, are: Chairman of the board, Howard



NOW
 greater accuracy for
ANALOG COMPUTERS
 with the
VERNISTAT®
 a.c. potentiometer

In analog computer design, where system accuracy is directly related to the accuracy of the computing elements, the new VERNISTAT a.c. potentiometer meets the most exacting design requirements. The VERNISTAT overcomes the severe limitations placed on computer performance up to now by the use of conventional potentiometers. Errors introduced by loading, phase shift and wear are substantially reduced.

The VERNISTAT a.c. potentiometer represents a truly fundamental advance in precision potentiometer design. The combination of a tapped autotransformer and an interpolating resistance element overcomes the limitations of the purely resistive potentiometer. The VERNISTAT principle provides inherently high linearity, low output impedance, very small phase shift and long life. Relatively high output current capability and the ease with which nonlinear functions may be generated are plus features of the VERNISTAT. The unit is normally supplied as a turn version and it may also be arranged for continuous rotation.

Use of the VERNISTAT potentiometer in analog systems results in a general improvement in performance characteristics. Greater simplicity, through elimination of isolation amplifiers is often an added dividend.

For further information write to:

vernistat®
 division
 PERKIN-ELMER CORPORATION
 Norwalk, Connecticut

Want more information? Use post card on last page.

SANDERS MINICUBE BLOWER

*ruggedly
constructed
for use on aircraft
and guided
missiles*



The Sanders Minicube Blower contains both miniature blower and motor in a rugged, 1" cube. A single package, it is designed for use on aircraft and guided missiles operating under severe environmental conditions. It is operable over wide ranges of vibration, acceleration and temperature, and is suitable for many exacting applications.

The Sanders Minicube Blower can be used to:

- Eliminate hot spots in subminiature equipment
- Prevent fogging of lens or viewing glasses
- Cool Klystrons and other electronic tubes and devices
- Maintain uniform flow of air in restricted space

SPECIFICATIONS

Output: 3 cubic feet of air/minute
Speed: 22,000 RPM
Input: 400 cps, 4 watts
Size: 1" x 1" x 1"
Voltage: Model 1: 6 volts
Model 2: 26 volts
Weight: 1 oz.

For detailed specifications, write Dept. E-3



Want more information? Use post card on last page.
442

H. Brauer, Bell and Howell Co.; executive vice-president, Joseph H. Enenbach, Illinois Bell Telephone Co.; secretary, John S. Powers, Bell and Howell Co.; treasurer, Charles W. McMullen, Northwestern University; executive secretary, Gordon J. Argall, De Vry Technical Institute; legal advisor, Alois W. Graf, Graf, Nierman and Burmeister, and assistant treasurer, James H. Kogen, Askania Regulator Co.

The conference is sponsored by the Illinois Institute of Technology, AIEE, IRE and Northwestern and Illinois universities, in cooperation with Notre Dame, Purdue, Michigan State, Michigan, and Wisconsin universities, RETMA and SMPTE.

Officers For 1957 Appointed By IRE

THE IRE board of directors appointed six members to the board for 1957.

Reappointed as treasurer of the IRE was W. R. G. Baker, vice-president of General Electric. Haraden Pratt was appointed to his fifteenth term as IRE secretary. Donald G. Fink, director of research of Philco Corp., was reappointed as editor of the IRE.

Appointed as director were Alfred N. Goldsmith, consulting engineer and editor emeritus of the IRE; A. W. Graf, partner of the law firm of Graf, Nierman and Burmeister; and William R. Hewlett, vice-president of Hewlett-Packard Co. and past president of IRE.

► Award—The Institute of Radio Engineers' 1957 Medal of Honor, the highest technical award in the radio and electronics field, will go to J. A. Stratton, Chancellor of MIT. The award is to be given "for his inspiring leadership and outstanding contributions to the development of radio engineering at a teacher, physicist, engineer, author, and administrator."

The formal presentation of the award will be made at the annual IRE banquet, to be held at the

Don't MONKEY AROUND



WITH YOUR TRANSIT CASE AND REUSABLE CONTAINER PROBLEMS

Take them to Skydyne. For Skydyne engineers have years of experience in the design, development and production of reusable containers for electronic equipment. Their specialized "know how" brings practical, economical solutions.

What's more, they assume complete responsibility from design to delivery of your case, and let you concentrate on your own work. Thus, both the equipment and its transit case are ready at the same time.

It makes a lot of sense to find out more about this complete design and engineering service. Remember this—"Any equipment is only as good as its container which insures a safe arrival in good operating condition."

You can easily learn more about Skydyne's exclusive service and how it can help you. Write to

SKYDYNE INC.

River Road Port Jervis, N. Y.

"Your Mark of Quality"



SANDWICH MATERIAL

MOLDED FIBREGLAS

Want more information? Use post card on last page.
March 1, 1957 — ELECTRONICS

Waldorf-Astoria Hotel, New York City, on March 20, 1957 during the IRE National Convention.

Dr. Stratton joined MIT in 1925 and served on the staff of the electrical engineering and physics departments for twenty years. In 1945 he was appointed head of the Research Laboratory of Electronics. He became vice-president and Provost of MIT in 1949, and this year was appointed to the specially created position of Chancellor.

Westinghouse Tube Names Two

GEORGE C. SZIKLAI has been named technical assistant to R. T. Orth, vice-president and general manager of the Westinghouse electronic tube division.

Sziklai, holder of 110 patents in electronics and other fields, will be a general consultant to the division on electronic systems and the applications of tubes and semi-conductors to these systems.

In addition to electronics, Sziklai has done work in physics, chemis-



G. C. Sziklai

try and mathematics. He has worked for several American concerns, the most recent one being RCA.

Franklin P. Hinman has been appointed operations manager of the cathode-ray and power tube departments of the tube division.

In his new position he will be responsible for all phases in the design, development, engineering and manufacturing of cathode-ray and power tubes, as well as the industrial relations and administra-



GET 3 DIGITAL INSTRUMENTS IN 1
and eliminate readout error

THE HYCON RACK MOUNTED AC-DC VOLT-OHMMETER

MODEL 615 AR
Digits are 1/2" high ...

Decimal point and polarity sign are illuminated.

Readings are repeatable within 1 digit with no parallax or interpolation errors.

Time-proven electromechanical system

PLUS THESE OTHER IMPORTANT FEATURES

- Complete overload protection
- Automatic "off-scale" indication
- Jack to permit reading retention
- Special designed counter, life-tested for years of use
- Available in same unit size with complete print-out facilities for permanent records

Ideal for a broad range of applications, including production-line testing, field service testing, high-precision research and development work, incoming parts inspection and quality control.

The Hycon 615AR applies extremely low current through unknown resistance (2.7 ma. max. on XI range...0.00027 ma. max. on X1000 range). Only 5 1/4" high, the unit fits any standard 19" relay rack.

For further information, write for Bulletin G-12

SPECIFICATIONS

RANGES — DC: 0-1, 10, 100, 1000 volts
AC: 0-10, 100, 1000 volts
Resistance: 0-1k, 10k, 100k, 1 meg, 10 meg

DC INPUT RESISTANCE — 11 megohms
AC FREQUENCY RESPONSE — Direct Probe: 30 cps — 3 mc
Crystal Probe: 50 kc — 250 mc

INDICATOR — 3-digit counter with illuminated decimals and polarity sign

ACCURACY — DC and Resistance: 1% full-scale (0.1% optional)
AC: 2% full-scale

POWER REQUIREMENTS — 115 volts, 60 cycles, 50 watts

DIMENSIONS — Standard 19" rack panel 5 1/4" high; chassis 11 1/4" deep

FINISH — Navy Gray 15090-111-2 Panel (or customer preference)

Hycon

ELECTRONICS, INC.

1030 South Arroyo Parkway
P. O. Box "D"
Pasadena, California

A subsidiary of
HYCON MFG. COMPANY

new CHASSIS-TRAK Roller Cabinet Slides
 give you **faster, easier servicing of electronic equipment**

ultra-thin tilt lock design saves space, fits standard cabinets

Service and repair of your electronic equipment is easier and faster with new Chassis-Trak roller slides. Chassis slides out of cabinet effortlessly. Stainless steel rollers at pressure-bearing points are rugged, long-wearing.

Chassis-Trak's famous "tilt-lock" design gives you maximum access to top, bottom, and rear of chassis. Pushbutton provides instant emergency chassis removal. "Ultra-thin" design (.350") conserves valuable cabinet space; supports up to 175 lbs. Chassis-Trak fits standard 19" panel racks.

Experienced Chassis-Trak representatives in your area will gladly help you plan standard or custom slide installations.

Visit us at I.R.E. Show booth 4001

write:

CHASSIS-TRAK, INC., Dept. E -3
 525 S. Webster Ave., Indianapolis 26, Indiana

tion of the Elmira plant. The creation of this new post is part of an overall reorganization of the electronic tube division into product groups.

Hinman joined Westinghouse in 1951. Prior to that, he had been associated for nine years with RCA in manufacturing and engineering. In 1953, he was named product manager for the Elmira plant, and in 1954 manager of manufacturing.

Audio Engineers Honor Farmer

THE Audio Engineering Society Award was presented to Herbert E. Farmer, in recognition of his service to the Society. In addition, the Society awarded six fellowship certificates.

Farmer, who has served as secretary and chairman of the Society's Los Angeles section, is director of audio-visual services at the University of Southern California. He joined the University in 1942, as assistant professor in the department of cinema. He is also a private consultant in motion picture production and sound facilities design. In 1947 he worked on Project Sandstone at the University of California.

Honeywell Forms Boston Division

MINNEAPOLIS-HONEYWELL'S Doelcam and Transistor divisions in Boston have been consolidated into a single unit to be known as the Boston division.

The new division is composed of two sections: a semi-conductor product section (power-type transistors), and an instrument section (synchro motors, gyroscopic instruments, electronic control and test equipment).

Over-all direction will be under George J. Schwartz, vice-president and general manager of the new division. John J. Wilson, formerly president of the Doelcam division, will direct policy as senior corporate vice-president in the area.

Production of the various prod-

reduce shrinkage costs

Condensers, washers, neon electrodes, tube spacers, capacitor film . . . wherever application requirements call for mica insulation, RELIANCE can solve your problems.

For almost 30 years, RELIANCE quality has remained byword in the field of mica products. Adherence to critical tolerances is assured, shrinkage costs reduced, quality guaranteed.

Write TODAY and let us aid you in your mica insulation engineering problems. Our design and development staff is at your disposal.

RELIANCE

RELIANCE MICA CO., INC.
 341 39th Street
 Brooklyn 32, N. Y.

Mica Specialists to all Industry

Couch Rugged



RELAYS

Specify the COUCH MODEL 2A or 4A relay whenever HIGH SHOCK-HIGH VIBRATION capabilities are required and for DRY-CIRCUIT applications.

VIBRATION . . . 5 to 25 cps @ 0.4" peak to peak excursion; 25 to 2000 cps @ 20G acceleration; No contact opening, relay energized or de-energized.

SHOCK ELECTRICAL . . . 75G for 10 milliseconds minimum. No contact opening, relay energized or de-energized.

SHOCK MECHANICAL . . . 200G minimum . . . no physical damage to relay or change in electrical characteristics.

Models 2A and 4A are subminiature, hermetically sealed, D.C. relays which meet and in several respects exceed the requirements of MIL-R-5757B. They are actuated by a "balanced-armature" rotary motor. Both models are particularly suited to dry-circuit switching applications.

LEADING PARTICULARS

Ambient Temp.:	-65°C to +125°C
Weight:	3.2 oz. maximum
Height of Case:	1½" maximum
Diameter of Case:	1¾" maximum
Terminals:	Flattened & pierced
Contact	DPDT — Model 2A
Arrangement:	4PDT — Model 4A
Contact Material:	Fine silver to molybdenum
Operation:	Simultaneous operation, simultaneous release, no contact bounce
Pull-in-power (Coil):	¾ watt — Model 2A ½ watt — Model 4A

Test Data and Literature on Request
Built-in Dependability

S. H. Couch Company, Inc.

NORTH QUINCY 71, MASSACHUSETTS

Want more information? Use post card on last page.

ELECTRONICS — March 1, 1957

PLANTS AND PEOPLE

(continued)

ucts will be centered in the recently purchased, 250,000-sq-ft plant in Boston. Engineering and administration will be consolidated in the division's existing two-story building there.

NCR Electronics Promotes Edwards

WALTER G. EDWARDS was named engineering department manager of the National Cash Register Company electronics division in Hawthorne, Calif.

Formerly the facility's chief systems engineer, Edwards now assumes responsibility for all engineering activities of the division.



Walter G. Edwards

He has been with the organization since 1952, when it was the Computer Research Corp. During the past four years, he has designed a readout system using ferro-resonant flip-flops, supervised installation of the NCR 105 computer in Washington, D. C., and developed various digital computer systems devices for which patents are now pending.

Presidential Aid To Address IRE Group

EDWARD P. CURTIS, President Eisenhower's special assistant for aviation facilities planning will report the results of his group's year-long study to come up with recommendations for meeting the growing needs of U.S. aviation

High Power* Oscillator

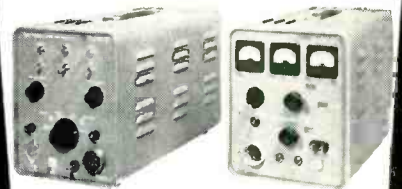

200-2500 mc/s

Here is a proven source of dependable, high-level r-f power that provides complete coverage from 200 to 2500 mc/s with just one simple band change. The model M1141 provides exceptional frequency stability and choice of self-contained sinusoidal or square wave modulation. These features, plus reliable, trouble-free operation, make the M1141 the best general purpose oscillator available anywhere. Look at the specifications listed below.

MAXSON MAKES IT

Specifications

Frequency Range:

200 to 2500 mc (in two bands, 200-1050 and 950-2500 mc/sec) Coverage to 3000 mc/s upon special request.

*Power Output:

200-400 mc—at least 40 WATTS
400-1050 mc—at least 25 WATTS
1000-2500 mc—at least 10 WATTS (Power output variable by front panel control.)

Calibration Accuracy:

±1% or ±5 mc, whichever is greater

Resettability: < 0.1%

Output Impedance:

50 ohms (nominal)

Modulation:

1. External; 2. Internal square-wave, 400 & 1000 cps; 3. Internal sine-wave, 400 & 1000 cps; 4. CW

Power Requirement:

115V a-c, 50/60 cps, single-phase, 375-watt

Request "Maxson Instruments Catalog Sheet 101E".



MAXSON INSTRUMENTS

47-37 Austell Place
Long Island City 1, New York

Division of the W. L. Maxson Corporation

Want more information? Use post card on last page.

NO MICROWAVE
SPECIFICATION
IS TOO CRITICAL FOR
J-V-M*

***CUSTOM BUILDERS
AND DESIGNERS OF:**

CAVITIES

**MIXERS • DETECTOR MOUNTS
DUPLEXERS • MULTIPLIERS
ROTARY JOINTS • BENDS
TWISTS • OTHER COMPLEX
COMPONENTS & ASSEMBLIES**

Application-engineered microwave parts and complex assemblies are our specialized field. We'll manufacture components to your prints ... or we will design and integrate them into your application.

You can depend on J-V-M for close coordination, guaranteed electrical performance and "know how" that is attested by innumerable assemblies ranging from dc. to 40,000 mc. now in industrial and military use.

FOR EXAMPLE:

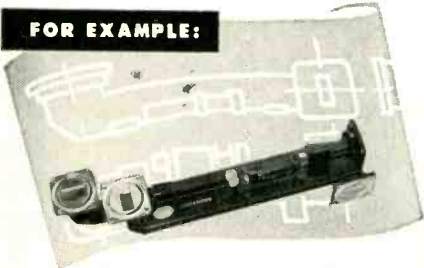

1. Variable vane directional coupler ... sliding vane type ... high directivity—low VSWR.

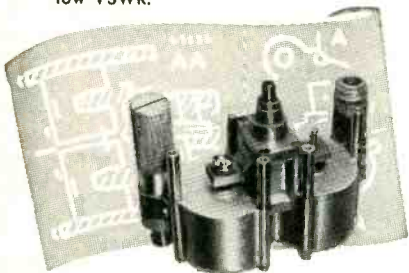

2. Pre-selector-mixer ... S band ... 50 ohm input impedance ... high Q double-tuned ganged cavities ... detector output ... frequency stable from -55° to $+85^{\circ}$ C.

Get full information on J-V-M standard or custom-engineered microwave parts and components, also complex mechanical assemblies. Request catalog today.

**J-V-M ENGINEERING
COMPANY**

4631 Lawndale Avenue, Lyons, Ill.
(Chicago Suburb)

Want more information? Use post card on last page.

446

PLANTS AND PEOPLE

(continued)

during the next 20 years at a luncheon meeting jointly sponsored by the IRE professional groups on Aeronautical & Navigation Electronics (PGANE) and Military Electronics (PGMIL).

The luncheon is scheduled for March 19, 12:30 pm. (during the national IRE convention) at the Belmont-Plaza Hotel in New York City.

Brooklyn Polytech Appoints Weber

ERNST WEBER was appointed to the newly-created position of vice-president for research at the Polytechnic Institute of Brooklyn.

Research projects at Polytechnic now represent annual expenditures of more than \$2,250,000.

Prior to assuming this post, Dr. Weber was director of Polytechnic's Microwave Research Institute. Under his direction, MRI annually expended almost \$1 million on research projects for the armed forces.

Dr. Weber came to Polytechnic in 1930 as a visiting professor. Since 1945, he has been head of the department of electrical engineering and director of the Microwave Research Institute.

RCA Labs Selects Two Directors

At RCA Laboratories Rolf W. Peter was appointed director of the physical and chemical research laboratory and Allen A. Barco director of the systems research laboratory.

Dr. Peter, research physicist at RCA Laboratories since 1948, succeeds Humboldt W. Leverenz, who was named assistant director of research, RCA Laboratories. Barco, who has been engineer-in-charge of the industry service laboratory at the David Sarnoff Research Center, succeeds Dr. George H. Brown, who was appointed chief engineer, RCA commercial electronic products.

Since 1953, Dr. Peter has supervised microwave and gaseous electronics research in the Electronic Research Laboratory of RCA

NEW

magnetically
-controlled

COUNTER -DIVIDER

Magnivider



Using a "ladle-bucket" principle, magnetic cores in the unique Magnivider circuit set a new high of reliability and ruggedness wherever counting, scaling or frequency division is required.

Self-contained Magnivider plug-ins are ideal for your new equipment designs. Compared to conventional four-tube counters, one-tube Magnividors offer

- one-third the size
- 50% less power drain
- twice the reliability
- compatible scales of 9-10-11
- counting rates from 0 to 50 Kc.
- both low and high impedance outputs
- direct cascading without buffers

Magnividors have a wide range of applications

- Random counting
- Preset counting
- Cycle counting
- Frequency division
- Timing chains
- Synchronizing circuits
- Accumulators

Write for our Technical Bulletin 145 to obtain complete information and specifications.

Dept. 103



**MAGNETICS
RESEARCH
COMPANY**

255 GROVE STREET
WHITE PLAINS, N. Y.

Want more information? Use post card on last page.

March 1, 1957 — ELECTRONICS

Laboratories. He has been named chairman of the 1957 Electron Tube Research Conference to be sponsored by the IRE and the AIEE.

Barco recently has directed the new devices applications section of the systems research laboratory. He joined the RCA Industry Service Laboratory in New York as a student engineer in 1947, and was section head when he was transferred to Princeton in 1949.

TASO Names Transmitter Head

RALPH N. HARMON, vice-president for engineering of Westinghouse Broadcasting Co. has been appointed vice-chairman on transmitting equipment for the Television Allocations Study Organization (TASO).

His committee will study television transmitting equipment capabilities, costs, etc., as they might affect television allocations, both uhf and vhf.

Harmon's appointment was made by Dr. George R. Town, executive director of TASO.

Research Award Goes To Shannon

CLAUDE E. SHANNON received the 1956 Research Corporation Award for his work in establishing "Information Theory."

It is concerned with the most efficient way to carry out the communicating process between both man and machine and man and man.

The award consists of an honorarium of \$2,500, a plaque and a citation. It was presented to Dr. Shannon by Joseph W. Barker, chairman and president of Research Corporation.

Dr. Shannon is a professor at Massachusetts Institute of Technology and a mathematical consultant in Bell Telephone Laboratories research department.

Research Corporation is a non-profit foundation established in

20
TO
200 D.P.

SEND YOUR
PRINTS FOR
QUOTATION

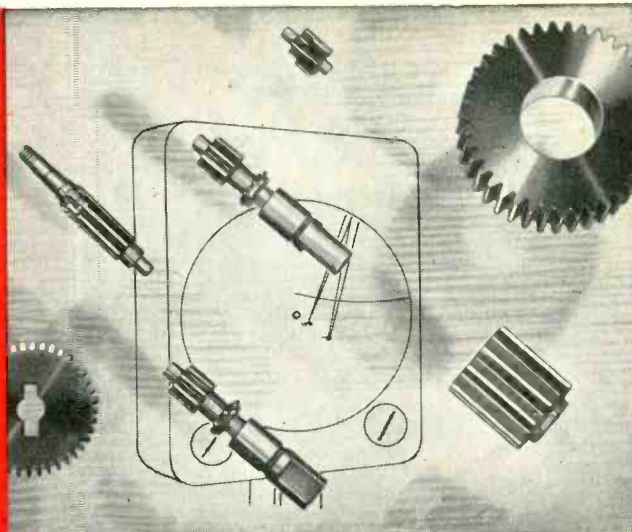

SPURS • HELICALS • WORM AND WORM GEARS • STRAIGHT BEVELS
LEAD SCREWS • RATCHETS • CLUSTER GEARS • RACKS • INTERNALS • ODD SHAPES

THE *Finest*



IN GEARS

Beaver Gear Works Inc.

1021 PARMELE STREET, ROCKFORD, ILLINOIS

EXTENDED FREQUENCY RANGE

with these STANDARD SIGNAL GENERATORS

MODEL 80
2 Mc to 400 Mc
MODEL 80-R
5 Mc to 475 Mc



SPECIFICATIONS

FREQUENCY RANGE: (Model 80) 2 to 400 Mc in 6 bands.
(Model 80-R) 5 to 475 Mc in 6 bands.
FREQUENCY ACCURACY: $\pm 0.5\%$
FREQUENCY DRIFT: Less than .1% after warm-up.
OUTPUT VOLTAGE: Continuously variable from 0.1 to 100,000 microvolts (-7 to -127 DBM).
OUTPUT ACCURACY: $\pm 10\%$ at 0.1 volt from 5 to 200 Mc.
 $\pm 15\%$ at 0.1 volt from 200 to 475 Mc.
MODULATION: AM is continuously variable from 0 to 30%.
Internal modulation, 400 and 1000 cycles.
External modulation, 50 to 10,000 cycles.
RESIDUAL FM: Less than 500 cps at 450 Mc for Model 80-R,
and correspondingly lower for both models at lower frequencies.
POWER SUPPLY: 117v, 50-60 cycles, 70 watts.

FEATURES

- Direct-Reading scales and dials; individually calibrated.
- Convenient microvolt and DBM output scales.
- Accurate indication of output voltages at all levels.
- Low residual FM due to hum and noise.
- Provision for external pulse modulation.

Laboratory Standards



MEASUREMENTS
CORPORATION
BOONTON · NEW JERSEY

The Diamond Pivot

and "Calibrated Spring" Shock
Mounted Sapphire Jewel.



SENSITIVE RESEARCH

First

in ELECTRICAL
INSTRUMENT
ENGINEERING

NEW



CORE LOSS TEST SET. A high accuracy multirange test set for the measurement of core loss and exciting current characteristics of soft magnetic materials at commercial frequencies up to 500 cps.

NEW



EDGEWISE PANEL INSTRUMENT with a long 7.1" hand drawn mirrored scale. Case design is panel mounted equivalent of all .25% accurate AC and DC portable reference standard instruments.

See these **NEW** instruments
at Booth No. 3410
New York IRE Show.

**SENSITIVE
RESEARCH
INSTRUMENT
CORPORATION**

NEW ROCHELLE, N. Y.



Symbol of Quality

ELECTRICAL INSTRUMENTS OF PRECISION SINCE 1927

Want more information? Use post card on last page.
448

1912 by the late inventor-scientist Frederick Gardner Cottrell to support scientific research in colleges, universities and scientific institutions.

Other award winners have included: Robert B. Woodward, Vannevar Bush, Percy W. Bridgman, Ernest O. Lawrence, Bruno Rossi, Edwin M. McMillan, Edward C. Kendall, Samuel A. Goudsmit, George E. Uhlenbeck, and H. S. Black.

Dr. Shannon, who has been with Bell Laboratories since 1941 has made outstanding contributions to the communications field, especially in mathematical theory of communications, Boolean algebra, cryptography, and computing circuits.

In January, 1956, he was appointed visiting professor of electrical communications at Massachusetts Institute of Technology.

Curtiss-Wright Appoints Christaldi

P. S. CHRISTALDI has been appointed assistant to the general manager of the electronics division of Curtiss-Wright Corp. in Carlstadt, N.J. In his newly-created position, Dr.



P. S. Christaldi

Christaldi will be responsible for the development, manufacture, and sales of highly-specialized nuclear and electronic equipment for both military and commercial uses.

Previous to his new position with Curtiss-Wright, he had been associated with A. B. DuMont Laboratories where he pioneered in cathode-ray tube and cathode-ray



LACING TAPES

lace
harnesses
securely,
permanently,
with no
slipping,
with no
gloves,
with no
trouble.

Gudebrod flat braided lacing tapes hold harness securely—no bite-through or slip, yet are easy on the hands. Some resist high temperature, some are color-coded . . . and they come wax-coated or wax-free . . . rubber-coated . . . or with special coating. Gudebrod makes many tapes for many purposes, including defense work. Send us your lacing problems or your specifications . . . we can supply the answer to both.

**GUDELACE • GUDE-NYLACE
GUDELACE H • TEFLACE**

GUDEBROD BROS. SILK CO., INC.

ELECTRONICS DIVISION

225 W. 34th St., New York 1, N. Y.

EXECUTIVE OFFICES

12 South 12th St., Philadelphia 7, Pa.

Visit Our Booth #4025

On The 4th Floor At The IRE Show

Want more information? Use post card on last page.

March 1, 1957 — ELECTRONICS

oscillograph development. During his career with DuMont, beginning in 1938, he served in such capacities as chief engineer, engineering manager of the instrument division, assistant manager of the division and division manager.

Mallory Names Two Vice-Presidents

G. A. GODWIN and Edward L. Nung were elected vice-presidents of P. R. Mallory & Co. in Indianapolis, Indiana.

Godwin is general manager of the Mallory metallurgical divisions; president of P. R. Mallory Plastics Co. in Chicago and chairman of the board, Electronic Timers Company, Warsaw, New York. Mallory Plastics and Electronic Timers, formerly wholly-owned subsidiaries of P. R. Mallory & Co., Inc., have recently been made divisions of the parent company.

Nung is general manager of the Mallory electronic divisions, with plants in Indianapolis, Frankford and Crawfordsville, Indiana and in Huntsville, Alabama. Prior to joining Mallory four years ago, he had been a plant manager with Sylvania Electric and had been associated with RCA.

Systems Labs Selects Two

JAMES A. MARSH has been appointed vice-president of Systems Laboratories Corp. Richard H. De Lano, secretary of the corporation, had been appointed director of the company's systems integration division.

Before joining Systems Laboratories, Dr. Marsh was radar group leader in the autonetics engineering department of North American. He had the direction of all missile and manned aircraft antenna designs accomplished at the N.A.A. Downey plant.

De Lano has had ten years experience in electronics and radar and was instrumental in the development of the Falcon air-to-air guided missile as senior staff physicist at Hughes Aircraft Corp. He

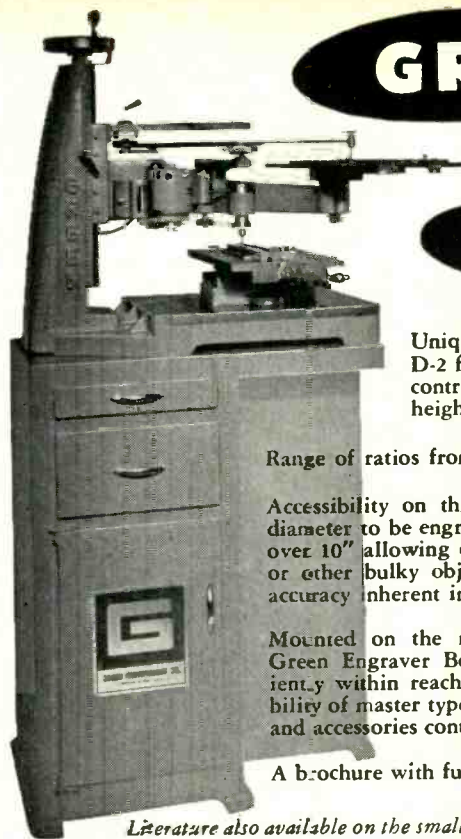

GREEN

Model D-2

Pantograph Engraver

Unique design of the two-dimensional Model D-2 features — Single micrometer adjustment controls vertical depth of cut, and adjusts height of copy table and pantograph.

Range of ratios from 2 to 1 to infinity!

Accessibility on three sides permitting panels up to 30" diameter to be engraved, milled or profiled. Vertical range over 10" allowing operations on complete chassis, cabinets or other bulky objects. Ruggedness, stability and precise accuracy inherent in construction.

Mounted on the ruggedly constructed heavy duty steel Green Engraver Bench. All functional parts are conveniently within reach of the operator while seated. Accessibility of master type sets stored in lower cabinet trays, tools and accessories contribute to productive capacity.

A brochure with full details is yours upon request.

Literature also available on the smaller Model 106 three-dimensional engraver.

GREEN INSTRUMENT COMPANY

363 Putnam Ave., Cambridge, Mass.

PRECISION WAVEGUIDE BENDING

to your specifications
Twists, offsets, fabricated
parts and completed
assemblies.

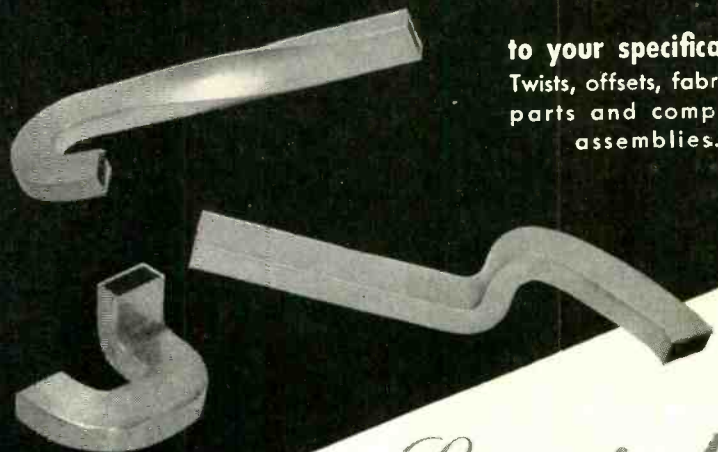

Specialty

AUTOMATIC MACHINE CORPORATION

100 GERRISH AVENUE
CHELSEA 50, MASS.
Telephone CHelsea 3-6160

STROMBERG-CARLSON "BB" Series Relays

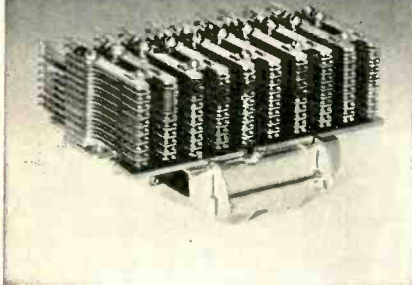

For your automation
...computing...control
circuit applications...
"Telephone Quality"
at an ordinary price

To meet your needs for precision and durability in automation, computing and control circuitry, this relay provides *telephone quality* at an ordinary price.

The "BB" Series Relay accommodates up to 100 Form A spring combinations. It incorporates such important advantages as twin contacts, knife-edge pivot and special frame-armature construction. Like all Stromberg-Carlson relays, it is built to operate under extreme ranges of temperature and humidity. *Prompt delivery is available on all orders.*

This catalogue will give you complete technical details and specifications. We will gladly send you a free copy on request. Please ask for Catalogue T-5000R.



STROMBERG-CARLSON

A DIVISION OF GENERAL DYNAMICS CORPORATION
TELECOMMUNICATION INDUSTRIAL SALES
114 CARLSON ROAD, ROCHESTER 3, N. Y.

Want more information? Use post card on last page.

has conducted theoretical and analytical studies in a wide variety of subjects dealing with radar, missile trajectories, navigation and control systems.

Systems Laboratories Corp. was founded last year as a scientific organization specializing in the research and development of interplanetary space travel. The professional staff has more than doubled in the last eight months.

Stromberg Picks Sonar Head

VICTOR SAVCHUK JR. was appointed head of the sonar group in the research and advanced development department of Stromberg-Carlson.

He was head of the acoustic measurements branch of the U. S. Navy Underwater Sound Laboratory in New London, Conn., before joining Stromberg-Carlson in 1956.

From 1947 to 1949 he served as a staff member in the MIT Acoustics Laboratory and in 1949 became a junior research engineer for the Sanborn Company of Cambridge, Mass. In 1950 he joined the Navy's Underwater Sound Laboratory as an electronic scientist, specializing in electroacoustics.

Varian Names Two Engineers

Two engineers were promoted at Varian Associates.

Forrest Nelson will head up the advanced development group in the instrument division's research department. He joined Varian Associates in 1950, where he has been engaged in product engineering of spectrometers and other instruments.

Robert H. Watson was appointed chief product engineer. He came to Varian in 1955, from Ryan Aeronautical Co., where he was an electronics group engineer.

Technology Instrument Completes Expansion

TECHNOLOGY INSTRUMENT CORP. of Acton, Mass. completed a half-million dollar addition to its modern plant in Acton. This latest plant

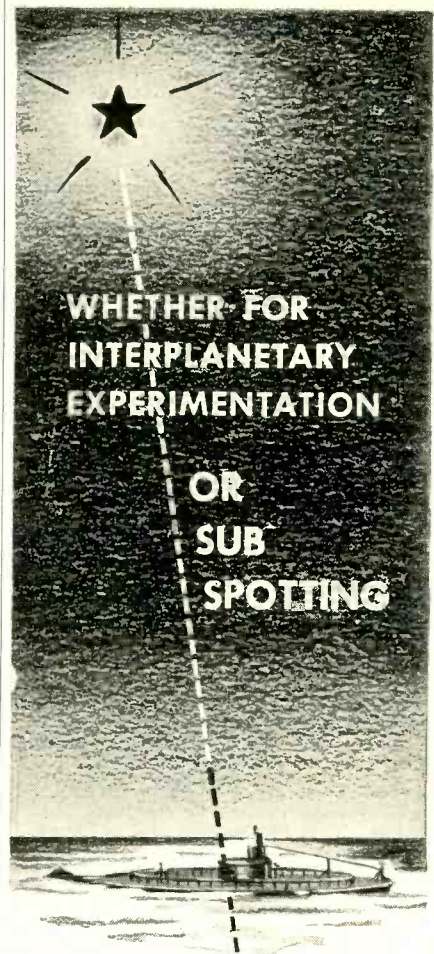

AINSLIE REFLECTORS GIVE ACCURATE PERFORMANCE

Complete coordination of design, manufacture and performance gives permanent reliability to AINSLIE Reflectors. We deliver, from stock, mesh reflectors from 4' diameter to 18'; spun reflectors from 4' to 10'; larger sizes and radar reflectors made on special order to your specifications.

Designed and Manufactured for:

- RADIO-ASTRONOMY
- MICRO-WAVE RELAY
- AIRCRAFT
- MISSILES
- RADAR



Send for our NEW illustrated brochure. Quotations on request without obligation.

We will gladly work with you in the development of any unusual antenna requirements.

Ainslie

CORPORATION

312 QUINCY AVENUE, QUINCY, MASS.
Want more information? Use post card on last page.

March 1, 1957 — ELECTRONICS

PRECISION ATTENUATION to 3000 mc!

**SINGLE "in-the-line"
ATTENUATOR PADS
and 50 ohm COAXIAL
TERMINATIONS**

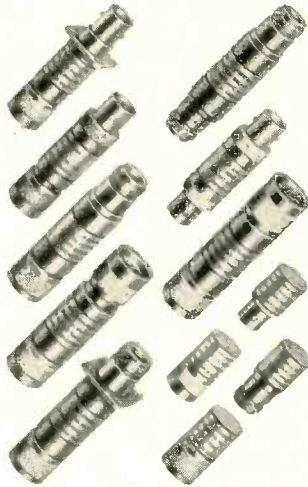

PROTECTED UNDER STODDART PATENTS

This new group of pads and terminations features the popular Types C and N connectors, and permits any conceivable combination of the two styles.

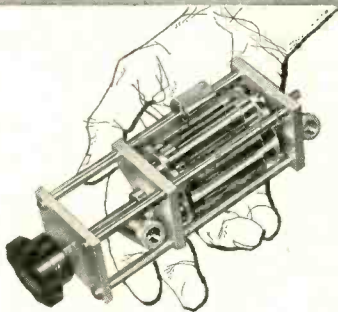

PROTECTED UNDER STODDART PATENTS

six-position
TURRET ATTENUATOR

- Frequency Range: dc to 3000 mc.
- Characteristic Impedance: 50 ohms.
- Available Attenuation: Any value from 1 db to 60 db.
- Accuracy: ± 0.5 db.
- Power Rating: One watt sine wave power dissipation.

STODDART

Aircraft Radio Co., Inc.
6644-A SANTA MONICA BLVD.
HOLLYWOOD 38, CALIF. • HO 4-9294

PLANTS AND PEOPLE

(continued)

expansion is expected to increase production capacity by as much as 100 percent.

The new addition incorporates a filtered air system for control of dust and humidity. It minimizes final-test rejects, speeds production, and provides maximum protection against latent corrosive elements that will affect potentiometer performance in the field, according to the firm.

Delco Appoints Transistor Chief



Frank Jaumot

FRANK JAUMOT was appointed director research and engineering in semiconductors for the Delco Radio division of General Motors.

Dr. Jaumot joins Delco Radio from the Franklin Institute at Philadelphia where he had been chief of physics of metals section.

At the University of Pennsylvania, he taught physics until 1952 when he joined the Franklin Institute. While at the Institute he continued at the U. of P. as an assistant professor of metallurgical engineering.

Filtors Selects Research Director

B. LAZICH has been appointed director of the research and engineering division of Filtors, Inc., manufacturers of sub-miniature hermetically sealed relays.

Prior to joining Filtors, Lazich was senior research engineer at

Precision

PHASE MEASURING INSTRUMENTS

.00001 cps to 500 mc



Type 405, 405H and 405L.
Direct phase measurement from 1 cps to 500 kc. Accuracy .25 degree

Type 205 and 205A—100 kc to 15 mc. Accuracy 0.1° or 1%

Ultra-Low Frequency Phase Angle Counter. Accuracy $\pm 1/2^\circ$ or 1 count per 100,000. Frequency Range: .00001 cps to 1 kc

DELAY LINES

CONTINUOUSLY & STEP VARIABLE, TAPPED and FIXED



Continuously Variable Delay Lines from 0 to over 1000 us with incremental time delay less than 0.5 millimicrosecond. Rise time less than 8% of the time delay.

Step Variable Delay Lines with equal input and output impedance.

Taped Delay Lines with ten or more taps.

Fixed Delay Lines of all types meeting JAN specifications.



ADVANCE

Electronics Lab., Inc.
249-259 Terhune Ave.,
Passaic, N. J.

Visit our Booth
No. 3412 at the Coliseum



ENGINEERS AND MANUFACTURERS

COMPLETE MICROWAVE COMPONENTS

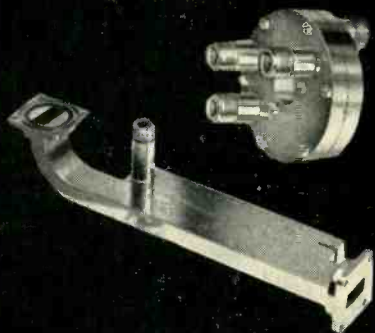

CUSTOM DESIGNS

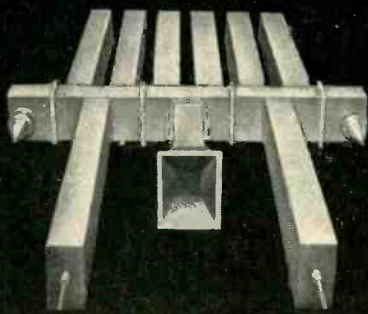

ANTENNA SYSTEMS



TEST EQUIPMENT

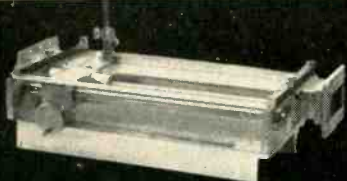

Diamond

ANTENNA & MICROWAVE CORPORATION
7 NORTH AVENUE • WAKEFIELD, MASS.

Want more information? Use post card on last page.

the Robertshaw Research Center in Irwin, Pa., where he specialized in work on electrical and thermostatic control devices.

He has been granted more than 30 United States and foreign patents—with a number still pending—for his developments of relays and other control devices.

University Of Chicago Appoints Biberman

LUCIEN M. BIBERMAN has been appointed by The University of Chicago to the position of director of the electronics division of Chicago Midway Laboratories.

Since 1944 he has been a member of the technical staff of the Naval Ordnance Test Station, China Lake, Calif. He was responsible for the design of the NOTS Aeroballistics Laboratory and for the early Sidewinder seeker design. His most recent work included missile vulnerabilities and countermeasures studies.

At Chicago Midway Laboratories Biberman will be concerned with infrared, optical and electronics projects.

General Telephone Forms Lab Unit

GENERAL TELEPHONE CORP. has formed General Telephone Laboratories in Chicago.

The newly created organization has acquired the research and development personnel and facilities of Automatic Electric Co., principal manufacturing unit of the General Telephone System, and will embark on a greatly expanded program of basic research and product development in the telephone switching and related communication fields. The work of the new laboratories will also extend into all areas of remote control by electronic and electro-mechanical means. The new unit will eventually be housed in new quarters being built in Northlake, Ill.

In addition, the new laboratories will undertake a comprehensive program of quality analysis and

No Brushes

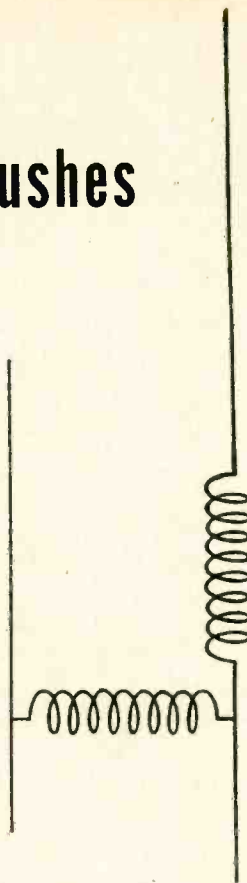

G-E Inductrol* Voltage Regulators Mean Reliability

Because it is an induction regulator, the Inductrol maintains $\pm 1\%$ a-c output voltage *without using brushes.*

This means radically lower maintenance costs than are possible with old brush-commutator type regulators. There are no brush inspection, cleaning, replacing, or stocking problems. There are no commutators to arc over or wear down. General Electric Inductrols mean precise, highly reliable, economical voltage regulation.

For more information, write Section 425-7, General Electric Co., Schenectady 5, N.Y., or contact your nearest General Electric sales office or agent.

*General Electric Trademark for induction voltage regulators.

Progress Is Our Most Important Product

GENERAL ELECTRIC

Want more information? Use post card on last page.

measurement for all units of the General Telephone System.

Robert M. Wopat, Automatic's vice-president in charge of research and engineering, has been elected president of the new organization.

Battelle Names New Director

B. D. THOMAS has been appointed director of Battelle Memorial Institute. He succeeds Dr. Clyde Williams in the management of Battelle's research operations in the United States and Europe.

A member of the Institute's ex-



B. D. Thomas

ecutive and technical staff since 1934, Dr. Thomas was appointed assistant director in 1942. Subsequently, he was named secretary of the Battelle Memorial Institute Corp. and in 1955, he became vice-president.

He established and headed Battelle's first division of chemical research in 1939, and was a key figure in the establishment of Battelle's research laboratories in Frankfurt, Germany, and Geneva, Switzerland, and in the development of the Institute's recently completed Nuclear Research Center.

Daystrom Adds Computer Engineer

ERIC WEISS, formerly senior staff physicist for Hughes Aircraft Co., has joined the engineering staff of Daystrom Systems division of Daystrom. He will concentrate on

TRACER-GUIDED DRILLING

100 HOLES P. M.

WITH NEW HERMES *Engravo* *graph*

Printed circuit plates now accurately drilled by unskilled labor from enlarged template by air activated feed.

See demonstration at
Booth #1234
I.R.E. Show

Ask for catalog H29 describing pneumatic attachment

new hermes ENGRAVING MACHINE CORP.
13-19 University Place, New York 3, N.Y.

Make springs yourself . . . fast, exact!

WITHOUT USE OF ARBORS

For a replacement or experimental spring, any shape, diameter or pitch from flat or round wire sizes .005" to .125", you can produce it in a matter of seconds with Perkins Precision Spring Coiler. You eliminate arbors, yet turn out precision springs — torsion, compression, extension, tapered, or special springs, coiled either

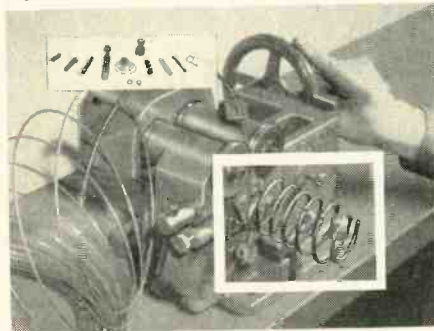

left or right hand, in any desired length, any diameter from 3/32" to 12" and larger, with or without initial tension, and with open or closed ends. Eliminate expensive special orders and costly production delays! Make your own springs to exact specifications as replacements or experimental work. Make them fast, right in your own shop!



Starret adjustable jaw cut nippers (left) and Gardener Hook-Kon spring looping tool (center) — handy, precision, time-saving accessories for spring coiling. Perkins Spring Coiler available as bench model or power model shown here, (right) for tool shop or continuous runs.



Perkins Machine and Gear Co.
Special Machinery Division, Dept. C3
W. Springfield, Mass.
Please send information and prices on Perkins Spring Coiler.
Hand Model Power Model

Name.....Title.....
Company.....
Address.....
City.....State.....

HIGH Sensitivity RELAYS

for Military Equipment
and
Commercial Applications

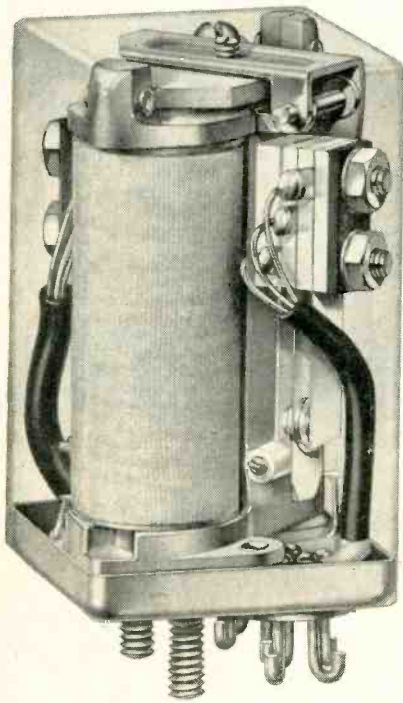

- Meet MIL R-5757C and MIL R-25018 specifications.
- Sensitivity down to 6 mw.
- Coil Resistances to 20,000 Ohms.
- Switching Capacities up to 5a., 28 v., d.c.
- Standard contact arrangements to DPDT.
- Same long life and reliability in relays for commercial applications.

All relays may be purchased in a wide variety of terminals and mounting means to suit most applications.

Early delivery of relays built to standard specifications.

WRITE FOR RELAY DATA BULLETIN



MILWAUKEE GAS SPECIALTY CO.

Dept. RE-1, Milwaukee 1, Wisconsin

Want more information? Use post card on last page.

454

the application and usage of computers in automatic systems.

While with Hughes, Weiss was responsible for the design of large scale, special-purpose military data handling systems. His design and general supervision were responsible for the Northrop's Maddida 44A. His design record also includes Computer Research Corporation's special purpose, high-speed computer, decimal differential analyzer and high-speed printer.

Kaiser Electronics Selects Walden

LLOYD H. WALDEN has been appointed chief engineer of the West Coast electronics laboratory of Kaiser Aircraft & Electronics Corp.

He joins the laboratories at Palo Alto after serving for the past two



Lloyd H. Walden

years as chief electronic scientist for the U. S. Army Signal Corps electronics research unit at Mountain View. There, he supervised technical direction of research and development in the field of electronic countermeasures.

In 1946, he joined the U. S. Navy Electronics Laboratory at San Diego as an electronics engineer, engaged in the development of shipboard electronics equipment.

In 1950, Walden was appointed director of radar equipment de-

beside
yourself?

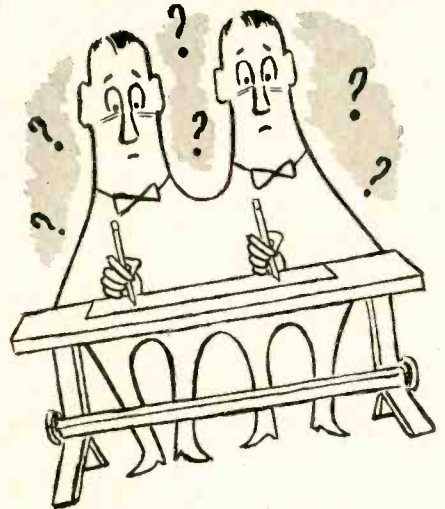

Broad Band amplification problems got you seeing double? Call the guy from I.F.I. His singular ability to dovetail detail with vision and know-how makes him a welcome sight.

I.F.I.'s Model 395 "Super Video" Wide Band Amplifier is designed to provide a bandpass beyond that of a normal video amplifier.

A self contained unit mounted in a cabinet topped with carrying handle, it may be used to increase the sensitivity of a frequency counter. A counter requiring 1 volt to actuate can be used to count a signal as small as 300 microvolts! In the lab it is a most useful factor because its high gain enables it to be driven from a crystal detector, resulting in a wide band crystal video receiver. The power output of signal generators are greatly augmented by its use.

So see the man from I.F.I. who will show you the great advantages in the use of the unit he is proud to represent, I.F.I.'s newest Model 395 "Super Video" Wide Band Amplifier.

SPECIFICATIONS

Bandpass.....	1 Kc to 50 Mc
Gain.....	70 db
Input Impedance.....	90 ohms
Output Impedance.....	90 ohms
Output Voltage Capability	More than 1V. rms
Noise Figure.....	15 db
Tube Complement.....	24-6AK5's 1-5R4-GY
Gain Control provided on front panel	
Rise Time.....	10 millimicro-seconds

P.S. Are you a qualified engineer interested in doubling your possibilities in your chosen field? Don't think twice... Call on us, pull up a chair and we'll talk, in complete confidence, about joining our growing forces at I.F.I.



INSTRUMENTS FOR INDUSTRY, INC.

152 Glen Cove Rd., Mineola, N. Y. • Pioneer 2-5300

See you at I.R.E. Show — Booth #2830

Want more information? Use post card on last page.

March 1, 1957 — ELECTRONICS

NEW! ENGRAVED Rubber Dies and Stamps!

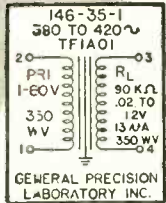

**CLOG
RESISTANT**

**N
20**

**ACID
RESISTANT**

134

**LONGER
LASTING**

● Now you can get clean, clear, sharp, even impressions everytime with Krengel Deep-Kut Engraved Rubber Dies and Stamps. Lasting impressions remain on metals . . . printed materials . . . textiles . . . glass . . . on any surface.

● We make Deep-Kut Engraved Rubber Dies and Stamps for every marking unit . . . any type style or logotypes. Anything you need in any quantity you desire.

Visit our Booth #4020
IRE Show at the Coliseum
March 18-21, 1957

KRENGEL MANUFACTURING COMPANY
227 FULTON STREET, NEW YORK 7, N. Y.
TEL. CO 7-5712

Transistor Circuit Development

An unusual opportunity for an electronics engineer experienced in the application of transistors to digital circuits and to audio, IF, and RF amplifiers; RF oscillators; and power supplies. For use in Scatter, SSB and Digital Military Communications Systems.

Please address inquiries to:
Mr. Frank C. Nagel

**The Ramo-Wooldridge
Corporation**

5730 ARBOR VITAE STREET
LOS ANGELES 45, CALIFORNIA

why you should use **BALTIC** custom built enclosures . . .



Your product in a BALTIC custom built housing has a luxury look. Individually designed to meet your specifications . . . and you can be assured of perfect fit and skilled craftsmanship.

All our products are interchangeable to assure speedy assembly on your production line. Each unit we turn out is accurately engineered to close tolerances and finished to perfection, reflecting our long years as specialists in solving sheet metal fabrication problems. Our large stock of standard and Whistler die combinations eliminates unnecessary tool charges and sends your unit cost way down.

Whether you need simple chassis or enclosures for the most complicated equipment, BALTIC will custom build it . . . in any metal, any size, any gauge, any finish, in large or small quantities. Complete facilities for finishing and shipping all under one roof.

BALTIC METAL PRODUCTS CO.

126 SUTTON ST. BROOKLYN 22, N. Y. • EVergreen 4-2300

NOW AVAILABLE UP THROUGH 1 MEGOHM

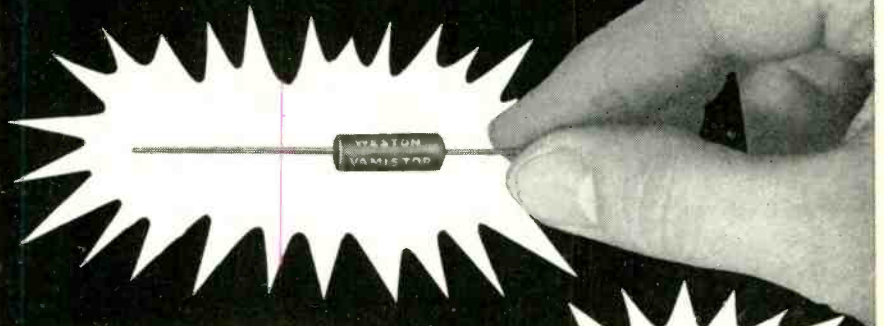

**WESTON
VAMISTORS**
Precision Metal Film Resistors



Weston Electrical Instrument Corp., Newark 12, N. J.

**VISIT
BOOTHS
2907-9
IRE SHOW**

GE SAVES 80%

with **GRC**
tiny mating
parts

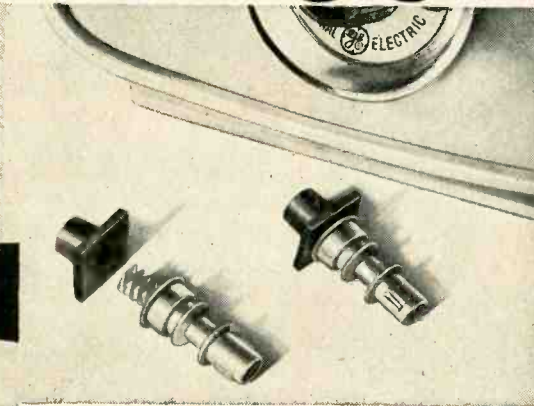

Exclusive Gries techniques actually improved design and performance by die-casting this zinc-alloy threaded shaft and injection-molding the mating Nylon nut. Both units formerly were produced as screw machine parts, at 5 times the present cost. A typical demonstration of GRC's unique talent for doing big things with small parts . . . economically!

Send today for samples and bulletin

GRIES REPRODUCER CORP.

151 Beechwood Ave., New Rochelle, N. Y. NE 3-8600

**NO MINIMUM SIZE!
MAXIMUM SIZES:**

Nylon 1 1/4" long .03 oz.
Zinc Alloy 1 3/4" long 1/2 oz.

Quick deliveries on quantities
of 100,000 to many millions

GRIES

World's foremost
producer of
small die castings

PLANTS AND PEOPLE

(continued)

velopment at the Navy Laboratory and supervised design of a number of radar equipments for the Navy and Marine Corps.

Convair Adds Two Engineers

Two electronics engineers have been added to the staff of Convair, division of General Dynamics Corp. in San Diego.

They are John P. Day, engineering staff specialist, who will coordinate research activities in the fields of antennas, radomes and microwaves; and Forrest E. Huggin, design specialist, who will coordinate research in advanced electronic systems and servomechanisms.

Day was with the Naval Electronics Laboratory in San Diego for 11 years and was also at National Aircraft Corp., San Diego, and Lockheed Corp., Los Angeles. He has been an engineering instructor at the University of California for the last six years.

At NEL he headed the instrumentation section of the research division.

Huggin held several key electronics positions in a civilian capacity with the Navy and with Lockheed's missile systems division as radar section chief. His Navy work included the development of pulse command guidance systems of Navy missile use and cathode-ray indicators for nuclear weapon tests.

AIEE Nominates New President

WALTER J. BARRETT, New Jersey Bell Telephone Company engineer, has been nominated to be president of the American Institute of Electrical Engineers. Five vice-presidents and three directors were also nominated.

Barrett, who is transmission engineer of New Jersey Bell will serve as 1957-58 president of the Institute which has a world-wide membership of 51,000. He has been president of United Engineering Trustees, Inc., since 1955. He has been with the Bell System since his graduation from the Polytechnic

BOOTHS
2428-2521
IRE SHOW

PRECIOUS METAL WIRES

Produced in Platinum, Gold, alloys and pure metals—small diameter . . . Platinum alloy resistance wires . . . Pure Iridium and Rhodium-Iridium alloy Thermo-couple Wire.

*Metallurgists and Specialists
in SMALL WIRE for 56 Years*

BASE METAL WIRES
Very small diameter—
for filaments,
thermo-couples, re-
sistance units.

Since 1901

COATED WIRES

Comprising an extensive range of electroplated grid wires . . . Enamel insulated wires for precision resistors and potentiometers.

Write for List of Products



SIGMUND COHN CORP. 121 So. Columbus Avenue • Mount Vernon, N.Y.

**BE HAPPY...
...GO BERKELEY!**

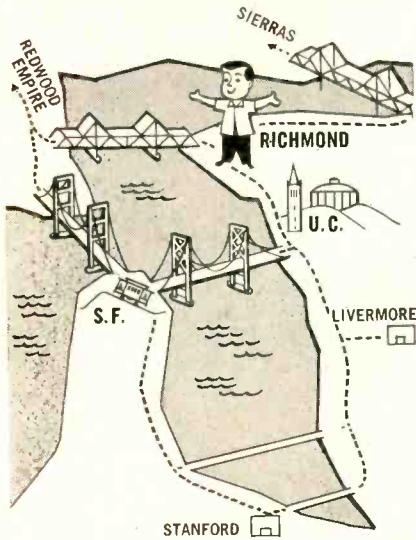

If you've looked around much for a new job, you know some companies solemnly offer you the moon on a silver platter. At Berkeley, we're fresh out of moons. But we can deliver something you won't find everywhere—a first-rate place to work and live. You can relax here and find satisfaction in your work. Nobody breathes down your neck—all the stuffed shirts were kicked out long ago. This is a fast-growing company, and you'll have plenty of responsibility and a chance to move ahead rapidly. Our engineers work in new, comfortable quarters, completely equipped for research and development. You'll be paid well, share in the profits, and receive many other benefits. Most of all, though, you'll be happy you made the change.

We shouldn't have to say much about the San Francisco Bay area. If you like living, you ought to try it here. Our plant in Richmond is just 22 minutes from the nearest cable car.

Basically, we're looking for effective electronic circuit designers. We need analog computer design engineers, computer applications engineers, field engineers with troubleshooting experience, industrial systems engineers, and electronic technicians. We also need men with experience in new techniques, such as transistors or magnetics, and in such specialties as microwave, uhf, nuclear radiation detection.

For details, write or phone:

HARRY MCELROY,
Personnel Director

Berkeley *division*
BECKMAN INSTRUMENTS INC
RICHMOND 3, CALIF. • LANDSCAPE 6-7730

Want more information? Use post card on last page.
ELECTRONICS — March 1, 1957

Institute of Brooklyn in 1920. He has served as the AIEE treasurer since 1953.

**Sperry Award
Goes To Jude**



George F. Jude

THE Institute of Aeronautical Sciences awarded the Lawrence B. Sperry Award to George F. Jude, director of flight control engineering at the Sperry Gyroscope Co.

The citation reads: "for significant contribution to the advancement of precision automatic flight and safe all-weather flying."

Jude's achievements, since joining Sperry in 1942, were climaxed last year when he led a team of engineer-scientists to successful development of the SP-30, an electronic system for controlling jet airliners in flight.

**Thiokol Acquires
National Electronics**

NATIONAL ELECTRONICS LABORATORIES of Washington, D. C., has been acquired by Thiokol Chemical Corp.

National will operate as a wholly-owned subsidiary under its present name.

Thiokol is engaged in the manufacture of special purpose synthetic rubber and special chemicals. It operates plants in Trenton, N. J. and Moss Point, Miss.

It also operates plants for the research, development and manufacture of solid propellant engines for rockets and guided missiles for



Type MR Rack Mounted

DIRECT WRITING OSCILLOGRAPH

unequaled for versatility and performance!

- ... **rectilinear recording**
- ... **curvilinear recording**
- ... **heat sensitive recording**
- ... **electric recording**
- ... **ink recording**
- ... **15/μv/mm d-c sensitivity**
- ... **zero drift**

**IN A SINGLE
RECORDER!**

Write for 12 page, 2 color catalog—
gives details and specifications.



**OFFNER
ELECTRONICS**

5324 N. KEDZIE AVE. • CHICAGO 25, ILL.
On exhibit at the IRE Show—Booth 3051

Want more information? Use post card on last page.

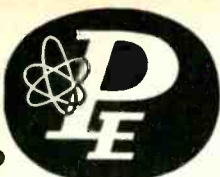

has
a complete
stock of

UG
connectors

RG
cables

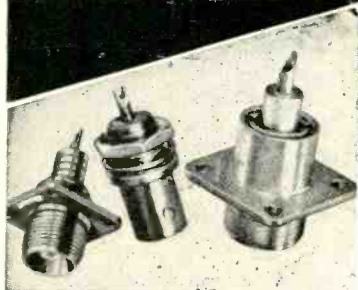

Largest Inventory in the Industry,
Orders Shipped the Same Day. All
Jan. Spec. Approved Components. Deal
with PROGRESS to Save Time and
Money.

Just off press—in our new catalog,
you will find a quick and easy reference
to determine what connectors and cables
should be specified for each application.

From this catalog you can also easily
determine what mating connectors
should be used to adopt between different
series of connectors.

Mail, Wire, Call
WOrth 2-8041

**PROGRESS
ELECTRONICS CO.**

296 Broadway, New York 7, N. Y.

GENTLEMEN:

Please send at once your Catalog P-7, illustrating and describing Coaxial Connectors, Cables, Plugs and Jacks.

NAME

FIRM

ADDRESS

CITY STATE

Want more information? Use post card on last page.

the government at Redstone Arsenal, Huntsville, Ala. and Longhorn Ordnance, Marshall, Texas. It has its own operations for similar projects at Tremonton, Utah, and Elkton, Md.

National Electronics Laboratories has been active in the electronic field since 1946, specializing in instrumentation and communications for the U. S. Government and industry.

Ace Appoints New Division Heads

ACE Electronics Associates of Somerville, Mass. appointed William Lyon and Abraham Osborn to head up the newly formed precision nonlinear potentiometer division. Both have had experience in nonlinear potentiometer design and application.

Lyon was formerly a design engineer with Technology Instrument Corp. for four years. He supervised the electrical engineering department and was responsible for the development of the techniques required in the design of nonlinear potentiometers.

Osborn was with Technology Instrument Corp. for three years on design and application engineering of precision potentiometers. His experience also includes engineering with Fenwal Laboratories, Picker X-Ray, General Radio, and the U. S. Signal Corps.

Du Mont Selects Display Manager

ROBERT W. DEICHERT has been named manager of the newly formed data and display department of A. B. Du Mont Labs.

He will be responsible for development work in the application of data and display techniques to electronic equipment.

Immediately prior to his promotion, Deichert served as head of the division's data equipment development section. He joined Du Mont in 1951 and has been active in the



Mr. Slydruhl took an abrupt Eternity Leave... but he was about to say the Autron PE unit is the smallest made in the U.S.... about the size of a thimble. Since he plans (pardon us, planned) to use many of these in his complex Control system, he is (Rest In Peace, was) glad they cost only \$10.65 each. This shockproof unit complete with cable, needs nothing put in but light. If you have a complex control problem, inspect it... preferably away from your Punch Press. We want to KEEP our customers.

The model 6350 Miniature Photo-Electric Detector is an ultra-miniature element of high sensitivity and extremely rugged construction. Its small size makes it valuable when space is at a premium. The unit will provide 300 MV at 100 FC into 1 megohm or 20 MA at 100 FC into 100 ohms.

Write today for further information on this unit and its companion Model 6375 Miniature Light Beam Projector and other units in our line of reliable control devices. Write to

Mr. E. Edwards,

Autron



ENGINEERING, INC.
1254 WEST SIXTH STREET
LOS ANGELES 17, CALIF.

Want more information? Use post card on last page.

March 1, 1957 — ELECTRONICS

ZOPHAR

---WAXES

---COMPOUNDS

Zophar Waxes, resins and compounds to impregnate, dip, seal, embed, or pot electronic and electrical equipment or components of all types; radio, television, etc. Cold flows from 100°F. to 285°F. Special waxes non-cracking at -76°F. plain or fungicidal. Let us help you with your engineering problems.

For immediate service contact:

L. E. Mayer, Sales Manager
A. Saunders, Technical Director
H. Saunders, Chemical Laboratory
Phone 50uth 8-0907



ZOPHAR MILLS, INC.
112-130 26th Street,
Brooklyn 32, N. Y.

FOR MARKING...



**PLASTIC • METAL
GLASS • PAPER
RUBBER • CERAMIC
CARDBOARD**

In such products as Resistors, capacitors, valves, tubes, labels, sleeves, spark plugs, cartons, etc., etc.

THESE PRODUCTS AND MANY OTHERS OF ALMOST ANY MATERIAL AND SHAPE CAN BE IMPRINTED

ON THE

REJAFIX MARKING MACHINE

Why not send us samples of your products? They will be test-printed and returned to you for your examination!

- REJAFIX HAND-OPERATED MODELS FOR SMALL RUNS. FULLY AUTOMATIC MODELS FOR MASS PRODUCTION.

EST. 1922

POPPER & SONS INC. 300 FOURTH AVENUE
NEW YORK 10, N. Y.

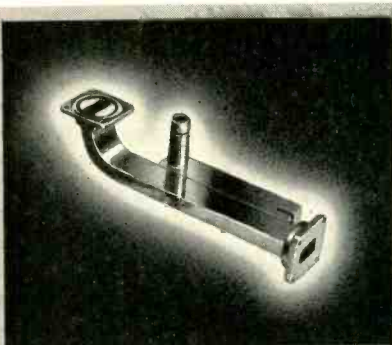

MICRO-WAVE AND COAXIAL COMPONENTS

By **UNIWAVE**

- Attenuators and terminations
- Crystal mounts and mixers
- Filters
- Directional couplers
- Power dividers
- Adjustable shorts
- Dummy loads and antennas
- Wavemeters

UNIWAVE'S SPECIALIZED FACILITIES

UNIWAVE has engineering and manufacturing facilities particularly suited to the production of special microwave and coaxial components. In both personnel and equipment UNIWAVE is attuned to the precision and consistent quality requirements of these components.

For further information contact —

UNIWAVE, INC.

2 Marine Street
Farmingdale, N. Y. — Tel. CHAPEL 9-8180

NEW AMCI AUTOMATIC IMPEDANCE PLOTTER

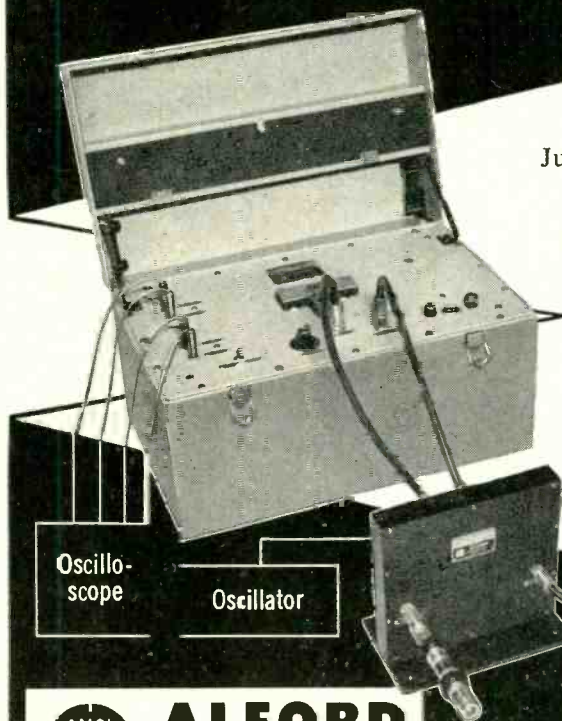

*For Lab or
Production Testing*

Just turn the oscillator dial, manually or by a motorized sweep drive, and the impedance curve of load Z is traced on a regular or an expanded Smith chart.

Either an oscilloscope or a two-axis recorder can be used.

*See this equipment
in operation at
Booth 1623,
I.R.E. Show*

Oscillo-
scope

Oscillator

Load "Z" to
be measured



ALFORD

Manufacturing Co., Inc.
29° ATLANTIC AVE., BOSTON, MASS.

Model 11-P 200 mc — 960 mc.
Model 11-Q 30 mc — 400 mc.

INSTRUMENTS — ANTENNA SYSTEMS — COMPONENTS — AIR-NAVIGATION AIDS

the specs are the proof . . .
the BEST BUYS are **EICO**[®]
for COLOR & Monochrome TV servicing



NEW COLOR
and Monochrome
DC to 5 MC LAB & TV
5" OSCILLOSCOPE

= 460
Factory-wired
and tested \$129⁵⁰
Also available as kit \$79⁹⁵

• Features DC Amplifiers!

Flat from DC-4.5 mc, usable to 10 mc. VERT. AMPL.: sens. 25 rms mv/in; input Z 3 megs; direct-coupled & push-pull thruout; K-follower coupling bet. stages; 4-step freq-compensated attenuator up to 1000:1. SWEEP: perfectly linear 10 cps-100 kc (ext. cap. for range to 1 cps); pre-set TV V & H positions (30 & 7875 cps); auto. sync. ampl. & lim. PLUS: direct or cap. coupling; bal. or unbal. inputs; edge-lit engraved lucite graph screen; dimmer; filter; bezel fits std photo equip. High intensity trace CRT. 0.06 usec rise time. Push-pull hor. ampl., flat to 400 kc, sens. 0.6 rms mv/in. Built-in volt. calib. Z-axis mod. Sawtooth & 60 cps outputs. Astig. control. Retrace blanking. Phasing control.



NEW TV-FM
SWEEP GENERATOR
& MARKER

= 368
Factory-wired
and tested \$119⁹⁵
Also available
as kit \$69⁹⁵

Entirely electronic sweep circuit (no mechanical devices) with accurately-biased incedrnetor for excellent linearity. Extremely flat RF output: new AGC circuit automatically adjusts osc. for max. output on each band with min. ampl. variations. Exceptional tuning accuracy: edge-lit hairlines, 6:1 vernier. Swept Osc. Range 3-216 mc in 5 fund. bands. Variable Marker Range 2-75 mc in 3 fund. bands; 60-225 mc on harmonic band. 4.5 mc Xtal Marker Osc., xtal supplied. Ext. Marker provision. Sweep Width 0-3 mc lowest max. deviation to 0-30 mc highest max. dev. 2-way blanking. Narrow range phasing. Attenuators: Marker Size, RF Fine, RF Coarse (4-step decade). Cables: output, 'scope horiz., 'scope vertical.

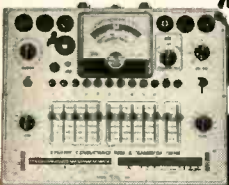

NEW DYNAMIC
CONDUCTANCE
Tube &
Transistor Tester

= 666
Factory-wired
and tested \$109⁹⁵
Also available
as kit \$69⁹⁵

COMPLETE with steel cover and handle.

SPEED, ease, unexcelled accuracy & thoroughness. Tests all receiving tubes (and picture tubes with adapter). Composite indication of Gm, Gp & peak emission. Simultaneous sel of any 1 of 4 combinations of 3 plate voltages, 3 screen voltages, 3 ranges of continuously variable grid voltage (with 5% accurate pot). New series-string voltages: for 600, 450, 300 ma types. Sensitive 200 ua meter. 5 ranges meter sensitivity (1% shunts & 5% pot). 10 SIX-position lever switches: free-point connection of each tube pin. 10 push-buttons: rapid insert of any tube element in leakage test circuit & speedy sel. of individual sections of multi-section tubes in merit tests. Direct-reading of inter-element leakage in ohms. New gear-driven rollchart. Checks n-p-n & p-n-p transistors: separate meter readings of collector leakage current & Beta using internal dc power supply.

See the 50 EICO models IN STOCK at your neighborhood distributor. Write for FREE Catalog E-3

Prices 5% higher on West Coast

EICO[®] BROOKLYN 11, N. Y.

Want more information? Use post card on last page.

division's work in multiplier phototube evaluations, color tv studio equipment and other special projects.

For three and a half years previous to joining the company, Deichert was an instructor of electrical engineering at Pratt Institute's School of Engineering in Brooklyn, New York and at Stevens Institute of Technology in Hoboken, N. J.

Arvin Promotes Three Engineers

JOHN J. CROUCH, former manager of the electric appliances plant of Arvin Industries in Columbus, Ind., has been named director of engineering in the firm's electric appliances department.



John J. Crouch

John P. Sohn, former assistant chief engineer, now is chief engineer for the department, and Eugene E. Ball, who has been factory superintendent, succeeds Crouch as plant manager.

J. Robert Munn, who has been manager of the radio plant in the electronics and appliances division, has been named plants manager of both the radio and electric appliance factories. Francis M. Crockett has been promoted to manager of the radio factory.

Crouch joined Arvin as a radio

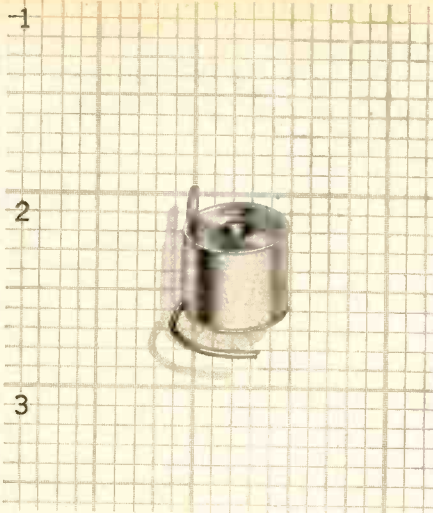

miniature coils withstand 500° F. plus

TUR-BO JET PRODUCTS CO. now custom-winds relay type coils that operate efficiently at -90° to +500° F. ambients. This unprecedented temperature range is made possible by 100% Teflon* construction. Coils are non-gassing. (U. S. Pat. applied for)

Any size down to sub-miniature is feasible. We use Teflon wire as small as #50 AWG.

More ampere turns. Tur-Bo Jet's new coil design establishes a new maximum—previously unattainable—in space factor. This enables us to get more copper onto a winding without increasing your present dimensions. In most cases, we can give you more ampere turns than you are now getting.

Write for bulletin HT. Or send us your specifications.

Tur-Bo Jet also winds to class A, B, H and C requirements.

*DUPONT TRADEMARK

tur-bo jet

products co., inc.

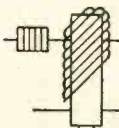

424 S. San Gabriel Blvd.
San Gabriel, Calif.

SEE OUR BOOTH 3924 I.R.E. Show

Want more information? Use post card on last page.

engineer in 1933. He became radio and television factory manager in 1950. He was transferred to the electric appliances department in 1952 as plant manager.

IRE Sets Technical Papers For 1957 Convention

Following is the complete list of technical papers and program events to be presented at the 1957 IRE National Convention in New York City on March 18-21:

Monday Afternoon, March 18

NONLINEAR CONTROL SYSTEMS
Nonlinear Compensating Networks for Feedback Systems for E. Mishkin and J. G. Truxal.

Direct Synthesis through Block Diagram Substitutions by O. J. M. Smith.

A Nonlinear Control System for Wide Range Input Signals by J. Tou and Y. H. Ku.

Switching Discontinuities in Phase Space by J. C. Hung and S. S. L. Chang.

Nonlinear Techniques Applied to the Analysis of Pilot Induced Oscillations by I. Van Horn.

VEHICULAR COMMUNICATIONS

How Far Can We Go in Narrowing Channels in the Land Mobile Radio Services— by C. B. Plummer.

Practical Modern Network Theory Design Data for Crystal Filters by M. Dishal.

Recent Developments in Mobile Radio in Britain by J. R. Brinkley.

A Manually Operated Demand Repeater for the 450-470 MC Band by S. F. Meyer.

Sinad Interference Evaluation by Vosim by N. H. Shepherd.

PROPAGATION

The Refractive Index of the Atmosphere as a Factor in Tropospheric Propagation Far Beyond the Horizon by R. E. Gray.

Attenuation and Fluctuation of Millimeter Radio Waves by C. W. Tolbert and A. W. Straiton.

New Evidence of Anomalous Trans-equatorial Ionospheric Propagation by O. G. Villard, Jr., S. Stein, and K. C. Yeh.

Foreground Terrain Effects on Overland Microwave Transmissions by L. G. Trolese.

Mountain Obstacle Measurements by R. E. Lacy.

Passive Repeater Using Double Flat Reflectors by R. F. H. Yang.

ULTRASONICS ENGINEERING

1—AN EDUCATIONAL SESSION

(In Cooperation with the Acoustical Society of America)

The Training of an Ultrasonic Engineer by F. V. Hunt.

Ultrasonic Analysis by T. F. Hueter.
Some Fundamentals of Transducer Design for the Sonic and Ultrasonic Range by F. Massa.

The Ethics, Standards, and Objectives of the Recently Formed Ultrasonics Manufacturers Association by S. R. Rich.

AERONAUTICAL ELECTRONICS

A New Aircraft Static Discharger by R. L. Tanner.

Thermal Design of Commercial Airborne Electronic Equipment by H. M. Passman.
The New Look in Electronic Controls by R. J. Meyer.

Field Test Equipment for Airborne Radar by W. W. Keith and F. E. Sears III.

Hazardous Environmental Factors and Effects Related to the High-Supersonic-Speed Bomber Defense Program by I. Katz.

MULTIPLEX COMMUNICATIONS SYSTEMS

Signal Mutilation and Error Prevention on Short-Wave Radio-Telegraph Serv-

KULKA ELECTRICAL WIRING DEVICES

Designed for Performance and Economy

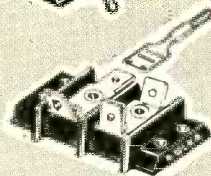
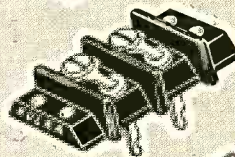
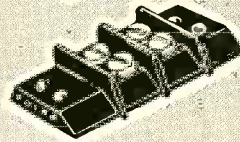
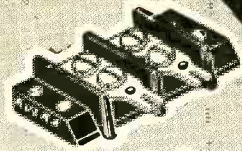

TERMINAL BLOCKS (Left): Large line of molded, barrier type, in varied sizes, materials, and terminals. New "KLIPTITE" style (left bottom) with angled tabs made for AMP, self-locking wire terminals.

TOGGLE SWITCHES (Below): Aircraft type, Single and Double Pole. Bakelite housing. Screw terminals or soldering lugs. One-hole mounting. DC, or AC up to 1600 cycles.

POWER OUTLETS (Below, right): Smallest made for standard plug. Mounts from top or bottom of bracket. Soldering terminals or wire leads. Write for complete Catalog

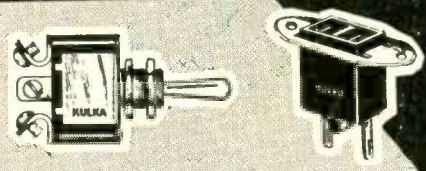

KULKA ELECTRIC MFG. CO., Inc.

633-643 SO. FULTON AVE. • MOUNT VERNON, N. Y.

See our exhibit—IRE—Booth 2901—Second Floor

NEW 1957

MINIATURE TRANSFORMER CATALOG

HUNDREDS OF MINIATURE TRANSFORMERS AVAILABLE OFF THE SHELF

NEW

TRANSISTOR TRANSFORMERS

Approved MIL-T-27A designs

HERMETIC, MOLDED, OPEN OR CASED SERVO, MISSILE, AIRBORNE TYPES

Write for Detailed 1957 Catalog

MICROTRAN

company, inc.

145 E. Mineola Avenue, Valley Stream, L. I., New York

IMMEDIATE DELIVERY AT AUTHORIZED STOCKING DISTRIBUTORS

California, Oakland
W. D. Brill Company

California, Los Angeles
Graybar Electric Co.

Connecticut, Hartford
Moses Radio Electronics Co.

District of Columbia, Washington
Kenyon Radio Supply Co.

Massachusetts, Cambridge
Electrical Supply Corp.

New York, Jamaica
Peerless Radio Distributors

New York, Utica
Wolmar Distributors

Pennsylvania, Philadelphia
Harold H. Powell Company

Texas, Beaumont
Montague Radio Supply

Washington, Tacoma
C & G Radio

only from the leader

trio

New BUILD-IN panel-mounting miniature DC VTVM



\$84⁵⁰

trio

...specializing in miniature electronic instruments

One of a wide variety of panel-mounting instruments, new Model F features higher accuracy, 2% . . . ranges from 0.5 volt zero-center to 300 volts full scale . . . zero adjustment while connected to circuit . . . 10 megs input Z . . . completely self-contained, operates from 60 or 400 cycle 115 V . . . Choice of zero-center or zero-left models . . . Ruggedized MIL version available. Write for free complete catalog to Dept. E-3 Trio Laboratories, Inc., Seaford, New York.

See us at Booth M-6, IRE Show

ices by J. B. Moore.
Time Division Multiplex System with Addressed Information Packages by R. Filipowsky and E. Scherer.
A New Time Division Multiplex system by W. J. Bieganski and L. M. Glickman.
48-Channel PCM System by S. M. Schreiner and A. R. Vallarino.
Portable Multichannel 11,000 MC Radio Link by H. Engelmann, H. A. French, M. W. Green, and J. Harvey.

INFORMATION THEORY: CODING AND DETECTION

Optimum Decision Feedback Systems by B. Harris, A. Hauptschein, and L. S. Schwartz.
Sequential Decoding for Reliable Communications by J. M. Wozencraft.
A Non-Mean-Square Error Criterion for the Synthesis of Optimum Sampled-Data Filters by A. R. Bergen.
Message Redundancy vs Feedback for Reducing Message Uncertainty by W. B. Bishop and B. L. Buchanan.
The Analysis of Post Detection Integration Systems by Monte Carlo Methods by R. Dilworth and E. Ackerlind.

SOLID STATE DEVICES

A New High Frequency N-P-N Silicon Transistor by A. B. Phillips and A. M. Intrator. Noise Figures in Semiconductor Dielectric Amplifiers by J. M. Walker, R. E. Smith, and E. M. Williams.
Determination of Thermal Resistance of Silicon Junction Devices by H. C. Lin and R. E. Crosby, Jr.
An Alloy Type Medium Power Silicon Transistor by H. G. Rudenberg and G. Franzen.
A New Semiconductor Device by C. A. Aldridge.
Cadmium Sulfide Photocapacitors by F. Gordon, Jr. P. A. Newman, J. Hamden, H. Jacobs, and A. Ramsa.

Tuesday Morning, March 19

AUTOMATIC CONTROL—GENERAL

Digital Controllers for Feedback Systems by J. R. Ragazzini.
Sampling in Linear and Nonlinear Feedback Control Systems by J. Kukul.
The Role of Automatic Control in the Modification of Aircraft Dynamic Flight Characteristics by W. N. Turner.
Solution of Statistical Problems by Automatic Control Techniques by R. L. Cosgriff.
Design of Optimum Filters and Predictors by C. W. Steeg.

NAVIGATION

A Realistic Radar Clutter Simulator by J. Atkins, H. J. Bickel, and M. R. Weiss.
A Precision Multipurpose Radio Navigation System by W. N. Dean, R. L. Frank, and W. P. Frantz.
Some Final Approach System Requirements for High Landing Rates by F. H. Battle, Jr. General Characteristics of a 1000 MC Instrument Landing System by A. Casabona.

NEW BROADCAST DEVELOPMENTS

An Analysis of Packing Density of Information in High-Velocity Transverse Video Magnetic Recording by W. Selsted.
High-Light Aperture Equalizer, by M. V. Sullivan.
Single Sideband Broadcast Developments by L. Kahn.
UHF High-Power Transmitting Developments by J. E. Young, L. L. Koros, and I. Martin.
A Dynamic Standard Signal for Color Television Systems by R. C. Kennedy.

ULTRASONICS ENGINEERING II—TECHNICAL SESSION

Sea Clutter in Radar and Sonar by R. M. Hoover and R. J. Urick.
Transducer Comparison Methods Based on the Electromechanical Coupling Coefficient Concept by R. S. Woollett.
Polarization of Barium Titanate Ceramic by J. G. Froemel.
Ultrasonic Liquid Level Sensor by R. L. Rod.
Precision Calibration of Ultrasonic Fields by Thermoelectric Probes by W. J. Fry and F. Dunn.
New Magnetostriction Filters for the MF Band by R. T. Adams.

ENGINEERING MANAGEMENT VIEWPOINTS

Education: Academic Training for Engineering Management by E. Shapiro.
Finance: Wall Street Looks at Engi-

Engineers who know
—SPECIFY

Q-max

A-27 SUPERFINE LOW-LOSS RF LACQUER

*Registered
Trademark

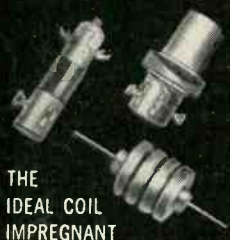

THE
IDEAL COIL
IMPREGNANT

• Q-Max, an extremely low loss dielectric impregnating and coating composition, is formulated specifically for application to VHF and UHF components. It penetrates deeply, seals out moisture, provides a surface finish, imparts rigidity and promotes stability of the electrical constants of high frequency circuits. Its effect upon the "Q" of RF windings is practically negligible.

• Q-Max applies easily by dipping or brushing, dries quickly, adheres well; meets most temperature requirements. Q-Max is industry's standard RF lacquer. Engineers who know specify Q-Max! Write for new illustrated catalog.

COMMUNICATION PRODUCTS COMPANY • INC
MARLBORO, NEW JERSEY—Telephone: FReehold 8-1880



Pacific Coast Branch: 120 SANTA BARBARA ST., SANTA BARBARA, CAL.—Woodland 2-1712-4

Designers
Manufacturers
MIL-P-7788
PANELS-DIALS

— • —
Specialists
INTEGRAL LIGHTING
OF INSTRUMENTS
AND METERS

— • —
Authorized
LIGHT TESTING
Facility of Bu-Air

Write for Engineering Bulletin 73E

BODNAR INDUSTRIES
238 Huguenot St.
New Rochelle, N. Y.
Telephone: NE 6-4664

See Us At Booth 4051—IRE Show

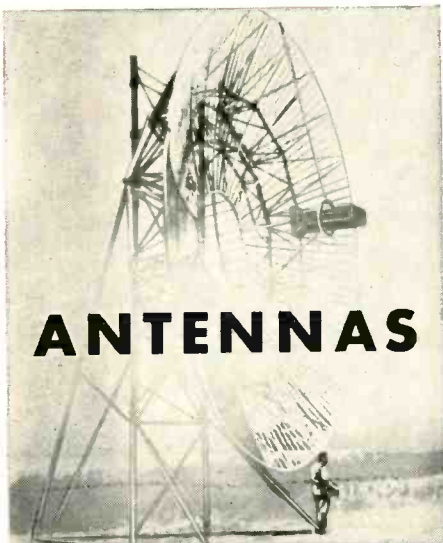

ANTENNAS

Antennas for every need: airborne, telemetering, point-to-point, glide path, and dishes ranging from 4' to 60'. Design development and manufacture of antennas is our business. Send for technical catalog...

BOOTH 1428 AT
New York IRE Show

TAVCO
TECHNICAL APPLIANCE CORPORATION
SHERBURNE, N. Y.

HIGH SPEED DIRECT DRIVE *Gearless* BOBBIN WINDER Adjustable Winding Length

Gears eliminated by new pitch selector; no gear changing between jobs required. Merely set selector lever at desired pitch and wind all types of random wound bobbin coils, solenoids, repeater and relay coils up to 2" OD using 27 to 46 gauge wire.

66-700 turns per inch winding range. Speeds up to 8000 RPM obtained by direct drive between motor and spindle. Fine wire breakage prevented by 3-second slow-start which is dialed in or out as needed. 3½" max. traverse for any single continuous winding. Winding traverse infinitely adjustable between ⅛" and 3½". Max. loading distance for multiple winding 8½". Output end of spindle ½", flatted shaft.

Time-saving fingertip re-settable wire guide permits instant re-setting to identical starting point after completing each winding cycle. Time-saving single shot lubrication permits instant, clean lubrication of all high speed bearings by simply lifting plunger. Tension, pre-determining automatic counter, magnetic brake and positive locking compression-type tailstock furnished.

Save time, increase production, lower costs with Model 312-AM.

GEO. STEVENS MANUFACTURING CO., INC.
Pulaski Rd. at Peterson, Chicago 30, Ill.
The most complete line of coil winding equipment made

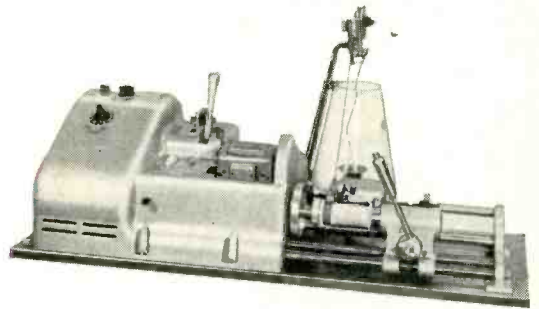

*Looking
for*

TEST LEADS OR CLIPS

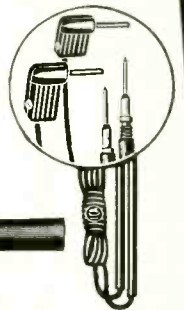

You can rely on the man from Insuline to meet your specific requirements for test leads or clips. Insuline's volume-produced standard or special design components are known for their quality workmanship. Orders filled promptly.

Ask the man from

insuline
CORPORATION OF AMERICA

186 Granite St., Manchester, N. H.

(Van Norman Industries, Inc.)



by
every
test

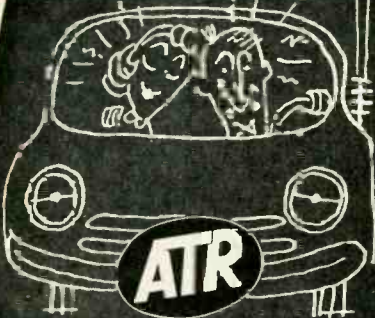

is BEST!



ATR AUTO
RADIO
VIBRATORS

Have Ceramic Stack Spacers
A COMPLETE LINE
OF VIBRATORS

Designed for Use in Standard
Vibrator-Operated Auto Radio
Receivers. Built with Precision
Construction, featuring Ceram-
ic Stack Spacers for longer
lasting life. Backed by more
than 22 years of experience in
Vibrator Design, Develop-
ment, and Manufacturing.

Free

"A" Battery Eliminators, DC-AC
Inverters, Auto Radio Vibrators



NEW MODELS

NEW DESIGNS

NEW LITERATURE

See your jobber or write factory

AMERICAN TELEVISION & RADIO CO.
Quality Products Since 1931
SAINT PAUL 1, MINNESOTA—U. S. A.

Want more information? Use post card on last page.
464

Engineering Management by O. C. Roehl.
Industry: Development of Engineering
Managers With Industry by E. I. Greene.
ANTENNAS I—GENERAL
On Ferrite Loop Antenna Measurements
by J. L. Stewart.
Ground Antenna Phase Behavior in a
Differential Phase Measuring System by
I. Carswell and C. Flammer.
Limits on the Information Obtainable
from Antenna Systems by W. White.
Antenna Problems in Radio Astronomy
by R. N. Bracewell.
High Altitude Breakdown Phenomena
by J. Ashwell, E. B. Cole, A. Pratt, and
D. Sartorio.

**INFORMATION THEORY:
REVIEW AND RECENT
ADVANCES**
Cost of Transmission Reliability by
R. M. Fano.
Channel Capacity Without Coding by
P. Elias.
Coding a Television Source by J. L.
Kelly, Jr.
What Good is Information Theory to
Engineers? by J. R. Pierce.

**Tuesday Afternoon
MICROWAVE TUBES**
The Selection and Applications of
Traveling-Wave Tubes by A. H. Nielsen
and N. W. Hansen.
X-Band Traveling-Wave Tube Feedback
Oscillator by V. G. Price.
A Light-Weight, Low-Level Traveling-
Wave Tube Amplifier for S Band by
A. G. Peifer.
The Duplexer as a Means of Eliminating
Interference from Nearby High-Power
Radar Systems by I. Reingold and J. L.
Carter.
A New Method of Modulating Electron
Beams for Pulse Applications and Linear
Amplitude Modulation Systems by G. M.
W. Badger.
Behavior of a Backward-Wave Oscil-
lator with External Feedback by F. L.
Vernon, Jr.

**GENERAL COMMUNICATIONS
SYSTEMS**
SSB Modulation for Scatter Propaga-
tion by F. H. Gerks and R. P. Decker.
FM Scatter System Measurements by
R. W. Britton and H. D. Hern.
Theory of Feedback Around the Limiter
by E. J. Baghdady.
General Systems Approaches to Tele-
communication Optimization Problems by
R. E. Kalaba and M. L. Juncosa.
The Future Airforce Communication
System by C. K. Chappuis.

MEDICAL ELECTRONICS
A Magnetic Tape Recording System for
Teaching Electrocardiography by G. N.
Webb and W. R. Milnor.
Ultrasonic Dosimetry for Medical Use
by V. T. Tomberg.
An Electrical Circuit Analogy for
Isotope Kinetics by R. L. Schoenfeld and
M. Berman.
Electronic Control of the Artificial
Respiration Cycle by L. H. Montgomery.
The Incorporation of Picture Storage
With the Technique of X-ray Fluoroscopy
by W. Gombash, Jr.

**NEW OPERATIONAL
TECHNIQUES CONCERNING
VIDEO TEST SIGNALS—
A PANEL DISCUSSION**
J. R. Popkin-Curman, F. Davidoff,
J. W. Wentworth, R. M. Morris, W. B.
Whalley, H. C. Gronberg, V. Hatch, and
E. W. Chapin.

**HIGH FIDELITY AND HOME
MEASUREMENTS**
Intermodulation Distortion: Its Meas-
urement and Evaluation by A. Peterson.
Testing High-Fidelity Amplifiers in the
Home by W. W. Dean.
Disk and Manetic Tape Phonograph Sys-
tems by W. H. Erickson.
Improved Low-Frequency Loudspeaker
Performance by S. Zuerker.
A Low-Pressure Phonograph Cartridge
by W. E. Glenn.
A High-Fidelity Phonograph Repro-
ducer by B. B. Bauer, and L. Gunter.

**ANTENNAS II—BROADBAND
ANTENNAS**
High-Frequency Steerable Beam An-
tenna System by E. Hudock.
Constant Beamwidth Broadband Anten-

YOU CAN ALWAYS

RELY ON
WHITSO

FOR
INSULATED
TERMINALS
AND OTHER
ELECTRONIC
COMPONENTS

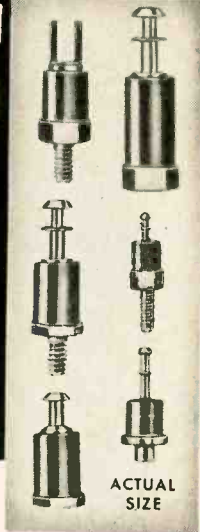

HERE'S
WHY:

We are specially equipped to
furnish standoff and feed through
terminals in a full range
of materials and sizes . . . in
economical quantity runs . . . from
either our standard line or custom
fabricated to your specifications . . .
and deliver them promptly.

Whitso Standoff Terminals
are available in over 100 varieties . . .
fork, single and double turret, post
and miniature types . . . male,
female or rivet mountings . . . molded
or metal base. They are molded
from melamine thermosetting materi-
als for best electrical properties.

Whitso Feed Through Terminals
can be furnished as standard
or to your individual
specifications.



Whitso Melamine Jacks
are electrically and mechanically
designed for long, reliable service.
A wide range of colors are
available for color coding.
Special colors can be supplied.

Whitso Pointer Knobs,
widely popular in military
use, are readily suited to
countless communications
and industrial applications.
They are supplied in
attractive black phenolic
with satin finish.



Whitso Custom Molded Parts
for electro-mechanical use include
general purpose, mica filled and high
impact phenolics, ureas, melamines,
alkyds, glass reinforced alkyds
and nylons.

Get full facts on
Whitso terminals and
other electronic
components. Ask
for our new
catalog.



WHITSO, INC.

9328 Byron Street, Schiller Park, Illinois
(Chicago Suburbs)

Want more information? Use post card on last page.
March 1, 1957 — ELECTRONICS

nas by C. F. Parker and R. J. Anderson.
 Broadband Traveling-Wave Antennas
 by D. K. Reynolds.
 Evaluating the Impedance Broadbanding
 Potential of Antennas by A. Vasiliadis
 and R. L. Tanner.
 A. Frequency Independent Antennas by
 V. H. Rumsey.
 B. Broadband Logarithmically Periodic
 Antenna Structures by R. H. DuHamel
 and D. E. Isbell.

**INFORMATION THEORY:
 APPLICATIONS**

An Inductive Inference Machine by
 R. J. Solomonoff.
 Multicase Binary Codes for Nonuniform
 Character Distributions by F. P. Brooks,
 Jr.
 Binary Transmission Through Noise
 and Fading by Masonson.
 An Estimate of the Degradation in
 Signal Detection Resulting from the
 Addition of the Video Voltages from Two
 Radar Receivers by H. L. McCord.
 The X Carrier: A Telephone Carrier
 System Employing Bandwidth Compression
 by J. W. Halina.

**TELEVISUAL SYSTEMS
 DEVICES**

The Development of 110° Television Picture
 Tubes Having on Ion Trap Electron
 Gun by L. E. Swedlund and L. C. Wimpee.
 Image Tube Utilizing Bombardment
 Induced Conductivity by R. W. Decker
 and R. J. Schneeberger.
 New Development in the Panel Light
 Amplifier by B. Kazan.
 An Electrostatic Character-Writing
 Tube by K. Schlesinger, B. Maggos, and
 A. F. Hogg. A High Speed, Low Voltage
 Light Modulator by A. C. Koelsch.

**Tuesday Evening
 APPLICATION OF THE
 ELECTRONICS ART TO THE
 CIVIL-MILITARY NATIONAL
 COMMON SYSTEM OF AIR
 TRAFFIC CONTROL**

Moderator: J. L. Anast
 S. Alexander, C. Wheeler, L. Perper, V.
 Weihe, and S. Barkowitz.
 A discussion of plans, research, and de-
 velopment on national aviation air traffic
 control facilities and systems and the
 use of electronics in the program.

**MICROMINIATURIZATION—
 THE ULTIMATE TECHNIQUE**

Philosophy of Microminiaturization
 Technique by C. Brunetti.
 The Challenge of the Environment by
 E. F. Carter.
 Material Constituents and Components
 by H. A. Stone, Jr.
 Today's Applications and Equipments
 —Military, Brig. Gen. E. R. Petzing
 (ret.).
 —Missiles, J. R. Moore.

**Wednesday Morning
 March 20**

**ELECTRONIC COMPUTERS
 I—DIGITAL COMPUTERS**

An RCA High-Performance Tape Transport
 System by S. Baybick and R. E.
 Montijo. A Magnetic Ulse-Current Regu-
 lator by J. D. Lawrence, Jr. and T. H.
 Bonn.
 Diodeless Magnetic Core Logical Circuits
 by L. A. Russell.
 Digital Computer Designs Circuit for
 Longest Mean Time to Failure by Alman,
 P. L. Phipps, and D. L. Wilson.
 The Design of a Logic for the Recognition
 of Printed Characters by Simulation
 on the IBM 650 MIDDPM by E. C.
 Greanias, C. J. Hoppel, M. Kloomok, and
 J. S. Osborne.

MAGNETIC RECORDING

An Approach to Quantitative Methods
 for Evaluation of Magnetic Recording
 System Performance by C. B. Stanley.
 The Application of WOW and Flutter
 Compensation Techniques to FM Mag-
 netic Recording Systems by R. L. Peshel.
 Design of Instrumentation Magnetic
 Tape Transport Mechanisms, by K.
 Schoebel.
 The Reverbetron by P. C. Goldmark
 and J. M. Hollywood.
 A Multichannel Transducer for Mag-
 netic Recording by H. A. Johnson.

NUCLEAR INSTRUMENTATION

Track Recognition System for Scan-

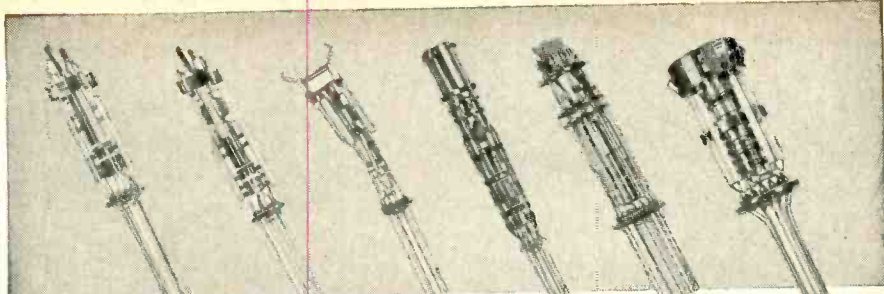

Superior manufactures superior
ELECTRONIC GUN MOUNTS!

For the CRT industry, SUPERIOR offers a full range of magnetic, electrostatic and color gun mounts including mounts for the 110° narrow neck tubes . . . all precision engineered. SUPERIOR makes a complete line of electrostatic focus and deflection guns for radar and industrial purposes including character and Vidicon-type mounts. You may order standard types or we will design and build to your specifications. Whether your order be large or small, you will enjoy all the benefits of our rigid inspection, testing and control. For complete satisfaction based on dependable service, call or write to

SUPERIOR  ELECTRONICS

CORPORATION

208-212 Piaget Ave. • GRegory 2-2500 • Clifton, N. J.

for service and lab. work

Heathkit
 PRINTED CIRCUIT
OSCILLOSCOPE KIT
 FOR COLOR TV

① Check the outstanding engineering design of this modern printed circuit Scope. Designed for color TV work, ideal for critical Laboratory applications. Frequency response essentially flat from 5 cycles to 5 Mc down only 1 1/2 db at 3.58 Mc (TV color burst sync frequency). Down only 5 db at 5 Mc. New sweep generator 20-500,000 cycles, 5 times the range usually offered. Will sync wave form display up to 5 Mc and better. Printed circuit boards stabilize performance specifications and cut assembly time in half. Formerly available only in costly Lab type Scope. Features horizontal trace expansion for observation of pulse detail — retrace blanking amplifier — voltage regulated power supply — 3 step frequency compensated vertical input — low capacity nylon bushings on panel terminals — plus a host of other fine features. Combines peak performance and fine engineering features with low kit cost!



MODEL
 O-10
\$695.00
 Shpg. Wt.
 27 lbs.

Heathkit TV
SWEEP GENERATOR KIT
 ELECTRONIC SWEEP SYSTEM

② A new Heathkit sweep generator covering all frequencies encountered in TV service work (color or monochrome). FM frequencies too! 4 Mc — 220 Mc on fundamentals, harmonics up to 880 Mc. Smoothly controllable all-electronic sweep system. Nothing mechanical to vibrate or wear out. Crystal controlled 4.5 Mc fixed marker and separate variable marker 19-60 Mc on fundamentals and 57-180 Mc on calibrated harmonics. Plug-in crystal included. Blanking and phasing controls — automatic constant amplitude output circuit — efficient attenuation — maximum RF output well over .1 volt — vastly improved linearity. Easily your best buy in sweep generators.



MODEL
 TS-4
\$495.00
 Shpg. Wt.
 16 lbs.

Heath
 COMPANY
 A SUBSIDIARY OF DAYSTROM, INC.
BENTON HARBOR 14, MICH.

WRITE FOR FREE CATALOG
 . . . COMPLETE INFORMATION

D.C. POWER SUPPLIES

For IMMEDIATE DELIVERY



OUTPUT
0-30 V.D.C.
5 Amps.

RIPPLE: 1/2 % of Maximum Load
REGULATION: 1/10 Load, 34.5 V.
Full Load, 30.0 V.

RACK MODEL (illus.) KM75
BENCH MODEL KM75B

Request Bulletin No. 93



OUTPUT
0-30 V.D.C.
10 Amps.

RIPPLE: 1% of Maximum Load.
REGULATION: 1/10 Load, 35 V.
Full Load, 30 V.

RACK MODEL (illus.) KM81
BENCH MODEL KM81B

Request Bulletin No. 96



OUTPUT
0-28 V.D.C.
20 Amps.

RIPPLE: 1% at Maximum Load.
REGULATION: 1/10 Load, 33 V.
Full Load, 28 V.

RACK MODEL (illus.) KM88
BENCH MODEL KM88B

Request Bulletin No. 100



DUAL OUTPUT
0-32 V.D.C.
40 Amps.
0-64 V.D.C.
20 Amps.

RIPPLE: Less than 1%.
REGULATION: 1/10 Load, 36.5/73V.
Full Load, 32.0/64V.

RACK MODEL KM95
BENCH MODEL (illus.) KM95B

Request Bulletin No. 103

UNFILTERED MODELS AVAILABLE
Request Bulletin No. 178



New O-PAC
Self-Contained DC Power Pack

OUTPUT
30 V.D.C. ± 6.5%
0-1 Amp.

MODEL
3150
\$45.00

RIPPLE: Less than 1%.
INPUT: 115 V.A.C. 60 cy.
DIMENSIONS: 4 3/4 x 6 x 6 3/8"

Request Bulletin No. 185

Opad

ELECTRIC COMPANY

69-2 MURRAY STREET • NEW YORK 7, N. Y.
Telephone: BEekman 3-7548

PLANTS AND PEOPLE

(continued)

ning Nuclear Emulsions by S. Becker and J. Franceschini.

Multichannel Analyzer for Time-of-Flight Experiments by H. L. Garner, R. E. Miller, S. H. McMillan, and R. R. Graham.

0.1-Microsecond, 2000-Channel, Electrostatic Storage System for Time-of-Flight Experiments by J. Hahn.

New Double-Line Linear Amplifier by G. G. Kelly.

Radioisotope Thermoelectric Generator by J. L. Briggs.

CIRCUIT THEORY I— SYMPOSIUM ON MODERN METHODS IN NETWORK THEORY

Synthesis Techniques and Active Networks by J. C. Linvill.

The Frequency-Time Representation of Signals Using Natural Components by W. H. Huggins.

Signal Flow Graphs and How to Avoid Them by S. J. Mason.

Panel Discussion on Current Problems in Network Theory

Moderator: S. Darlington.
J. G. Linvill, W. H. Huggins, and S. J. Mason.

ENGINEERING MANAGEMENT TECHNIQUES

The Art of Selection of Engineering Management by C. W. Randle.

The Art of Human Relations: Manipulation or Motivation by A. Levenstein.

The Art of Delegation of Authority by W. J. E. Crissie.

TRANSISTOR APPLICATIONS

Circuit Considerations for High-Frequency Amplifiers Using Drift Transistors by J. W. Englund and A. L. Kestenbaum.

Design Considerations in the First Stage of Transistor Receivers by L. A. Freedman.

A Six-Transistor Portable Receiver Employing a Complementary Symmetry Audio Output Stage by D. D. Holmes.

Transistor Receiver Circuits by A. Proudfit, K. M. St. John, C. R. Wilhelmson, and R. J. Farber.

Transistor Circuit Problems in TV Receiver Design by E. M. Creamer, Jr., L. H. DeZube, and J. B. McCallister.

MICROWAVE ANTENNAS

A Versatile Multiport Biconical Antenna by R. C. Honey and E. M. T. Jones.

Recent Annular Slot Array Experiments by K. C. Kelly.

Radiation from Modulated Surface-Wave Structures—I by F. J. Zucker and A. S. Thomas.

Radiation from Modulated Surface-Wave Structures—II by R. L. Pease.

The "Sandwich Wire" Antenna: A New Microwave Line Source Radiator by W. Rotman and N. V. Karas.

Recent Developments in the Study of Printed Antennas by J. A. McDonough and R. G. Malech.

ELECTRON TUBES—GENERAL

Practical Design Theory for Minimization of Vibration Noise in Grid-Controlled Vacuum Tubes by G. Gross.

Electrolytic Tank Measurements of Mesh Grid Characteristics by H. Hsu and C. E. Horton.

Rare-Earth Oxide Cathodes by L. J. Cronin and J. H. Apfelbaum.

Temperature Distribution in Anode Structure for Pulse Input by R. N. Ghose.

A Positive Grid Voltage-Space Current Division Test for Power Vacuum Tubes by J. A. Jolly.

Electron Tubes for Critical Environments by W. H. Kohl.

Wednesday Afternoon SYMPOSIUM: LONG RANGE TELEMETRY AND REMOTE CONTROL

Electronic Control and Instrumentation of Extra-Atmosphere Space Craft by M. V. Kiebert, Jr.

Progress in Telemetering of Data from High-Velocity Missiles in Upper Atmosphere by R. J. Burke.

Long-Range Telemetering Reception by J. B. Wynn.

Some Dynamic Aspects of Control at

1500 VOLT

single junction



welded case



SILICON



RECTIFIERS



from

Texas Instruments

You can now obtain maximum rectifier miniaturization along with nearly double the operating voltage previously obtainable from silicon rectifiers — with new TI *single element* grown junction silicon rectifiers.

This two-fold advance — single element construction plus 1500-volt operating voltage — results in immediate extension of design limits in guided missile and other military applications. Also, these welded case rectifiers are ideal for use in series in cathode ray tube power supplies and similar high voltage circuits.

TI miniaturized silicon rectifiers feature forward current ratings to 125 ma and operate stably to 150°C. They require no filament power... no warm-up time. Five production types give you a choice of axial and stud half-wave types in welded case and full-wave plug-in model.

Write today for complete information



TEXAS INSTRUMENTS
INCORPORATED
6000 LEMMON AVENUE DALLAS 9, TEXAS

Want more information? Use post card on last page.

March 1, 1957 — ELECTRONICS

Want more information? Use post card on last page.

MICO

NEW HEAVY-DUTY 2 & 3 DIMENSIONAL ENGRAVER

FOR Engraving Nameplates Fine Routing Work Profiling Small Objects Making Small Dies and Molds



FEATURES OF NEW ENGRAVER

1. Six Reduction Ratios—From 1.5:1 to 4:1.
2. Heavier bearings in micrometer spindle.
3. New 1/10 H.P. Ball Bearing Motor permits continuous operation for die or mold work in steel.
4. Absolute accuracy in three-dimensional reproduction.
5. Uses standard taper-shank cutters or 1/8" diameter straight shank cutters and end mills.
6. Copy and work right-side-up; always in direct view of operator.
7. Many attachments available to increase versatility of machine.

Catalog on request

MICO INSTRUMENT CO.

76-E Trowbridge St.

Cambridge 38, Mass.

now...

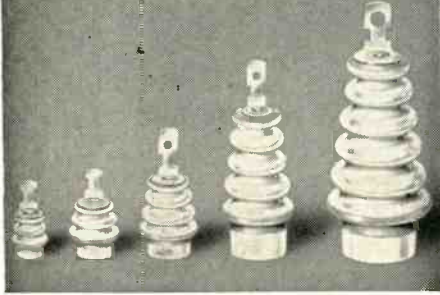

Frenchtown Metallized Terminals!

Here is Frenchtown's improved line of Annulated Type NICOTE Metallized Hermetic Terminals for use in controls, relays, transformers, capacitors, motors, and heater units. Custom-engineered of HIGH ALUMINA CERAMICS and metallized with our exclusive NICOTE, these terminals are available in six varying sizes with a choice of terminal hardware to fit any exacting application. Write for Engineering Bulletin 1055.

frenchtown PORCELAIN COMPANY

86 Muirhead Avenue • Trenton 9, N. J.

National Representatives: Lunday Associates
694 Main St., Waltham 54, Massachusetts

To Solve
Your Problems in
Conductive Silver Coatings
try

DRAKENFELD

SILVER PAINT
AND SILVER PASTE
TAILORED TO MEET YOUR NEEDS



Special Compositions for Glass and Ceramic Bodies and other Materials



Ask for a Sample Made to Fit Your
Specific Requirements Write to:

B. F. DRAKENFELD & COMPANY, INC.

Box 519, Washington, Pennsylvania

Drakenfeld

YOUR PARTNER IN SOLVING CONDUCTIVE COATING PROBLEMS

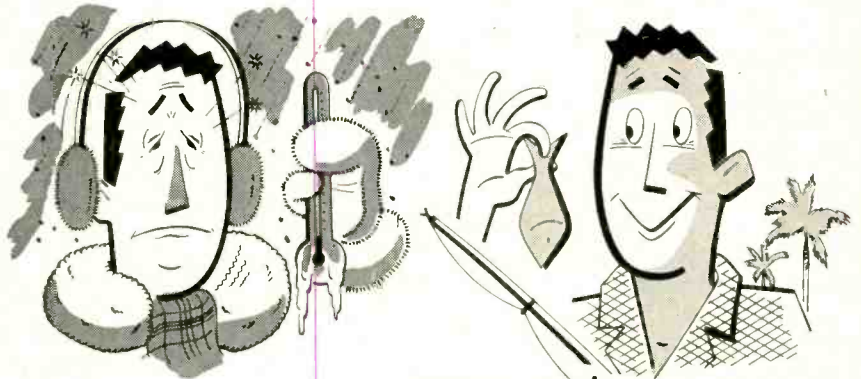

Here in Greater Miami
Personnel Managers have few headaches

Personnel problems practically vanish here, for hard-to-find employees, like engineers... skilled technicians... become readily available when you advertise openings in a plant in Greater Miami—America's No. 1 area for personnel recruitment. You can select the best men from among many applicants for every part of your plant...resulting in top quality, low-cost production.

The 1700 manufacturers here know that this fact means greater profits—that's why "There's a Hard Dollar Reason for locating your plant in Greater Miami." —Send, on your letterhead, for 30-page Fact File—**complete statistical area analysis.**



GREATER MIAMI INDUSTRIAL DIVISION

DADE COUNTY ADVERTISING DEPT. 199 • 141 N. E. 3rd AVE. • MIAMI, FLORIDA • PHONE FR 1-3611

Long Ranges by D. T. Sigley.
 Problem in Measuring the Space Environment on the Earth by A. J. Max.
 A Microwave Telemetry Relay by K. A. Hall, B. J. Lamberty, and L. S. Tavior.

SPEECH ANALYSIS AND AUDIO AMPLIFIERS

A Demonstration of the Representation of Speech by Poles and Zeros, by S. H. Chang and R. Bach, Jr.
 A High-Efficiency Speech Amplifier by H. Sullivan and J. Nelson.
 Fifty-Watt High-Quality Transistor Audio Power Amplifier by A. Bereskin.
 Low Noise Transistor Microphone Amplifier by J. J. Davidson.
 Circuit Considerations for Audio Output Stages Using Power Transistors by R. E. Minton.

TRANSISTORIZING NUCLEAR INSTRUMENTATION

Transistorizing Nuclear Instruments—A Status Report, by R. Shea.
 Noise in Transistor Nucleonic Pulse Amplifiers by A. R. Jones.
 Recent Advances in Transistorizing Reactor Controls by K. H. Klein.
 Transistorized Time of Flight Analyzer with Ferrite Core Memory by E. J. Wade and D. S. Davidson.

SYMPOSIUM ON APPLICATIONS OF COMPUTERS IN BIOLOGY AND MEDICINE

R. Pepinsky, M. Edin, B. Chance, W. Mauchly, and R. S. Ledley.
COLOR TELEVISION

Developments in Color TV in Europe by C. J. Hirsch.
 Brightness Enhancement Techniques for the Single-Gun Chromatron by R. Dressler, P. Neuwirth, and J. Rosenberg.
 Accuracy of Color Reproduction in the "Apple" System by J. B. Chatten and R. K. Gardner.

Recent Improvements in the Apple Beam Indexing Color Picture Tube by H. R. Colgate, C. P. Comeau, D. P. Kelley, P. D. Payne, and S. W. Moulton.
 An Advanced Color Television Receiver Using a Beam Indexing Picture Tube by R. A. Bloomsburgh, A. Hopengarten, R. C. Moore, and H. H. Wilson.

MICROWAVES I—COMPONENTS

A Broadband Fixed Coaxial Power Divider by J. Reed and G. J. Wheeler.
 Broadband Waveguide-to-Coax Transitions by G. J. Wheeler.
 Transmission Properties of Hybrid Rings and Related Annuli by H. T. Budenbom.
 Development of Circularly Polarized Microwave Cavity Filters by C. E. Nelson and W. L. Whirry.
 Design of Improved Microwave Low-Pass Filters Using Strip-Line Techniques by R. A. Van Patten.
 Broadband Frequency Stabilization of a Reflex Klystron by Means of an External High "Q" Cavity by M. Magid.

PRODUCTION TECHNIQUES

The Use of Mechanized Wiring for Short Run and Long Run Production of Electronic Assemblies by F. Rosenthal.
 An Approach to Airborne Digital Computer Equipment Construction by P. E. Boron and E. N. King.
 An Automatic Dip Soldering Machine by V. O'Gorman.
 Encapsulation of Electronic Circuits by R. Calicchia.
 Development of Interconnecting Wiring by D. J. Keller.

Thursday Morning, March 21
ELECTRONIC COMPUTERS II
—SYMPOSIUM ON COMPUTERS IN SIMULATION, DATA REDUCTION, AND CONTROL
 E. L. Braun, W. F. Gunning, W. F. Bauer, A. K. Susskind, L. R. Turner, and J. H. Rawlings.

CIRCUIT THEORY II—TRANSISTOR AND AMPLIFIER CIRCUIT DESIGN

Some Useful Techniques for Overcoming Frequency Limitations of Distributed Amplifiers by P. H. Rogers, B. F. Barton, and L. A. Beattie.
 Regeneration Effects in Double-Tuned

NEWS FOR IMMEDIATE RELEASE!

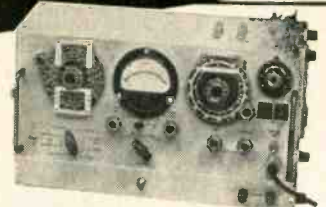

NEW ALPHA Q METER Model 162

noteworthy features:
 NO THERMOCOUPLE TO BURN OUT.
 NO SPECIAL TUBES. Almost impossible for overloads to damage meter. Wide frequency range — 50 kc/s to 75 mc/s. Internal regulation in both 110 and 220 volt operation. Easily operated by inexperienced personnel. Injection voltage (always 20 millivolts) easy to monitor; meter easy to read. Dust cover protects all controls.

For complete specifications write to

ALPHA INSTRUMENT CO.

Dept. E.
 43 Hempstead St., New London, Connecticut
 Reqs. Some territories still open

Soon to be released!
 FM Signal Generators • Circuit Analyzers

THESE RUGGED JOHNSON VARIABLES WITHSTAND TERRIFIC VIBRATION and SHOCK!

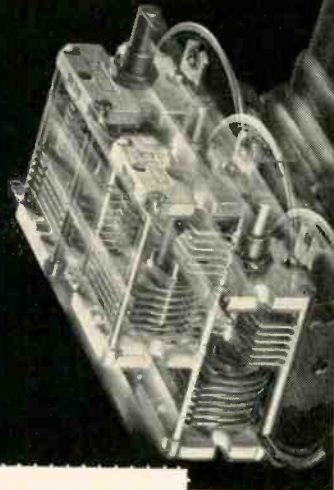

Ceramic-soldered for greater strength!



Parts can't break loose... capacity can't fluctuate!

These ceramic-soldered Johnson Type "L" capacitors are an ideal choice for applications requiring extreme stability and strength. Rotor bearings and stator support rods are actually soldered directly to the heavy 3/16" thick steatite ceramic end frames. Impervious to shock and vibration, parts can't break loose... capacity can't fluctuate.

SPECIFICATIONS

Plate spacing is .030" rated at 1500 volts peak at sea level; over 300 volts at 50,000 feet altitude. Plating is heavy nickel... other platings available on special order. Requires 1 3/8" x 1 3/8" panel mounting area.

• For complete information on Johnson Type "L" Air Variables or other quality Johnson components—write for your free copy of our newest catalog today!

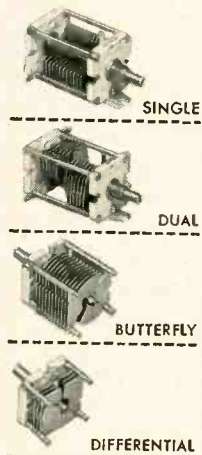

E. F. Johnson Company
 2009 SECOND AVE. S.W. • WASECA, MINN.

Want more information? Use post card on last page.

"INDUSTRIAL"

Automaton PRINTED CIRCUIT SOCKET



First socket designed expressly for AUTOMATION...

- EASY INSERTION** • Bullet nose terminals provide for easy location and insertion.
- MECHANICAL LOCK-IN** • Notches in terminals provide for locking of sockets into chassis. Will not loosen with vibration or handling.
- PERFECT SOLDER JOINT** • Round terminals contact copper foil on entire circumference of chassis hole.
- RIGID TERMINALS** • Will not deform in shipping or handling.
- Opening between socket and chassis provides for good heat dissipation. Available in 7 and 9 pins; also available with tube shield clip.



I R E SHOW • BOOTH 2715

Samples and information on request.

INDUSTRIAL HARDWARE

Manufacturing Company, Inc.

109 PRINCE ST., NEW YORK 12, N.Y.

Want more information? Use post card on last page.

EXTRA CURRENT FOR TESTING NEEDS
KATO VARIABLE
 MOTOR GENERATOR SETS
 FREQUENCY

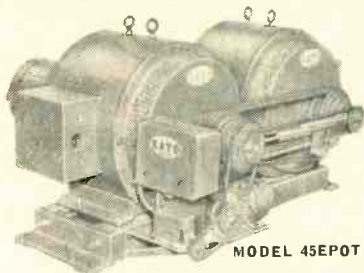

MODEL 45EPOT

AUTOMATIC ADJUSTMENT MODEL

Fully automatic variable frequency motor generator set adjusts 360 to 400 CPS. Generator mounted controls include reset buttons, Cutter Hammer Limit Switch. Motor and generator remain stationary. Vari-drive pulley adjustment controlled by small motor. Remote control panels available. Units can be equipped with synchronous motor starter and magnetic amplifier automatic voltage regulator.

MANUAL ADJUSTMENT MODEL

Easily adjusted by simple hand wheel controlling variable pitch pulley V-belt arrangement. This Motor Generator Set gives 45 to 60 CPS output. Unit holds speed accurately. Frequency meter indicates output. Single phase generator speed varies from 1350 to 1950 rpm.

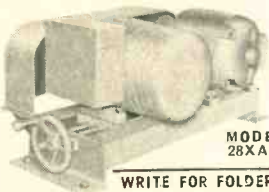

MODEL 28XA08

WRITE FOR FOLDER!

Builders of fine Electrical Machinery Since 1928

KATO Engineering Company
 105 MAXFIELD AVENUE, MANKATO, MINN.

SCATTER

SSB

DIGITAL

**Communications
 Systems**

Unusual opportunities for senior electronics engineers experienced in the development and design of advanced equipment for Scatter, SSB, and Digital Communications Systems. Specialized areas of particular interest are frequency synthesizers, modulators, automatic tuning devices, broad-band amplifiers, and transistor circuits. HF, VHF, UHF and SHF military applications.

Please address inquiries to:
 Mr. Frank C. Nagel

**The Ramo-Wooldridge
 Corporation**

5730 ARBOR VITAE STREET
 LOS ANGELES 45, CALIFORNIA

**Visit the Dynamic World
 of Plastics**



An industry-wide trade show featuring new materials... new methods... new equipment... and new applications from the plastics industry.
 Plan now to attend.
 Please request tickets on your company letterhead, since there are no general public admissions.

**Pacific Coast
 Plastics Exposition**
 March 18-21, 1957
 Shrine Exposition Hall
 Los Angeles, California

Sponsored by: The Society of the Plastics Industry, Inc.
 250 Park Avenue • New York 17, New York

**PRECISION
 PLASTIC
 CAPACITORS
 AT
 COMPETITIVE
 PRICES!**

POLYSTYRENE and MYLAR*
 Capacitance From .001 mfd to any value
 Voltage From 50 V.D.C. to 30 KV
 Tolerance Polystyrene From $\pm 0.1\%$ to $\pm 5\%$
 Mylar* From $\pm 1\%$ to $\pm 10\%$

SMALLEST CASE SIZES
TUBULAR—BATHTUB—RECTANGULAR
 Very Good Deliveries *DuPont T.M.

PRECISION CAPACITORS, INC.
 150 W. Cypress Ave. Burbank, Calif.

Teflon*

* dupont trademark

Precision Molded, Machined Parts, and Film Applications

Literature sent on request

O. J. Maigne Co.

323 Pearl St., New York 38, WOrth 2-1165

Incorporated in 1904

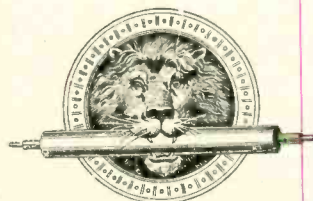

MICRO-MINIATURE Metallized Paper CAPACITORS

NEW!

Contain all of the outstanding Hopkins quality characteristics so well recognized throughout the world. Super-small for transistorized circuits and other compact circuitry requirements. Only $\frac{3}{8}$ " max. length in values from .005 to .05. Standard tolerances in voltage ratings from 100 to 400 VDC. Operating temperature range from -55°C to $+100^{\circ}\text{C}$, without voltage derating. Hermetically sealed in metal cans or phenolic encased. Prompt delivery.

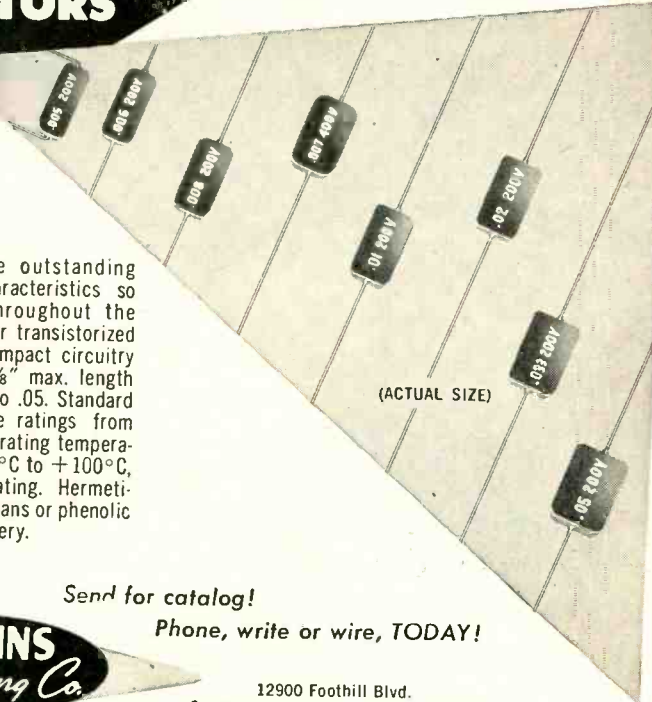

Send for catalog!

Phone, write or wire, TODAY!

HOPKINS
Engineering Co.

12900 Foothill Blvd.
San Fernando, Calif. • Empire 1-8693
Offices in Washington, D.C. and San Francisco

RIBBONS • STRIPS

★ PURE TUNGSTEN
★ MOLYBDENUM
★ THORIATED TUNGSTEN
★ SPECIAL ALLOYS

of
and OTHER METALS
IN
ULTRA THIN SIZES

to
TOLERANCES CLOSER THAN COMMERCIAL STANDARDS
by

OUR SPECIAL ROLLING TECHNIQUE

Note: for highly engineered applications—strips of TUNGSTEN and some other metals can be supplied

ROLLED DOWN TO .0003 THICKNESS

- Finish: Roll Finish—Black or Cleaned
- Ribbons may be supplied in Mg. weights if required

For HIGHLY ENGINEERED APPLICATIONS

DEVELOPED AND MANUFACTURED BY

H. CROSS CO.

15 BEEKMAN ST., N. Y. 38, N. Y.
TELEPHONE: WOrth 2-2044
COrtlandt 7-0470

Band-Pass Amplifiers by P. Bura.

A New Junction-Transistor High-Frequency Equivalent Circuit by R. D. Middlebrook.

Circuit Applications of Semiconductor Junction Capacitance by F. H. Dill, Jr., and L. Depian.

Pulse Circuit Applications of a New Semiconductor Device by R. A. Stasior.

Design of Junction Transistor Multipliers by Driving-Point Impedance Methods by J. J. Suran.

COMPONENTS PART I

Ceramic Filter Capacitors for VHF and UHF by H. M. Schlicke.

Manufacture and Measurement of Close Tolerance Temperature Compensating Ceramic Capacitors by N. Rudnick.

New Subminiature Metallized Paper Capacitors by P. P. Grad.

The Use of Pulse Packages in Line-Type Pulsers by A. Luna.

The Silver Oxide-Cadmium Alkaline Secondary Battery by P. L. Howard.

INDUSTRIAL ELECTRONICS

Coding Problems Related to the Electronic Mail Handling System by M. M. Levy and A. Barszczewski.

Stabilized Magnetic Amplifier Circuits by H. W. Patton.

New Techniques for the Control of Resistance Welding Machines by J. L. Solomon.

Tube and Circuit Considerations Affecting Recovery Time of Hot-Cathode Thyratrons by J. A. Olmstead and M. Roth.

RELIABILITY PROGRAMS

Air Force Ground Electronic Equipment Reliability Improvement Program by J. J. Naresky.

A Reliability Program by R. E. Kuehn.

A Reliability Program for R&D Projects by E. F. Dertinger.

The Role of Quality Engineering in Procuring and Producing Reliable Products by R. A. Hulnick.

SYMPOSIUM: DIGITAL TECHNIQUES FOR PROBLEMS IN TELEMETERING AND REMOTE CONTROL

High-Speed Digital Data Handling System by G. F. Anderson.

Magnetic Tape Playback and Digital Conversion of Telemetered Flight Data for Entry into Digital Computers by G. C. Dannels.

Design Considerations for Super Speed Perforated Tape Digital Recording by J. Bellinger, J. MacNeill, and C. F. West.

A High-Speed Binary-to-Binary-Decimal Translator by C. A. Campbell.

Simplicity for Reliable Low-Cost Operation in a Digital Data Processing System by J. W. Prast.

MILLIMICROSECOND INSTRUMENTATION — SPECIAL TOPICS

Millimicrosecond Photography with an Electronic Camera by R. C. Maninger and R. W. Buntbach.

Electronic Detection and Photography of Incipient Rupture of High Speed Rotors by A. Warnick, R. Condit, J. Patraiko, and H. Feithman.

A Millimicrosecond Pulse Generator Using Secondary Emission Tubes by J. A. Narud.

A Fractional Microsecond Light Source of High Intensity by R. L. Forgas.

The Electrograph by R. A. Broding, J. C. Westervelt, and J. D. Schroeder.

Low-Level Transistorized DC Amplifier With Improved Stability by A. Warnick and C. N. Savage.

MICROWAVES II—SWITCHES

Precision High-Speed Microwave Switch by W. E. Fromm, S. H. Klug, and K. S. Packard.

Fast Acting Microwave Switch by H. H. Weichardt.

High-Speed Ferrite Microwave Switches by G. S. Uebele.

An L-Band Ferrite Coaxial Line Modulator by B. Vafades and B. J. Duncan.

Ferrite Microwave Detector by D. Jaffe, J. C. Cacheris, and N. Karayianis.

Thursday Afternoon ELECTRONIC COMPUTERS III —MAINLY ANALOG

Computation with Pulse Analogs by N. Rubinfeld.

A Cyclic Digital-to-Analog Decoder by G. H. Meyers.

An Automatic Analog Computer Method for Solving Polynomials and Finding Root

YOU'LL
FIND IT
ALL HERE



► If you are looking for new ways and means to improve your product, and save money too, here's an idea source guaranteed to spark your imagination and give you a wealth of hints, tips, and suggestions.

This 20-page fact-filled STAR catalog contains complete descriptive and engineering data on the full line of STAR Ceramics. A big selection chart, complete with mechanical and electrical properties, makes the job of selecting the right STAR material for your product a cinch. Like a free copy? Write today for Catalog 57.

the **STAR**
porcelain company
42 Muirhead Avenue, Trenton 9, N. J.

**CABLE
CLIPS**

★
of all Nylon
for severe conditions

★
of Ethyl
Cellulose
for maximum
economy



WECKESSER

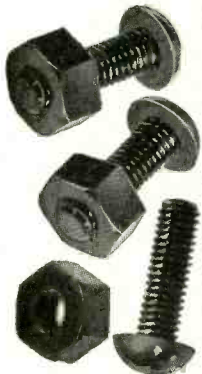

molded
**Black Nylon
SCREWS
and NUTS**

★ Acid resistant
★ Need no insulation
★ Can't rust
★ Can't corrode

WECKESSER COMPANY
5701 Northwest Highway • Chicago 30, Ill.

**COLOR TV
SHADOW MASKS**

—A development of BUCKBEE MEARS through close cooperation with TV industry engineers. Containing 400,000 close tolerance holes (.010" ± .0005"). Now produced in quantity on our especially designed continuous etching machines.



BUCKBEE MEARS COMPANY

TONI BUILDING
SAINT PAUL 1, MINN.

**ETCHED AND
ELECTRO-FORMED
PRECISION PARTS**

—Electric shaver combs, metal reticles for optical instruments, fine tube mesh and code discs.

These are but a few of the variety of parts that can be quickly produced to precise tolerances by our process. Send your specific problem and specifications to our engineers.

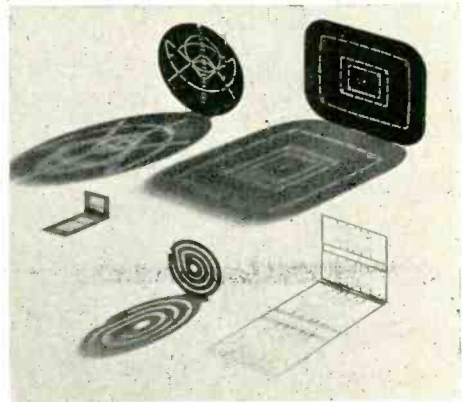

RESEARCH

**Electronic
Engineers**

**CAREER FULFILLMENT
IS A MAXSON TRADITION**

Too often ability and ambition go unrecognized simply because an engineer is associated with an organization whose scope is too shallow to permit complete expression. We sincerely believe that the currently expanding activities of The W. L. Maxson Corporation offer the creative engineer a limitless range of assignments for career fulfillment.

DEVELOPMENT

Responsible positions now available in the fields of research and development. Kindly send resume and salary requirements to:

Mr. L. W. Albright
Technical Placement Manager

THE W. L. MAXSON CORPORATION

460 W. 34th St.,
New York 1, N. Y.

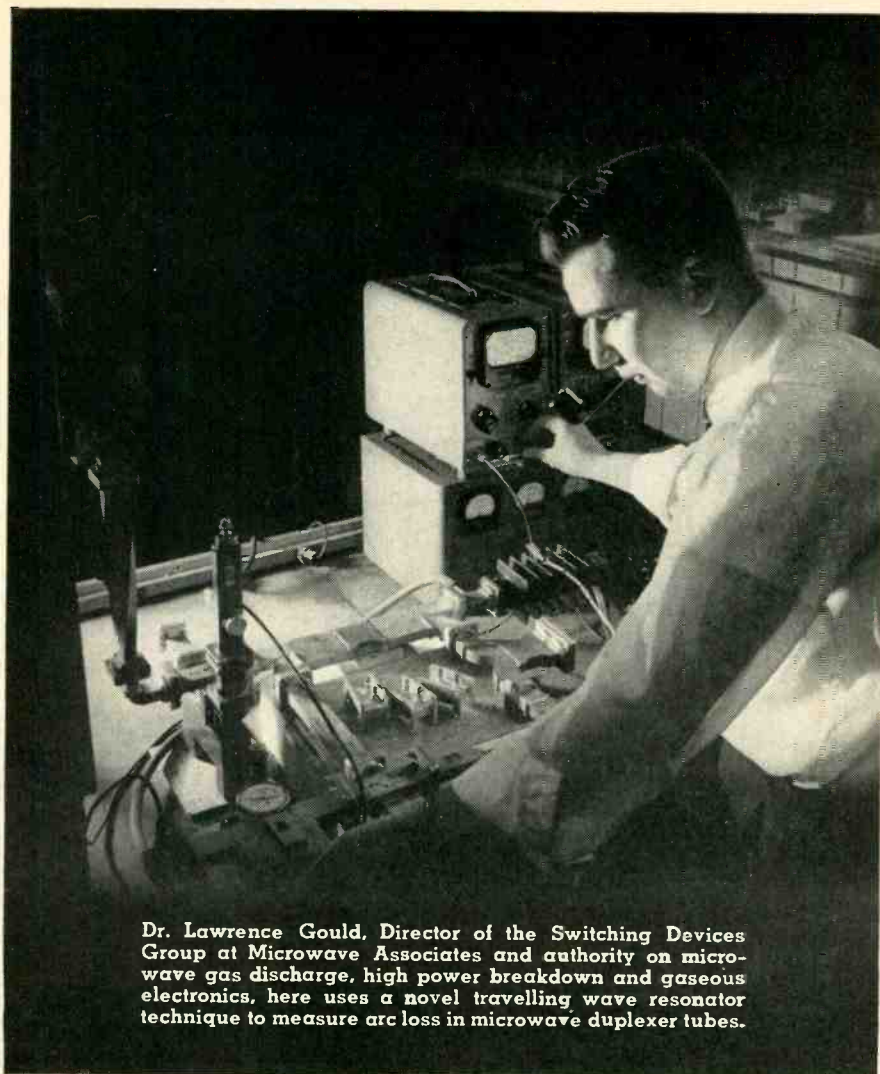

Dr. Lawrence Gould, Director of the Switching Devices Group at Microwave Associates and authority on microwave gas discharge, high power breakdown and gaseous electronics, here uses a novel travelling wave resonator technique to measure arc loss in microwave duplexer tubes.

... fast switch for tomorrow's power

New duplexer gas discharge program at Microwave Associates focuses basic research and development effort on switching tubes . . . today's weakest link in tomorrow's high power systems.

The rapidly expanding Microwave Associates Switching Devices group, under the supervision of Dr. Lawrence Gould, is engaged in a comprehensive program to determine the high power characteristics of gas discharges and their interaction with related microwave circuits.

This project, aimed at developing more effective TR switching tubes and duplexers having minimum arc loss, minimum recovery time and maximum bandwidth, is part of Microwave Associates' continuing program of product improvement.

Special measurement techniques have been developed by Dr. Gould and his associates to insure better control of tube operating characteristics,

longer life and increased reliability in microwave duplexer systems.

This program is expected to determine the practical ultimate limitations of a gas discharge for high power switching. Progress of the program has already been directly reflected in higher power ratings and improved design for Microwave TR tubes.

CAN YOU USE THIS HELP?

Are you facing problems in higher powers and better TR tube performance? A phone call to Dr. Gould will bring you immediate benefits from the results of this continuing program. Microwave Associates urgently invites you to work in close liaison with our research group.

MICROWAVE ASSOCIATES INC.



BURLINGTON, MASSACHUSETTS • BU 7-2711

See us at I.R.E. Show Booths 3237-3239

Loci by L. Levine and H. F. Messinger.
Magnetically Controlled Counters by E. A. Sands.
Systematic Tracing of Discrepancies in Analog Computers by M. Plotkin and E. Grosswald.

CIRCUIT THEORY III— NETWORK DESIGN TECHNIQUES

Pulse-Forming Networks Approximating Equal-Ripple Flat-Top Step Response by A. D. Perry.

Interstage Network Design with Practical Constraints by B. F. Barton.

Synthesis of Lumped Parameter Precision Delay Lines by E. S. Kuh.

On the Approximation Problem in Filter Designs by A. Papoulis.

Recent Advances in the Synthesis of Comb Filters by W. D. White and A. E. Ruvin.

Explicit Formulas for Tschebyscheff and Butterworth Ladder Networks by L. Weinberg.

COMPONENT PARTS II

Thermistors for the Gradual Application of Heater Voltage in Thermionic Tubes by J. J. Gano and G. F. Sandy.

New Levels of Performance for General Purpose Resistors in Army Applications by R. A. Osche.

Measurements and Effects of Error Rate in Precision Potentiometers by S. B. Rasmussen.

Theory, Measurement and Reduction of Precision Potentiometer Linearity Errors by F. Fritchle.

Vibration and Shock Resistant Delay Designs by A. P. Boylan and J. L. Pfeffer.

ANALYSIS AND TECHNIQUES FOR IMPROVED RELIABILITY

Guided Missile Reliability vs Complexity by S. W. Lichtman.

Narrow Limit Gage Sampling Procedure by H. G. Harding and S. Price.

Increased Reliability Through DC Overpotential Testing of Electronic Components by V. Wouk.

Reliability Calculations for Complex Systems by H. E. Blanton.

Analysis and Engineering Study of the Environmental Vibrations and Shock Characteristics of New Military Airborne Gimbaled Equipment by D. Ehrenpreis.

SYMPOSIUM: LOW LEVEL MULTIPLEXING FOR TELEMETERING AND REMOTE CONTROL

A Low-Level Electronics Switch by E. Dorsett.

Low-Level Signal Multiplexing by D. W. Hill and A. S. Westneat, Jr.

Reliable Operation of Commutation Switches of the Stationary Disk and Rotating Brush Assembly Variety at Relatively High Sampling Speeds by W. L. Switzer.

A Unique Wideband Transistorized Pulse Amplifier by W. T. Eddins.

Completely Transistorized Strain Gage Oscillator by W. H. Foster.

INSTRUMENTATION II

A Microwave Spectrometer for Industrial Use by J. F. Marion and G. J. Neumann.

A Unique Standard-Frequency Multiplier by J. K. Clapp and F. D. Lewis.

Measurement of the Complex Permeability of Magnetic Materials Over the Frequency Range of 50 to 500 Megacycles by I. Brady and R. J. Franklin.

An Automatic Impedance Plotter Based On a Hybrid-Like Net Work with a Very Wide Frequency Range by C. B. Watts, Jr. and A. Alford.

Automatic Indication of Receiver Noise Figure by A. J. Hendler and F. G. Haneman.

High Precision Sawtooth Generator by L. J. Torn.

MICROWAVES III—GENERAL

The Optimum Spacing of Bead Supports in Coaxial Line at Microwave Frequencies by D. Dettlinger.

Multiple-Line Directional Couplers by J. P. Shelton, Jr.

Effects and Measurement of Harmonics in High-Power Waveguide Systems by M. P. Forrer and K. Tomiyasu.

Microwave Dielectric Properties of Solids for Applications at Temperatures to 3000° F by D. M. Bowie.

Traveling-Wave Cavity for Ferrite Tensor Permeability Measurements by L. A. Ault, E. G. Spencer, and R. C. LeCraw.

The Principle of a Nongyromagnetic Ferrite Phase-Shifter by S. Wenglin.

New Books

Man of High Fidelity: Edwin Howard Armstrong

BY LAWRENCE LESSING
J. B. Lippincott Co., Philadelphia, Pa.,
1956, 320 p, \$5.00.

BIOGRAPHER Lessing has described Major Armstrong in terms of his environment, a condition necessary if the unacquainted reader is to understand even a fraction of Armstrong's genius and his mission. In thus contrasting his actions with those of the majority, the author may have made him seem less than human. There are few clear allusions to Armstrong's genuine courtesy, his consideration and his warm but unpublicized charity. His humility as a craftsman, doing what he could not quite trust others to do, is not entirely apparent.

The picture Lessing paints of a commercial atmosphere automatically inimical to the individual engineer and inventor may or may not be true for others as it was for Armstrong. It could be chilling and provocative reading for engineers of lesser strength and attainments than those of the Major. And it points up the real problem of financing modern research without destroying individual initiative.

► **History**—The biographer has been something less than tactful in dealing with historical facts. Assuming that today's young engineer is willing to accept Armstrong's contributions without considering their source, he is still baffled by situations in which Armstrong tried unsuccessfully to show the path out of the swamp. Current communications problems based on propagational facts are examples.

► **Prophecy**—Simply summed up, trouble from ionospheric interference is, indeed, now plaguing users of the 50-mc band vacated by the f-m broadcasters under a 1945 FCC order. Armstrong had taught that the superior interference protection of wide-band f-m would obviate such trouble—that trouble could occur for services with lesser protection.

Engineers can, however, be most grateful to Lessing for unraveling

and displaying for laymen the incredibly tangled skein of patent legalities that finally impoverished a multimillionaire inventor and cost the world his life.—A. A. McK.

Communication Engineering

BY W. L. EVERITT and G. E. ANNER.
McGraw-Hill Pub. Co., Inc., 1956.
642 p, \$9.00.

THE new edition of "Communication Engineering" treats a limited number of areas basic in the field of communications, chiefly covering networks and transmission lines. These subjects are preceded by an excellent discussion of fundamental communications principles and followed by a useful chapter on electromechanical devices.

Widespread use of the second edition makes it worthwhile to compare the new greatly revised third edition with that earlier one. The present edition has eliminated not only a number of sections covering material topical in 1936, but has also eliminated sections that represented specific design details: circuits of class A audio and radio amplifiers, detectors, modulators, antennas, propagation, etc. The book's orientation has thus been changed from one which somewhat emphasized handbook design to one of emphasis on principles which are likely to be as applicable in the future as they are today.

► **Well Correlated**—In comparison with other recent texts in the field of communication electronics, the limited scope of Everitt and Anner's book is offset by an unusual degree of coherence. For example, illustrations showing various aspects of a subject are well correlated, so that the reader can refer from one illustration to another and see readily the effects of changing some parameters while leaving others constant. Interrelationships between various chapters are also skillfully handled.

Understanding of the book does not require advanced mathematics;



MICROWAVE ASSOCIATES, INC.

*... a growing company
geared for big things*

The original organizers of Microwave Associates fostered the concept of sound, profitable growth in the field of microwave tubes, semiconductors, and waveguide components.

Our growth curve has been greatly accelerated by our association with American Broadcasting — Paramount Theatres, Inc. and the Western Union Telegraph Co. Backed by these companies and with an engineering management, we provide an unusual combination . . . the flexibility and resourcefulness of a small company coupled with the stability and strength of large industry.

Our product lines include some 88 silicon diodes, 20 TR tubes, 32 magnetrons and over 160 waveguide components.

We are maintaining a continuous and growing development and research program in all these fields plus special programs in magnetrons, gas switching tubes and ferrite devices.

All our engineering activities are now housed in a new 50,000 sq. ft. plant in Burlington, Mass. If you are working in the microwave field we cordially invite you to visit us and explore the possibilities our various programs may have for you. Get in touch with Mr. Robert Fitz who will gladly make the arrangements.

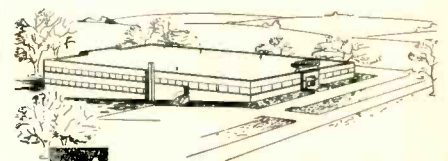

**MICROWAVE
ASSOCIATES INC.**

Burlington, Mass., BURLINGTON 7-2711

Want more information? Use post card on last page.

POWER TRANSFORMERS WITH "BUILT IN" SELF REGULATION

MADE IN SPECIAL RATINGS FOR YOUR EQUIPMENT

- Use one transformer — eliminate need for either a separate regulator transformer or tubes.
- $\pm 1\%$ variation in output voltage for line variation of $\pm 15\%$.
- Economy and reliability of conventional transformer constructions.
- Large or small quantities available.

WRITE FOR ENGINEERING BULLETIN AVR-1

CENTRAL TRANSFORMER COMPANY
900 W. JACKSON BLVD., CHICAGO 7, ILL.

**Eliminate
Rhodium
Plate
Rejects!**



only

RHODEX

produces compressively stressed deposits

assuring crack-free, peel-free service. Here's proof! The photograph demonstrates the high tensile stress of conventional rhodium electroplate and the CS of RHODEX. Dissolving the basic metal caused the conventional rhodium electroplate to disintegrate into small crystalline flakes. The Sel-Rex RHODEX electroplate remained unimpaired, and in a continuous film. RHODEX does not peel or crack regardless of thickness! Write for details.

Precious Metals Division



SEL-REX CORPORATION

155 Manchester Place Dept. E-3 Newark, N. J.

an effort has been made to familiarize the reader with hyperbolic functions and with Fourier transforms.

There are a few subjects whose inclusion (under chapter headings already in the book) might have better fulfilled the author's intent to concentrate on fundamental areas. These include more thorough discussion of multichannel systems and of pulse systems under modulation theory, greater emphasis on circuit duality in the sections on networks, and a fuller coverage of feedback's close relationship to amplifiers. However, these subjects and others deliberately omitted by the authors are treated in a variety of other texts.

Various minor errors, such as the incorrectly-drawn exact and approximate resonance curves in Figure 4-11, should not lead the reader astray; they will undoubtedly be corrected in the next printing.

In conclusion, the clarity and coherence within individual chapters and throughout the book should be of distinct advantage in understanding the background of a rapidly changing subject. This version represents enough of a change to be worthy of purchase even by those owning the second edition. ALFRED J. POTE, *Hycon Eastern, Inc., Cambridge, Mass.*

Electronics

BY A. W. KEEN. *Philosophical Library, New York*, 1956, 256 p, \$7.50.

THOUGH written for a nontechnical audience, this book covers a remarkable amount of advanced electronics and applications.

Starting with an answer to the question "What is Electronics?", the author Keen leads his readers through a simplified, yet concentrated, introduction to electron physics. The next few chapters introduce the basic components and control devices.

► **Circuits** — Before getting into equipment applications, the author gives a lucid explanation of the various basic circuit functions in amplification, rectification, wave shaping, switching, oscillation and

HARDWARE FOR ELECTRONICS INSTRUMENTS • AUTOMATION

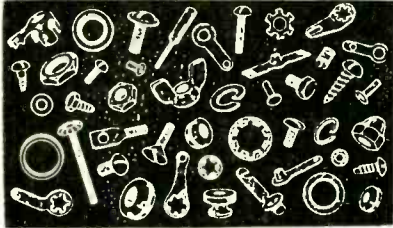

ONE Source
of supply
for
FASTENINGS

SCREWS
NUTS
BOLTS
WASHERS
RIVETS
EYELETS
TERMINALS
GROMMETS
ACCESSORIES

We carry in stock thousands of STANDARD and SPECIAL items essential to the INSTRUMENT, ELECTRONIC and AUTOMATION Mfg. industry.

Special Cold Headed Products

Stampings

Screw Machine Parts

Made to order in all metals.

WRITE FOR CATALOG

FEDERAL Screw Products Inc.
3917 N. Kedzie Ave. Chicago 18, Ill.

I Bought My Wife a Sports Car with the EXTRA MONEY



I learned in Mobile-Radio Maintenance!

Sure, an engineer's pay is good—but mine just wouldn't stretch far enough to give my family all the nice things they deserve. So in my spare time I'm servicing commercial mobile-radios in my home town. And I'm mighty proud to think of my wife driving that new Thunderbird!

This can be your story, too. Send coupon for your free copy of "HOW TO MAKE MONEY IN MOBILE-RADIO MAINTENANCE." Published by Lampkin Laboratories, Inc., manufacturers of the 105-B Micrometer Frequency Meter & 205-A FM Modulation meter. Easy monthly payment plan available!



105-B

205-A

LAMPKIN LABORATORIES, INC.
Instruments Div., Bradenton, Fla.

At no obligation to me please send "HOW TO MAKE MONEY IN MOBILE-RADIO MAINTENANCE."

Name _____
Address _____
City _____ State _____

Want more information? Use post card on last page.
ELECTRONICS — March 1, 1957

the like. With this foundation, he proceeds to show the varied applications of these fundamental processes.

The applications discussed include, to mention a few, audio; radio communication and broadcasting; radio navigational aids and radar; television; switching, counting and computing; industrial electronics and instrumentation. The profusion of block diagrams and simplified schematic diagrams greatly adds to the readability and understanding of these sections.

The descriptive style of this book recommends it for those interested in electronics who are limited by only a basic knowledge of electricity, but who want to know more about counters, rotary switching tubes, gating circuits and similar building blocks of our present-day electronic devices.—H.A.M.

Pulse and Digital Circuits

BY JACOB MILLMAN and
HERBERT TAUB.
McGraw-Hill Book Company, Inc.,
1956, 673 p, \$12.00.

DRS. Millman and Taub have produced a book which should prove extremely valuable to the practicing engineer in the field of nonlinear circuits, possibly more valuable even than to the undergraduate electronics student for which it is intended. The authors have done an admirable job of collecting and lucidly analyzing a large number of the basic circuits which are the tools of the engineer in this field.

The book starts with a review of amplifier circuits with particular emphasis upon the cathode follower and the operational amplifier. This is followed by material on linear wave shaping, linear pulse or video amplifiers and nonlinear waveshaping (a somewhat illogical grouping possibly). The chapter on linear pulse amplifiers is particularly impressive because of the relevance of the material chosen for presentation to practical design problems.

► **Waveform Generation** — A following group of chapters deals with waveform generation and describes various multivibrator circuits, time



NEED THE ABOVE?
NEED IT FAST?
SEE US FIRST!

Send for Our Catalog

For Technical Information, Prices & Deliveries Call

American Super-Temp Wires, Inc.

West Canal St., Winooski, Vt.
Burlington 2-9636

General Sales Office • Princeton, N. J.
Princeton 1-4450

➔ A Few Choice Territories Still Open
For Qualified Representatives.

Want more information? Use post card on last page.

an industrial instrument for counting electrons

The Beckman Model V
Micro-Microammeter — panel-
mounted for console or rack



In an increasing number of technical fields, currents as low as a few thousand electrons per second are today too important to leave unmeasured. For the exacting demands of these critical precision applications, Beckman offers the instrument proved through leadership in nuclear technology: the Model V Micro-Microammeter. It is sensitive enough to measure a millionth of a millionth ampere — full-scale. And reliable enough for reactor control. Write for Data File P-1-58, to Process Instruments Department, Beckman Instruments, Inc., Fullerton, Calif.



With the Exclusive Beckman Vibrode® sealed, nitrogen-cushioned, vibrating-reed modulator

Model V Specifications

Detection range: Choice of 13 ranges between 3×10^{-13} and 3×10^{-7} ampere. **Accuracy and reproducibility:** $\pm 1\%$ on all ranges. **Stability:** Less than 1 uv zero drift in 24 hours. Unaffected by line voltage fluctuations between 103-127 volts. **Indication:** Dual-calibrated, $4\frac{1}{2}''$ scale. **Response time:** Time constant (4.0 to 0.12 seconds) varies with input capacity. **Warmup time:** Amplifier, 3 to 5 minutes. Isothermal shield, 30 minutes.

Beckman®

Process Instruments
Beckman Instruments, Inc.
Fullerton, California

PIX

DEPENDABLE, PRECISION WIRE FORMING AND STAMPING SPECIALISTS

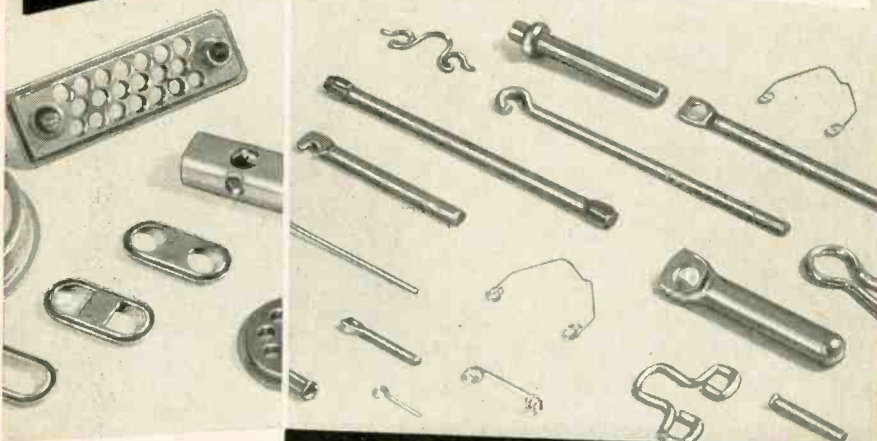

**PIX Manufacturing
Co., Inc.**

81-A Hudson St.
Newark 3, New Jersey

Precision parts from PIX to meet your production and engineering needs—from .002" dia. to .125" dia. Modern facilities, high-production equipment. Radio tube parts, drawings, piercing, wire straightening, cutting and forming, relay components, transistor bases, terminal lugs, multislide stampings, beryllium copper contacts and printed circuit connectors.

Send sketch or print for quotation.

base generators and blocking oscillators. The operation of numerous specific circuits is explained, analyzed and their application discussed. Blocking oscillator operation is treated in considerable detail.

The characteristics of distributed and lumped parameter delay lines are discussed as are some delay line applications including their use in distributed amplifiers. There is considerable discussion of counting and frequency-division methods in which again the operation of numerous specific circuits is explained including the use of binary counters with feedback, blocking oscillators, multivibrators and phantastons.

► **Computer Circuits** — A chapter on fundamental digital computer circuits describes various building blocks such as the OR, AND, NOT circuits, shift registers, inhibitor circuits, etc. There is a too short discussion of magnetic binary elements and their application. Various transmission gates, voltage comparators, and time modulation and measurement means are discussed and analyzed.

The chapter on pulse and digital systems is, in our opinion, incomplete since the authors have chosen to discuss only television and radar as examples of pulse and digital systems leaving out any discussion of actual digital computation systems. We realize that a detailed discussion would require at the least another book the size of this, but a discussion of the principles involved and examples of how some of the circuits described in previous chapters are combined to perform the necessary operations would not have been amiss.

► **Transistors** — The book concludes with an excellent chapter on transistors which includes some semiconductor physics, a discussion of the fundamentals of transistor operation and the application of the transistor to linear and nonlinear circuits.

As can be seen from the foregoing the book is primarily a compendium of circuits with explanations and analyses. Because of this we must take issue with the au-

thors' recommendation of the book as the concluding course in a sequence of three undergraduate electronics courses. It is our strong feeling that the student's time would be better spent learning more of the fundamentals of circuit design and analysis than can possibly be taught in two courses. We share the authors' preference for four undergraduate electronics courses in which case "Pulse and Digital Circuits" would serve admirably as a text for the final course.—L. L. POURCIAU, *General Precision Lab. Inc., Pleasantville, N. Y.*

Handbook of Semiconductor Electronics

BY L. P. HUNTER.
McGraw Hill Book Co., Inc., New York, 1956, 832 p, \$12.00.

THIS VOLUME is a book of slightly over 800 pages, which is not large compared to many other handbooks, but does manage to deal with most aspects of this field in varying degrees of completeness and detail. It consists of four Parts and 20 Sections, as well as an excellent bibliography and essentially complete and well organized author and subject indices.

► **Parts I and II**—Entitled "Physics of Transistor Diodes and Photocells" and "Technology of Transistor, Diodes and Photocells", the subjects covered in these sections range from electronic conduction in solids through transistor action, and from preparation of semiconductor materials through device design considerations. L. P. Hunter has contributed all of Part I, as well as Section 10 of Part II. Such well known names as H. F. Priest and W. C. Dunlap, Jr. are responsible for other sections.

The intentions of these Parts are for "... the one purpose of supplying only those principles needed to understand the mechanisms of transistor and diode action" and "... to provide the engineer with a basic understanding of the limitations imposed upon the finished devices by the various methods of fabrication." Within these limitations, as stated in the prefaces, the

Those in the **KNOW** don't gamble . . .

they specify

CORNISH

Electronic

WIRES and CABLES

Since the very birth of Radio, the ace-high standard for comparison! Write for our new catalog of Wire Products, including:—

T-V LEAD-IN CABLES • MICROPHONE CABLES
INTERCOMMUNICATION CABLES
SHIELDED INTERCOMMUNICATION CABLES

Custom **CORD SETS**

Designed and manufactured to your requirements. Leading producers of Electronic Equipment and Appliances choose CORNISH, for better and LONGER service on the job . . . they're GLUTTONS for punishment.

"MADE BY ENGINEERS FOR ENGINEERS"

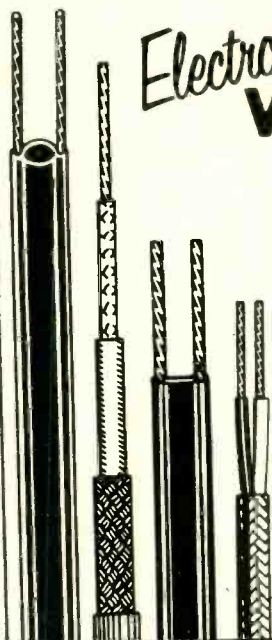

CORNISH WIRE COMPANY, INC.

50 Church Street

New York 7, N. Y.

DEFLECTION YOKES

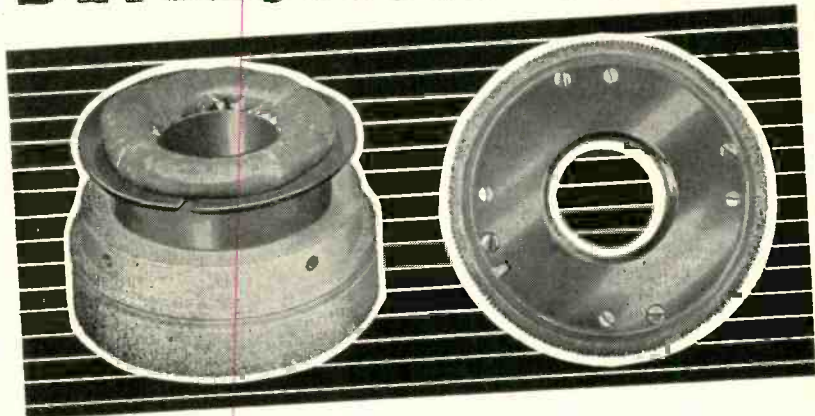

We specialize in the design and manufacture of precision deflection yokes for military and commercial applications. Phone or write for immediate engineering evaluation of your critical display problems.

Celco

Phone: RAMsey 9-1123

Constantine Engineering Laboratories Co.

Island Avenue

Mahwah, N. J.

NEW!

**DC to DC and DC to AC
solid-state power converters
voltage regulated, frequency
controlled, for missiles,
telemetry, gyros, servos**

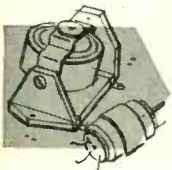
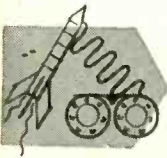
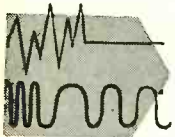
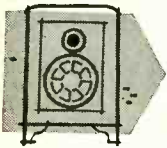
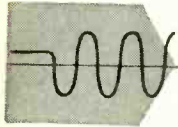
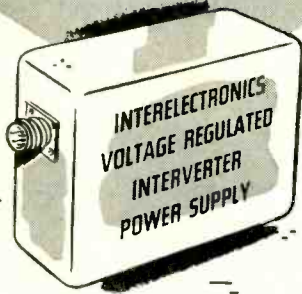

Interelectronics Inverter solid-state thyra-tron-like elements and magnetic components convert DC to any number of voltage regulated or controlled frequency AC or filtered DC outputs from 1 to 1800 watts. Light weight, compact, 90% or better conversion efficiency.

Ultra-reliable in operation, no moving parts, unharmed by shorting output or reversing input polarity. Complies with MIL specs for shock, acceleration, vibration, temperature, RF noise.

Now in use in major missiles, powering telemetry transmitters, radar beacons, electronic equipment. Single and polyphase AC output units now power airborne and marine missile gyros, synchros, servos, magnetic amplifiers.

Interelectronics — first and most experienced in the DC input solid-state power supply field, produces its own solid-state gating elements, all magnetic components, has the most complete facilities and know-how—has designed and delivered more working KVA than any other firm!

For complete engineering data write Interelectronics today, or call LUDlow 4-6200 in N. Y.

INTERELECTRONICS CORPORATION

2432 GR. CONCOURSE, N. Y. 58, N. Y.

Want more information? Use post card on last page.

NEW BOOKS

(continued)

results are admirable and the range of subjects is entirely adequate for the purpose.

The emphasis on energy level diagrams and the neglect of the somewhat more familiar symbolic structures, may make Part I somewhat difficult reading for non-physicists. It is also unfortunate that no information on radiation effects is included. However, once it is understood that Parts I and II are not intended to serve as specifically handbook material, it may be stated that the combination of Parts I and II makes an excellent introduction to the general problems and characteristics of device design.

These parts are recommended to the circuit designer as a desirable adjunct to his knowledge of the circuit characteristics of these devices.

► **Part III**—Containing the "red meat" of this book, this part approaches closest to meeting the requirements one might wish to put on a handbook. A generally successful attempt is made in most sections to provide design information for the subjects under discussion.

The weakness in Part III lies in the tendency in some sections to depend too much on descriptive material and not enough on tables, monographs, lists of significant equations, graphs, etc. The sections on oscillators and special semiconductor devices are probably least satisfactory from this point of view.

The sections on low-frequency amplifiers, d-c amplifiers, and switching circuits are closest to what may be termed the ideal handbook structure, but also suffer to some extent from an excess of discursive treatment and an insufficiency of the sort of design aids a handbook should provide to justify its title, if not its existence.

A few specific instances of success and partial failure from this point of view may be adduced. H. J. Woll, in Section 11 on low-frequency amplifiers, is to be complimented on the yeoman work he has done in trying to bring some order out of the chaos into which the transistor equivalent circuit situation has begun to deteriorate. How-

RAWSON-LUSH Rotating Coil GAUSSMETER

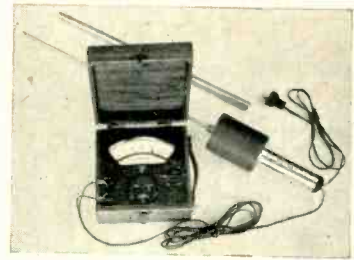

Tiny coil (approx. 3 mm diameter) rotates in the field to be measured. The voltage generated is rectified in a synchronous rectifier and used to deflect a Rawson high sensitivity voltmeter with scale calibrated in kilogausses.

Features

- (1) Simple operating principles, simple to use and maintain.
- (2) Compact and portable, just one meter and the long probe unit.
- (3) Ranges 0.4 — 1.2 — 4 — 12 — 40 — 120 kilogausses, all in one instrument.
- (4) Practically point measurement of magnetic field.
- (5) Can be inserted in any gap larger than 1/4" and will reach center of 37" diameter gap. Coil protected by stationary outer tubing.
- (6) Measures direction of field as well as intensity.
- (7) Guaranteed accuracy 1 per cent or better.
- (8) Low Price \$375.00 complete with meter.

**RAWSON ELECTRICAL
INSTRUMENT COMPANY**

111 Potter St.

Cambridge, Mass.

How To Get Things Done Better And Faster

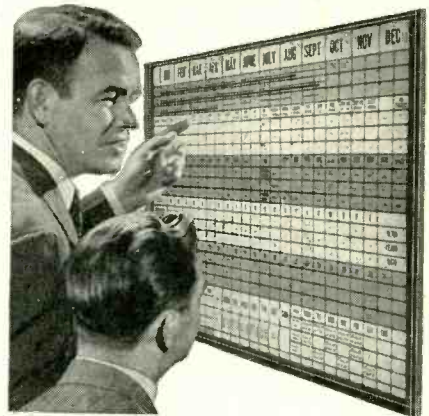

BOARDMASTER VISUAL CONTROL

- ☆ Gives Graphic Picture — Saves Time, Saves Money, Prevents Errors
- ☆ Simple to operate — Type or Write on Cards, Snap in Grooves
- ☆ Ideal for Production, Traffic, Inventory, Scheduling, Sales, Etc.
- ☆ Made of Metal Compact and Attractive. Over 100,000 in Use

Full price **\$4950** with cards

FREE

24-PAGE BOOKLET NO. C-30

Without Obligation

Write for Your Copy Today

GRAPHIC SYSTEMS

55 West 42nd Street • New York 36, N. Y.

Want more information? Use post card on last page.

March 1, 1957 — ELECTRONICS

DOUBLE DISC GRINDING

Our Double Disc Grinders
SPEED PRODUCTION
and **SAVE \$\$\$**

by grinding 2 surfaces Flat
and Parallel in one opera-
tion.

**TOLERANCES IN
LOW TENTHS**

Piece parts may be rectan-
gular or round flat discs, or
flimsy castings in any mate-
rials. All parts are inspected
in our air conditioned in-
spection room—equipped to
measure in "millionths."

We service customers from
Maine to California

WRITE for BROCHURE

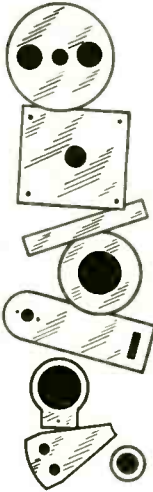

PRECISION DISC GRINDING CORP.

57 MESEROLE AVE., BROOKLYN 22, N. Y.
PHONE: EV 3-3720

NEW CHRISTIE SILICON POWER RECTIFIERS



For Top Reliability

- A standard line from 30 to 1000 amps
- Closely regulated by magnetic control
- Voltages: 8-16-32-36
- Stationary or Mobile Types
- For Missile, Aircraft, Lab & Factory

Write for Latest Bulletins on
Silicon & Selenium Power Rectifiers

CHRISTIE ELECTRIC CORP.

Dept. EL, 3410 W. 67th St., Los Angeles 43

Over a Quarter Century of
Rectifier Manufacturing

DUST CONTROL EQUIPMENT

PROTECTIVE GLOVES developed by Victor
Gloves, in collaboration with Bell Telephone
Laboratories, and are currently being used
by the laboratories in the assembly of
select devices sensitive to physical and
chemical contamination. The gloves are
made from lint-free and fiber-free
materials.

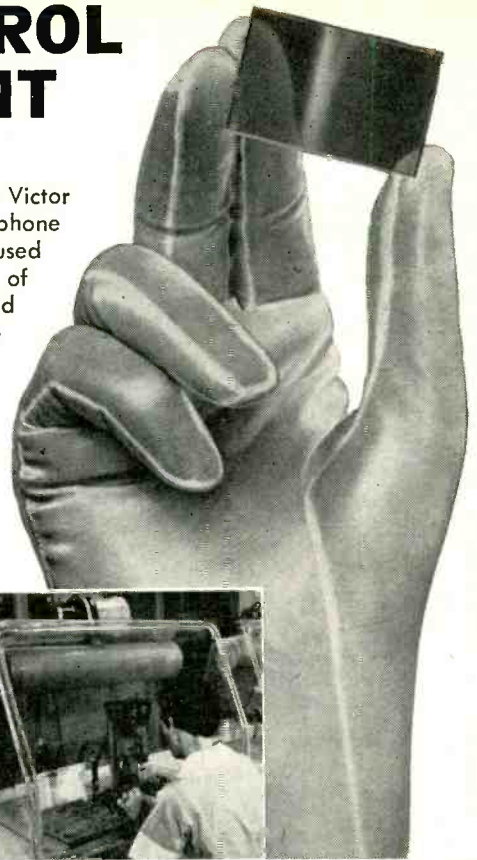

Low Humidity Dry-Boxes
in stainless steel or trans-
parent plastic.

We also design and fabricate
special equipment such as Inert
Gas Hoods, Specialized Con-
tamination and Atmosphere
Control Equipment in stainless
steel or plastic to meet your in-
dividual requirements.

No. 25 Transparent
pressurized
dust control hood



P. M. LENNARD COMPANY, INC. Dept. E

P. O. BOX 56, VILLAGE STATION, N. Y. 14, STERLING 9-2420

(See our exhibit at the I. R. E. Show, Coliseum, Booth 4130)

IMPREGNATING
SEALING
DIPPING
INSULATING
BLENDING



POTTING
HEAT CONDUCTING
MOISTURE PROOFING
FUNGUS PROOFING
ENCAPSULATING

WAXES BIWAX COMPOUNDS

Standard compounds available from stock.

Samples and specifications on request.

Modifications developed and produced to meet specific requirements.
Information relating to your problem will enable us to make recom-
mendations. Write to

BIWAX CORPORATION

3445 HOWARD ST.
SKOKIE ILLINOIS

SILK SCREENS

from your finished art or sketch

- ★ CERAMIC CAPACITORS
- ★ PRINTED CIRCUITS
- ★ SCHEMATICS

SILK OR WIRE MESH SCREENS TO TOLERANCES OF .001 FOR PRODUCTION RUNS.
SHIPPED 48 HOURS ON RECEIPT OF ART. WRITE FOR ESTIMATES.

bollling Industries

1117 N. MAIN AVE.
INC. SCRANTON 2, PA.

ADVANCED DESIGN

new...PRECISION "POT" by GENERAL CONTROLS

PRM 123

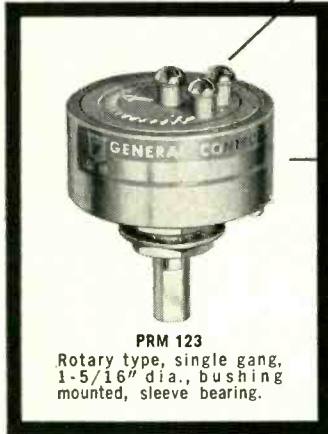

PRM 123
Rotary type, single gang,
1-5/16" dia., bushing
mounted, sleeve bearing.

General Controls, famous for 25 years as a supplier of mechanical and electro-mechanical controls for home, industry and the military... proudly announces a new product of its Potentiometer Division...

FEATURES...

- Variations from 100 to 50,000 ohms resistance.
- Standard tolerances $\pm 3\%$ resistance, $\pm 0.3\%$ independent linearity.
- Exceeds MIL-R-12934, -E-5272A Specs.
- Explosion-proof, or dust-tight seals.
- Operating temperatures are -65°F . to 275°F .
- Special Spec. Models Available.

Write for 1956 Catalog!



GENERAL CONTROLS

POTENTIOMETER DIVISION

Glendale 1, California

Factory branch offices serving all principal cities of the United States and Canada

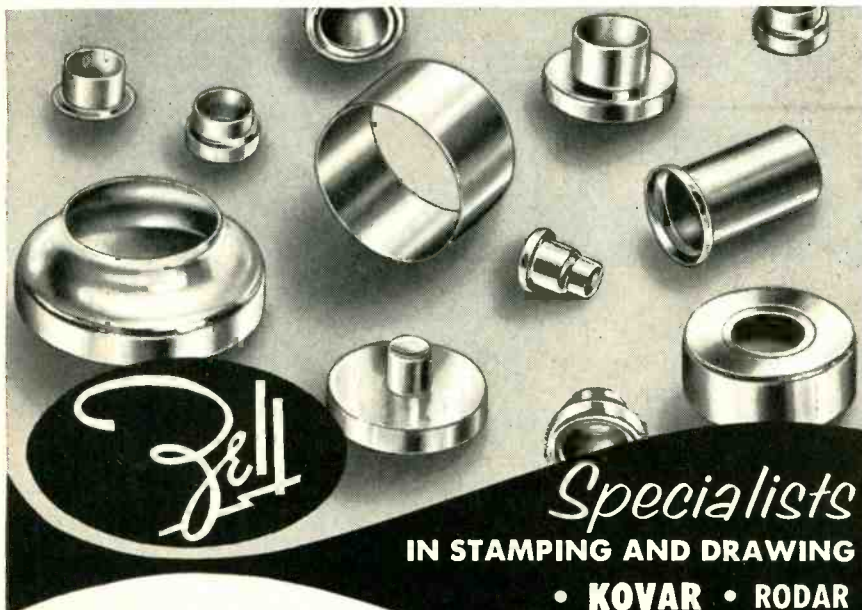

Specialists IN STAMPING AND DRAWING

- KOVAR • RODAR
- THERLO • FERNICO
- Other IRON-NICKEL-COBALT Alloys

COMPLETE FACILITIES FOR PRECISION PRODUCTION OF ELECTRONIC COMPONENTS

Our facilities are geared to meet your production and engineering needs for components of any description. Unusually Complete Tool Room • Press Shop • Hydrogen Annealing, Machining and Polishing Operations • Glass-to-Metal Hermetic Sealing. Production of completed parts ready for assembly in your own plant.

A complete service in our plant means prompt service to your plant.

CUT TOOLING COSTS!

Over 3,000 high precision tools and dies available to reduce your initial tooling time and costs.

Call on us for free consultation and quotations.



ZELL PRODUCTS CORP.
279 Main Street, Norwalk, Conn.

ever, both the class B power amplifier and operating point stabilization discussions seem inadequate.

This reviewer can state, unequivocally, that stabilization against both device and temperature variations is of far more significance than the limited treatment in the text might lead one to believe. For example, the equation at the bottom of p 11-53 seems as though it should be $I_c \cong [I_{c0} + E_c / (R_b + R_c)] / [1/h_{cb} + R_c/R_b]$, but without more information about the author's assumptions it is impossible to verify this.

The presentation of regulated power supplies in Section 13 on d-c amplifiers by C. Hurtig is also inadequate for design purposes. A much more elaborate exposition is necessary to prepare the circuit designer for dealing with this problem.

► **Oscillators**—Most of Section 14, by E. Eberhard, on oscillators, is devoted to point contact types. The treatment of junction, crystal and nonsinusoidal circuits is little more than a cursory introduction. A more complete description of nonsinusoidal types is included in Section 15 by J. C. Logue on switching circuits, but does make up for part of this lack. This latter section is the longest single section and contains a great deal of useful and well organized information on both switching and logical circuits. However, it is perhaps unfortunate, in view of the trend to junction transistors, that so much space is used for point contact transistor circuits, while no junction transistor regenerative amplifier is included.

Section 12, by J. B. Angell, on high-frequency and video amplifiers is largely unexceptional and is essentially limited by the general lack of knowledge. The same comment might be made about George H. Royer's treatment of circuits using special semiconductor devices.

► **Part IV**—The "Reference Material" consists of two sections by H. Fleisher applying familiar techniques of graphical and matrix analysis to the specific problems of transistor circuits and two sections

by G. Knight, Jr. and J. C. Logue on measurement of semiconductor and semiconductor-device parameters. This is not reference material in the usual handbook sense, but does provide an understanding of the methods whereby the analytical and empirical material of previous sections was obtained.

► **Conclusion**—A few editorial or proof reading lapses may be found in this book. These include the absence of numbering for the equations in Section 10 and the repetition in Section 13 of some of the material covered in Section 10, without establishing a proper relationship between the symbols and formulas used in the two sections.

The same stricture might be applied to Sections 17 and 18 on analysis. It was also surprising to find no discussion of the *pnip*, *npin* transistors and no reference to J. M. Early's article on junction transistor design at the end of Section 10 on device design considerations.

However, considering the gargantuan task involved, one can have nothing but praise for the general coherence and readability of the result of L. P. Hunter's editorial labors. While it is not the ultimate semiconductor electronics handbook, this is not surprising considering the newness of the subject and the rapid advances still being made.

As another entry in the still inadequate group of transistor texts, this volume has a great deal to commend it. Therefore the inadequacies mentioned above do not denigrate it and may be condoned in terms of an ambitious undertaking which succeeds far more frequently than it fails.—SOL SHERR, *General Precision Lab., Inc., Pleasantville, N. Y.*

Thumbnail Reviews

Elements of X-ray Diffraction. By R. D. Cullity, Addison-Wesley Publishing Co., Reading, Mass., 1956, 514 p., \$10.00. A student's book of solid-state X-ray diffraction principles and

UNEQUALED PERFORMANCE

IN

- TELEMETERING
- GUIDED-MISSILE MONITORING
- RADIOSONDE RECEPTION

This Special Purpose Receiver is an improved version of the NEMS-CLARKE 167-J1 and 167-J2. This new Receiver incorporates the best qualities of both of the former types plus many new features including a BFO. A video bandwidth control is provided to greatly improve signal-to-noise ratio when full bandwidth is not needed. It is especially useful as a high quality general purpose laboratory receiver.

NEMS-CLARKE

INCORPORATED

919 JESUP-BLAIR DRIVE
SILVER SPRING, MARYLAND

For further information write
Dept. H-8



TYPE 1501 SPECIAL PURPOSE RECEIVER

SPECIFICATIONS

Type of reception.....	AM, FM, or CW
Tuning range.....	55-260 mc
IF bandwidth.....	300 kc
Sensitivity (measured without band-restricting filters).....	8 uv produces at least 23 db S/N ratio with 100-kc deviation, 400-cycle modulation.
Noise figure.....	11 db, maximum
IF rejection.....	Not less than 70 db
Image rejection.....	Not less than 40 db below 130 mc; 30 db minimum at any frequency.
FM output.....	0.15 volt per kc deviation (Approx.)
AM output.....	12 volts for 10 uv input modulated 30% at 1000 c.p.s. (Approx.)
Squelch.....	Operates on monitor circuit

Now you can

solder as easy
as you write!

—with

HEXACON INSTRUMENT SOLDERING IRONS

—for fast soldering and
long life on constant duty

Because of new efficient design, these tiny tips out-perform irons with larger tips and higher wattages. HEXACON offers a new standard in soldering iron efficiency for every conceivable need in the soldering of miniature assemblies.

Send for new circular No. 127 giving more details and comparative competitive performance data.

20Z.

SUPER-PENCIL IRONS*
No. 25S 25w. 1/8" tip \$6.00
No. 26S 30w. 3/16" tip \$6.00

30Z.

**BANTAMWEIGHT
HATCHET IRONS***
No. 25H 25w. 1/8" tip \$6.50
No. 26H 30w. 3/16" tip \$6.50

30Z.

**PIN-POINT
IRONS***
No. P-25A 25w. 1/8" tip \$6.00
No. P-26 30w. 3/16" tip \$6.00

* Also available in higher wattages



HEXACON ELECTRIC COMPANY
130 West Clay Ave., Roselle Park, New Jersey

Dress Up Your Products

with these

NEW KNOBS



Designed by
Robert Podall

These new knobs feature decorative metal inserts, in a choice of chrome, copper, satin brass and gold. Available in a variety of thermosetting materials, both phenolic and urea. Send for details.

ROGAN BROTHERS

8031 N. Monticello Ave., Skokie, Illinois

methods covering X-rays and crystal structure, followed by treatments of the theory of diffraction, experimental methods and applications. Electron and neutron diffraction are discussed in an appendix. Other appendices contain many numerical constants useful in this work.

Elements of Radio, Third Edition. By Charles I. Hellman, D. Van Nostrand Co., Inc., Princeton, N. J. 1956, 354 p., \$4.95. Up-to-date introductory text for high school students starts with fundamentals and leads up to such relatively sophisticated topics as transistors and television.

Studien über einkreisige Schwingungssysteme mit zeitlich veränderlichen Elementen. By Bruno Rudolf Gloor, Verlag Leemann, Zurich, Switzerland, 1955, 236 p. Analytical and experimental investigations of the theory and applications of the super-regenerative receiver.

Studien über Traveling-Wave Tubes. By Gerhard E. Weibel, Verlag Leemann, Zurich, Switzerland, 1956, 93 p. Theoretical analysis of traveling-wave tube as an active eight-terminal network and description of demountable experimental tube.

The Art and Science of Protective Relaying. By C. Russell Mason, John Wiley & Sons, Inc., New York, 1956, 410 p., \$12.00. Introductory text to basic principles of relay design and application to all elements of a power system against abnormal operating conditions. One of a series by General Electric authors.

Management Control in Aircraft Subcontracting. By Niel E. Harlan, Harvard Business School, Division of Research, Boston, 1956, 256 p., \$4.00. Problem of reestablishing the control system that is disrupted when a part of a production job is lifted from the plants of a prime contractor and placed in the hands of an outside company under a subcontract arrangement.

Symposium on the Application of Transistors to Military Electronics Equipment. Committee on Electronics, Office of the Secretary of Defense, Nov. 1953, 508 p., \$5 (paper). Thirty-two papers mainly concerned with fabrication of transistors by laboratory or pilot-line techniques or combinations of both. May be ordered from OTS, PB 111680 U. S. Department of Commerce, Washington 25, D. C.

The Oscilloscope at Work. By A. Haas and R. W. Hallows, Philosophical Library, New York, 1954, 171 p., \$10.00. Practical guide to application of oscilloscope to investigation of radio and tv circuits. Text is profusely illustrated with waveforms. Book is expanded version of French "L'Oscillographe au Travail".

Little Mag says:



**ENGINEERS-THERE IS ONLY
ONE UNITIZED RECTIFIER®
IT'S MAGNATRAN THE PACKAGE
WITH A PURPOSE**

Why not be the satisfied, worry-free Engineer who has provided for his company's own security, progress and savings? . . . You, too, can be the one to "choose and use"—Unitized Rectifiers®.

For AM, FM, TV and "over the horizon" transmitters— for Radar and Guided Missile Tracking — Hi-Voltage D. C. Equipment

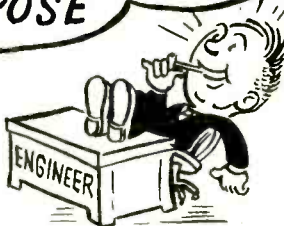

Magnatran Unitized Rectifiers® are built in sizes to 500 KW capacity and to 250 KV, DC output — dry type — oil or Askarel.

One Delivery—

Already Assembled—

Unitized!!



Write for details—Ask for New Bulletin 57-00-A



MAGNATRAN incorporated
P.O. Box 211 KEARNY, NEW JERSEY, U. S. A.

DANO COILS

BUILD "Customer Confidence"

From making the most precision coils required in electronically operated relays, timers, switches and devices to meeting most exact specifications of coils for high temperature application—*Dano Coils Build Confidence.*

- Encapsulated coils . . . in either polyester or epoxy resins.
- Coils for high temperature applications.
- Bobbins coils.
- Paper section coils.
- Cotton interweave coils.

TRANSFORMERS MADE TO ORDER



YOU CAN SAVE
UP TO **50%** ON
SMALL PARTS LIKE THESE

by using
TRADEMARK

BEAD CHAIN Multi-Swage PRODUCTS

Every year Bead Chain produces *billions* of tubular metal parts for electronic and mechanical applications. Multi-Swage eliminates costly turning, drilling, stamping and forming—automatically swages from flat stock into strong precision forms with positive, tight seams. If you're a volume user of such parts, in any metal, up to 1/4" diam. x 1 1/2" long, find out how much Multi-Swage can save you. Send sketch or standard parts for prompt estimate. Write for catalog today.



THE BEAD CHAIN MANUFACTURING CO.
88 Mountain Grove St., Bridgeport, Conn.

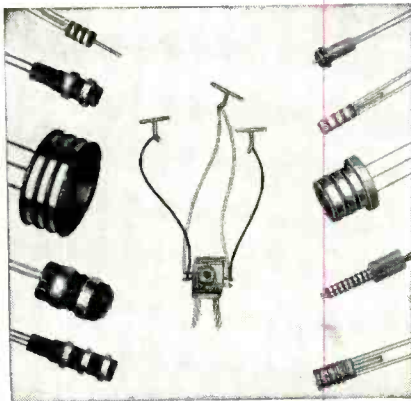

Miniature and Sub-Miniature
SLIP RING ASSEMBLIES
BRUSH BLOCK ASSEMBLIES
COMMUTATORS

and other
Electro-Mechanical Components

PRECISION MADE
TO YOUR OWN SPECIFICATIONS

Precision molded products with exacting tolerances in precious and non-precious solid metals of all alloys. All types of Thermo-Plastic and Thermo-Setting materials.

Slip Ring Assemblies fabricated or one-piece precision molded to your specifications in Nylon, Kel-F, Mineral filled Mellamine, Phenolic, and other materials. Rings and leads spot welded or brazed together for positive electrical circuit.

Our Swiss methods and techniques are geared to meet exacting requirements. We invite your inquiries.

COLLECTRON CORPORATION

Murray Hill 2-8975 • 216 East 45th Street • New York 17, N. Y.

NOW we can meet the
demand for

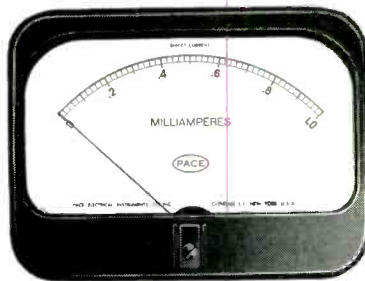

METERS!
2" TO 7" SIZES

Expanded plant . . . increased staff . . . New, improved automation techniques . . . to meet the demand of electronic equipment manufacturers for custom produced panel meters, in production quantities.

PACE meters are manufactured under rigidly controlled climatic conditions to meet critical specifications as to sensitivity, resistance, damping, response time, illumination, scaleplate design, etc.

Send for latest illustrated catalog, available upon request.
Write, wire or phone for applications engineering, consultation and assistance!

PACE ELECTRICAL INSTRUMENTS CO., INC.

a Division of Precision Apparatus Co., Inc.
70-31 84th Street, Glendale 27, L.I., N.Y.
Export: Marhan Exporting Corp., 458 Broadway, N.Y. 13, N.Y.

NOW...

a new Sylvania Standard Line of Long Life Power Transformers

Brought about by the request of a national research laboratory taking a prominent part in the National Defense Program, Sylvania is now making available a line of transformers with the following user benefits:

- (1) Ability to apply to multi-purposes (80% of the electronic power circuitry done today can be handled with the 34 types offered by Sylvania).
- (2) Users can obtain an *almost limitless combination* of voltages.
- (3) These transformers will operate on *both* 50 cycle and 60 cycle.
- (4) With Sylvania's design, the transformer bracket, cover of can, and chassis mounting flanges are all *one-tooled piece*.
- (5) All units contain *electrostatic* and *magnetic* shielding.
- (6) Construction is *leakproof*—cast with thermo setting epoxy resins.
- (7) Special terminal design features *non-twist* type (hot tin-dipped brass that also increases transformer life).

The Multi-Purpose Standard Line includes:

Plate • Combination • Filament
Filament isolation • Line isolation

Specific information regarding your particular requirements will be supplied upon request.

SYLVANIA ELECTRIC PRODUCTS INC.
Ipswich, Mass.

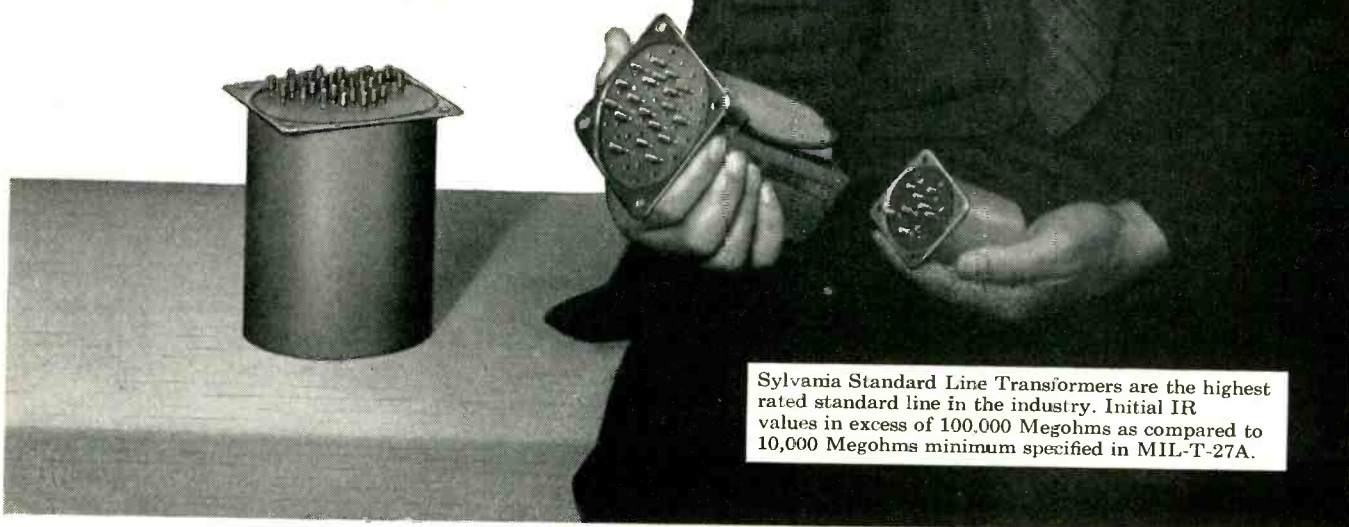

Sylvania Standard Line Transformers are the highest rated standard line in the industry. Initial IR values in excess of 100,000 Megohms as compared to 10,000 Megohms minimum specified in MIL-T-27A.



SYLVANIA

... fastest growing name in sight

LIGHTING • RADIO • ELECTRONICS • TELEVISION • ATOMIC ENERGY

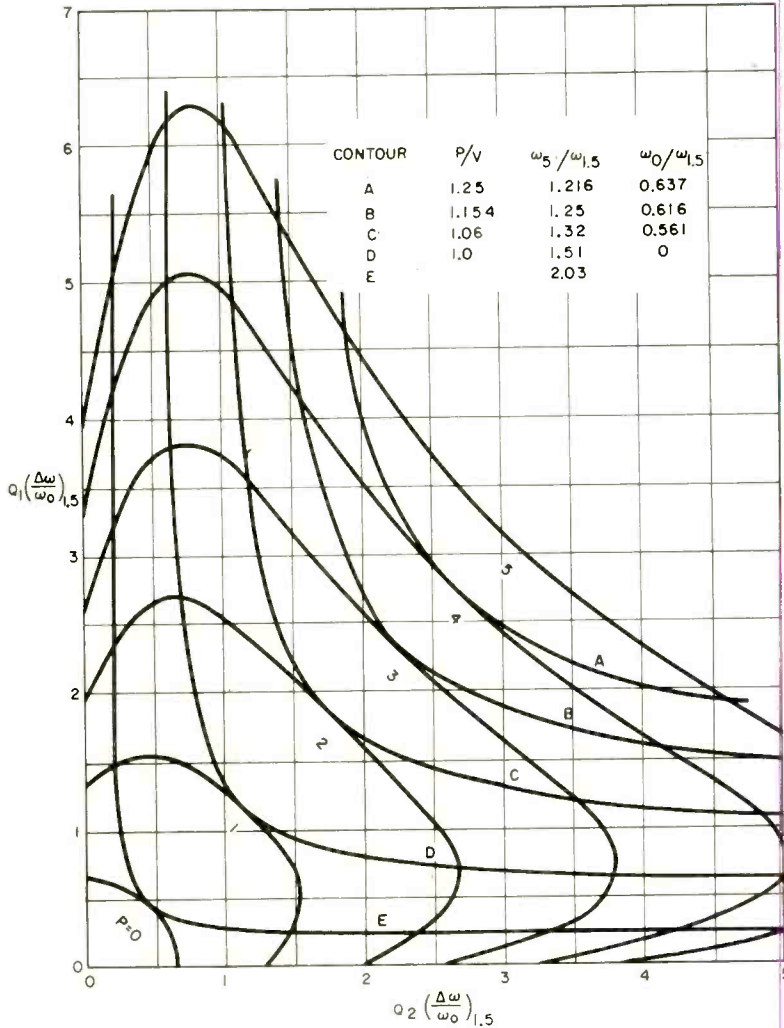

Transformer Curves for Reference Sheet

DEAR SIRs:

We found the article, "Design Charts for Tuned Transformers," which appeared on p 182 of the November 1956 issue, of great interest. Unfortunately, the curve shown for Fig. 5 is identical to that shown as Fig. 2. Would it be possible to print the correct Fig. 5 in a future issue?

Your publishing work is very much appreciated in Japan, especially in the area of automation and peaceful uses of atomic energy. ELECTRONICS is a great help to us in studying transistor circuits. It gives us practical and useful suggestions in our major fields.

We hope your editing and pub-

lishing activities will be greatly expanded in the future.

TOMOHIKO SUZUKI
Research Division
Iwasaki Communications Apparatus Co.
Tokyo, Japan

Editor's note: For Mr. Suzuki and other readers, the correct Fig. 5 is shown above.

Gravity Hypothesis

DEAR SIRs:

THE explanation for gravity proposed by Littell (ELECTRONICS, March, 1956) is not a true explanation in that, when examined carefully, it results in an observable modification of existing law.

The description of the universe

"TEKAP"—TABPAK®

HIGH CURRENT POWER SUPPLIES

One Year Guarantee

Variable 0-28 VDC. Completely Built. Ready to go. Full Wave Selenium Rectifier, Transformer, Variable Volt & Amp Meters, Switch, Terminals & Fuse. Hvy Duty Steel Cabinet Std 115V/60cy Input or 220V (3 phase) to order.

Stock NUMBER	Rating	Continuous	With Meters
T28V5A*	0-28VDC at 5 Amp		\$57
T28V5ACC	5 Amp (1% Ripple)		\$95
T28V5ACC	5 Amp (0.01% Ripple)		\$135
T28V12A	0-28 VDC at 12 Amp		\$138
T28V12ACC	12 Amp (1% Ripple)		\$175
T28V12ACC	12 Amp (0.01% Ripple)		\$250
T28V24A	0-28 VDC AT 24 Amp		\$175
T28V24ACC†	24 Amp (1% Ripple)		\$250
T28V24ACC	24 Amp (0.01% Ripple)		\$345
T28V50A†	0-28VDC at 50 Amp		\$325
T28V50ACC†	50 Amp (1% Ripple)		\$450
T28V100A†	0-28VDC at 100 Amp		\$550
T28V100ACC†	100 Amp (1% Ripple)		\$750

Variable 0-130 VDC Completely built. Ready to go. Includes F. W. Selenium Bridge Rectifier 4" Rectangular Volt & Ammeter. Specify for 115 or 230 VAC 1 phase 60 cy input.

T130V5ACC	0-130 VDC at 5 Amp	\$225
T130V5ACC	5 Amp (1% Ripple)	\$275
T130V10ACC	0-130 VDC at 10 Amp	\$275
T130V10ACC	10 Amp (1% Ripple)	\$335

* 2" Meters. All others 4" Meters 3% Accy.

LO-PRI BASIC DC POWER PACKAGES contain Transformer, Rectifier, Switch, Fuse, Terminals. Built on ventilated chassis.

B12V21A	12 VDC @ 24 Amp	\$96
B12V50A	12 VDC @ 50 Amp	\$138
B28V12A	28 VDC @ 12 Amp	\$93
B28V21A	28 VDC @ 24 Amp	\$135
B28V50A	28 VDC @ 50 Amp	\$265
B115V2A	115 VDC @ 2 Amp	\$83
B115V4A	115 VDC @ 4 Amp	\$144
B220V1.5A	220 VDC @ 1.5 Amp	\$150

CUSTOM POWER SUPPLIES TO YOUR SPECS WE INVITE YOUR INQUIRIES

New Variable 0 to 6 & 12 Volt

12 Amp DC Power Supply

Battery Eliminator Charger Model RR Plater Aircraft Marine or any DC Req. Extra Hvy Duty Selenium Rectifier, 2 Meters V. & A. Dgnd for Cont. Service and up to 20 Amp Intermittent overload. New Model T612V12ACC SPECIAL.

Model RR3000

Model RR3000

Model RR3000

Model RR3000

Model RR3000

Model RR3000

Model RR3000

Model RR3000

Model RR3000

Model RR3000

Model RR3000

Model RR3000

Model RR3000

Model RR3000

Model RR3000

Model RR3000

Model RR3000

Model RR3000

Model RR3000

Model RR3000

Model RR3000

Model RR3000

Model RR3000

Model RR3000

Model RR3000

Model RR3000

Model RR3000

Model RR3000

Model RR3000

Model RR3000

Model RR3000

Model RR3000

Model RR3000

Model RR3000

Model RR3000

Model RR3000

Model RR3000

Model RR3000

Model RR3000

Model RR3000

Model RR3000

Model RR3000

Model RR3000

Model RR3000

Model RR3000

Model RR3000

Want more information? Use post card on last page.

BIRNBACH - The "In Stock" Line . . .

ALL YOUR NEEDS FOR WIRE, CABLE, TUBING JACKS and PLUGS

COMPLETE CATALOGS ON REQUEST

New! TEFLON HIGH TEMPERATURE

HOOK-UP WIRE • CABLE • TUBING • SLEEVING

IRE SHOW
BOOTH
#4510

**MORE COLORS • MORE SIZES
MEETS ALL MIL/JAN SPECIFICATIONS**

JAN-C-76, MIL-W-76A, MIL-W-16878B, MIL-W-5086,
MIL-C-7078, MIL-W-12349, MIL-I-631C, MIL-I-3190,
JAN-T-713.

COMPLETE NEW YORK WAREHOUSE STOCKS

BIRNBACH RADIO CO. Inc.
145 HUDSON STREET
NEW YORK 13, N. Y.



Electrical Coil Windings

For 40 years . . . specializing in all types of coils to customers' specifications. Design or engineering assistance available on request.

COTO-COIL CO., INC.

SINCE 1917

65 Pavilion Avenue Providence 5, Rhode Island

MAGNETS

HIGH ENERGY
PRECISION
ALNICO
PERMANENT
MAGNETS

WE CARRY
IN STOCK
ALL SIZES,
ALL SHAPES,
ALL ALNICO
GRADES . . .

When you need them — as you need them. Experimental or production quantities.

PERMAG
services include:
• ENGINEERING
• PRECISION CUTTING
• PRECISION GRINDING
• MAGNETIZING

24 HOUR DELIVERY

Send for Catalog

PERMAG CORP.
210 TAAFFE PLACE, BROOKLYN 5, N. Y.
Phone: MAin 2-0114

BACKTALK

(continued)

under Littell's hypothesis can be studied mathematically and, if normalized to the observer, its analysis becomes quite simple. Omitting mathematical details, the reasoning follows.

The explanation allows two interpretations, either (1) the acceleration of the expansion is proportional to the gravitational force of a body, $r = kr^{-2}$ for a "point" source like the planets or the sun for $r >$ the radius of the object or (2) The space surrounding a gravitating mass expands as a "rigid" body with acceleration independent of distance and equal in magnitude to that of the surface of the mass.

The impossibility of reconciling alternative 2 with the actual universe is so evident that it will not be further considered. The sun's gravity would affect us 20 times as much as the earth's in every respect and we would either be crushed to the earth's surface during the night or else go shooting off toward the sun during the day.

The first possibility, if it did occur, could easily be detected in the laboratory and moreover would violate all astronomical observations. Since its contradiction to these observations would be most spectacular, we will examine this case especially.

The apparent size or diameter of objects depends linearly upon their true relative diameter and is inversely proportional to their distance from the observer. This is a simple fact from geometry and merely requires normalization with respect to the observer to be also true in Littell's universe.

For objects whose distance is great in proportion to their mass (so that the expansion of an orbit is small compared to that of the central body), like the sun, moon, and almost every other celestial object, the apparent size (relative to the earth) would, applying Littell's explanation, be proportional to the gravitational field of the object and would be either expanding (relatively) or contracting depending upon whether its gravity were respectively greater or less than ours.

This relative change could be detected in a matter of minutes and would eventually result in the moon shrinking from view and the sun

Can your business co-exist with 70 million captive people?

As long as an Iron Curtain shuts off the satellite countries of Europe, the framework and future of free enterprise will be in danger.

There is proof before us every day that the world can prosper fully only when men *everywhere* are free to choose their own way of life, build their own businesses and till their own land. Yet behind the Iron Curtain 70 million people are still virtual prisoners of the Communists.

There are a number of ways you and other American businessmen can help these people, yourselves and the world. One of the most direct is through Crusade for Freedom, sponsor of Radio Free Europe.

For six years, this powerful overseas broadcasting operation has been beaming the truth into five key satellite countries. It has been outstandingly successful.

The Communists have spent fabulous sums trying unsuccessfully to jam RFE's programs. The bill for this last year in Poland alone was estimated at \$17,000,000. *Two-thirds of this amount will support the entire RFE operation for another critical year!*

And we know from letters and reports that truth from Radio Free Europe has helped keep alive the desire for freedom. The proof is history.

So give your generous support to Crusade for Freedom in aiding these 70 million captives. If you don't send them the truth—who will?

Some ways business executives have helped. Check the ones you are interested in.

- Display Crusade material on your company bulletin board.
- Plan a paycheck stuffer to inform your employees of the importance of the Crusade for Freedom.
- Plan to conduct an in-company solicitation.
- Match employee funds with your Truth Dollars.



For campaign material

and information write **CRUSADE FOR FREEDOM,**

345 East 46th St., N. Y. C. 17.

growing until it covered the whole sky!

Littell's hypothesis could only be made consistent with our observations by denying the law of conservation of matter and the fundamental assumption, which underlies all physical science, that the universe is composed of classes of similar nonmultiplying particles which are the electrons, protons and so on.

Deny these fundamental assumptions and the very existence of science would be impossible.

FRANKLYN G. CREESE
California Forest and Range
Experiment Station
University of California
Berkeley, California

Dempa Gizitsu

DEAR SIRS:

AS a reader of *ELECTRONICS* and a student of the Japanese language here in Japan, I feel inclined to add my two yen worth of comment on the dempa gizitsu subject.

There are two main systems of transliterating the Japanese language into the Roman alphabet. They are the official government system, "Kunrei" (meaning "Orders") and the Hepburn system which is named after its founder, James C. Hepburn.

The two systems have somewhat conflicting aims. In the case of the Kunrei system, the intent is to maintain the regularity in spelling various conjugations of verbs etc. To this end it is necessary for the syllable pronounced SHEE to be spelled SI; TSOO is spelled TU; CHEE is TI; JEE is ZI; FU is HU and so forth, although many syllables are the same in both systems.

To most foreigners accustomed to the Roman letter equivalent in their own language, the Japanese Kunrei system is awkward. For instance the famous mountain of Japan is spelled HUZU although pronounced FOO-JEE. Because of this, the system has not been received with much enthusiasm by anyone, although serious students of the language will point out that it has certain definite advantages over the Hepburn system.

The Hepburn system attempts to

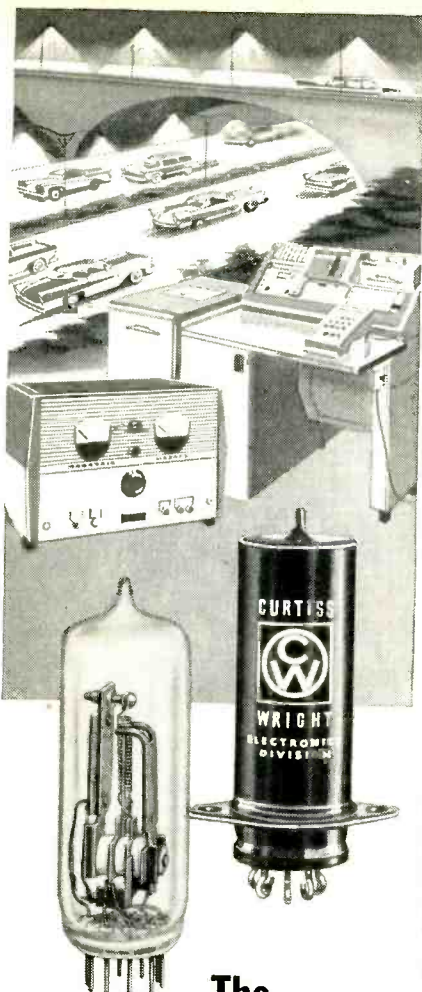

The Curtiss-Wright "SNAPPER"

Thermal Time Delay Relays
FOR COUNTLESS APPLICATIONS

- Eliminates chatter with snap action
- Single-pole, double throw contacts
- Wide ambient range (-65°C $+100^{\circ}\text{C}$)
- For military, commercial and industrial applications
- Metal envelope (7 or 9 pin) miniature or (8 pin) octal
- Glass envelope in 9 pin miniature
- Preset time delays in metal from 3 to 90 seconds, glass from 5 to 60 seconds

Write to Thermal Devices Department
for latest data sheets



SEE US AT BOOTH 1327 IRE SHOW

Want more information? Use post card on last page.

Ω
Omega
INDUSTRIES, inc.

36-39 171 ST. FLUSHING, N. Y.

SWISS SCREW MACHINE PARTS

CONTACT PINS

TERMINALS

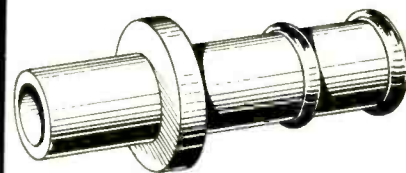

HIGH STANDARDS OF

PRECISION ACCURACIES

ON SWISS EQUIPMENT

NEW! ENGRAVED Rubber Dies and Stamps!

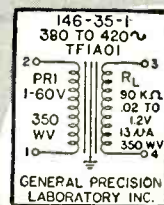

CLOG
RESISTANT

N
20

ACID
RESISTANT

134

LONGER
LASTING

• Now you can get clean, clear, sharp, even impressions everytime with Kregel Deep-Kut Engraved Rubber Dies and Stamps. Lasting impressions remain on metals . . . printed materials . . . textiles . . . glass . . . on any surface.

• We make Deep-Kut Engraved Rubber Dies and Stamps for every marking unit . . . any type style or logotypes. Anything you need in any quantity you desire.

Visit our Booth #4020
IRE Show at the Coliseum
March 18-21, 1957

KREGEL MANUFACTURING COMPANY
227 FULTON STREET, NEW YORK 7, N. Y.
TEL. CO 7-5712

Want more information? Use post card on last page.

March 1, 1957 — ELECTRONICS

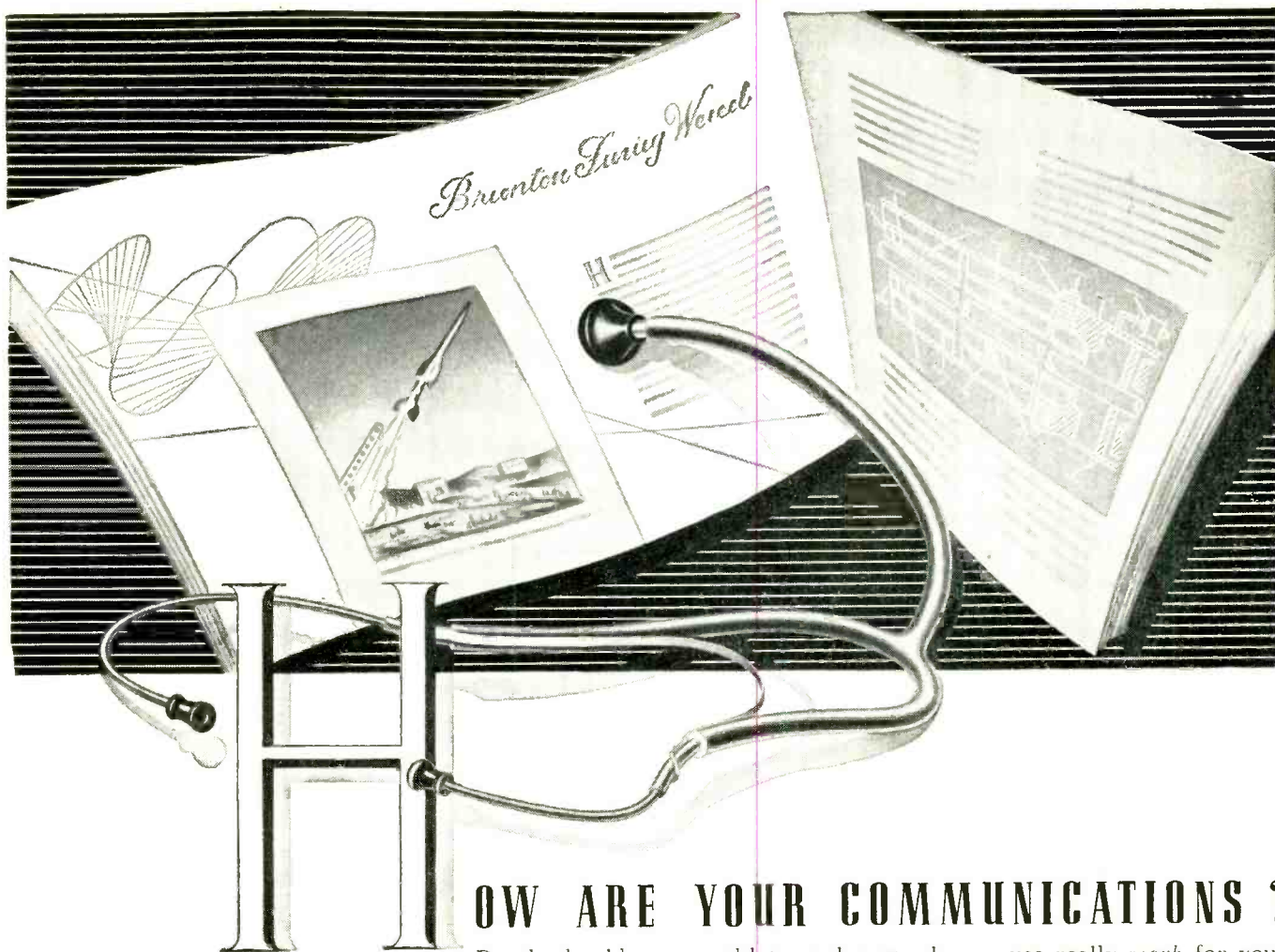

HOW ARE YOUR COMMUNICATIONS ?

Do the booklets, pamphlets, and manuals you use really *work* for you? Are these vital publications, that tell the story of your products and your company, as effective, readable, well designed and illustrated as they can be? Today more than ever, your entire operation is judged by each annual report, employee manual, and public relations piece that you produce. Have you examined your communications lately? If you have any doubt as to the impact of your instructional and promotional literature, remember . . .

COMMUNICATION IS OUR BUSINESS

For a good many decades McGraw-Hill has stood for complete coverage in the business literature field. Now the McGraw-Hill TECHNICAL WRITING SERVICE offers a new approach to your publication problems — an *integrated* writing, editing, illustrating, and printing service for the *custom* production of: INSTRUCTION MANUALS, PRODUCT BULLETINS, TRAINING AIDS, INDUSTRIAL RELATIONS LITERATURE, ANNUAL REPORTS, COMPANY HISTORIES, PROCEDURAL GUIDES and other collateral literature. More than 150 editorial and graphic experts are at your disposal, ready to prepare high-quality material to your own or government specifications. Save time, save money . . . and make your communications work! Let *our* staff be your staff for technical and business publications.

McGraw-Hill Book Co. TECHNICAL WRITING SERVICE

Write or phone Technical Writing Service, McGraw-Hill Book Co., Inc.
330 West 42nd Street, New York 36, N. Y. • LONgacre 4-3000

This service is available through ad agencies.



IT'S POWRARM RIGHT DOWN THE LINE

... At Power Products Co., Grafton, Wis.

Wilton PowRarms, placed every two feet on a 100' long conveyor, help Power Products Corporation assemble six gasoline engine models on a single line. PowRarms, which can be moved to any angle in all three planes, and locked in position, enable operators to adjust work pieces to any convenient angle of approach. The result is an exceptionally high rate of production on all models. PowRarms come in a wide range of automatic and manual models.

Attach this ad to your letterhead for a free demonstration or literature!

WILTON TOOL MFG. CO., INC.

SCHILLER PARK, ILLINOIS

Sold by Leading Distributors The World Over

ELECTRONIC ENGINEERS

Consider Your future
with the Aeronautical Division
of ROBERTSHAW-FULTON

... in Design and Development of Aircraft and Missile Control Systems and Communications Equipment.

We have immediate requirements for graduate Electrical or Electronic Engineers with 2 to 5 years experience in Servo Techniques, Transistor and/or Mag Amp Circuitry or similar projects.

With this rapidly expanding Aeronautical Division the future is bright. Send today for your copy of our brochure which details our facilities, and your opportunity with us.

Wire or Write today to:

LAWRENCE R. BIGBEE
Dir. of Engineering Placement
407 N. Manchester, Anaheim, California



Aeronautical Division
Robertshaw-Fulton
CONTROLS COMPANY

retain the conventional pronunciation of the Roman letters so that it is much easier for the untrained foreigner to read. Thus the word SHEEM-BAH-SHEE is spelled Shimbashi in Hepburn instead of Simbasi as in Kunrei.

Either denpa or dempa is an acceptable Romanization because it is customary to change an "N" to an "M" if it precedes a "P" or a "B". In either case, the word is pronounced DEM-PAH. The gizitsu, however, is an error in any Romanization. It should be GIJUTSU in the Hepburn system. (Note: "G" is always pronounced as in the English word "GO": never as in "GEM".)

Most foreigners, especially Americans, would tend to pronounce this word gijutsu as gee-JOO-tsoo, putting an incorrect accentuation on the middle syllable. The Japanese pronounce it something like geej'ts' almost failing to voice the u's. For this reason, it would be pronounced almost exactly alike whether it were gijitsu or gijutsu. Thus when writing the word in Roman letters it is easy to confuse the two. This is especially true because of the fact that very little of the language is ever so transliterated. It is generally written in the Kanji (ideograms) and the two syllabaries Hiragana and Katakana. Anyone who wants to learn the written language must learn fifty Hiragana symbols, fifty Katakana symbols and approximately two thousand Kanji ideographs.

Since the war, the close ties between Japan and the United States have caused a considerable number of American words to become accepted into the Japanese language. But due to the limitations of the Japanese syllabary, some ordinary English words take on rather strange sounds and spelling: "miruku" is as close as they can come to the word "milk"; butter is "bata"; a word like television comes out terebijon, although it is usually shortened to terebi. Tape-recorder would have to be written te-pu rikoda, and that would probably be shortened to your word teriko.

As for ordinary words and older words such as your superregeneration, they are arrived at thusly: The

•CONTACTS•

FOR THE FIELD OF
ELECTRONICS

Lightning Calculator

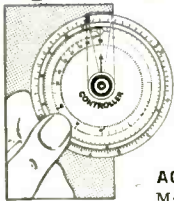

Germany's latest simplifies all calculations, multiplication of discounts, percentages and profits

JUST TURN THE DISC AND READ THE ABSOLUTELY ACCURATE RESULTS

Made of fine aluminum just three inches in diameter, it does the work of a ten-inch slide rule, fits in a vest pocket. Complete with easy to follow instruction booklet. In Plastic Case \$6.95 Prepaid. 10-day Money-Back Guarantee.

PROGRESSIVE ENTERPRISES, INC.
135 W. 20th St., N.Y. 11, N. Y., Dept. TT3

THIS "CONTACTS" SECTION IS AVAILABLE TO MANUFACTURERS THAT WANT TO ADVERTISE IN "ELECTRONICS" USING SPACE UNITS SMALLER THAN THE MINIMUM RUN OF BOOK DISPLAY SPACE.

FOR INFORMATION
PLEASE WRITE:

"CONTACTS SECTION"

ELECTRONICS

330 WEST 42 STREET
NEW YORK 36, N. Y.

PROFESSIONAL SERVICES

Consulting—Patents—Design—Development—Measurement

in

Radio, Audio, Industrial Electronic Appliances

BRIGGS ASSOCIATES, INC.

Engineering Services

ELECTRONICS **MECHANICAL**
Development — Manufacturing — Consulting
Special Machines — Instrumentation — Automation
Electron Tube Design, Materials, Reliability

10 DeKalb St. Broadway 9-2120 Norristown, Pa.

Measurements Corporation

Research & Manufacturing Engineers

HARRY W. HOUCK MARTIAL A. HONNELL

Specialists in the Design and
Development of Electronic Test Instruments
Boonton, New Jersey

CROSBY LABORATORIES, INC.

Murray G. Crosby & Staff

Radio - Electronics
Research Development & Manufacturing
Communication, FM & TV

Robbins Lane, Hicksville, N. Y.
WE11s 1-3191

NIAGARA ELECTRON LABORATORIES

CONSULTATION - DESIGN - CONSTRUCTION
MFG. THE THERMOCAL RELAY

Specializing in solution of problems of electronic and electro-physical instrumentation for the research or analytical laboratory. Industrial plant problems also invited.

Andover, New York Cable Address: NITRONLAB

DELAWARE PRODUCTS CO.

Analog Voltage to Digital Conversion
Digital Voltage Recording Systems

Design-Development-Manufacturing

300 Broadway Camden 3, N. J.

PICARD & BURNS, INC.

Consulting Electronic Engineers

Analysis and Evaluation
of Radio Systems

Research Development and Production
of Special Electronic Equipment

210 Highland Ave. Needham 94, Mass.

ELECTRONIC RESEARCH ASSOCIATES, INC.

"TRANSISTORIZE" YOUR PRODUCT!
Complete Service in consulting, research, development, and production on Transistor circuitry, products and instrumentation.

67 East Centre Street Nutley, N. J.
NUTley 2-5410

ERCO RADIO LABORATORIES, INC.

Radio Communications Equipment

Engineering - Design - Development - Production
Our 27th Year in Air to Ground
Communications and Radio Beacons

Garden City • Long Island • New York

ALBERT PREISMAN

Consulting Engineer

Television, Pulse Techniques, Video
Amplifiers, Patent technical consultation.

616 St. Andrews Lane, Silver Spring, Maryland.
JU1111er 5-6307

TELECHROME MFG. CORP.

Electronic Design Specialists

COLOR TELEVISION EQUIPMENT
Flying Spot Scanners, Color Synthesizers, Keyers,
Monitors, Oscilloscopes and Related Apparatus,
Telemetering for Guided Missiles.

J. R. Popkin-Curman Pres. & Dir. of Eng.
28 Ranick Dr. Amityville, L. I., N. Y.

General Atronics Corporation

David E. Sunstein George J. Lauren
Dr. Robert W. Hoop Bernard D. Steinberg
Consulting Services—Electronics, Acoustics, Technical
Planning Operations Research for Industrial
Consumer and Government Products.
125 City Line Av. Bala-Cynwyd, Pa. (Phila. suburb)
MOhawk 4-8090

TRANSISTOR CONSULTANTS, INC.

TRANSISTOR ENGINEERING

Consultant: cos: analysis; training programs.
Engineering systems and Design Studies.
Instrumentation; Prototype Construction.
New Processes and Component Designs for Transistorized Computers; Servos; Radios.
Laboratory Investigations; "Life-Test"; "Fringe Area" Evaluations.

P. O. Box 333 Morris Plains, N. J.

THE KULJIAN CORPORATION

ELECTRONICS DIVISION

Consulting Electronic Engineers

Research Development, Production of
Automatic Controls — Special Instrumentation
1200 No. Broad St., Philadelphia 21, Pa.
Stevenson 2-9000

WHEELER LABORATORIES, INC.

Radio and Electronics

Consulting — Research — Development

R-F Circuits — Lines — Antennas

Microwave Components — Test Equipment

Harold A. Wheeler and Engineering Staff
Great Neck, N. Y. HU11ter 2-7878

McCann Engineering Company

Consulting Mechanical Engineers

Design and Development of Test Equipment
for Synchros, Potentiometers, Gyros, Etc.
Redesign of Products—Trouble Shooting
Production—Automatic Machinery
Special Machines with Sequence, Form
Recognition, Dimension Decision and
Special Environment Features.

9210 So. Vermont Los Angeles 34, Calif.

YARDNEY LABORATORIES

Research-Design-Development

Electro-Chemical Generators of Energy

40-48 Leonard Street WOrth 6-3100
New York 13, N. Y.



MANUFACTURERS' REPRESENTATIVES

IN THE ELECTRONIC INDUSTRY

As a service to readers, **ELECTRONICS** presents the advertisements for some of the leading manufacturers' representatives in the electronic industry. These firms are qualified to help the *Manufacturer* with his distribution problems; the *Buyer* with his product needs.



W. A. BROWN & ASSOCIATES, INC.

3610 Mt. Vernon Ave., Alexandria, Virginia
Huntsville, Alabama
Baltimore, Maryland
P. O. Box 286, Indian River City, Florida

Our 8th Year! - AGGRESSIVE COVERAGE

COMPLETE FACILITIES

DEMO VAN — DEMO TRAILER

STATION WAGON — COMPANY CARS

MAILING SERVICE —

COMPETENT FIELD ENGINEERS & OFFICE PERSONNEL

SERVING THE SOUTHEAST WITH ELECTRONIC AND ELECTRO-MECHANICAL EQUIPMENT

FRED F. BARTLETT & CO. Electronic Instrumentation

PA.(E) • N.J.(S) • DEL. • MD. • D.C. • VA.
160 Morlyn Ave., Bryn Mawr, Pa.
LAwrence 5-7030

MANUFACTURERS' REPRESENTATIVES!

Plan to use the "Manufacturers' Representatives" Section of the ensuing 1957 Mid-June Electronics Buyers' Guide to sell your products; attract new lines. For information, write:

Classified Adv. Division
Post Office Box 12
New York 36, N. Y.

How do you sell to the electronic market?

Engineers specify products on the drawing board. When design is approved, and mass production goes into full speed, the specified products are, in most instances, bought in quantity. Therefore, to get mass sales in the electronic industry, advertise in the magazine that is read by working engineers

ELECTRONICS of course!

A McGraw-Hill Publication, 330 West 42nd St., N. Y. 36, N. Y.

Kanji symbol for SAI means "twice" or "again"; the symbol for SEI means "to live" or "to be born". Thus the combination of the two symbols, SAISEI, means to regenerate. The symbol for CHO means "to surpass" or "super". All three symbols in combination, CHOSAI-SEI, have the rather obvious meaning of superregenerate.

The Japanese language is quite interesting in itself, but the country of Japan is sheer fascination.

FRANK LESAGE
RCA Field Engineer
APO, San Francisco, Cal.

On Transistor Symbols

DEAR SIRS:

JUST noted Mr. James E. Pugh's letter, page 436, Sept. 1956, in regard to a proposed new symbol for junction transistors. Would like to add my two cents worth to any contemplated change from present usage.

While I, for one, am in favor of progress and agree wholeheartedly that some change in transistor symbology may be needed eventually, I can't help but feel that Mr. Pugh's suggestion is a bit premature.

In the case of vacuum tubes, the symbols are all basically the same, with but minor modification to indicate the type. A triode and tetrode, for example, differ by only the addition of a grid symbol.

However, what Mr. Pugh suggests is a radical change in symbology, change which would, at one stroke, obsolete the great mass of existing literature.

His primary reason for change appears to be to differentiate between point-contact and junction transistors. This would leave the field using an almost obsolete symbol, for the point-contact transistor is, like "old soldiers," fading away. Relatively few transistor manufacturers include point-contact types in their lines.

More important, perhaps, are the many new types of semiconductor devices rapidly coming up . . . the drift or field-effect transistor, GE's Unijunction or double-based diode transistor, Marvelco's

tandem transistor, IBM's thyatron transistor (a combination of a junction and a point-contact unit), various types of surface barrier transistors, including Philco's new sbdt type, and, of course, thyratrons, phototransistors and many special purpose types.

If Mr. Pugh's suggestion were followed to the letter, we would need a different symbol for every type of transistor . . . with the field in such a fluid state we could easily end up with more transistor symbols than all other component symbols combined.

Personally, I would suggest a waiting period, at least until the field is less fluid, in the meantime retaining the present, and widely used, symbol. But we could think about a symbology that would permit adding new types (as easily as we can add a new vacuum tube type, by adding a grid or plate line). Later, when basic transistor types, at least, have crystallized, a general meeting of representatives of all interested groups . . . standards groups, the military, the IRE and AIEE, and other recognized authorities, could consider a more formal standardization of symbology.

LOUIS E. GARNER, JR.
*Technical Consultant
Silver Spring, Md.*

Self-Sustained Emission

DEAR SIRs:

IN the January 1, 1957 issue, under *Electrons At Work* some results of studies on self-sustained emission from cold cathodes were described (p 190).

While secondary emission formerly was the means of starting the self-sustained emission, it is not a factor in the operation. Field emission and avalanche effects in the coating are believed to be the essential mechanism.

The work was initiated in the Signal Corps Engineering Laboratories and is now being continued under a Signal Corps Contract.

A. M. SKELLETT
*Director of Research
Tungsol Electric Inc.
Bloomfield, N. J.*



MANUFACTURERS' REPRESENTATIVES

IN THE ELECTRONIC INDUSTRY

As a service to readers, ELECTRONICS presents the advertisements for some of the leading manufacturers' representatives in the electronic industry. These firms are qualified to help the *Manufacturer* with his distribution problems; the *Buyer* with his product needs.

SERVING:

NEW JERSEY
EASTERN PA.
DELAWARE
MARYLAND
WASHINGTON, D. C.
NORTH CAROLINA
VIRGINIA
SOUTH CAROLINA

||
since 1938

J.A. MAGUIRE
AND COMPANY

Representing

The William Brand & Co., Inc.
Davis & Hemphill
Forbes & Wagner Co., Inc.
Foster Transformer Co.
Mandex Mfg. Co., Inc.
The Metal Etching Co.
R. C. L. Mfg. Co.

116 N. 7th St.
Camden 2, N. J.
Phone: WOODLAWN 6-3118

29 Alleghany Ave.
TOWSON 4, MD.
VALLEY 5-3836

SAMUEL K. (Mac) MACDONALD
NOBLE C. (Noble) SHILT • JOHN J. (Jack) MAHONEY
JOHN J. (Jack) D'ANGELO • JOHN E. (John) LARKIN, JR.
JAMES P. (Jim) FARIES • ERNEST J. STEFKOVIC • "BEANIE"

SAMUEL K. MACDONALD, Inc.
MANUFACTURERS' REPRESENTATIVES

1531 Spruce St., Philadelphia 2, Pa. Other Offices: Pittsburgh
Baltimore • Washington, D. C.

Territory:
PENNSYLVANIA
NEW JERSEY
DELAWARE
MARYLAND
VIRGINIA
WEST VIRGINIA
DISTRICT OF COLUMBIA

HORMAN ASSOCIATES, INC.
2017 "S" STREET, N.W.
WASHINGTON 9, D. C.
DECATUR 2-5705

SERVING
DELAWARE, MARYLAND,
DISTRICT OF COLUMBIA,
ARLINGTON AND FAIRFAX
COUNTIES IN VIRGINIA
TELETYPE NO. WA-559

REPRESENTING —

HEWETT-PACKARD CO.
SORENSEN & COMPANY INC.
VARIAN ASSOCIATES
BETA ELECTRIC CORP.
ELECTRO-MEASUREMENTS INC.
GERTSCH PRODUCTS INC.

SENSITIVE RESEARCH INST. CORP.
SANBORN COMPANY
KINTEL (formerly KAY LAB)
JOHN FLUKE MANUFACTURING CO.
BUDD STANLEY COMPANY, INC.
WEINSCHEL ENGINEERING CO.

Complete Recalibration Laboratory

ENGINEERING and

From the Chart...

DETAILS DESCRIBING SOME OF THE PROFESSIONALLY SIGNIFICANT POSITIONS

<p>SENIOR COMPONENT APPLICATION SPECIALIST</p> <p>Salary to \$12,000</p> <p>This position requires an Electrical Engineering Degree with at least six years' electronic design experience. This experience should include the application of components, such as: transformers, relays, resistors, capacitors, semiconductors and rotary equipment. You must have the ability to counsel and guide young engineers lacking broad technical experience. The position is located in pleasant suburban Moorestown, New Jersey, adjacent to Philadelphia.</p>	<p>OPERATIONS ANALYST</p> <p>Salary to \$12,000</p> <p>Join an operations research group in evaluating the air defense mission. Areas of effort include: search and development problems; probability studies to determine missile and aircraft weapons systems effectiveness using Monte Carlo differential gain theory and other techniques; evaluation of ground control systems, kinematic studies using a high speed digital computer.</p> <p>Advanced degree or equivalent in math, physics or engineering. Minimum 3 to 5 years' experience. Position at Airborne Systems Laboratory, Waltham, Mass.</p>	<p>TRANSDUCER DEVELOPMENT ENGINEER</p> <p>Salary to \$12,500</p> <p>Interesting position for Acoustical Engineer to work with small group in design and development of devices and systems. Prominent in the microphone and transducer field, RCA has interesting work in the following areas: headsets, and loudspeakers, noise and vibration measurement and analysis, speech compression systems, noise cancellation microphones, psychoacoustics. RCA has facilities ideal for the man who desires advanced work. Position is located in Greater Philadelphia area at Camden, New Jersey.</p>
<p>INFRARED SYSTEMS ENGINEER</p> <p>Salary to \$15,000</p> <p>Engage in overall coordination and design of infrared systems for Airborne Fire Control Defense and Missile Guidance. You should be experienced in general performance specifications, servo design, displays, Infrared heads and optical systems. You also must be capable of giving technical guidance to Junior Engineers. Minimum of 5 years' experience necessary. EE or Physics degree. The location is Camden, New Jersey, in the Greater Philadelphia area.</p>	<p>EQUIPMENT DEVELOPMENT ENGINEER—MECHANICAL</p> <p>Salary to \$11,500</p> <p>Opportunity for work of advanced development nature in areas of receiving tubes and semiconductors. Conception, design and development of prototype equipments. Education, background and experience in mechanization, and related fields required. Knowledge of electromechanical systems desirable. Air-conditioned area, with complete shop and laboratory facilities. Position at Harrison, N.J. . . . 30 minutes from N.Y.C.</p>	<p>MANAGER MICROWAVE TUBE ENGINEERING</p> <p>Salary—Open</p> <p>Supervise fifteen engineers and technicians investigating application problems and development of new applications for Microwave tubes. Work with equipment customers and field personnel on Microwave tube applications. Preparation of new technical data and specifications. Supervision of laboratory test sections in performance of life, design, and environmental tests. Located at Harrison, N.J. . . . 30 minutes from N.Y.C.</p>
<p>COMMUNICATION DEVELOPMENT ENGINEER</p> <p>Salary to \$12,500</p> <p>An ideal opportunity for a development engineer. Work in Advanced Development Information Handling and Control Group. Develop techniques for application to PCM for voice and data transmission. Work will involve development of both digital and analog transistor circuits for application to pulse code modulation voice and data transmission systems. One to two years' experience in digital and/or communication techniques is required. EE or Physics degree. Location in Camden, New Jersey, in Greater Philadelphia area.</p>	<p>ELECTRONICS TEST ENGINEER—MICROWAVE</p> <p>Salary to \$11,000</p> <p>Interesting opening for a top quality, creative man to design and develop electronic test equipment for evaluation of magnetrons and traveling-wave tubes. Microwave and pulse circuit background required. Work will be in development of measurement techniques and adaptation to developments and production tube testing. The right man will find exceptional opportunities for advancement. Located at Harrison, N.J., just 30 minutes from mid-town Manhattan.</p>	<p>TRANSMITTER DESIGN SUPERVISOR</p> <p>Salary to \$14,000</p> <p>This position requires a BSEE and eight to ten years' experience in High Power UHF or VHF television transmitter design. You should be capable of supervising a small group of design engineers and providing technical and administrative direction for the group. If you possess this experience and are looking for an opportunity to advance, you are invited to visit RCA, in suburban Moorestown, New Jersey.</p>

Modern benefit program . . . relocation expenses paid . . .

SCIENCE at



STARTING SALARIES: NON-MANAGERIAL TO \$15,000 ... MANAGERIAL OPEN

FIELDS OF ENGINEERING ACTIVITY		MANAGERS	TYPE OF DEGREE AND YEARS OF EXPERIENCE PREFERRED											
			Electrical Engineers			Mechanical Engineers			Physical Science			Ceramics Glass Technology Metallurgy		
			0-2	2-3	4-15	0-2	2-3	4-15	1-2	2-3	4-15	1-2	2-3	4-15
• SYSTEMS <i>(Integration of theory, equipments and environment to create and optimize major electronic concepts.)</i>	AVIATION ELECTRONICS • CONTROLS		W	W	W	W	W	W	W	W	W			
	DIGITAL DATA HANDLING DEVICES	M		M	M		C	C		C	C			
	MISSILE WEAPONS SYSTEMS • RADAR	M	W	W	W	W	W	W	W	W	W			
	INERTIAL NAVIGATION			W	W		W	W		W	W			
	COMMUNICATIONS		C	C	C	C	C					C	N	
• DESIGN • DEVELOPMENT MISSILE WEAPONS SYSTEMS —Planning and Design—Radar—Fire Control—Servomechanisms—Computers		C	W	W	W	W	W	W	W	W	W			
		M	C	M	X	M	M	X	M	M	X			
AVIATION ELECTRONICS —Radar—Computers—Servomechanisms—Shock and Vibration—Circuitry—Remote Control—Heat Transfer—Sub-Miniaturization—Automatic Flight—Automation—Transistorization—Infrared—Airborne TV		W	W	W	W	W	W	W	W	W	W			
RADAR —Circuitry—Antenna Design—Servo Systems—Gear Trains—Intricate Mechanisms—Fire Control—Information Handling—Displays		M	W	W	W	W	W	W	W	W	W			
COMPUTERS —Systems—Advanced Development—Circuitry—Assembly Design—Mechanisms—Programming—Digital Data Handling Devices		M	C	C	C	C	C	C	C	C	C			
KINESCOPIES (B & W and Color), OSCILLOSCOPES —Electron Optics—Instrumental Analysis—Solid States (Phosphors, High Temperature Phenomena, Photosensitive Materials and Glass to Metal Sealing)			L	L	L	L	L	L	L	L	L	L	L	L
RECEIVING TUBES —Tube Design—Test and Application Engineering—Chemical and Physical Development—Methods and Process Engineering—Advanced Development			H	H	H		H	H		H	H	H	H	
SEMICONDUCTORS —Transistors—Semiconductor Devices—Materials			V	V	V	V	V	V	V	V	V	V	V	V
MICROWAVE TUBES —Tube Development and Manufacture (Traveling Wave—Backward Wave—Magnetron)		H	H	H	H		H	H		H	H	H	H	
GAS, POWER AND PHOTO TUBES —Photosensitive Devices—Ceramic to Metal Sealing—UHF and VHF—Super Power			L	L	L	L	L	L	L	L	L	L	L	
COMMUNICATIONS —Specialized Systems—Microwave—Mobile—Aviation—Audio—Propagation Studies—Acoustics—Transducers			C	C	C		C	C		C	C	C	C	C
BROADCAST AND TV —Monochrome and Color Studio Equipment—Camera—Monitors—High Power Transmitters			C	C	C	C	C	C	C	C	C			
• SYSTEMS APPLICATION <i>(Evaluation and Planning—Design and Development—Modification—Specification)</i>	MISSILE TEST INSTRUMENTATION (Data Acquisition and Processing)—Radar—Telemetry—Timing—Communications—Optics—Computers	F	F	F	F	F	F	F	F	F	F	F	F	F
	RADAR —Airborne—Surface—Shipboard—Sonar—Fire Control	F	F	F	F	F	F	F	F	F	F	F	F	
	COMMUNICATIONS —Radio—HF—VHF—UHF—Microwave—Telephone—Teletype—Telegraph Terminal Equipment—Wave Propagation	F	F	F	F	F	F	F	F	F	F	F	F	
	• MACHINE DESIGN —Mechanical and Electrical—Automatic or Semi-Automatic Machines		L	L	L	L	L	L		L	L			

Locations: C—Camden, N. J. F—Cocoa Beach, Fla. H—Harrison, N. J. L—Lancaster, Pa. M—Moorestown, N. J. N—New York, N. Y. S—RCA Service Co. (Cherry Hill, N. J.); Alexandria, Va.; Tucson, Ariz.; Dayton, Ohio; San Francisco, Calif. V—Somerville, N. J. W—Waltham, Mass. X—West Los Angeles, Calif. Y—Marion, Ind. Z—White Sands, N.M.

Please send resume of education and experience, with location preferred, to:

Mr. John R. Weld, Employment Manager
 Dept. A-16C, Radio Corporation of America
 30 Rockefeller Plaza, New York 20, N.Y.



RADIO CORPORATION of AMERICA

Copyright 1957 Radio Corporation of America

RAYTHEON

Electronics?

**Raytheon is one of the world's largest companies
the largest in New England!**

History-making events, such as the first interception of an aircraft by a guided missile,—the mass production of magnetron tubes for radar early in World War II which broke the bottleneck in shipment of radars to the U.S. Fleet,—the mass production of subminiature tubes that made possible the famous proximity fuses,—the installation of the radar network for the arctic DEW line,—the nation-wide use of Raytheon radar by the C.A.A. for airways traffic control,—development of tactical, lightweight, portable television relay (KTR),—equipping the U.S. Air Force B-52 with a bombing radar of unerring accuracy—all these are but guide posts to indicate the versatility and engineering achievements that keep Raytheon in the forefront of the electronic industry.

Raytheon Systems Laboratories in New England



Bedford Laboratory, Bedford, Mass.

this Division's work has resulted in developmental contracts for future generations of guided missiles. In a period of ten years it has grown from a small laboratory to an organization of over thirty-four hundred employees, including more than five hundred engineers.

If you are interested in investigating the many opportunities for scientists and engineers at any of these facilities write: G. P. O'Neil, Raytheon Manufacturing Company, Missile Systems Division, Bedford, Massachusetts.



Maynard Laboratory, Maynard, Mass.

to all healthy youngsters, this new engineering organization is growing fast and presents unmatched opportunities for engineers who want challenging, interesting work with the prospect of real progress.

Staffing activities are currently under way at all levels. If you are interested in these or similar projects, contact us to discuss details.

Write John J. Oliver, Raytheon Manufacturing Company, Maynard Laboratory, P. O. Box 87, Maynard, Mass.

Representatives of each Laboratory will be in New York during the I.R.E. Show. They'll be glad to talk about Raytheon and YOU.

Raytheon is the only electronic company with prime contracts in both air-to-air and ground-to-air missiles—Sparrow III for the Navy, Hawk I for the Army. Over-all responsibility for the development and production of these systems rests with Raytheon's Missile Systems Division, which besides the engineering Laboratory at Bedford, Massachusetts, has production plants in Lowell and Andover (Shawsheen), Massachusetts and in Bristol, Tennessee, supplemented by flight test facilities at Oxnard, California and White Sands, New Mexico. The success of

The recently formed Maynard Laboratory is engaged in the design and development of unique & advanced coherent Radar Systems used in the fields of navigation, fire control, guidance & countermeasures. Specializing primarily in the navigation and guidance of supersonic aircraft but embracing specific applications of countermeasures equipment and shipborne radar, the laboratory has a nucleus of some of the country's finest engineers & scientists working on the application of Electronics to the needs of our rapidly expanding Aircraft Industry. As is common

New England?

devoted exclusively to Electronics and



Wayland Laboratory, Wayland, Mass.

Raytheon's new Wayland Lab has over 5 acres of enclosed working area with a "completeness" of facilities that is difficult to match. This Lab has four independent creative departments:

RADAR—pulse radar equipment including

1. Ground based surface and air search.
2. Airborne navigational, search, tracking, and fire control.
3. Long range search, gap-filler, acquisition, and fire control.
4. Air traffic control, weather, and commercial marine.

COMMUNICATIONS—scatter, radio relay, and T.V. terminal and message circuit multiplex equipment.

SONAR—submarine, ship, and airborne sonar equipment.

COUNTERMEASURES—radar countermeasures equipment and advanced countermeasures systems and techniques study.

If you're interested in learning more about the work being done at Wayland, please write Donald B. Stillman, Staff Assistant to Manager, Wayland Laboratory, Wayland, Mass.

Raytheon is a unique organization. It has found through experience that the greatest progress is made by decentralization. This is the reason it is made up of several "Operations" each with its "Divisions" which have prime responsibility for the success of their specific tasks. This encourages initiative and promotes individual growth. An engineer works with the minimum of supervision but can confer with men of national reputation. Raytheon is a growing company with young ideas and young executives many of whom have engineering background and experience.

Raytheon's Systems Laboratories are located in suburban areas where easy commuting, good living in uncrowded urban or country communities, is the rule. There is easy access to the cultural, medical, educational and research advantages

of Boston as well as to the recreational opportunities of New England's mountains, lakes and seashore.

Starting salaries are excellent. Recognition both professionally and financially is dependent on ability and performance. Adequate supporting technical personnel is provided and the fringe benefits are liberal. You can take advanced courses at Harvard, M.I.T., Boston University, Northeastern — and Raytheon pays the major costs! You may attend meetings and seminars at company expense.

Our contract commitments are growing as a result of increased demand for our services — we need additional scientists and engineers interested and experienced in the work we are doing to GROW with us. We welcome the opportunity of arranging an interview to tell you more. Contact us soon!

If you are interested in any other of Raytheon's Operations, contact L.B. Landall, Professional Personnel Section, Raytheon Manufacturing Company, Waltham 54, Mass.



Excellence in Electronics

99.07%

ENGINEERS AND DESIGNERS

STAY WITH

AC

**THE ELECTRONICS DIVISION
GENERAL MOTORS**

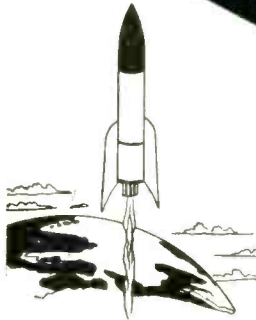

Pioneering Opportunities in the Following Fields!

- Missile Guidance
- Avionics
- Automotive-Aviation Electronic Products
- Computers
- Jet Engine Fuel Controls

AC turn-over figures are amazing. Less than 1%! Speaks highly for the advancement opportunities, working conditions and wages we pay our Engineers and Designers. It's been that way for years at AC. That's why we are so proud of and why you should investigate your Better Future at AC by writing

G. M.'s long-standing policy of decentralization creates unlimited opportunities for qualified Electrical, Mechanical Engineers and Designers. Masters Degree Program available at University of Wisconsin, Milwaukee to all eligible AC Engineers. Arrange a personal confidential interview in your locality by writing

For Employment Application
Mr. Cecil E. Sundeen, Supervisor of Technical Employment

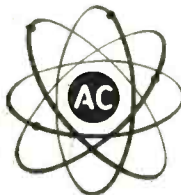

**AC the ELECTRONICS DIVISION
GENERAL MOTORS CORPORATION**

Flint 2, Michigan

Milwaukee 2, Wisconsin

ELECTRONIC ENGINEERS

RESEARCH DEVELOPMENT

Expansion of our engineering department requires electronic engineers with radar, servo, sonar or transistor circuit experience. Excellent opportunity for advancement with top-calibre associates. New modern plant in the suburbs with ideal laboratory facilities and well-trained technical assistants.

Other Opportunities in the following areas:

- **TECHNICAL WRITERS**
- **DRAFTING** Electrical Layout
- **DETAILING** Electrical-Mechanical

DESIGN ENGINEERS

Must have EE degree or equivalent, with 3-5 years experience in one of the following:

- Flight Simulators
- Analog Computers
- Radar & Sonar Trainers
- Radar Guidance & Fire Control Systems
- Redesign, Modification & Testing of Radar & Electronic Systems
- Electronic Installation & Maintenance
- Coil & Transformer Design
- Packaged Power Supplies

Other Openings For:

COMMUNICATIONS EQUIPMENT DESIGNERS

COMPUTER DESIGNERS

FIELD ENGINEERS

(*)Must have E.E. degree or equivalent with 5-10 yrs. experience.

*Positions located throughout USA

LOCATION:

On U. S. Highway 22, thirty miles (45 minutes) from New York City.

ENVIRONMENT:

One of the finest plants of its kind . . . spacious, modern, air-conditioned. Conducive to bringing out the best of your abilities!

ABOUT THE COMPANY:

Organized in 1945. Engaged in research, design and development for the Armed Services

ITS BENEFITS:

- Pension Plan
- Group Life Insurance
- Paid Holidays
- Paid Sick Leave
- Paid Vacations
- Education & Tuition Assistance
- Other Group Insurances

DURING I.R.E. CONVENTION

Interviews in NYC, March 18-21

For Personal Interview
contact our representative:

Columbus 5-0060

Mayflower Hotel, 15 Central Park West
(Bet. 61-62 Sts, N.Y.C.)

Or Send Resume to:

STAVID Engineering, Inc.

U.S. Highway 22,
Plainfield, N. J.
Watchung, P.O.
Plainfield 7-1600

Rapid Advancement
for
TUBE ENGINEERS

Design and Produce
MAGNETRONS
and Other
**ADVANCED TUBE
TYPES**

New
facilities in
**WILLIAMSPORT
PA.**

Have you been given the opportunity to keep abreast of latest developments in magnetrons — the new backward wave magnetron, especially? Are you being allowed to use your full capabilities in the design and production of advanced tube types?

If you feel your experience and ability merit greater recognition... if you feel you ought to be rewarded financially and professionally for the contributions you know you can make... it's time you got in touch with us. It's time, in fact, you joined us at Sylvania, where new facilities provide a ground-floor opportunity for rapid advancement.

Moreover, we can offer you several unique advantages. For example:

THE POSITION

First of all, you'll work on magnetrons for military and commercial use as well as advanced tube types for all purposes. As a product engineer on a particular tube type (or several) you will have complete responsibility, from original

development to production in quantity. It's an opportunity to use all your engineering talents — to see your ideas through from start to finish.

THE FACILITIES

A new plant at Williamsport, Pa.—just opened, and offering ground-floor opportunities in advanced electronics.

A new wing at Woburn, Mass.—to be added soon to the already-extensive facilities of this division.

These are only two examples of expansion at Sylvania in the field of electronics. As we continue to branch out in new directions—we offer more and more opportunities for talented engineers to join a dynamic, forward-looking company, and acknowledged leader in a growing young industry.

You'll find salaries at Sylvania are competitive with the best in the industry. And our benefits plan takes into consideration not just your present needs, but your future requirements as well.

Please write directly—in strictest confidence—to: **ROLAND W. COATES**

ELECTRONICS DIVISION

SYLVANIA

SYLVANIA ELECTRIC PRODUCTS INC.
100 Sylvan Road Woburn, Mass.

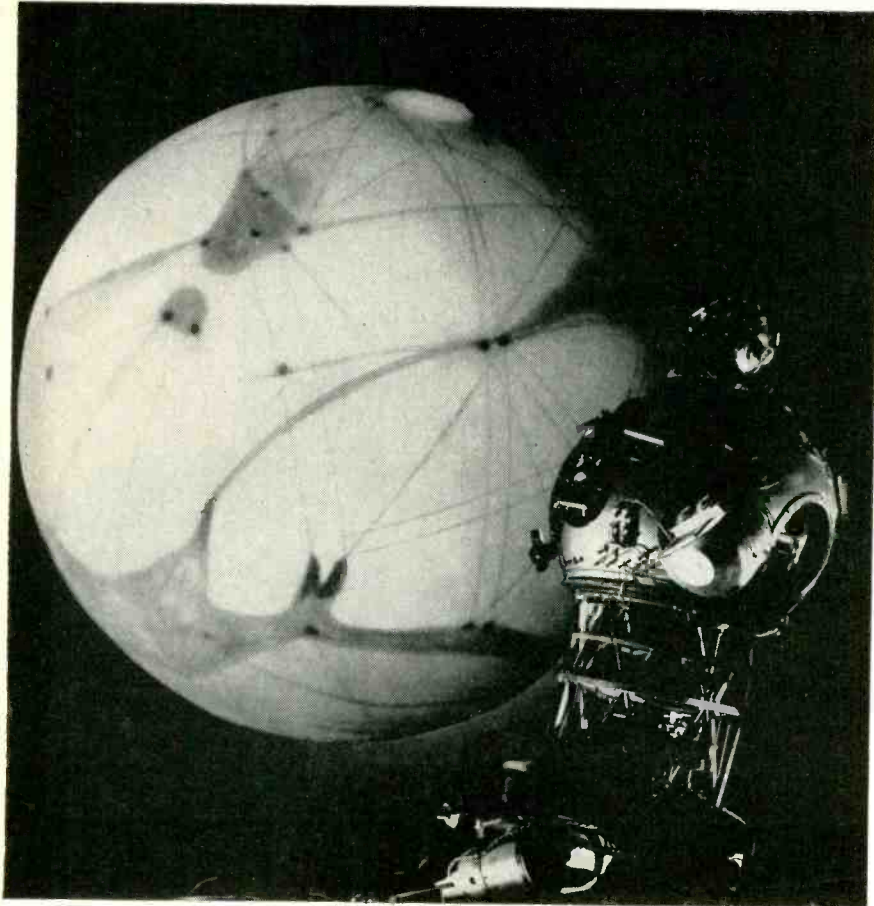

**THE
BIG
PICTURE
IN
ELECTRONICS**

A rocket to the moon within 10 years—to Mars in 25! This is the prediction of experts in the new field of astronautics.

Right or wrong, *we* can tell you this: Within months, the first man-made earth satellite will be Martin-launched, and we're already "running some numbers" on the first moon vehicle.

The direction is up—and out—and Martin is pioneering the way. To the electronics engineer with vision, this means Ceiling Infinity.

There are some challenging opportunities available. Contact J. J. Holley, Dept. E-3, The Glenn L. Martin Company, Baltimore 3, Maryland.



MARTIN
BALTIMORE

ENGINEERS

ELECTRICAL ELECTRONIC

PHYSICISTS

Excellent opportunities are available to work on interesting and non-routine research and development programs. These positions will be particularly attractive to imaginative and versatile individuals with broad interests.

TUCSON, ARIZONA
AND

CHICAGO OPENINGS

These are permanent positions with a progressive, independent research organization offering competitive salaries, optimum professional associations and liberal benefits which include tuition free graduate study and generous relocation allowance.

If You Have Experience In:

**RADAR AND RADIO
ANTENNAS AND PROPAGATION
INSTRUMENTATION
CONTROL SYSTEMS
MICROWAVES
COMMUNICATION SYSTEMS
ELECTRONIC COMPONENTS
COMPUTER DEVELOPMENT**

WRITE:

A. J. Paneral
ARMOUR RESEARCH FOUNDATION
of Illinois Institute of Technology
10 West 35th St.
Chicago 16, Illinois

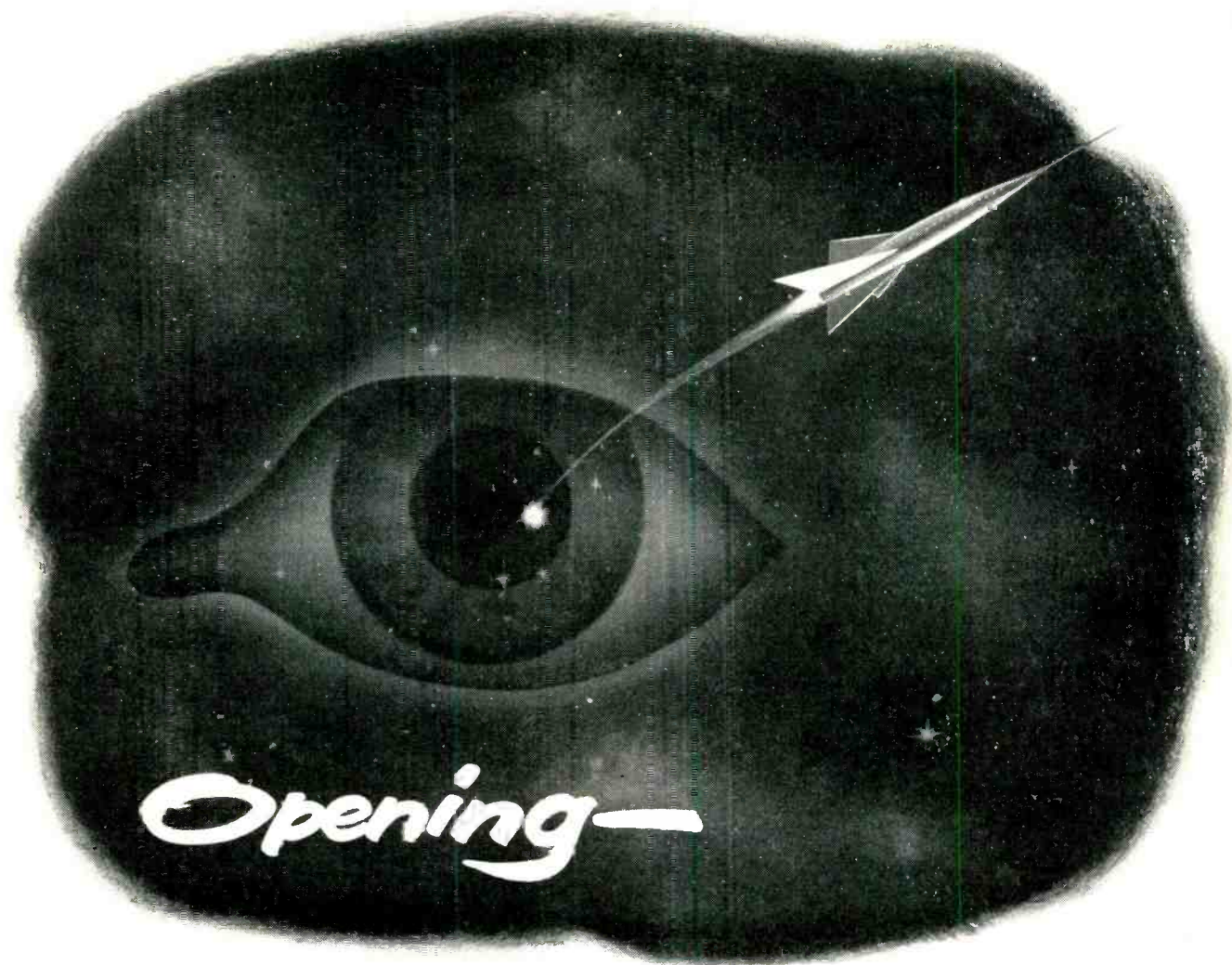

for minds with 20-20 vision

THE ABILITY to see clearly with the mind's eye is characteristic of most good engineers. Nowhere is it more highly prized than here at Goodyear Aircraft.

Our creative engineers are men of talent and training, of course. But beyond that, they are men gifted with an uncanny capacity to look ahead, think ahead and above all, see ahead.

Their materials are the progress of the past. Their genius is the promise of the future.

To fulfill that promise, our engineers have at their disposal the most modern facilities, including one of the largest computer laboratories in the world. They have unlimited opportunities in the field of their choice — whether it be airships, missiles, electronic guidance equipment, structures — or countless other challenging activities.

There are no limits, either, on individual thought, no barrier to the flow of inspiration.

If you have faith in your ideas and confidence in your ability to make them work, a rewarding career can be

yours at Goodyear Aircraft. Our continued growth and diversification have required expansion of our engineering staffs in all specialties at both Akron, Ohio, and Litchfield Park, Arizona.

You'll find salaries and benefits agreeable. If you wish to continue your academic studies, company-paid tuition courses leading to advanced degrees are available at nearby colleges.

For further information on your career opportunities at Goodyear Aircraft, write: Mr. C. G. Jones, Personnel Dept., Goodyear Aircraft Corporation, Akron 15, Ohio.

They're doing big things at
GOOD YEAR
AIRCRAFT

The Team To Team With in Aeronautics

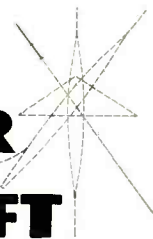

engineers . . . physicists
NEW opportunities at
MOTOROLA in Phoenix
 Arizona

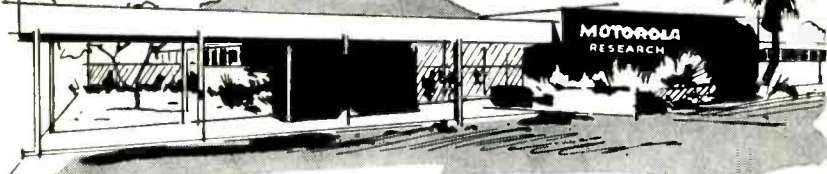

WORK IN A VACATIONLAND
 (your family will love year-round outdoor living)
WHILE YOU ADVANCE YOUR CAREER

Here are two of the country's newest and most complete Electronic Laboratories; (1) our expanding Military Research lab. and (2) our new Semi-Conductor Division. Both offer outstanding career advantages . . . (see listing below). This is your opportunity to get in on the ground floor of a swiftly expanding company. You'll enjoy working in air conditioned comfort in the most modern and well instrumented laboratories . . . with liberal employee benefits, including an attractive profit sharing plan and association with men of the highest technical competence.

Salary levels are open and commensurate with ability. You'll like working with Motorola in Phoenix, where there's room to grow and it's fun to live.



MOTOROLA IN PHOENIX HAS OPENINGS FOR:

Electronic Engineers, Mechanical Engineers, Physicists, Metallurgists, and Chemists, in the following categories:

Research Laboratory
 Microwave Antennas
 Pulse and Video Circuitry
 Radar Systems Design
 Circuit Design
 Electro-Mechanical Devices
 Systems Test
 Transistor Applications

Semi-Conductor Division
 Transistor Application
 Transistor Devices
 Solid State Physics
 Physical Chemistry
 Metallurgical Engineering
 Production Engineering
 Transistor Sales Engineering
 Electrical Design and Layout



DRAFTSMEN

for above positions write to:

Mr. R. Coulter, Dept. A
 3102 N. 56th St.,
 Phoenix, Ariz.

for above positions write to:

Mr. V. Sorenson, Dept. A
 5005 E. McDowell Rd.,
 Phoenix, Ariz.

Excellent opportunities in RIVERSIDE & CHICAGO, too

RIVERSIDE, CALIF., Exceptional openings in Military Operation Analysis, Analog Computer Flight Simulation, Digital Computer Analysis, Microwave Systems, Servo Mechanisms, Missile Systems, Aerophysics.

Write to:

Mr. C. Koziol, Dept. A
 P O Box 2072
 Riverside, California

CHICAGO, ILL., Challenging positions in Two-Way Communications, Microwave, Radar and Military Equipment, Television (Color), Radio Engineering, Field Engineering, and Sales Engineering.

Write to:

Mr. L. B. Wrenn, Dept. A
 4501 Augusta Blvd.
 Chicago 51, Ill.



MOTOROLA

ELECTRONIC ENGINEERS!

HERE'S THE OPPORTUNITY OF YOUR LIFETIME!

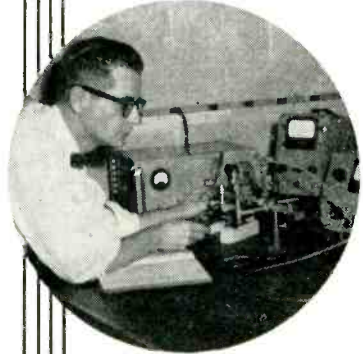

For Just Three Cents!



That's right! The stamp on your letter asking for more information about MEMCO opens the door of opportunity . . .

- to use your creative engineering talents.
- to work on all phases of your projects.
- to be appreciated as an engineer, not as a replaceable cog in a big machine.
- to get top pay and many benefits.
- to build a sound, worthwhile future.

So, if you are tied up in red tape . . . if the scope of your work is limited . . . if you can't use your creative engineering talents . . . then MEMCO offers you a welcome escape from stagnation and monotony.

For full details please write to:

Mr. J. E. Richardson,
 Personnel Director

MARYLAND ELECTRONIC

MANUFACTURING CORPORATION
 5009 Calvert Road
 College Park, Maryland
 (A suburb of Washington, D. C.)

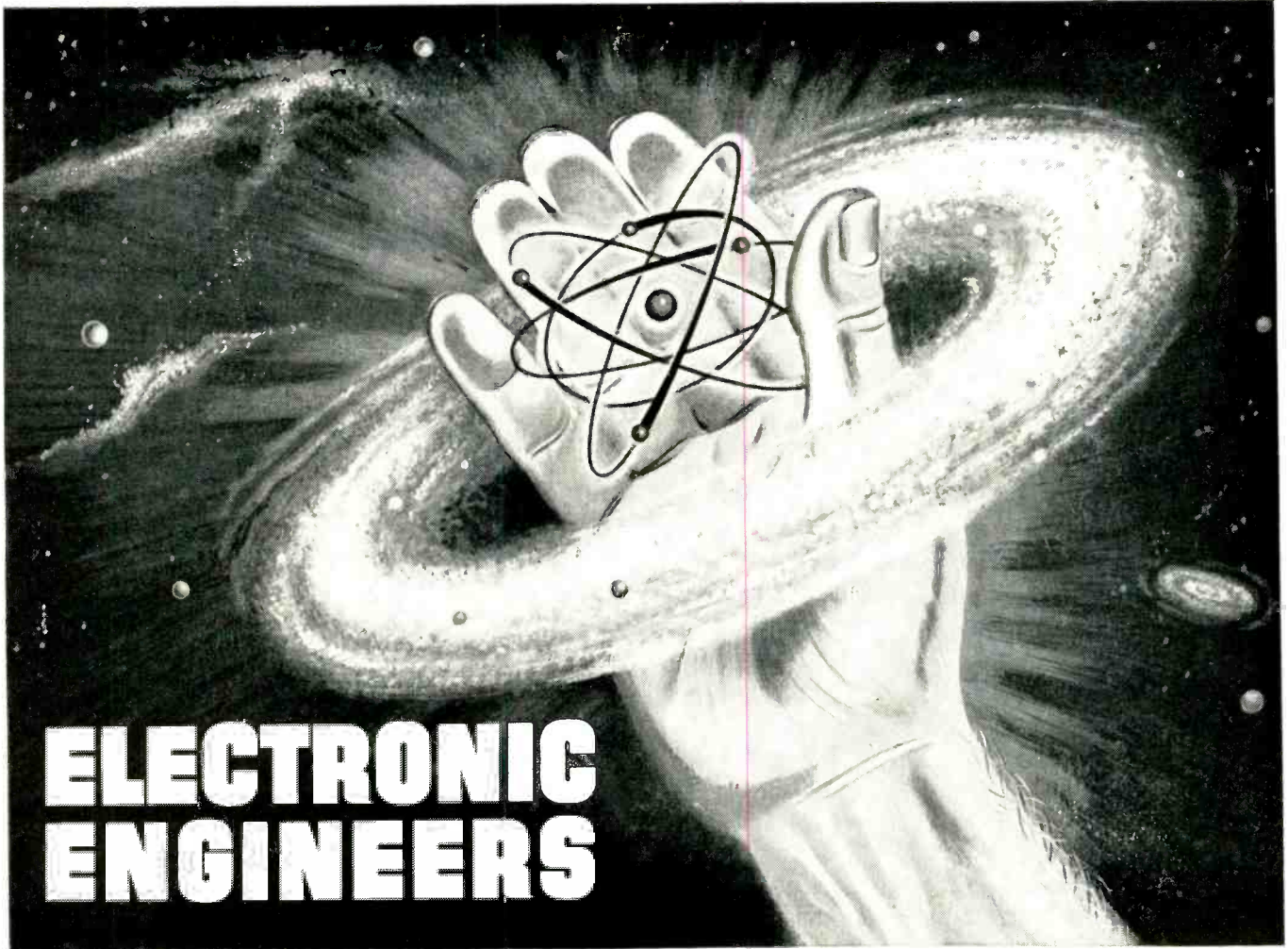

ELECTRONIC ENGINEERS

True professional accomplishment within your grasp!

Everything and everyone at Bendix Radio is attuned to the task of producing significant accomplishments in the field of advanced electronics. We have the vision of leading, creative engineers. We have the skilled sub-professional people who are resolute in their dedication to the job of producing the BEST. We have the most modern facilities and equipment to encourage an engineer's finest efforts. We have company policies which recognize to the fullest extent the professional aspects of the engineer's career. At Bendix Radio, engineers are kept well-informed as to the status of company work and project developments.

As a Bendix Radio engineer, you will receive an excellent salary, periodic merit reviews and complete company benefits — including assistance in graduate education. You will live the good life with many cultural and recreational advantages in a beautiful suburban area amidst friendly people.

We invite you to set your goals high and to move upward toward their accomplishment *fast* at Bendix Radio. Act now!

Simply drop us a postal card briefly stating your education and experience. We'll act fast . . . and confidentially!

THERE ARE OPENINGS WITH BENDIX RADIO TO WORK IN THESE FIELDS:

- MISSILE GUIDANCE & TRACKING SYSTEMS
- RADAR WARNING SYSTEMS
- MILITARY ELECTRONICS RESEARCH & DEVELOPMENT
- AUTOMOTIVE ELECTRONIC RESEARCH
- AIRBORNE ELECTRONICS SYSTEMS
- MOBILE COMMUNICATIONS SYSTEMS

ADDRESS: Employment Supervisor, Dept. J-1



Bendix

DIVISION OF BENDIX AVIATION CORP., BALTIMORE 4, MD.

Radio

Career opportunities

in BOSTON

are better

than ever!



Long range research, engineering and production programs at Honeywell in Boston have created new and unusual career opportunities in the instrument and semiconductor fields. In addition to professional and financial advancement, these career opportunities offer the *recognition* that goes with working in a small compact engineering group of an autonomous division and *advancement* through association with the world's largest producers of automatic controls.

GYRO AND ACCELEROMETER DESIGN ENGINEERS

Design and develop new and improved gyros and/or accelerometers or related products. Theoretical and practical background desired.

DATA HANDLING AMPLIFIER DESIGN ENGINEERS

Electronic circuit design of data handling amplifiers, demodulators, power supplies and other related products in audio range.

ELECTRICAL DESIGN ENGINEERS FOR AUTOMATION EQUIPMENT

Develop contactless control devices, logic network, switching circuits and other related products. Theoretical and practical background desired.

NEW PRODUCT DEVELOPMENT AND PROCESS ENGINEERS

Electrical, Electronic, Mechanical and Chemical Engineers responsible for the device development or for the development of the manufacturing processes involved in the production of semiconductor devices.

CIRCUIT DESIGN AND APPLICATION ENGINEERS

Develop circuitry techniques to use semiconductor devices for their characteristics of amplification, switching, or control.

SCIENTISTS

Metallurgists, Chemists, and Physicists experienced in the application of solid state physics and associated sciences as applied to the research and development of semiconductor devices.

Write Mr. F. L. Mannix, Personnel Director, Minneapolis-Honeywell, Boston Division, 1400 Soldiers Field Road, Boston 35, Mass., or call ALgonquin 4-5202

MINNEAPOLIS
Honeywell



B O S T O N D I V I S I O N

Admiral.

has specific openings
for experienced
engineers in:

**Television
Military and
and
Civilian**

UHF RECEIVER DESIGN

With experience in low noise wide band front ends and I F circuits for military television systems.

TUNER ENGINEER

To design tuners for UHF and VHF systems—military and civilian. To pursue a program of original ideas in this field at the developmental level.

DEFLECTION CIRCUITRY

With experience in designing horizontal and vertical oscillators, control circuits and associated components.

EXPORT TELEVISION

TV receiver engineer for work on a line of export receivers. Familiarity with tuners and I.F. systems for European standards and conditions useful in this work. Will consider a non-citizen with practical TV experience.

MILITARY TV

Airborne and ground systems including receivers, transmitters, cameras, antennas, sync generating systems, and displays, as well as printed circuit and transistor applications.

Career-minded men with several years specialized experience are invited to join our rapidly expanding programs in communications projects.

Current openings offer excellent income and employee benefits including retirement plan, paid group insurance and college tuition refund plan plus ideal working conditions.

If you are an engineer with qualifications in any of these fields explore your opportunity with Admiral today. Write Mr. Walter Wecker, Personnel Manager.

Admiral Corporation

3800 W. Cortland Street
Chicago 47, Illinois

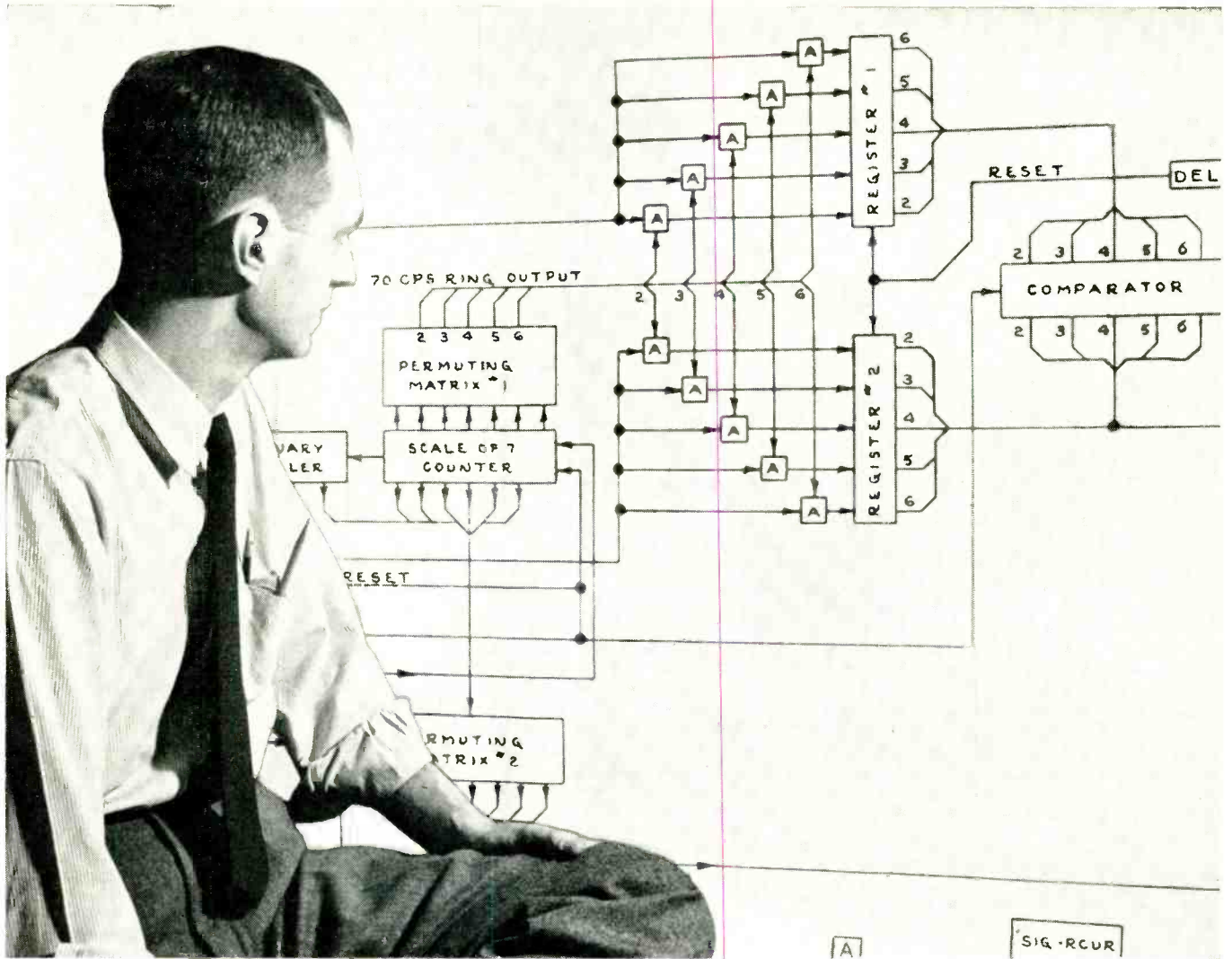

ELECTRONICS ENGINEERS...

How well can you realize this in circuit form?

Our engineers are faced with this kind of challenge every day—how to translate block diagrams into circuits *efficiently*—in order to create electronic “hardware” for today’s military and civilian needs.

If you thrive on challenges . . . if you can translate ideas into circuits—you’ll find a rewarding lifetime career in the Electronics Division of Stromberg-Carlson. Rewarding in terms of advancement, recognition, and salary.

Our company is one of the fastest growing in the country. The Electronics Division is in the midst of a three-fold expansion. We’re in the process of moving into a fine new building with plenty of elbow room and magnificent facilities.

You’ll find no greater growth potential anywhere. And you’ll enjoy living in this beautiful, progressive upstate New York community, with its abundant facilities for recreation, education, and culture.

**SEE YOU AT
THE I. R. E. SHOW!**

Check the list of assignments, decide where you’ll fit best, and send your letter or resume now to

R. W. HOLMES, Electronics Engineering

- Communication Systems
- Components and Specifications
- Countermeasures
- Data Systems
- Digital Techniques
- Field Engineering
- Microwave Circuits
- Missile Guidance Systems
- Navigational Systems
- Radar
- Sales Engineering
- Systems Test Equipment
- Transistor Engineering
- Writers—Technical

SC STROMBERG-CARLSON COMPANY **GD**
 A DIVISION OF GENERAL DYNAMICS CORPORATION
 29 Carlson Road, Rochester 3, N.Y.

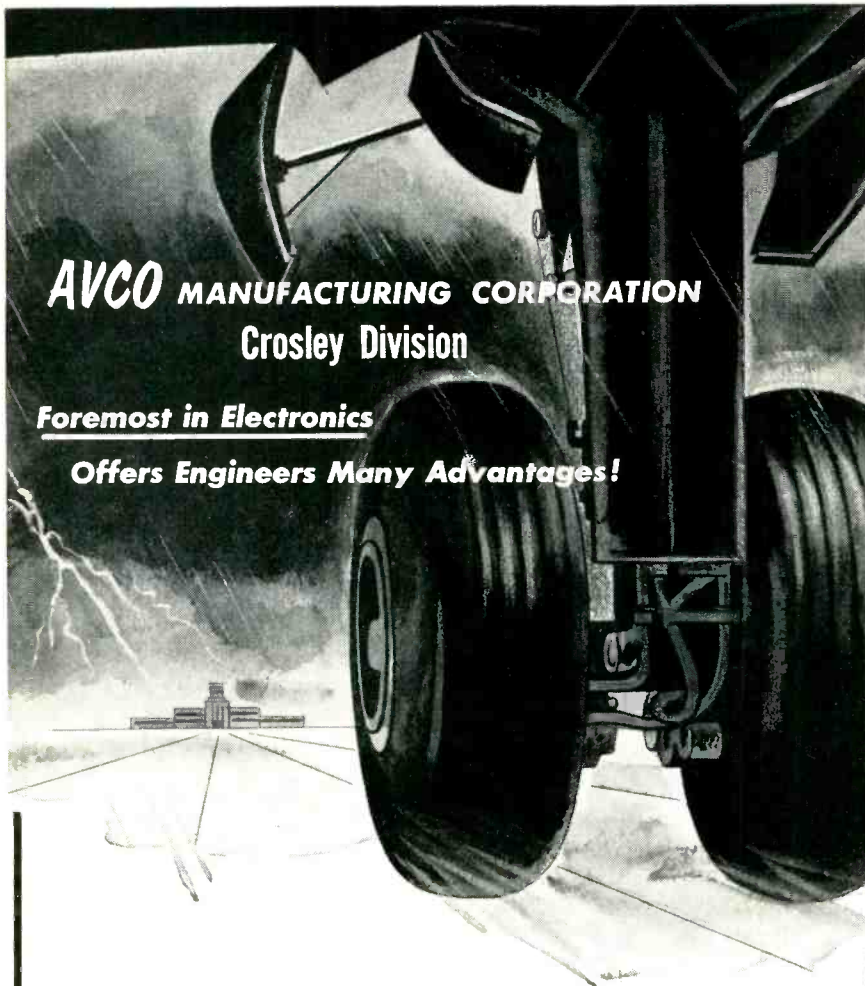

AVCO MANUFACTURING CORPORATION
Crosley Division

Foremost in Electronics

Offers Engineers Many Advantages!

WHEN THE PILOT CAN'T SEE
"Volscan" BRINGS

Him Down . . . SAFELY! SURELY!

One of the major advances in aviation history is "Volscan". This remarkable electronic device enables the pilot to come in even though he can't see where he is or where he is going. Wouldn't you like to play a part in important achievements such as this? If so, we have top openings for engineers in many different categories.

- | | |
|--|--|
| <ol style="list-style-type: none"> 1. Guided Missiles 2. Computer and Analytical Services
<small>(Design and Development)
(Programming and Application)</small> 3. Ground Radar 4. Air Traffic Control 5. Antennas & Micro-Wave Equipment | <ol style="list-style-type: none"> 6. Communications
<small>(Airborne Transmitters and Receivers)</small> 7. Airborne Fire Control 8. Airborne Defense Systems 9. Servo Mechanisms 10. Transistorized Equipment |
|--|--|

Contact us and find out where you can fit into the major programs now being started. There are numerous company benefits and you will be paid generous relocation expenses.

SEND A RESUME TO:

Mr. Nick M. Pagan,
 Employment Manager,
 Dept. L
AVCO Manufacturing Corp.
Crosley Division
 2630 Glendale-Milford Road
 Evendale, Cincinnati 15, Ohio

ENGINEERS

PARTS APPLICATION

(Reliability)

ME or EE degree with design experience and/or application experience. Job will be to recommend types of parts to be used and how these parts shall be used.

Qualified men will become a vital part of a Reliability Group.

GM

INERTIAL GUIDANCE SYSTEM PROGRAM

• ELECTRONICS DIV.,

**Milwaukee 2, Wis.
 Flint 2, Mich.**

Enjoy Challenging Opportunities in the most versatile Laboratories in the country. Work with the top men in the field and with the finest test, research and development facilities. We are in the process of a Major, Permanent, Expansion Program. New Plant facilities being added in suburban Milwaukee area.

To aid you in your professional advancement AC will provide financial assistance toward your Master's degree. A Graduate Program is available evenings at the University of Wisconsin, Milwaukee.

GM's Electronics Division aggressive position in the field of manufacture and GM's long-standing policy of decentralization creates individual opportunity and recognition for each Engineer hired.

**Recent EE,ME
 Graduate Inquiries
 Also Invited**

Milwaukee offers ideal family living in a progressive neighborly community in cool, southern Wisconsin where swimming, boating, big league baseball and every shopping and cultural advantage is yours for the taking.

To arrange personal, confidential interview in your locality send full facts about yourself today to

Mr. Cecil E. Sundeen
 Supervisor of Technical Employment

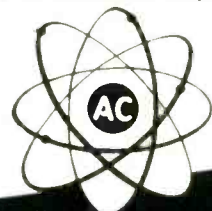

**Electronics Div.
 General Motors Corp.**
 FLINT 2, MICHIGAN
 MILWAUKEE 2, WISCONSIN

MAKING THE BIG DECISION?

BRIGHT FUTURE

MONOTONY

NO FUTURE

NEW HORIZONS

OLD SALT MINE

INTERESTING WORK



FIELD ENGINEERING WITH A FUTURE - AT RAYTHEON

Wondering about your next step? Raytheon field engineering gives you a real chance to up-grade your future. Many Raytheon executives are former field engineers.

Interesting, stimulating work with our Design and Engineering Departments evaluating and testing the latest equipment gives you valuable experience. Assignment to one of these missile, sonar, counter-measures, bombing or fire control radar programs prepares you for a key field position.

Primarily, we're interested in men with an E.E. degree and field experience, but you get full consideration when you have radar, sonar, missile or similar background. Men with mechanical and hydraulic experience also are needed.

Your Raytheon future includes an attractive salary; assistance in relocating; insurance; educational programs, etc. Interviews in most U.S. cities, Japan, some European countries. Write E. K. Doherr for full details.

Excellence in Electronics



RAYTHEON MANUFACTURING COMPANY
Government Service Department
100 River Street, Waltham 54, Massachusetts

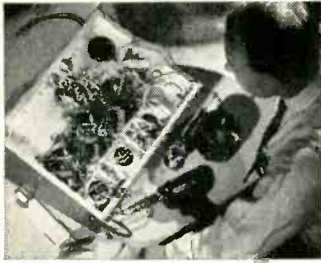

TEST EQUIPMENT

The Test Equipment Engineer is engaged primarily in the design of specialized missile check-out equipment. As missiles push the state of the art, test equipment must exceed the missiles in precision and reliability. Automatic programming, go-no-go evaluation, and automatic data processing add up to automation in missile testing.

This engineer is evaluating his design of a precision power supply—one of the building blocks that will be system engineered into a family of versatile matched missile and sub-system test equipment. Engineers work as individuals.

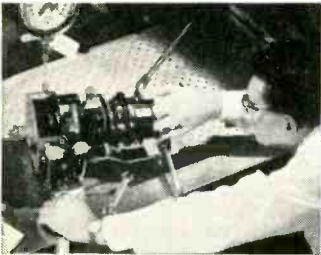

HYDRAULIC DESIGN

Excellent opportunities are available for the engineer to observe the performance of his design. Here, under the watchful eyes of its designer, a hydraulic power unit is undergoing adjustment and setting prior to severe testing at simulated high altitude conditions.

Many components, which a few months ago seemed almost impossible to design, are now being tested under the severe conditions required to qualify them for flight operation—and passing with flying colors.



STEERING INTELLIGENCE

Two Steering Intelligence Engineers discuss space allotment in a new guidance component. This close association of engineers with the "flying" equipment is typical of the Steering Intelligence Section. Engineers in this section are primarily and directly concerned with refining the guidance equipment to steer the missile with greater accuracy, at greater ranges and with simpler and more reliable electronic equipment and, consistently, with minimizing the cost. Work is actively in progress in every principal field from microwave equipment to inertial end instruments.



**PRIME CONTRACTOR
FOR TALOS MISSILE**



**Offers more interesting
and challenging
job opportunities!**

If you are interested in guided missiles, you will be especially interested in Bendix. As prime contractor for the important and successful Talos Missile, the job opportunities here cover the widest possible scope, and the opportunities for advancement are practically unlimited.

Here is a compact, hard-hitting organization backed by all the resources of the nation-wide Bendix Aviation Corporation—an organization dedicated to the design and production of the finest in guided missiles.

If you can accept a challenge, want an opportunity to grow with a leader in its field, and can accept the responsibility that goes with opportunity, send for the thirty-six-page book "Your Future in Guided Missiles". It gives the complete, detailed story of the function of the various engineering groups and the many job opportunities available for you.

Just fill out the coupon. It may help you plan a successful future in the guided missile field.

Bendix Products Division—Missiles
402 L, Bendix Drive, South Bend, Indiana

Gentlemen: I would like more information concerning opportunities in guided missiles. Please send me the booklet "Your Future In Guided Missiles".

NAME _____

ADDRESS _____

CITY _____ STATE _____



P
H
O
E
N
I
X

At the crossroads of opportunity for men with vision in Electronic Engineering and other related fields:

**GOODYEAR
AIRCRAFT
CORPORATION**

ELECTRONIC LABORATORY

Arizona Division
Litchfield Park, Arizona

A Subsidiary of the
GOODYEAR TIRE & RUBBER CO

We have openings in our modern Laboratories at all levels of experience in the branches of Engineering listed below. We urge you to investigate the opportunities here for employment. We think you will like the friendly, informal atmosphere of our laboratory. The stimulation of working with top level engineers and scientists will make your work interesting and challenging.

**Complete Missile and Electronic Systems
Microwaves, Servomechanisms
Radars and Stabilized Antennas
Transistor Application, Electronic Packaging
Electronic Ground Support Equipment**

Long range research and development projects

University of Arizona graduate studies available under the Goodyear Fellowship Program, or company financed evening courses.

*Leisure Living At Its Best
"In the Valley of the Sun"*

Modern Inexpensive Housing

Send resume to: A. E. Manning

Engineering and Scientific Personnel

GOODYEAR AIRCRAFT

**LITCHFIELD PARK
PHOENIX, ARIZONA**

Similar opportunities available in our Akron, Ohio Laboratory

ENGINEERS . . .



• *Market Development*



• *Visit Customer Plants*



• *Plant Engineer Contacts*

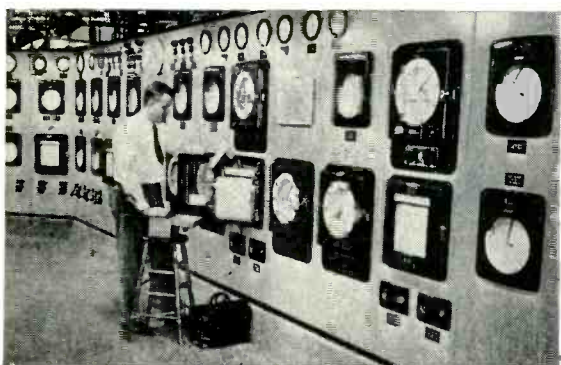

• *Servicing Customers' Instruments*



Step into the Expanding Field of Instrumentation

Ever Think of MARKETING As a Career?

Marketing, as we practice it, consists largely of analyzing problems and finding the answers. It is far removed from "ringing doorbells", because the doors are already open. And it is far removed from "pushing" anything or anybody, because buying and selling in industry are based on reason, not emotion. Industrial Marketing includes careful engineering, good judgment, and expert knowledge of the equipment you're discussing.

For our open positions in Marketing a college degree in science or engineering is necessary plus a normal liking for people and an ability to get along with them. Our specifications are as follows:

MARKET DEVELOPMENT: 3-5 years experience in the following areas of specialization. Instrumentation and control knowledge desirable: Aluminum or Steel, Glass or Cement, Electric power, Combustion Control, Nucleonics, Electrical Measurements, Data Processing, Petroleum or Chemical Process Instrumentation. Location—Philadelphia

SALES ENGINEERING: 1-3 years experience in selling instrumentation and controls to basic process industries. Location—District Sales offices listed below

SERVICE ENGINEERING: 2-5 years experience in Steam or Electric Power plant instrumentation. Location—Chicago, Philadelphia, Houston, Cincinnati, Atlanta

This can be a career of infinite variety, great usefulness and excellent income. Why not let us set up an interview with some of the managers of our Marketing Departments.

We also have several openings for experienced technical personnel in Research, Development and Engineering.

Address your reply to:

Wayne L. Besselman, Coordinator of Technical Employment



4979 Stenton Ave., Philadelphia 44, Pa.

- | | | | |
|------------|--------------|---------------|--------------------------------|
| Atlanta | Columbus | Los Angeles | Seattle |
| Boston | Denver | Milwaukee | St. Louis |
| Buffalo | Detroit | New York | Tulsa |
| Chicago | Hartford | Philadelphia | Integra, Leeds & Northrup, Eng |
| Cincinnati | Houston | Pittsburgh | |
| Cleveland | Indianapolis | San Francisco | |

BURROUGHS RESEARCH CENTER NEEDS *Good* ENGINEERS

That Special Something
... ONLY CERTAIN MEN HAVE IT

The men who possess that 'special something' come in all shapes and sizes and with all colors of hair (and even without it, too). There's no strikingly distinctive physical appearance that labels a man an engineer or scientist but, rather, it's an intangible quality and attitude that is quickly evident in every GOOD research engineer.

It's not only his intensity and purposeful intelligence that contribute to this unusual quality; it's also his rare ability to assume responsibility and thoughtfully analyze, deduct, rearrange and solve the many facets of complex problems that make him what he is — a creative man. His skill at peering into the unknown and wrestling sense from chaos sets him apart from most men . . . and it is largely on him that a great deal of the world's future rests.

Engineers of this caliber seeking unusual avenues of research can find satisfying and stimulating careers at the Burroughs Research Center where men with that 'special something' are ALREADY solving tomorrow's problems today.

Inquiries invited from those qualified as

- ELECTRICAL ENGINEERS
- ELECTROMECHANICAL ENGINEERS
- PHYSICISTS • MATHEMATICIANS
- MECHANICAL DESIGN ENGINEERS
- MECHANICAL ENGINEERS

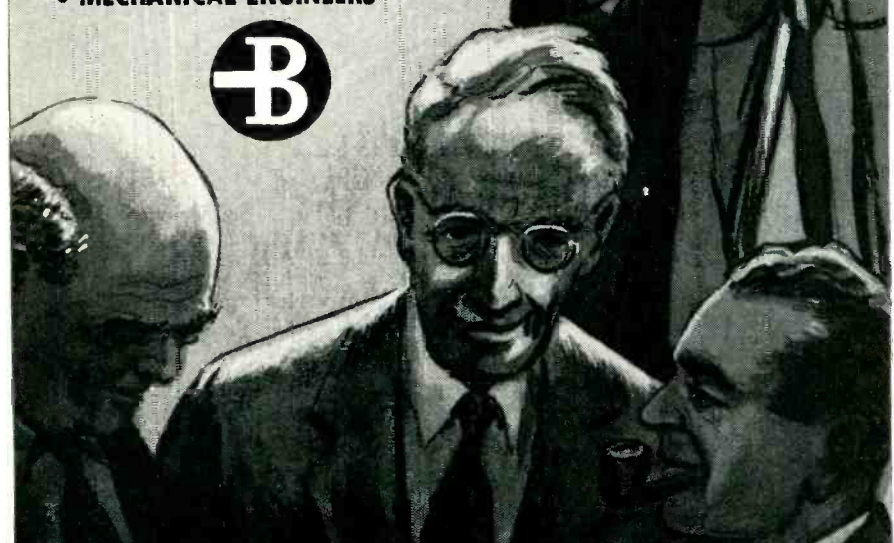

Write or Telephone

M. E. JENKINS, PLACEMENT MANAGER • PAOLI 4700

For Interview at Your Convenience

BURROUGHS CORPORATION
Research Center

PAOLI, PA. • On Philadelphia's Main Line Near Historic Valley Forge

**ENGINEERS
 AND
 SCIENTISTS**

with degrees in
 E.E., M.E., Ch.E. or PHYSICS

Honeywell
 BROWN INSTRUMENTS

First in Controls

**LEADS THE WAY IN
 A WORLD OF
 OPPORTUNITIES**

■ **THE COMPANY**—Judging a company on its past performance constitutes sound logical thinking. Looking over BROWN INSTRUMENTS record of accomplishment tells a reassuring story of continuous growth during nearly a century of pioneering in the industrial instruments and control field.

■ **ASSIGNMENTS**—Diversified . . . permanent, non-routine, in the newest scientific field of NUCLEAR INSTRUMENTATION and AUTOMATION. The bulk of our work is for industrial use.

■ **COMPENSATION**—Rewarding . . . salaries are competitive with those offered in other industries. Our benefits include free group health insurance, hospitalization and surgical benefits, as well as an excellent retirement plan. Relocation assistance.

■ **GROWTH**—Unlimited . . . your performance and salary is re-evaluated twice yearly. Our policy to promote from within is responsible for present management.

■ **EDUCATION**—Excellent . . . financial assistance for those desirous of furthering their education at one of several renowned Philadelphia colleges or universities.

Men with the vision to create and the will to act can find an abundant outlet for their creative talent in either RESEARCH, DESIGN and DEVELOPMENT APPLICATION or SYSTEMS ENGINEERING. Whatever the choice, you and only you will be able to control and measure your progress with this company which leads the way in a world of opportunities . . .

Write to D. R. GARVEY
Manager Employment,
Dept. E

Honeywell

BROWN INSTRUMENTS DIV.

Wayne & Windrim Aves.
 Philadelphia 44, Pa.

ENGINEERS · SCIENTISTS
PROJECT ENGINEERS
ENGINEERING SPECIALISTS

Mountain View, California

MICROWAVE PHYSICS LABORATORY

- Magnetic Ferrites
- Gaseous Electronics
- Paramagnetic Resonance
- Ferroelectrics
- Microwave Propagation
- Guided Microwave Control Devices

ELECTRONIC DEFENSE LABORATORY

- Systems Analysis & Design
- Operations Research
- Computers
- Equipment Development
- Microwave Circuits & Antenna Design
- Mechanical Design

For positions in either of these two laboratories at Mountain View, Calif. please send resume to J. C. Richards, Box 205 Mountain View, Calif.

MICROWAVE TUBE LABORATORY

For research, development and production on Traveling Wave Tubes, Backward Wave Oscillators and Klystrons

- Internal Microwave Tube Circuits
- Power Handling Circuits
- Interaction Studies on Beams & Fields
- Boundary Conditions Studies in Cavities
- Ceramic-Metal Techniques
- Production Devices Design
- Field Generation Devices

For positions at this laboratory at Mountain View, Calif. please send your resume to Gordon McClure 500 Evelyn Ave. Mountain View, Calif.

Sylvania
Laboratories
now
selecting men
for
advanced
electronic research
& development

CHOOSE EAST COAST OR

WEST COAST LOCATION

East or West, Sylvania Laboratories are in the forefront of advanced electronics research and development, offering fine positions to men capable of important scientific contributions...and interested in the rewards this growing company offers for creative work. Positions are open in the following fields.

During the IRE Show in New York, March 18 thru 21, you are invited to meet with our Technical Representatives at the Waldorf Astoria Hotel.

Waltham, Massachusetts

MISSILE SYSTEMS LABORATORY

- Atmospheric effects on radio & radar propagation
- Signal & Noise Studies
- Estimation Techniques
- Smoothing & Prediction Theory
- Aerodynamics Heating & Heat Transfer
- Error Analysis
- Electronically Scanned Antennas
- Modulation Theory

AVIONICS LABORATORY

- Electronic Systems Design & Development
- Microwave & Antenna Research & Development
- Electronic Packaging & Test Design
- Computer Systems Engineering & Logical Design
- Technical Coordination & Liaison

APPLIED RESEARCH LABORATORY

- Operations Research
- Communications Theory
- Automatic Controls
- Airborne Interceptor Radar
- Infra-Red Systems
- Radar Simulators
- Missile Electronics

For positions at Waltham, Mass. please send your resume to Erling Mostue Waltham Laboratories, 100 First Avenue Waltham, Massachusetts

ELECTRONIC SYSTEMS DIVISION

 **SYLVANIA** 

SYLVANIA ELECTRIC PRODUCTS INC.

EMERSON ELECTRIC

ELECTRONICS AND AVIONICS DIVISION

NEEDS ENGINEERS!

- Electronic Engineers (radar, computer, servo)
- Electronic Packaging Engineers
- Electronic Test Equipment Designers
- Electrical Engineers
- Liaison Engineers (electronics background)

Attending the IRE Convention and Show in New York City, March 18—21? Mr. Paul Brannan, our Ass't. Chief Engineer, and Mr. A. L. Depke, our Employment Supervisor, will interview in New York City, Sunday through Wednesday, March 17—20. While there, be sure to call them for appointment at PLaza 9-7200.

**EXCEPTIONAL OPPORTUNITIES, RAPID ADVANCEMENT,
FASCINATING WORK ON ADVANCED PROJECTS... B-58
HUSTLER, F-101 VOODOO AND MANY OTHERS!**

- Top-level salaries
- Full scale long range expansion program underway
- Big company benefits, small company individuality
- Liberal group insurance and retirement plans
- Excellent air conditioned facilities
- Fully paid transportation and moving expenses to St. Louis

Emerson's Electronics and Avionics Division projects include the B-58 fire control system, servo mechanisms computers, radar assemblies, mortar tracking devices, missiles and rockets, F-101 Voodoo structures, other electronic fire control systems and supersonic airframe structures, and aircraft components.

Emerson Electric is a medium size company (5000 employees, 850 engineers) and a national leader since 1940 in design, development and manufacture of electronics and avionics products. Our Commercial Division, established 1890, produces a complete line of fans, motors, air conditioners, heaters, welders and power tools. This perfect balance of electronic, aircraft and consumer production assures stability and security in your career at Emerson.

We're ideally located in beautiful, suburban St. Louis, noted for its unusual friendliness. Our people enjoy relaxed town and country living, with easy access to metropolitan stores, entertainment, cultural, medical and educational facilities. Driving time to work is 5 to a maximum of 30 minutes, unhampered by traffic congestion. St. Louis combines the four seasons into a delightful 'national climate' with low averages of 30.6° in Jan. and high of 79.3° in Aug. Only one day reached 100° in 1956.

YOUR FUTURE IS OUR BUSINESS!

Write us, if you are not planning to be at the IRE Convention, and include a brief resume of your education, business background and approximate salary requirements. Send to R. L. Middleton, Employment Manager.

ELECTRONICS AND AVIONICS DIVISION

EMERSON ELECTRIC

8100 W. Florissant

St. Louis 21, Mo.

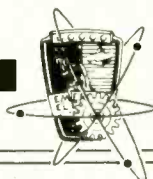

Engineers do better at
BENDIX PRODUCTS DIVISION

You can complete your graduate study at
The UNIVERSITY of NOTRE DAME

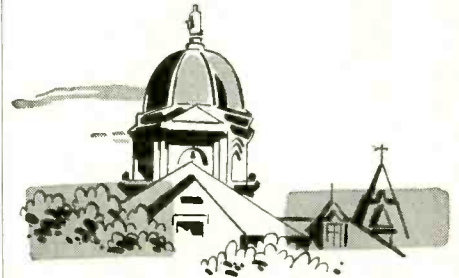

and work at one of these stimulating assignments

- SYSTEMS ANALYSIS
- HYDRAULIC CONTROLS
- SERVOMECHANISMS
- ROCKET CIRCUITRY • HEAT TRANSFER
- MAGNETIC AMPLIFIERS
- COMPUTER APPLICATIONS
- NUCLEAR ENGINE CONTROLS
- TRANSISTORIZATION
- TESTING • VIBRATIONS
- STRUCTURES & STRESS
- ELECTROMECHANICAL DESIGN
- AIRCRAFT

If you are interested in a good starting salary and a successful engineering career, send a summary of your educational and practical background to:

Administrative Engineering
Bendix Products Division
203 Bendix Drive, South Bend, Ind.



*The broader the base
the brighter the future*

It just makes good sense—the range of job opportunities is far wider and advancement opportunities greater with a company operating on the sound basis of diversified engineering and manufacturing.

COMMUNICATIONS SYSTEMS ENGINEERS

The expanding scope of advanced communications projects has created several unique positions in fields related to VHF, UHF, microwave transmission and reception, forward scatter and single sideband applications at Hoffman. Electronics engineers with appropriate backgrounds will find these new assignments professionally stimulating and financially rewarding. Please write Vice President of Engineering.

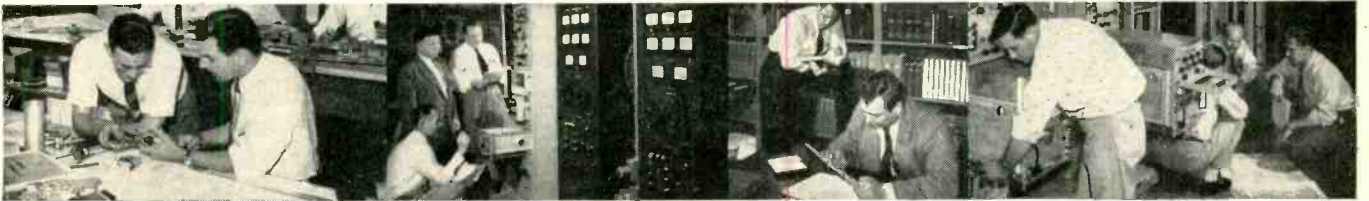

I.R.E. CONVENTION

March 18th-21st

Senior Members of the Hoffman Technical Staff will be available for interview at the Convention Hotel — Please telephone EL 5-3456 for appointment.

Hoffman LABORATORIES, INC.

A SUBSIDIARY OF HOFFMAN ELECTRONICS CORP.

3761 South Hill Street
Los Angeles 7, California
Telephone: RIchmond 9-4831

ENGINEERS & SCIENTISTS

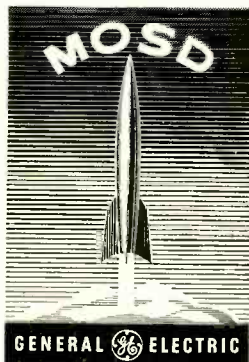

SYMBOL OF ADVANCED
THEORY AND RESEARCH IN
THE GUIDED MISSILE FIELD

This General Electric department is prime contractor for "Intercontinental Ballistic Missile" and "Intermediate Range Ballistic Missile" nose cone development. Increasing emphasis on this and other guided missile programs continues to create openings on our professional staff for graduate engineers and scientists with experience in the following or related fields:

MATERIALS & PROCESSES • AERODYNAMICS • AEROPHYSICS • THERMODYNAMICS • ELECTRICAL DESIGN • STRUCTURAL DESIGN • STRESS ANALYSIS • DATA PROCESSING • SYSTEMS • SYSTEMS TEST • FIELD TEST • VIBRATION • INSTRUMENTATION • CONTROLS • ARMING AND FUZING • INERTIAL GUIDANCE • GROUND SUPPORT EQUIPMENT DESIGN

We would be pleased to receive a resume of your education and experience in order to arrange a personal interview with the manager of the appropriate technical area. Please address all correspondence to:

MR. JOHN WATT • ROOM 540-4
MISSILE & ORDNANCE SYSTEMS DEPARTMENT
GENERAL ELECTRIC

3198 CHESTNUT STREET, PHILADELPHIA 4, PA.

Admiral®

has a future for
Engineers—Physicists in
**NUCLEAR RADIATION
DAMAGE CONTROL**

SENIOR PHYSICIST

Ph.D. with nuclear engineering background, to evaluate nuclear radiation damage to electronic components, to develop techniques in radiation instrumentation and to develop methods and materials suitable for use in components subjected to high level nuclear environments. Work involves experimentation with reactors and multikilocurie cobalt source.

NUCLEAR INSTRUMENTATION

Engineer familiar with Geiger counters and ionization chamber radia instruments, to assist group leader in developing contract and proprietary items in the nuclear instrument field.

Career-minded men with several years specialized experience are invited to join our rapidly expanding program. Current openings offer excellent income and employee benefits including retirement plan, paid group insurance and college tuition refund plan plus ideal working conditions. On-the-job training for junior and intermediate engineers.

If you are qualified in either of these fields, explore your opportunity with Admiral today. Write Mr. Walter Wecker, Personnel Manager.

Admiral Corporation

3800 W. CORTLAND STREET
CHICAGO 47, ILLINOIS

**OPPORTUNITIES at
PALO ALTO RESEARCH CENTER**

The development of new technologies at Admiral's Palo Alto Division opens the door on a program of advanced research and development for aeronautical electronics.

These positions for experienced and intermediate level engineers have excellent growth potential. Send complete resume and salary requirements to:

Mr. Robert M. Jones

Admiral Corporation

901 California Avenue, Palo Alto, California

**ELECTRONIC
TUBE
ENGINEERS**

Old established company setting up new Electronic Division needs research and development engineers experienced in special purpose electron tubes including cathode ray and gas filled. Here is the opportunity to grow with new product effort and improve your future potential.

P-4101—Electronics

520 N. Michigan Ave., Chicago 11, Ill.

ELECTRONIC SCIENTISTS and ENGINEERS
ELECTRONIC SYSTEMS SPECIALISTS

A message of interest to all electronics men

Why Republic Aviation is forming its own Electronics Research Group

Electronic mechanisms take so vital a role in high performance jetcraft and missiles that it is no longer permissible to limit their performance with "ground engineered" components. Republic has recognized this critical need for electronic units developed and designed by air-minded men. Because of this, electronic *flight* research is being made an integral part of integrated research in aerophysics at Republic—a "first," we believe, for Republic in the aircraft industry.*

Research and development programs are already well into the planning stage. Complete facilities are being provided at Republic's Farmingdale, Long Island installation in which electronics specialists and physicists will find broad avenues for original and rewarding work.

Under the leadership of Dr. Theodore Theodorsen, Director of Republic's Scientific Research Staff, they will apply the principles of electronics to varied problems in missiles and weapons systems.

EXPERIMENTALISTS AND THEORETICIANS

with advanced degrees will discover unparalleled opportunities for creative air-minded research in:

Information Theory and Data Transmission • Digital & Analog Computers • Servo Systems • Semiconductors, Magnetics and Electron Physics • Acoustics • Radar Systems Analysis • Infra-red Techniques • Antenna Design



SYSTEMS SPECIALISTS

with graduate training and substantial experience will find professional fulfillment in:

Reconnaissance • Navigation • Communications • Search, Identification and Tactical Control • Flight Control • Fire Control • Bomber Defense • Weapons Delivery • Missile Guidance • Countermeasures • Air Terminal Control

Long Island offers the ultimate in pleasant living in the East. Recreational facilities of every sort abound—cultural centers are within easy reach—communities are clean, new and friendly.

Qualified scientists and engineers who wish to participate in this exciting new endeavor in aircraft or missiles should send a complete technical and personal resume to:

Mr. George Hickman Engineering Employment Manager



REPUBLIC AVIATION

FARMINGDALE, LONG ISLAND, NEW YORK

*Other firsts were Republic's Thundercraft, latest, most lethal and versatile of which is the incredible F-105 Thunderchief, supersonic USAF fighter-bomber, capable of delivering nuclear loads.



▲ Plant of Westchester manufacturing subsidiary, Pleasantville Instrument Corporation; additions are under construction.

Latest GPL engineering building, for which ground was broken recently. ▶

Electronics Engineers



◀ Plant of Bloomfield, N. J., manufacturing subsidiary, Simplex Equipment Corporation; added in 1957.

New GPL environmental test lab, most modern of its kind, now nearing completion. ▼

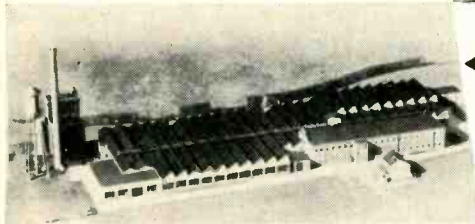

GPL keeps GROWING

... how about YOU?

You can find opportunity in many places, but you can find more of it at GPL. As a result of GPL's brilliant scientific break-through in harnessing Doppler to air navigation, scores of new development and production opportunities have been created. We need electronics engineers who can keep pace with us and, more important, help set the pace for future growth.

You can find security in many places, but here at GPL you get a double measure. You participate in the secure strength of the nationwide GPE Group. Top salaries and ideal working conditions give you the peace of mind to enjoy pleasant living in semi-rural surroundings, less than an hour away from New York City.

Greater opportunity and more security—for yourself and your family—are a part of every job here at GPL.

<p>In connection with DOPLER & INERTIAL Air Navigation and Guidance Systems we have openings for work on Computers, Magnetic Amplifiers, Servos, Microwave Techniques, Transistorization, IF Amplifiers and Pulse Circuitry.</p>	<p>Research & Development: Applications • Systems Analysis • Systems Test • Mechanical Design • Mechanical Packaging • Project Engineering • Component Specification and Test • Proposal Writer • Contract Administrator.</p> <p>Manufacturing Engineering: Systems Test • Quality Control • Mechanical Design • Production Follow-up.</p> <p>Field Engineering: At Military Installations and Airframe Manufacturers' Plants.</p>
---	---

Send your resumé to: Mr. Richard E. Hoffman, Employment Manager. We will pay the expenses of qualified applicants to come for an interview.



General Precision Laboratory Incorporated
63 Bedford Road, Pleasantville, New York

MECHANICAL ENGINEERS-

Pioneer for Growth...

A challenging future with a small growth company is offered the engineer who is interested in a career opportunity utilizing his training and technical know-how.

Responsible engineering positions exist in the machine design and development of xerographic equipment. Xerography, a process for forming and using electrostatic images, is widely used in the copying and duplicating fields. It is being developed for fascinating applications in automatic data processing, photography, office equipment, engineering drawing systems and interesting military applications.

Opportunities are available at all levels. There are openings also in product improvement and engineering standards work. Assignments are largely of the electro-mechanical type with a variety of optical, lighting, and electrostatic problems.

Previous experience in the design of office equipment or photographic equipment (military or commercial) would be helpful.

- Comprehensive Employee Benefit Program
- Exceptional Tuition Refund Program
- Ideal living and recreational area



Kindly send resume and salary requirements to:

DAVID S. RAUB
Industrial Relations Division
THE HALOID COMPANY
Rochester 3, New York

STARTING AT THE BOTTOM

by dahl

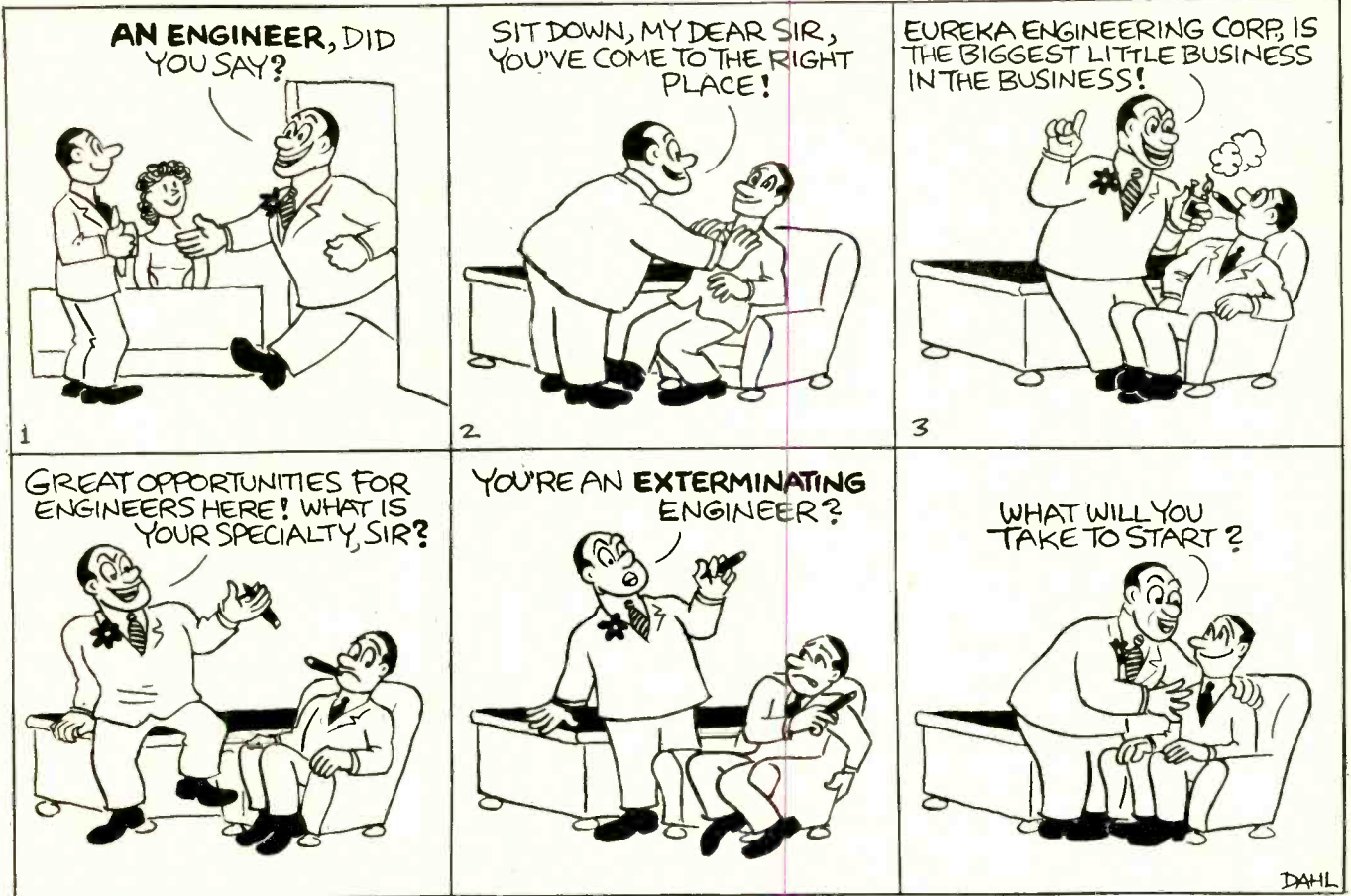

For information regarding
Engineering Positions
 in the
Microwave and Power Tube Operations
 Write D. Hamant

RAYTHEON MANUFACTURING COMPANY

Waltham 54, Massachusetts



Excellence in Electronics

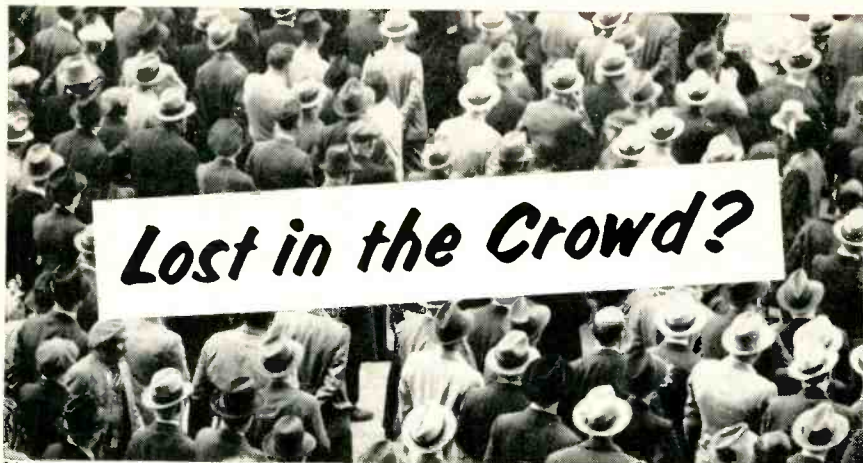

Lost in the Crowd?

You will find . . .

PERSONAL RECOGNITION

at Westinghouse

Electronic Tube Div., Elmira, N. Y.

YOUR accomplishments will be recognized and rewarded at our rapidly expanding Electronic Tube Division. You will enjoy a healthy "climate" for creative engineering.

Join us in advancing into challenging new spheres as you design, develop and manufacture the revolutionary electronic tubes that science will use tomorrow.

Merit recognition plus regular salary increase insure a growing income for you. In-plant training will enable you to progress into specialized fields if you wish.

You and your family will enjoy this delightful upstate community. Excellent schools, churches, residential areas within minutes' drive. Near the famous Finger Lakes vacation-land.

Do you want an opportunity to advance in your chosen field? Investigate these unusual assignments in Electronics, Chemistry and Physics.

- MANAGERS
- RESEARCH ENGINEERS
- DESIGN ENGINEERS
- PROJECT ENGINEERS
- MANUFACTURING ENGINEERS
- MACHINE DESIGN ENGINEERS
- TECHNICIANS

IRE MEMBERS!
 While at the Show
 in New York,
 visit Westinghouse
 Booths 1402 thru 1408,
 and 1601 thru 1607.

Send resume to Mr. W. Kacala, P. O. Box 284, Dept. M-3F, Elmira, N. Y., or phone collect Elmira 9-3611. Evenings or weekends, phone 2-2139.

Westinghouse
 ELECTRONIC TUBE DIVISION ELMIRA, NEW YORK



**SALES ENGINEERS
 ELECTRONIC INSTRUMENTATION**

To a competent, intelligent engineer with sales ability, or an experienced sales engineer seeking a change, we offer an exceptional career opportunity combining engineering and sales. Income potential, after training, is far greater than that offered in engineering alone and is limited only by ability and performance.

Our company is the fastest growing Sales Engineering organization in the East, representing a number of the foremost manufacturers of *Electronic Instruments and Components, Automation Systems and Nuclear Equipment*. You will join a well co-ordinated, smoothly operating team of young sales engineers who enjoy their work and are enthusiastic about their present and their future.

Applicants should be between 26 and 35, with a degree in EE or Physics, and have experience in working with electronic instrumentation. They must be able to assimilate technical information rapidly and present it well. In addition the position requires initiative, maturity, enthusiasm, good business judgement and the ability to assume responsibility.

Send resume in confidence to:
 Gerard G. Leeds Company
 12 Crampton Lane, Great Neck, N. Y.
IRE Show interviews will be arranged.

GERARD G. **LEEDS**
 COMPANY
SALES ENGINEERS

**Electrical Engineers
 Mechanical Engineers
 Physicists**

**PRINCETON-PENNSYLVANIA
 SYNCHROTRON**

Get
 Research
 Experience
 And
 Training

Our
 Program
 Promises
 Opportunity in
 Research
 That offers
 Unlimited
 New Horizon of
 Interest
 To
 You

Under contract with the AEC, Princeton and the University of Pennsylvania are designing a 3-billion volt, high intensity proton synchrotron to be built at the James Forrestal Research Center in Princeton. Outstanding opportunities for engineers and physicists in unclassified research are now available.

Salaries commensurate with ability. Live and work at Princeton in an academic surroundings with University benefits.

Send resume or inquiry to:
 Silas Spengler
 Committee on Project Research and Inventions
 123 Pyne Administration Building
 Princeton University
 Princeton, New Jersey

Electronic Systems Engineers:



Why you should give serious thought to SYLVANIA'S NEW electronic research & development lab in Buffalo...

If you want all the advantages of a career in the fast-growing electronics industry, you should know the facts about Sylvania's new multi-million dollar Electronic Research and Development Center... opening late in 1957, the newest development in the company's phenomenal growth as a producer of complex military electronic systems.

Engineers who join us now will find opportunities for advancement that are impressive even for the young electronics industry. The company helps its men get ahead by sponsoring graduate study at the University of Buffalo's fine engineering school.

The location permits you to live and work in a most attractive suburb — Amherst, a choice residential area, only 7 miles from downtown Buffalo, second only to New York City in New York State, is progressive and alert, famed for its friendliness, and boasts an excellent public school system. The gateway to Canada, next door to Niagara Falls, it offers easy access to famous Eastern and Great Lakes resorts.

Immediate Openings in Applied Research

ADVANCED CIRCUITS SPECIALISTS

With ingenuity, ability and interest to create operable circuits required to bring to fruition radically new theoretical concepts in the field of communications. Requires 10 years experience and proven ability to supervise work of a group of engineers creating original circuit designs. Techniques include: transistor applications, digital computer design, and a variety of novel video-radio frequency circuits, as well as modulation in unconventional dimensions.

ELECTRO-MAGNETIC PROPAGATION SPECIALIST

Should have 10 years experience and ability to supervise the work of a group of advanced research engineers searching for the solutions to problems in multipath transmission as a function of frequency; vector scatter propagation, broad band antenna design, etc., which are necessary in the utilization of new communications systems.

COMMUNICATIONS SYSTEMS SPECIALIST

Opening for an engineer with vision and creative ability to derive and direct applications of new techniques developed in Buffalo Engineering Laboratory to existing and newly developed systems. These techniques now permit solution of many long-standing problems which exist in fields ranging from radio to radar or sonar from radio teletype to DME. Should have at least 10 years experience in communications field and an interest in system synthesis and analysis. Advanced degree in Electrical Engineering, Physics, Mathematics or equivalent in course work on a graduate level is desirable.

Please send your resume to E. F. Culverhouse

175 GREAT ARROW AVENUE

 **SYLVANIA** 
SYLVANIA ELECTRIC PRODUCTS INC

BUFFALO, NEW YORK

TOP ENGINEERING POSITIONS

Norden-Ketay Corporation's management plan for 1957 provides for a further and continued emphasis on professionalism and creative ability.

Due to our immediate expansion plans our immediate needs are for the filling of several positions on the junior level as well as on the senior level.

The senior engineer is afforded the opportunity of full expression of engineering creativity as well as management direction.

**BRANCH HEAD
ROTATING COMPONENTS**

5 to 7 years experience in Rotating Components field. Supervisory experience essential. Will have responsibility of complete branch. Report directly to chief engineer.

**SECTION HEAD
SERVO MOTORS**

3 to 5 years experience in design and development of torque type rotating components. (Servo motors, damps, blower motors.) Capacity to supervise engineers and technicians. Report directly to branch head.

**RESOLVER
DESIGN ENGINEER**

Minimum of 1 year's experience in rotating components design.

**SR. TRANSISTOR ENGINEER
TO HEAD UP ELECTRONIC AMPLIFIER
SECTION**

THERE ARE SEVERAL POSITIONS AVAILABLE FOR INTERMEDIATE & JUNIOR LEVELS IN THE ABOVE CATEGORIES.

DRAFTSMEN

Designers, Detailers, Layout Men

Positions available for juniors as well as men with experience in precision electromechanical components, servos, synchros, gear trains and amplifiers. Ability to work with minimum of supervision preferable.

WE WILL PAY TOP RATES IN FIELD

WE HAVE ALL THE FRINGE BENEFITS

We have always paid top salaries and will continue to, but our chief asset is the challenging opportunities for professional and academic growth.

Retirement income and tuition refund plan are just a few of the basic benefits.

Relocation expenses paid.

All resumes will be held in strict confidence. Submit to Technical Personnel Manager or phone F0rest 8-5500 for appointment.

After hour and weekend interviews arranged.

NORDEN-KETAY CORP.

PRECISION COMPONENTS DIVISION
Broadhollow Road & Allen Boulevard
Route # 110 Farmingdale, L. I., N. Y.

**TECHNICAL
WRITERS**

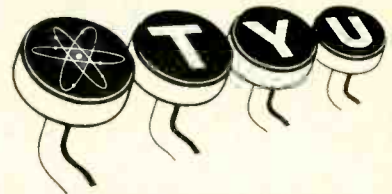

... to write handbooks on electronic equipment for the Armed Services

If you have a good background in Electronics, here is an unmatched opportunity to grow with Stromberg-Carlson's booming Electronics Division.

Excellent working conditions ... ideal living in a beautiful upstate New York community.

Send complete resumé to

R. W. Holmes



STROMBERG-CARLSON

A DIVISION OF GENERAL DYNAMICS CORP.
26 Carlson Rd. • Rochester 3, N. Y.

**ELECTRONICS
ENGINEERS**

Opportunities in

SOUTHWESTERN NEW ENGLAND

If you have had experience in circuit design and packaging of electronic apparatus for missiles, you have acquired a background applicable to our problems.

These positions at our research laboratory in Ridgefield, Connecticut, are permanent for personnel with knowledge and experience in such areas as feedback circuitry, transistorization, signal-to-noise considerations, pulse circuitry, phase selection, and telemetering.

**THE PROJECTS ARE NOVEL
AND CHALLENGING**

The positions require an S.B. or E.E. degree, with at least 3 years industrial experience in electronic circuitry design and apparatus development.

Working conditions are excellent and employee benefits liberal.

Send resume to:

**SCHLUMBERGER
WELL SURVEYING CORPORATION**

Old Quarry Road Ridgefield, Connecticut

**PROJECT ENGINEERS
SENIOR ELECTRONIC ENGINEERS**

Three to five years experience control, servos, computers and components.

Starting salaries to \$12,400

ANALOGUE CONTROLS, INC.

39 Roselle Street Mineola, N. Y.
Pioneer 2-8901

EMPLOYMENT PROBLEM?

When you are in need of specialized men for specialized jobs, contact them through an employment ad in this publication.

ELECTRONICS

Classified Advertising Division
P. O. Box 12, New York 36, N. Y.

ENGINEERS, EE-ME

**NOW,
A 5-MAN
PRODUCT
DEVELOPMENT
TEAM**

Citizenship not required

**TO SPEARHEAD CREATIVE PROGRAM IN
CONSUMER PRODUCT DEPARTMENT**

at General Electric's Radio Receiver Dept.

Have you been looking for an opportunity to do creative work in a small group responsible for forward-looking programs?

General Electric's Radio Receiver Department now offers you the chance to develop new techniques and circuit applications for existing and new products that will reach the consumer market in 2 to 3 years.

If you've had up to 4 years experience in mass-produced consumer goods—or related training—then your opportunity for professional advancement begins here. You'll start with a new 5-man team, now forming, and will receive the training you need to fit into our expanding program and advance your professional career.

As a G-E engineer, you will naturally benefit from our promotion-from-within policy plus the numerous other personal and professional advantages including our FULL TUITION REFUND PLAN for graduate studies.

You'll also like living in friendly Utica, famed for its wealth of all-season sports and recreation facilities.

Send your resume in confidence to:

Mr. R. P. Stitt
RADIO RECEIVER DEPARTMENT
GENERAL  ELECTRIC
869 Broad Street, Utica, N. Y.

2 CAREERS in 1...

When you build a career at **FTL** ... you build a career with the **ITT System!**

"TWO Careers in ONE" exemplifies one of the many reasons why Federal Telecommunication Laboratories is such a distinctive place to work and grow.

Achievement at FTL not only brings professional recognition, but simultaneously enhances your stature as a member of International Telephone and Telegraph Corporation's distinguished engineering team!

FTL's "small-company" project system provides unlimited opportunities for advancement. Assignments in FTL's eight laboratories are of the highest calibre and national importance... facilities are the finest. Stability is assured by FTL's long-range, diversified program and extensive expansion on the East and West Coasts. All popular medical-surgical, pension and insurance benefits are available. Typical assignments at our East Coast Laboratory include:

- Radio Communication Systems • Traveling Wave Tubes
- Electronic Countermeasures • Air Navigation Systems
- Antennas • Missile Guidance • Computers
- Transistors and other Semiconductor Devices
- Telephone and Wire Transmission Systems

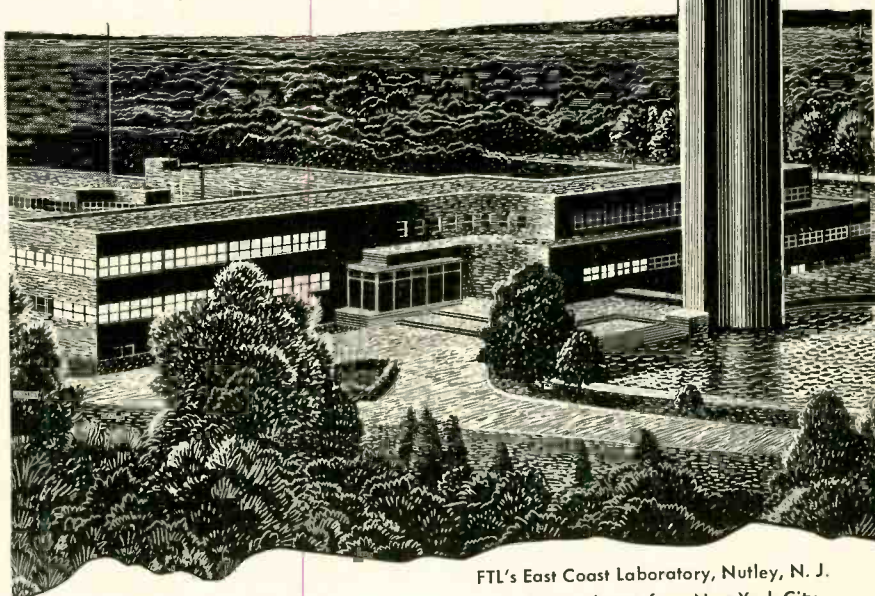

FTL's East Coast Laboratory, Nutley, N. J.
—only 28 minutes from New York City

If you prefer CALIFORNIA—

- Opportunities for relaxed living and career-building also available at FTL's West Coast Laboratory... with openings in Digital Computers, Inertial Navigation Systems and Infra Red Systems. Write to 15191 Bledsoe St., San Fernando, Cal.

FTL



MAIL THIS COUPON TODAY

Federal Telecommunication Laboratories
500 Washington Avenue, Nutley, N. J.
Please send literature describing opportunities and benefits at FTL, in Nutley, New Jersey.

Name _____
Address _____
City _____ Zone _____ State _____

Federal Telecommunication Laboratories
A Division of INTERNATIONAL TELEPHONE AND TELEGRAPH CORPORATION

COMMUNICATIONS ENGINEERS and TECHNICIANS

EXCELLENT SALARIES
MINIMUM PREREQUISITES

ENGINEER EE Graduates with 3 years experience
TECHNICIAN 2 years technical school in communications and 3 years experience.

Require installation adjustment and maintenance experience with communication receivers and associated terminal equipment. Also, men with similar experience with high-powered transmitters, antennas, transmission lines.

Must be willing to travel in United States and Overseas

Page Communication Engineers, Inc.
710 Fourteenth St., N.W., Washington 5, D.C.

ENGINEER — Magnetics. Outstanding opportunity for E.E. familiar with modern Magnetic Theory to perform development work on such components as magnetic amplifiers and saturable reactive devices. Please write Hycor, Division of International Resistance Company, 12970 Bradley Ave., Sylmar, California.

Electronic Engineers
Mechanical Engineers
Advancement... Security
...Responsibility

Professional personnel needed at all levels to fill responsible openings at this steadily expanding Division of Bendix Aviation Corporation. It's your chance to get specific assignments at the peak of the art in ELECTRONICS and MICRO-WAVE DEVELOPMENT and DESIGN. Good salaries, all employee benefits, ideal suburban living conditions. Whether you be a Department Chief or a Junior Engineer with less than one year's experience, we have the opening and the shoes for you to fill.

Address: Chief Engineer Dept. H

Bendix
AVIATION CORPORATION
York
DIVISION
York, Penna. York 47-2611

TELEVISION ENGINEERING HANDBOOK

- Prepared by a staff of 33 Specialists
- 1483 pages, 6 x 9
- Hundreds of charts, circuits, tables, and illustrations

\$15.00

Full 10 days' examination before you decide to purchase. See coupon.

All your design work is made easier and faster with the help of this comprehensive guidebook. It covers the entire field of television technology, including not only the basic fundamentals, but practical design data for transmitters, receivers, and networks. Monochrome and color television are treated in equal detail, and there is coverage of the related topics of vision, photometry, illumination, optics, and colorimetry.

Look to this handbook for quick help on the countless questions arising in your daily work—on television standards for scanning, modulation, synchronization—on band and channel designations—on camera and picture tubes—on circuit functions and design—on transmission lines and radiators—and many other topics, covered in the 20 big, authoritative sections of this new working tool.

TRANSISTORS

HANDBOOK OF SEMICONDUCTOR ELECTRONICS

Edited by LLOYD P. HUNTER

Senior Physicist, International Business Machines Corporation, Poughkeepsie, N. Y.
604 pages, 6 x 9, 484 illustrations, \$12.00

This book gives you a rounded view of semiconductor devices—all the help you need to prepare for practical circuit design and engineering of applications utilizing transistors, diodes, or photocells. Emphasis is on actual circuit design. The extensive section on this subject covers the use of semiconductor devices in bandpass and video amplifiers, computers, measuring instruments, industrial control equipment, oscillators, etc. In addition, theory of semiconductor devices, important aspects of how they are made, and background of analysis and measurement is given, to provide engineers with an intensive one-volume treatment of this growing new field.

CONTROL CIRCUITS

HANDBOOK OF INDUSTRIAL ELECTRONIC CONTROL CIRCUITS

By JOHN MARKUS and VIN ZELUFF

Electronic
352 pages, 8 1/2 x 11, illustrated, \$8.75

Here are the circuits you need for sorting, timing, measuring, and counting; for sweep control, triggering, temperature and motor control, and hundreds of other industrial uses—each with concise description, performance characteristics, component values, and practical applications. Save hours of search and preliminary work to find basic circuit ideas for particular applications—consult this big, handy collection of tested circuits—selected from recent issues of *Electronics* and classified and indexed for quick use.

ELECTRONIC ENGINEERS PROJECT ENGINEERS TECHNICIANS AND TESTERS

Locate on Long Island. We have staff and key positions open. Salary from \$12,000. Liberal company benefits. Interesting projects.

MUNSTON MFG. SERVICE, INC.
Beech Street Islip, New York
Juniper 1-3900

HRB e.e.'s and physicists

A rewarding future is waiting for you at HRB. You will live in State College, a few minutes walk from the Pennsylvania State University. Located among the scenic Nittany mountains of central Pennsylvania, State College offers the congenial atmosphere for young family growth. Some of the finest hunting and fishing areas in the United States are located in the area. HRB, one of the country's fastest growing research companies offers excellent salaries and generous company benefits.

For application form, write:
Technical Personnel Officer
Haller, Raymond & Brown, Inc.
State College, Pennsylvania

JUST MAIL THIS FREE EXAMINATION COUPON

McGraw-Hill Book Company, Inc., Dept. L-3
327 West 41st St., New York 36, N. Y.

(Print) Name

Send me book(s) checked below for 10 days' examination on approval. In 10 days I will remit for book(s) I keep, plus few cents for delivery costs, and return unwanted book(s) postpaid. (We pay delivery costs if you remit with this coupon—same return privilege.)

Address

City & Zone State

Fink—Television Engg. Hdbk., \$15.00

Company

Hunter—Hdbk. of Semiconductor Electronics, \$12.00

Position

Markus & Zeluff—Hdbk. of Indus. Electronic Control Circuits, \$8.75

L-3

For price & terms outside U. S., write McGraw-Hill Intl. N. Y. C.

Admiral

has a future for
Engineers—Physicists in
**NUCLEAR RADIATION
DAMAGE CONTROL**

SENIOR PHYSICIST

Ph.D. with nuclear engineering background, to evaluate nuclear radiation damage to electronic components, to develop techniques in radiation instrumentation and to develop methods and materials suitable for use in components subjected to high level nuclear environments. Work involves experimentation with reactors and multikilocurie cobalt source.

NUCLEAR INSTRUMENTATION

Engineer familiar with Geiger counters and ionization chamber radiac instruments, to assist group leader in developing contract and proprietary items in the nuclear instrument field.

Career-minded men with several years specialized experience are invited to join our rapidly expanding program. Current openings offer excellent income and employee benefits including retirement plan, paid group insurance and college tuition refund plan plus ideal working conditions. On-the-job training for junior and intermediate engineers.

If you are qualified in either of these fields, explore your opportunity with Admiral today. Write Mr. Walter Wecker, Personnel Manager.

Admiral Corporation

3800 W. Cortland Street
Chicago 47, Illinois

ENGINEERS

**Advances in Military
Electronics Today . . .
Pave the Way for
Commercial Developments
Tomorrow
At Otis' Electronic Division**

The full resources of the century-old Otis Elevator Company are available for expansion of its new Electronic Division. And engineers who join this division now will have the satisfaction of working in the forefront of the military electronics field . . . with the realization that its potentialities in commercial development will also be explored by Otis . . . that this is a long-range program in which Otis will spare no effort in broadening the position of its Electronic Division as a leader in this important field of industry.

Current prime contracts are on basic development work in the most advanced areas of bombing navigation systems, radar systems and missile launching test equipment.

Engineering know-how is required in servo-mechanisms, analog computers, pulse and sweep generators and in the field of microwaves.

If you are interested in a high level career in electronics . . . with promotions waiting to be earned . . . send your resume now to William B. DeFrancis. All inquiries in strict confidence.

ELECTRONIC DIVISION

Otis Elevator Company

35 Ryerson St. Brooklyn 5, N. Y.

HOW DO YOU GROW AT ARMA?

Through diversification!

In our recent advertisements, we spoke of the growth opportunities offered by Arma. Almost immediately, perceptive engineers began writing us, asking for more information.

"How does an engineer grow at Arma—precisely?"

Our answer, in a word, is *diversification*. Arma offers one of the broadest programs of work diversification in the electronics field.

At Arma, an engineer follows a project from original design, right through final production. As a result, our engineers and scientists are exposed to many activities not usually found under one roof—areas into which they can grow, as their abilities and interests lead them.

Here are some of the areas—69 examples—in which Arma concentrates its efforts in:

MISSILE CONTROLS & GUIDANCE and FIRE CONTROL

1.0 SYSTEMS DEVELOPMENT

- 1.1 Digital Computers
- 1.2 Autopilots
- 1.3 Infrared
- 1.4 Electromagnetic Devices
- 1.5 Gyroscopics
- 1.6 Inertial Platforms
- 1.7 Missile Guidance
- 1.8 Fire Control
- 1.9 Servos

2.0 PROJECT ENGINEERING

- 2.1 Airborne Fire Control
- 2.2 Airborne Armament
- 2.3 Air-to-Air Missiles
- 2.4 Semi-Automatic Test Equip.
- 2.5 Air Traffic Control
- 2.6 Optical Systems
- 2.7 Stabilizing Devices
- 2.8 Submarine Fire Control
- 2.9 Electronic Test Equipment

3.0 SYSTEMS EVALUATION

- 3.1 Instrumentation Evaluation
- 3.2 Telemetry
- 3.3 Data Reduction
- 3.4 Data Analysis
- 3.5 Project Engineering
- 3.6 Data Process Planning
- 3.7 Control Circuitry Design

4.0 SYSTEMS ENGINEERING

- 4.1 Trajectory Analysis
- 4.2 Airframe Performance
- 4.3 Weapons Control
- 4.4 Operations Research
- 4.5 Radar
- 4.6 Error Analysis
- 4.7 Reliability

5.0 COMPONENTS

- 5.1 Transistors
- 5.2 Magnetic Amplifiers
- 5.3 Synchros
- 5.4 Tachometers
- 5.5 Accelerometers
- 5.6 Resolvers
- 5.7 Integrators

6.0 RADAR

- 6.1 CW Doppler Systems
- 6.2 Antenna Design
- 6.3 Components
- 6.4 Pulse Circuitry
- 6.5 Countermeasures
- 6.6 Laboratory Evaluation

7.0 PROJECT ADMINISTRATION

- 7.1 Project Planning & Control
- 7.2 Sub-Contracted Liaison
- 7.3 Contracts Evaluation
- 7.4 Project Coordination

8.0 DIGITAL COMPUTERS

- 8.1 Logical Design
- 8.2 Dynamic Analysis
- 8.3 Circuit Development
- 8.4 Component Development
- 8.5 Packaging
- 8.6 Field Evaluation

9.0 ENVIRONMENTAL

- 9.1 Vibration
- 9.2 Shock
- 9.3 System Test
- 9.4 Component Test
- 9.5 Materials Analysis
- 9.6 Dynamics

10.0 MISSILE GROUND EQUIP.

- 10.1 Operations Techniques
- 10.2 Count-down Equipment
- 10.3 Launching Control Instrumentation
- 10.4 Control Circuitry
- 10.5 Automatic Test Equipment
- 10.6 Console Integration
- 10.7 Remote Data Recording
- 10.8 Optical Monitoring

If you want to participate in the growth that *must* come to a man working in so diversified an environment, write and tell us the area in which you're most interested. (Or use the coupon below.) Your confidence will be respected, and you will hear from us promptly. If you prefer, forward confidential resume. No reference contact without your permission.

Technical Personnel Department E-674



Division of American Bosch Arma Corporation
Roosevelt Field, Garden City, Long Island, N. Y.

Gentlemen:

Please send me additional information concerning the job numbered _____

Or, additional information concerning the area of _____
(state interest if not in above listing)

NAME _____

ADDRESS _____

CITY _____

ZONE _____ STATE _____

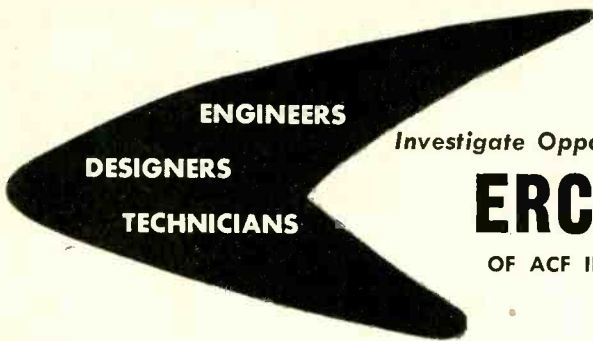

Investigate Opportunities at

ERCO DIVISION
OF ACF INDUSTRIES INC.

ERCO Engineers have built a record of continuous progress and growth for themselves and for the Company for a quarter of a century . . . growth in physical plant, personnel, number and diversity of products and services.

Today this growth continues and we are constantly on the alert for new men to add fresh impetus to that progress . . . paying top salaries to capable people.

Your work will be interesting and stimulating . . . it might include electronic flight simulators, machine tools, guided missiles, or a variety of specialized electronic devices.

You can choose a home from a number of fine nearby residential areas convenient to both shopping centers and plant . . . and you can further your education at the many nearby Universities . . . you can enjoy suburban living and be within easy reach of the cultural advantages of the Nation's Capital.

ERCO now needs Electronic Engineers (all levels with some overseas positions available), Aerodynamicists, Analog Computer Engineers, Mechanical Design Engineers, and supporting personnel. Send resume or request for additional information to:

ERCO DIVISION
OF ACF INDUSTRIES
RIVERDALE • MARYLAND

TENNESSEANS

..... who would like to return to your home state—and other engineers who want to get in on the ground floor in one of the South's most progressive and beautiful cities:

Tennessee offers you good living—outdoor sports the year round.

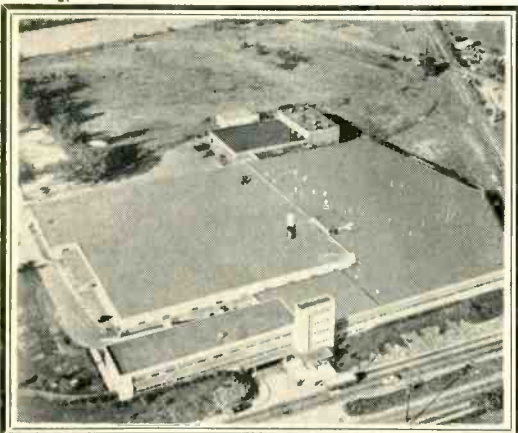

Nashville offers you outstanding cultural and educational opportunities.

ALADDIN ELECTRONICS has all kinds of job opportunities for engineers.

Now is the time to start with an Electronic company that is well financed and solidly expanding — where you won't get penned in a narrow niche or lost in a great big shuffle.

Excellent benefits including Company-paid retirement plan.

Send your resume to:

E. H. Kriel

ALADDIN ELECTRONICS

A DIVISION OF ALADDIN INDUSTRIES INCORPORATED

Nashville, Tennessee

MADIGAN CORP

offers

Excellent Opportunity in

- Research & Development
- Design Engineering
- Production
- Communications
- Field Engineering

Years of experience give us "ADVANCED KNOW-HOW" useful in all phases of the electronic industry

We have a continuing requirement for

- ENGINEERS
- TECHNICIANS &
- DRAFTSMEN

Many field engineering positions both stateside & abroad

Hospitalization for you & family
Life & accident insurance
Regular merit salary review

Inquiries are invited

MADIGAN CORP

526 Mineola Ave., Carle Place, L. I.

**MECHANICAL
DESIGN ENGINEER
PACKAGING**

The opportunity to originate packaging design for advanced radar systems is open to a high-calibre man at this department of a major company.

You will originate and develop designs of mountings and cases for these systems, taking into consideration the practical problems of size, weight, cost and production limitations. Design problems will also include cooling requirements of electronic components and systems, which will be established in consultation with electronic design engineers.

Programming and performance of necessary tests to establish characteristics and suitability of your design models is an important part of this assignment.

Outstanding performance in this position will open the way to senior engineer or specialist status for you here.

Full Fringe Benefits

Location: in upstate New York

Please reply in confidence to:

P-4263, Electronics
Class. Adv. Div., P.O. Box 12,
N. Y. 36, N. Y.

DESIGN AND DEVELOPMENT ENGINEER

Graduate electrical, with knowledge of modern servomechanisms, instrument-minded. Should have studied electronics and have at least five years practical design experience in servomechanisms and related components. Established firm located in Southern New England, manufacturing electrical instrument specialties for 25 years. Pension plan and fringe benefits. Salary open. Submit resume and salary expected.

P-4255—Electronics
Class. Adv. Div., P.O. Box 12, N.Y. 36, N. Y.

CHEMIST

To assume position of Chief Chemist covering the research, development and manufacture of electrolytic and other types of capacitors. Unusual opening for capable theoretical chemist preferably with supervisory experience. This is an unusual opening with a nationally known mid-western capacitor manufacturer. Write in detail covering age, education, experience, etc.

P-4189, Electronics,
520 N. Michigan Ave., Chicago 11, Ill.

PERSONNEL MANAGERS

Looking for Engineers . . . Technicians?



Write
for free
copy of

"RESERVOIR of ENGINEERS and TECHNICAL MEN"

The engineers and technicians you want to reach are gathered in convenient, compact groups—as this 16-page booklet points out.

It keys the job titles these men hold to the McGraw-Hill publications they read for on-the-job information. It explains how you can make contact . . . channel, concentrate your employment advertising to just the men with the job qualifications you want . . . without wasting advertising money for higher-priced space in publications with general circulation, in which you pay for perhaps 999 unqualified readers for every 1 who may meet your job requirements.

Write for your free copy to
Classified Advertising Division
ELECTRONICS

P. O. Box 12, N. Y. 36, N. Y.

Why Not Set Your Sights High?

We Have

AVION

Continues Its Policy of Dynamic Leadership in Electronic Development

IMMEDIATE OPENINGS

FOR OUR PARAMUS, N. J. PLANT:

SENIOR PROJECT ELECTRONIC ENGINEERS

To supervise and coordinate all phases of projects including mechanical design, drafting, manufacturing and final tests.

SENIOR MICROWAVE ENGINEERS

Extensive experience in design of microwave plumbing, cavities, oscillators & antennas.

OPTICAL ENGINEERS

For complex missile guidance optical problems.

PHYSICIST

Experience in semi-conductor or photo conductor research.

FOR OUR ALEXANDRIA, VA. PLANT:

ELECTRONIC ENGINEERS

- (A) Experienced in TV or display circuits R.F. and I.F. amplifiers and digital computer work.
- (B) Experienced subminiaturization magnetic core memories.

- TUITION-PAID EDUCATIONAL PLAN
- IDEAL SUBURBAN LOCATIONS
- TOP RATES

INTERVIEWS IN NEW YORK CITY DURING I.R.E. SHOW

Call: COLfax 1-4100 (Paramus, N. J.)
To Arrange Interview Appointment



SEND RESUME OR CALL

AVION DIVISION

ACF Industries, Inc.

11 PARK PLACE, PARAMUS, N. J.
COLFAX 1-4100
In Virginia: North Pitt St., Alexandria, Va.
King 8-9400

ENGINEER—Filter. Outstanding opportunity for E.E. with thorough knowledge of modern filter theory and design, particularly low frequency and carrier frequency. High frequency and delay line background desirable. Openings exist at both Philadelphia and Los Angeles Plants of our expanding organization. Please write Employment, International Resistance Company, 401 N. Broad Street, Philadelphia 8, Pa.

ELECTRONIC ENGINEERS

Challenging opportunity in Long Island. Excellent salaries, profit sharing, other outstanding benefits.

We need: Engineers, Engineering Aides and Technicians.

Call or write for an interview:

MR. T. VILLA
INSTRUMENTS FOR INDUSTRY, INC.
150 Glen Cove Road • Mineola, N. Y.
Phone Pioneer 2-5300

ENGINEERS ELECTRONIC • MECHANICAL

WE OFFER YOU

*Career openings in
Well-equipped and modern plants
Near centers of higher education doing
Stimulating, interesting work providing
Full rewards for individual initiative in terms of
Professional development and, speaking practically.*

DOLLARS

TAKE YOUR CHOICE:

- Junior to Senior Levels
- Government or Commercial
- Machine Design or Chassis Layout
- Semi-Conductors, Radar & Microwave Techniques

OPPORTUNITIES EXIST FOR:

E.E.'s For circuit design in fields of pulse, radar, microwave on military communications equipment. Salary to \$12,000.

M.E.'s For chassis layout, design of communications equipment, servo design to Government specifications. Salary open.

FULL PARKING AND TRANSPORTATION FACILITIES AVAILABLE

Call or send resume to:

Mr. S. Winston

Radio Receptor Co.

240 Wythe Ave., Bklyn., N. Y. EVERgreen 8-6000

ELECTRONIC ENGINEERS

Openings for men who can offer us light to heavy experience in:

- SERVOMECHANISMS
- FEED BACK TECHNIQUES
- ANALOG COMPUTERS
- SYSTEMS ENGINEERING

With an expanding research and development organization ADMINISTERED AND MANAGED BY ENGINEERS specializing in airborne systems and components offering you:

- CHALLENGING ENGINEERING PROBLEMS
- HIGH SALARIES • 3 MERIT REVIEWS ANNUALLY
- PERMANENT EMPLOYMENT • LIBERAL BENEFITS
- EXCELLENT WORKING CONDITIONS

All replies confidential. Interviews arranged at your convenience.

Phone ST 6-3315 FOR APPOINTMENT OR

SEND COMPLETE RESUME TO PERSONNEL MANAGER

AEROFLEX RESEARCH

INCORPORATED

48-25 36 St., Long Island City 1, New York

Small Company—

BIG OPPORTUNITY

We are looking for two exceptional, qualified ENGINEERS to fill important administrative engineering positions.

Qualifications must include a B.S. in Engineering and proven ability in the supervision of engineering personnel. Ability to coordinate work efforts with the efforts of other groups, departments, companies, and government agencies is essential.

Experience in electro-mechanical, office equipment or photographic fields would be helpful.

Imagination and inventiveness is required, plus the capacity for personal growth in a pioneering organization located in upper New York State.

Please submit resume and salary requirements to:

P4320 Electronics
Class. Adv. Div., P. O. Box 12,
N. Y. 36, N. Y.

ENGINEERS

CGS Labs, performing R and D, and manufacturing specialized products developed by its engineers, seeks engineers with originality, imagination, and thorough understanding of engineering principles. All levels up to Senior Project Engineer, to contribute in communications, magnetic, transistor and tube circuit development, analog and digital computers. Development and design engineering positions.

See examples of our work at booths 1310 and 1312 at the IRE show.

Write for brochure, send resume to:

CGS
LABORATORIES
INC.

391 Ludlow St.,
Stamford, Conn.
DAVIS 4-9508

NEED ENGINEERS?

An employment advertisement in this EMPLOYMENT OPPORTUNITIES section will help you find the engineers you need. It's an inexpensive, time saving method of selecting competent personnel for every engineering job in the electronics field. The selective circulation of ELECTRONICS offers you an opportunity to choose the best qualified men available.

GOODYEAR ATOMIC CORPORATION
ENGINEERS and PHYSICISTS
M.S. - Ph.D.

Several engineers and physicists with extensive background in the fundamentals of analytical and laboratory research and development are needed for activities involving:

- Computers, automatic controls, electromechanical designs.
- Electronic circuit design and analysis.
- Development and application of transistor circuitry.
- Servomechanism and control system analyses.
- Instrument design—electronic and pneumatic.
- Mass spectrometer development.

Send comprehensive resume indicating qualifications, minimum salary requirement and availability for interview. All replies held in strict confidence.

EMPLOYMENT DEPARTMENT B
GOODYEAR ATOMIC CORPORATION
BOX 628, PORTSMOUTH, OHIO

Opportunities in Design & Engineering for

- DESIGN ENGINEERS
- ELECTRICAL ENGINEERS
- PROJECT OR SYSTEMS ENGINEERS
- ELECTRONIC ENGINEERS
- FIELD ENGINEERS

Kollsman's expansion in the airborne equipment field has created openings for additional engineers and electromechanical designers, and offers unusual scope to alert, capable and enthusiastic professional men. For engineers, a degree in Mechanical Engineering, Electronic Engineering or Physics is necessary, plus experience or a strong interest in airborne instrumentation or allied fields.

The congeniality at Kollsman, plus the modern facilities and top professional men provide an atmosphere conducive to creative effort and achievement. Here are designed America's finest aircraft instruments.

Submit resumes to T. A. DeLuca, During I.R.E. Convention in New York, phone Dr. N. Kaplan, NE 9-2900.



kollsman INSTRUMENT CORPORATION

60-86 45th AVENUE, ELMHURST, NEW YORK • SUBSIDIARY OF *Standard* COIL PRODUCTS CO. INC.

WHAT "CAREER OPPORTUNITY"

Means to an Electronic Engineer at General Electric

"CAREER OPPORTUNITY" ...two words you see used everywhere.

WE USE THEM a lot at Electronics Park. But with this difference. To every man who comes to work with us, "career opportunity" has a specific meaning.

And for a very good reason.

ELECTRONICS PARK is where many new concepts in electronics are born. The G-E organization here is primarily in the business of designing and developing new things—components, systems, equipments. Often a whole new product line results from applied research activities here—and after preliminary

production and sales in this area, a new department is organized to handle it—a new plant built in another area—and a new management staff appointed to direct it.

AND MANY of the supervisory and specialist positions in such a new G-E department are drawn from the experienced development staff at Electronics Park.

JOIN US NOW... if you have a BS, MS or PhD degree in Electrical or Mechanical Engineering or Physics AND/OR electronic experience. Send the coupon below... or if you prefer, write us personally in complete confidence.

TO: GENERAL ELECTRIC
 Electronics Pk.,
 Syracuse, N. Y.
 ATT: Dept. 3-7-E
 Technical Personnel

- I am interested in ...
- ... Advanced Development
 - ... Design
 - ... Field Service
 - ... Technical Writing
 - ... Sales

- In the field of ...
- ... Military Radio & Radar
 - ... Multiplex Microwave
 - ... Mobile Communications
 - ... Semiconductors
 - ... Electronic Components
 - ... Computers
 - ... Tubes
 - ... Television Receivers
 - ... Industrial Television
 - ... Antennas

FROM:

NAME _____

ADDRESS _____

DEGREE _____

GENERAL  ELECTRIC

ELECTRONIC ENGINEERS

for component development

- ▶ delay lines
- ▶ shift registers
- ▶ magnetic storage elements

for equipment

- ▶ airborne electronic converters
- ▶ discriminators

for systems

- ▶ analogue and digital conversion links
- ▶ data reduction for process control

YOU might be interested to know that

- Our average management age is under 32.
- At least one new permanent employee joined Epsco each working day in 1956.
- Without exception, our engineers have been given more responsibility at Epsco than in any previous position.
- During the past two years, our engineering team has developed and put into production more than ten commercial products for the data processing field.

If you have ever wanted responsibility and haven't been given a chance, why not contact our Personnel Manager? He would be happy to tell you more about the opportunities for you in our growing company.



588 Commonwealth Avenue, Boston, Massachusetts

DO YOU NEED ENGINEERS WITH EXPERIENCE IN:

- Research
- Development
- Design
- Instrumentation
- Servomechanisms
- Missiles
- Audio Systems
- Control Systems
- Radar
- Computers
- Transistors
- Other Fields

Place an "ENGINEERS WANTED" advertisement in this EMPLOYMENT OPPORTUNITIES SECTION of ELECTRONICS. It's an inexpensive, time saving method of selecting competent personnel for every engineering job in the electronics industry. The selective circulation of ELECTRONICS offers you an opportunity to choose the best qualified men available throughout the industry.

For Rates and Information

Write:

CLASSIFIED ADVERTISING DIVISION

McGRAW-HILL PUBLICATIONS

P. O. Box 12

New York 36, N. Y.

Your Inquiry Will Be Acknowledged!

PHILCO seeks TRANSISTOR SALES ENGINEERS

Ever-increasing demands for Philco germanium and silicon transistors has opened new sales positions throughout the nation.

If you have a technical background and enjoy selling—investigate this ground-floor opportunity.

Unexcelled employee benefits and salary commensurate with background and qualifications.

Local interviews will be arranged for successful candidates. Please submit complete resume in confidence to:

RICHARD ZENDT
PERSONNEL MANAGER
LANSDALE TUBE COMPANY
DIVISION OF PHILCO CORPORATION
LANSDALE, PENNSYLVANIA

Engineers

Who Want to

Be Engineers

... rather than glorified draftsmen,
paper jockeys or rehash artists

Come to Sanders and Go to Work...

... ON ACTUAL, PRACTICAL, THOUGH INTRICATE, OFF-BEAT AND INTRIGU-
ING PROBLEMS IN ADVANCED ELECTRONICS AND ELECTRO-MECHANICS.

Sanders is particularly interested in engineers
versed in:

- hydraulic servo systems, gyroscopes, accelerometers, circuit design & development, magnetic amplifiers, receivers & transistors.
- Men with similar experience, interested in sales engineering, have real opportunity here.
- Also openings for Physicists and Applied Mathematicians.

You'll be working on projects to meet specific customer requirements—not making plans to gather dust in filing cabinets—and you'll be doing it in the company of first rate minds, men who have sparked Sanders' many "firsts"—Panar, Dare pulse doppler radar and seekers, counter-measure systems and special fusings.

This is a company owned by engineers, run for engineers, in the interests of better engineering. If engineering is more to you than a name on an imposing organization chart... if the opportunity to make a genuine contribution to the state of the art ranks higher than a fancy location (though we think ours is pretty nice)... than we'd welcome the opportunity to read your resume. A convenient interview will be arranged. Please address
D. H. Johnson.



ambitious?

**OPPORTUNITIES WHICH
LEAD TO MANAGEMENT**

As an independent leader in the field of high permeability magnetics, we are expanding our creative engineering leadership. These are "threshold to management" positions for which we need

**ELECTRICAL AND
ELECTRONIC ENGINEERS**

Choose your own avenue of development or application work in instrumentation, magnetic circuitry and magnetic materials.

If you can qualify for a really bright future, send experience summary to

Mr. Keith Krewson, Mgr. of Personnel



BUTLER 3, PA.
(near metropolitan Pittsburgh)

*Servo
Engineers*



**ELECTRICAL
MECHANICAL
Inertial
Guidance
System
Program**

Enjoy Challenging Opportunities in the further development and systems testing of Inertial Guidance Systems and their Servo Loops in the most versatile laboratories in the country.

Work with the top men in the field and with the finest test, research and development facilities. New plant being added in suburban Milwaukee as a part of Major, Permanent, Expansion Program.

AC will provide financial assistance towards your Master's Degree. A Graduate Program is available evenings at the University of Wisconsin, Milwaukee.

GM's long-standing policy of decentralization creates individual opportunity and recognition for each Engineer hired.

Milwaukee offers ideal family living combining small town hospitality with every metropolitan shopping and cultural advantage.

For personal, confidential interview in your locality send complete resume to

Mr. Cecil E. Sundeen
Supervisor of Technical Employment



**Recent EE, ME
Graduate
Inquiries
Also Invited**

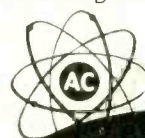

**THE ELECTRONICS DIVISION
GENERAL MOTORS CORPORATION
FLINT 2, MICH. • MILWAUKEE 2, WIS.**

ENGINEERING OPPORTUNITIES

Aircraft Radio Corp., the industry's leader in avionics for over 30 years, has openings on its staff for forward thinking engineers in the following fields:

- TRANSISTOR CIRCUIT PROJECT ENGINEER
- SERVO AND INSTRUMENT ENGINEER
- ENVIRONMENT—TEST ENGINEER
- COMPONENTS ENGINEER
- CHIEF ENGINEER TO HEAD SERVO AND INSTRUMENT DEPT.
- ADVANCED TECHNICIANS

WRITE OR CALL COLLECT: *Personnel Manager*



AIRCRAFT RADIO CORPORATION

BOONTON, NEW JERSEY

Deerfield 4-1800 Ext. 238

#3 of a series

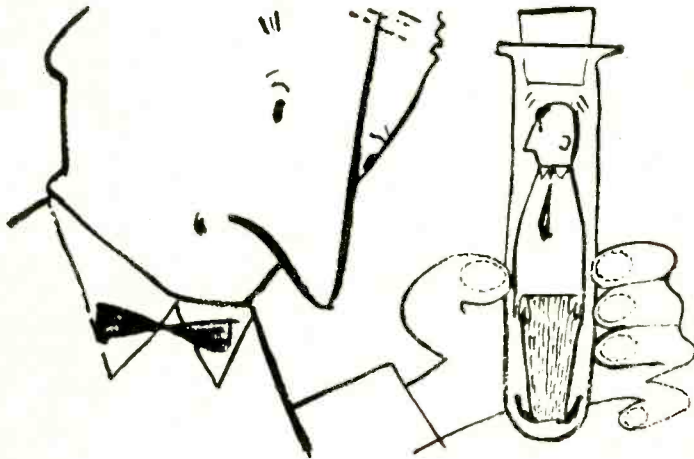

There's a better way to get into research!

TEAM UP WITH ALLIED RESEARCH

We wouldn't recommend the unorthodox means our little peasant-underclass has chosen to get into research. Especially when you can team up with ALLIED RESEARCH where research is both Pure and Unsullied or Applied and Down-to-Earth . . . and Rewarding too. **Write Today** to D. J. Fink.



ALLIED RESEARCH ASSOCIATES, INC.

43 Leon Street Boston, Mass.

Opportunities in these expanding fields: *Aerophysics — Stability and control — Electronics research — Control instrumentation — Computers — Data processing — Airborne systems — Aeroelasticity — Vibration analysis — Nuclear weapons effects — Aircraft and guided missile studies — High energy discharge — Radiation detection*

RESEARCH AND DEVELOPMENT ENGINEERS

Career opportunities in Central Research Laboratory of stable, growing company. Electronic engineers with B.S. or M.S. for advanced circuit design on audio systems, magnetic recording, transistor control circuits for aircraft instrumentation and high frequency instruments. Positions offer opportunity for creative work in stimulating environment. Send resume to: Frank V. Paley, Professional and Technical Employment Manager,

THOMAS A. EDISON, Inc.
WEST ORANGE, N. J.

COMMUNICATIONS ENGINEER

Engineer with degree in communications and 1-3 years experience in telephone industry for interesting position. Will consider 2 or 3 years college with several years experience. Diversified and independent work covering all types of commercial communication systems and apparatus. Location New York. Submit complete application. SEND REPLY TO:

P-4339, Electronics,
Class Adv. Div., P.O. Box 12, New York 36, N. Y.

YOUR ORGANIZATION

Is it complete?

Are you expanding it?

Making Replacements?

Naturally, you are anxious to secure the most suitable man or men available. You want men with the special training that will make them an asset to your organization. You can contact such men through an advertisement in this Employment Opportunities Section of ELECTRONICS.

Classified Advertising Division

ELECTRONICS

P. O. BOX 12

New York 36, N. Y.



ENGINEERS



**OPPORTUNITY... RESPONSIBILITY
... INTELLECTUAL & FINANCIAL
GROWTH? These Become a Reality
with CDC, the Originators of
Compu Dyne Controls.**

• This is an expanding organization of top-flight specialists, who are leaders in the use of the Systems Approach to Test Facility & Industrial Process Control Systems.

• If you are familiar with Basic Instrumentation - Servo Mechanisms - Electronic Systems - Hydraulic Components - Pneumatic Controls - or the Analog Computer, write now for any of the following openings:

- Analytical Eng.
- Project Eng.
- Application Sales Eng.
- Senior Lab Eng.
- Electronic Instrument Development Eng.
- Instrument Field Eng.

FOR NYC INTERVIEW DURING THE
AUTOMATION EXPOSITION,
CALL ENTERPRISE 6065

cdc control services, inc.
400 s. warminster rd. hatboro, pa

ELECTRONIC ENGINEER

Excellent opportunity for circuit design engineer with leading electronic component manufacturer located in New York City.

Experienced with amplifiers, power supplies, test equipment and assist in design of AC & DC circuits.

5 years experience preferred. Degree desirable but not essential.

Pleasant surroundings, congenial atmosphere, company paid health & insurance benefits program. Near all subways.

Submit complete resume including experience, schooling and salary required.

P-4266, Electronics,
Class. Adv. Div., P. O. Box 12,
N. Y. 36, N. Y.

**T. V. ANTENNA ENGINEER
DESIGN AND PRODUCTION ENGINEER
SOUTHEASTERN MASSACHUSETTS
GIVE FULL DETAILS**

P-4233, Electronics,
Class. Adv. Div., P. O. Box 12, N. Y. 36, N. Y.

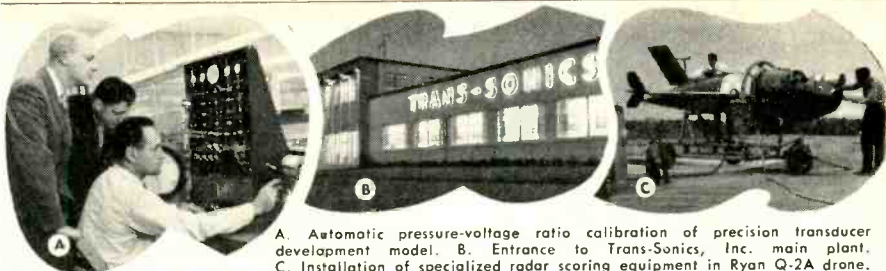

A. Automatic pressure-voltage ratio calibration of precision transducer development model. B. Entrance to Trans-Sonics, Inc. main plant. C. Installation of specialized radar scoring equipment in Ryan Q-2A drone.

Do these pictures fit into your future?

The experience of Trans-Sonics, Inc. in the development of airborne microwave electronic systems and the design and manufacture of precision temperature and pressure transducers has made it one of America's fastest growing electronic firms. The rapid expansion necessary to keep pace with this progress has created a number of long-term opportunities in key engineering positions.

If you are a career-conscious engi-

neer who seeks to improve his future by becoming associated with a company where:—

you will have greater responsibility working with a small, flexible integrated group . . . you will enjoy recognition and promotion that are not tied to seniority

then you should investigate one of the following positions.

RESEARCH & DEVELOPMENT DEPT. AIRBORNE RADAR EQUIPMENT

ELECTRONIC ENGINEER

Overall responsibility
for Field Test Program.

ELECTRONIC DESIGN ENGINEER

Group leader for
advanced designs.

ENGINEERING DEPT.—PRECISION TEMPERATURE & PRESSURE TRANSDUCERS

ELECTRICAL OR MECHANICAL ENGINEER

Technical direction, programming
and supervision of qualification
and environmental tests.

Write to Mr. Elmer G. Guilmartin or
call collect BURLINGTON 7-2011.

Trans-Sonics, Inc.

LEXINGTON 73, MASSACHUSETTS

YOU HAVE THE ENGINEERING ABILITY ...

WE HAVE THE ENGINEERING FUTURE !

Great combination . . . your ability and the opportunities only a pioneer and leader in commercial electronics can offer! Join this team of creative-minded engineers and your ability wins first the recognition and then the responsibility it deserves in a small-group engineering organization.

The future looks practically limitless, speaking from our position today in the vanguard of precedent-shattering electronics developments. Current and appealing openings exist in:

**Data Handling and Computers
Broadcast Equipment**

**Scientific and Industrial Equipment
Sound Products
Communications**

Attractive salaries to start . . . advancement on merit. Liberal company-paid benefits make your future even more secure.

Senior or Junior EE's or ME's . . . men who will accept no measurements for their future except their own achievements . . . you are invited to send a complete resume to

P-4268, Electronics,
Classified Adv. Div., P. O. Box 12, New York 36, N. Y.

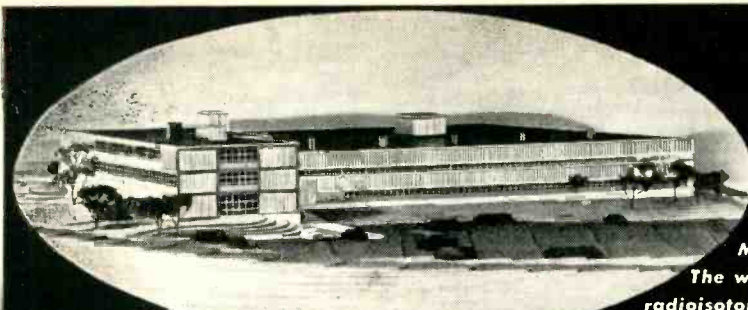

*Tracerlab's
new home
in Waltham,
Massachusetts.
The world's largest
radioisotope laboratory.*

ENGINEERS SCIENTISTS
Not By Chance!

TRACERLAB'S success is not by chance. It is due to people—their spirit, ability and effort. To TRACERLAB people, jobs are not just jobs. There is the satisfaction of being a part of a thriving operation—of contributing personally and seeing tangible results of that contribution. If you are our kind of people, we would like to hear from you.

We have openings in both our new plant at Waltham, Mass. and our Richmond, California laboratories in:

ENGINEERING
Electronic . . . Mechanical . . .
X-Ray

RESEARCH
Nuclear Physics . . .
Solid State Physics
. . . Electronics

During the
National I R E Convention
See or call
our representative
NATHAN BARRY
PLaza 5-0322

Please submit resume
Tracerlab inc.
1601 TRAPELO ROAD,
WALTHAM 54, MASS.

Engineers Needed for Research and Development Positions in the

Design of electronic instrumentation for underwater ordnance, including high gain amplifiers, conventional filters, power amplifiers, oscillators and detectors in the ultrasonic range.

Analytical and experimental treatment of scientific research problems in the fields of hydrodynamics, acoustics, electronics, network theory, servomechanisms, mechanics, information theory and noise analysis including analogue and digital computations.

Design of transducers, fundamental problems in underwater acoustics involving transmission, attenuation, reflection, etc. Problems in sound control and noise reduction. Acoustical aspects of systems research including operations research and feasibility studies.

**EXCELLENT WORKING CONDITIONS
LIBERAL VACATION POLICIES
OPPORTUNITIES FOR GRADUATE STUDY
UNIVERSITY FACULTY APPOINTMENTS**

Send Resume to ARNOLD ADDISON, Personnel Director

**THE PENNSYLVANIA STATE UNIVERSITY
ORDNANCE RESEARCH LABORATORY**

UNIVERSITY PARKPENNSYLVANIA

FOR RATES OR INFORMATION

About Classified Advertising,

Contact
The McGraw-Hill
Office Nearest You.

ATLANTA, 3
1302 Rhodes-Haverty Bldg.
WAlnut 5778
R. POWELL

BOSTON, 16
350 Park Square
HUBbard 2-7160
H. J. SWEGER

CHICAGO, 11
520 No. Michigan Ave.
MOhawk 4-5800
W. HIGGINS
J. BRENNAN

CINCINNATI, 37
1825 Yorktown Road
Swifton Village, Apt. 2
G. MILLER

CLEVELAND, 15
1510 Hanna Bldg.
SUperior 1-7000
W. SULLIVAN

DALLAS, 2
Adolphus Tower Bldg.,
Main & Akard Sts.
Riverside 7-5117
G. JONES

DETROIT, 26
856 Penobscot Bldg.
WOodward 2-1793
W. STONE

LOS ANGELES, 17
1125 W. 6 St.
MAdison 6-9351
C. DYSINGER
D. McMILLAN

NEW YORK, 36
330 West 42 St.
LONgacre 4-3000
S. HENRY
D. COSTER
R. LAWLESS

PHILADELPHIA, 3
17th & Sansom St.
RIttenhouse 6-0670
H. BOZARTH

ST. LOUIS, 8
3615 Olive St.
JEfferson 5-4867
W. HIGGINS

SAN FRANCISCO, 4
68 Post St.
DOuglas 2-4600
R. ALCORN

**ELECTRONICS
ENGINEERS AND TECHNICIANS**

FOR
**GROUND RADIO/RADAR
SYSTEMS**

CONSISTING OF

- Communications
- Computers
- Data Processing
- Radar
- Terminal Equipment

E.E. or equivalent experience required plus 5 years experience in systems engineering or any of the above categories.

IMMEDIATE LONG TERM
FIELD ASSIGNMENTS

SALARY COMMENSURATE WITH BACK-
GROUND PLUS SUBSISTENCE, PAID
TRAVEL EXPENSES. LIBERAL COMPANY
BENEFITS.

Dynamic Electronics

NEW YORK, INC.

73-39 Woodhaven Blvd., Glendale, L. I.
MR. LEONARD ILLINOIS 9-7000

technical representatives

LEAR, INC. is expanding its top notch Field Service organization to keep pace with increasingly widespread military acceptance of LEAR flight control systems and flight reference systems.

Attractive salary, liberal expense arrangements. Assignments may require travel or residence at assigned stations. Company orientation given prior to assignment.

Qualifications include:

1. E. E. Degree or equivalent.
2. Knowledge of servomechanisms, gyros, electronics.
3. Technical Rep. experience.
4. Must be U. S. Citizen.

To apply, send resume to:
Employment Manager

LEAR
INCORPORATED

110 IONIA AVE., N. W.
GRAND RAPIDS 2, MICHIGAN

SALES ENGR. - MGR.

To take charge of sales, sales engineering and advertising for nationally known mid-western capacitor manufacturer. Applicant must have E.E. degree or equivalent in experience and preferably should have held a similar position with a manufacturer of electronic or electrical components. Write in detail covering age, education, experience, etc.

P-4188, Electronics,
520 N. Michigan Ave., Chicago 11, Ill.

ENGINEERS

\$6,000 TO \$30,000

FREE

WORLDWIDE PLACEMENT

Investigate today this free confidential worldwide placement service for graduate engineers & scientists with BS, or MS or PhD. in EE, ME, AeE, ChE, Met.E, Physics and/or mathematics. Let us assist you in selecting from the thousands of positions we have available—the most challenging job opportunity for your career growth.

NO COST OR OBLIGATION TO YOU, NO CONTRACTS TO SIGN

Write us today. To expedite, enclose complete resume including past salaries, indicate specific job interests, and local, national or overseas preference, and salary desired.

HAYNES ASSOCIATES

Executive Engineering Search Office
1346 Connecticut Avenue NW
Washington 6, D. C.

Electronic Engineers

IF YOUR ABILITIES & AMBITIONS ARE STYMIED,
YOUR TIME IS VALUABLE IN RESEARCH AT
CONTINENTAL OIL COMPANY
PONCA CITY, OKLAHOMA

SEND DETAILED RESUMÉ TO PERSONNEL DIVISION

ENGINEERS & PHYSICISTS—

- Getting lost in a large organization?
- Are your engineering talents being wasted?
- Interested in a company owned and operated by engineers?

Expansion of GEL facilities in Cambridge, Mass., and Silver Spring, Md., offers excellent opportunities to individualists who desire professional growth, responsibility, and good salary. Educational programs are available at nearby universities for advanced study.

Positions now open at all levels for electronic and mechanical engineers in the following fields:

- Servos ● Antennas ● Microwaves ● Pulse Circuitry ● Receivers
Countermeasures ● Electronic Packaging ● Pedestal Design

For further information—contact: L. Billig, Chf. Eng.

GENERAL ELECTRONIC LABORATORIES, INC.
18 Ames Street ● Cambridge, Mass.



Why blow your top?

Just shoot us a line if you feel like blasting ahead. We offer real opportunities with individual recognition only possible in a small organization.

Challenging positions open for Physicists, Principal, Senior and Project Engineers in the new field of light intensification, closed circuit TV, X-ray and other related products.

Experience in design of pulse, sweep or video circuitry is preferred.

Newly organized group located in beautiful northern suburb of Baltimore.

Call, wire or write
Mr. R. A. Lee

Bendix - Friez

DIVISION OF BENDIX AVIATION CORP.
TOWSON 4, MARYLAND

Rapid Growth Opportunities in

Semiconductors

ELECTRICAL ENGINEERS . . . PHYSICISTS

. . . who have a B.S., M.S. or Ph.D. degree, above average ability, and are adventurous enough to tackle unusual problems in:

ENGINEERING TRANSISTOR, RECTIFIER and DIODE device definition, evaluation and processing; development and design of automatic controls and automatic test equipment.

AND

RESEARCH in semiconductor solid state physics and electrical chemistry, x-ray crystallography, materials and measurements.

Here is a chance to work with the industry's leading engineers and scientists in a modern, campus-like environment in upstate New York. You will have the advantages of a small company while being backed by tremendous financial resources and complete research facilities.

Enjoy gracious living in the heart of a year-round vacationland.

U.S. CITIZENSHIP NOT REQUIRED

Write in confidence to: P-4244—Electronics
Class. Adv. Div.,
P. O. Box 12, N. Y. 36, N. Y.

VICE PRESIDENT

RESEARCH AND DEVELOPMENT \$20,000
Age 40-50. Background strong in military electronics and contract negotiation. Must have former administrative experience and the ability to correlate the activities of three functions consisting of 300 engineers. Company client assumes all expenses. Your confidence respected.
28 E. Jackson Blvd. Chicago 4, Ill.
MONARCH PERSONNEL

ELECTRONICS ENGINEER

\$14 to \$18,000 Yr.
Well known company seeks Supervisory Engineers with experience in Computer & Analytical devices. Should have Executive ability, & Technical background.
For Confidential & Prompt Service
Send resume to:
J. COOPER
202 S. State—Suite 1116 Phone Harrison 7-6345
Chicago, Illinois

REPLIES (Box No.): Address to office nearest you c/o This publication Classified Adv. Div.
NEW YORK: P. O. Box 12 (36)
CHICAGO: 520 N. Michigan Ave. (11)
SAN FRANCISCO: 68 Post St. (4)
LOS ANGELES: 1125 W. 6th St. (17)

SELLING OPPORTUNITY OFFERED

Opportunity—Manufacturer's Reps. wanted who have following among Electronic Manufacturers to handle profitable line of Nameplates, Dials, and Panels for progressive N. Y. organization. Exclusive territories now open. RW-4186, Electronics.

POSITIONS WANTED

Electronic sales engineer. Heavy diversified component jobber and OEM sales experience. Available for interview at IRE Show. Metropolitan Area preferred. PW-4261, Electronics.

General Manager available soon, due to merger. Experienced in manufacturing, R & D contracts, product evaluation, engineering design and marketing. Heavy electronic background. Prefer Boston area. Reply PW-4176, Electronics.

Electronic & Nucleonics Export Sales Executive seeking position with important Electronics distributor or export sales organization. Age 30, 10 yrs. exp. All phases sales & docs. Presently employed with well known export dept. of N. Y. electronic parts dist. Would consider relocation. PW-4102, Electronics.

SELLING OPPORTUNITIES WANTED

Electronic tubes—Special import and export firm located in West Germany, experienced in East European trade, will sell for you in West and East Germany as well as East and Southern Europe electronic tubes, transistors, diodes. Send your offers to SA-3481, Electronics.

New York—New Jersey engineering representatives long established, now selling over 200 industrial accounts have opening for additional component line, connectors, potentiometers, blowers, motors, servos, resistors, relays, capacitors, printed circuits. RA-4245, Electronics.

QUICK SOLUTION TO MANPOWER PROBLEMS

through the EMPLOYMENT OPPORTUNITIES section of this publication. The market place for those wanting the services of men on engineering, technical and executive level.

The difference between
"making a move"
and getting ahead . . .
. . . IS ABBOTT'S

Let Abbott's act as your agent with the country's outstanding employers of scientific and engineering talent. Capitalize on your maximum abilities with top level remuneration and recognition.

Salaries to \$20,000

- CHIEF ENGINEER**—D&D of float and rate gyros and systems.
- SR. ELECTRONICS ENGINEER**—Circuit design of synthetic display systems. Transistorized digital data processing background required; 8-12 years' experience.
- CHIEF ENGINEER**—D&D of military electronic equipment.
- ELECTRONICS ENGINEER**—For development of digital computer type circuits utilizing transistors.
- MECHANICAL ENGINEER**—For product design packaging and production liaison of racks, cabinets, printed circuits, gear trains and other mechanical components.
- DEVELOPMENT ENGINEERS**—Electronic and computer instrumentation.
- CHIEF PRODUCTION ENGINEER**—Missile systems.

In our 33 years of confidential service, we have become nationally recognized by leading companies as the personnel representative for engineering, scientific and administrative people. Our company clients will assume all expenses. Please send detailed resume to Mr. George R. Sandel, Director. Visit our representative at the Park Sheraton Hotel during the I.R.E. Convention.

ABBOTT'S

EMPLOYMENT SPECIALISTS
333 Washington Street, Boston 8, Mass.

**ELECTRONIC ENGINEERS
PHYSICISTS and related
TECHNICAL PERSONNEL**

B.S. M.S. Ph.D.

Salaries \$5,000 to \$15,000+

Many openings listed here with private industry, universities and government divisions. Apply in person or send resume. No placement fee.

ENGINEERING & SCIENCE UNIT
A highly specialized placement service.

NEW YORK STATE EMPLOYMENT SERVICE
119 Fifth Ave. New York 3, N. Y.

ENGINEERS

If you have been looking for an Employment Agency that is skilled in the STATE OF THE ART of Technical Recruitment and RELIABILITY OF INFORMATION concerning positions, why not communicate with us at once! ALL POSITIONS FEE PAID.

FIDELITY PERSONNEL SERVICE
1218 Chestnut St. Phila. 7, Pa.
Specialists in Aviation and Electronics

PROJECT ENGINEERS \$10-\$12000

Chicago area concern offers excellent opportunities in research, design and development to engineers interested in long range permanent employment. Experience should be in transistors, semi-conductors, instrumentation, electronic equipment or components. Write, Wire or Call—

FRANK CARTER
64 E Jackson Blvd. Chicago, Illinois
Room 940 WAbash 2-1884

**CHIEF ENGINEER
\$12,000**

Nationally known manufacturer of high quality electronic consumer products is expanding its mfg. and engineering facilities. Plant is newly erected and already staffed. Employees number 300. Prefer a young engineer familiar with electrolytic or paper capacitors. Contact—

JOHN BALKANY
6 N. Michigan Ave. Chicago, Illinois
STATE 2-4679

**TEST
ENGINEERS**

**WILL YOU REACH
YOUR MAXIMUM POTENTIAL?**

No matter what your ability, you MUST HAVE the job opportunity and the BEST of TOOLS and FACILITIES to develop your talents to the fullest.

Investigate the Environment created at AC for its Advanced Development Programs on Missile Guidance and Aircraft Fire Control Systems.

OUR ENVIRONMENTAL LABORATORY

is one of the most versatile laboratories in the country and we are in the process of a Major, Permanent Expansion. 225,000 square feet plant being added in suburban Milwaukee.

Our men enjoy working with the finest of test equipment and lab facilities and with the top men in the field.

We are currently engaged in the following types of Test Activities.

- VIBRATION TESTING
- COMPLEX WAVE ANALYSIS
- LOW TEMPERATURE—ALTITUDE
- HIGH TEMPERATURE
- RELIABILITY EVALUATION
- INSTRUMENTATION

Mr. Cecil E. Sundeen, Supervisor of Technical Employment

THE ELECTRONICS DIVISION

GENERAL MOTORS Corporation
FLINT 2, MICH. MILWAUKEE 2, WIS.



ENGINEERS

Reflectone Corporation, established in 1940, is one of the fastest growing organizations in the electronic and electro-mechanical fields.

Situated in the heart of Fairfield County, Connecticut, about 50 minutes from midtown Manhattan. Reflectone offers supervisory positions with high starting salaries and unlimited opportunity for recognition and product development plus all the advantages of life in a fine suburban community with excellent schools, beaches and cultural and educational advantages.

SR. ENGINEER (Electronic)
Project development. 3-5 years exp.

JR. ENGINEERS
Expd. electronic and/or mechanical applications.

CHIEF DRAFTSMAN
Supervise and coordinate efforts of drafting department. Should be expd. in electronic and mechanical designing for production.

TECHNICIANS
Field service. For work on interesting installations throughout the U. S. (Several will be assigned to foreign work)

You are cordially invited to write us about yourself in confidence. We will be glad to send you a brochure telling more about our company.

Mr. Robert Garthwaite

REFLECTONE CORPORATION
Stamford, Conn.
Tel. Flreside 8-4201

**From the desk of
V.P. and General Manager
To Director Engineering Personnel**

Our immediate and future plans in electronics offer top-notch opportunities for Electronic Engineers with the potential to grow with us.

These men will form the nucleus of our newly formed electronic division, and will be working on government and commercial products.

Our record of growth and accomplishment provides a professionally and financially satisfying opportunity to men who have drive, initiative, and ability.

BENRUS WATCH CO.
WATERBURY CONNECTICUT

**The Perfect Climate For
The Young Engineering
Mind to Flourish!**

Live . . .
Work . . .
Play . . .

In this delightful Connecticut community. You're just minutes away from L.I. Sound and its superb boating facilities. Public golf courses, smart shops, modern schools, and comfortable housing accommodations also are available. And, you're only 50 miles from N. Y. City.

ENGINEERS
Mechanical & Electrical

You grow faster . . . go further with a leader. That's why a career with the world's largest producer of X-Ray tubes, and a leader in power broadcast, T.V. and display tube fields, is so coveted. As an important member of our Engineering staff you'll enjoy the full benefits of a dynamic expansion program.

If your background includes experience or familiarity in the field of electronics, you can start planning now on a gratifying future, embellished by an unusually liberal company benefit program, plus a mutually rewarding employer-employee relationship.

Don't let the grass grow under this opportunity. Act now.
Write, drop in or call.

Machlett
Laboratories, Inc.

1063 Hope St., Stamford, Conn.

Fireside 8-7511

**electronic engineer
wanted at B-A**

A position is available in a small research and development electronics group. This work involves transistor circuit and test equipment development as well as general instrumentation problems.

This position offers an opportunity for individual recognition and advancement.

A degree in electrical engineering and two to five years experience in circuit design is required.

Experience in transistor applications is not necessary.

Mr. Carl Richardson will be at our booth #3219, 3221 at the I.R.E. Show in New York. If you wish, you may discuss this position with him during your visit to the show, or you may address your inquiry to the Personnel Director,

Baird-Atomic, Inc.

33 University Rd.,
Cambridge 38, Mass.

All replies will be held in strict confidence.

**SEARCHLIGHT
SECTION**

(Classified Advertising)

BUSINESS OPPORTUNITIES

EQUIPMENT - USED or RESALE

DISPLAYED RATE

The advertising rate is \$21.75 per inch for all advertising appearing on other than a contract basis. Contract rates quoted on request. AN ADVERTISING INCH is measured 7/8 inch vertically on one column, 3 columns—30 inches—to a page.

EQUIPMENT WANTED or FOR SALE ADVERTISEMENTS acceptable only in Displayed Style.

UNDISPLAYED RATE

\$2.40 a line, minimum 3 lines. To figure advance payment count 5 average words as a line.

PROPOSALS, \$2.40 a line an insertion.

BOX NUMBERS count as one line additional in undisplayed ads.

DISCOUNT of 10% if full payment is made in advance for four consecutive insertions of undisplayed ads (not including proposals).

**MANUFACTURERS and/or USERS of
ELECTRONIC EQUIPMENT**

Thousands of financially sound, qualified electronic servicemen and service organizations are desirous of affiliating with manufacturers (who can train them if need be) and then designate them as official factory branch service depots or service representatives. If you are interested in utilizing the services of these capable, experienced technicians on a contract, or otherwise mutually advantageous basis, please advise us of your needs and requirements, and we will forward to you the names and addresses of such individuals and service organizations in any area you specify.

This is a free service of SERVICE DEALER and ELECTRONIC SERVICING. Write "Contact Department."

SERVICE DEALER & ELECTRONIC SERVICING
Cowan Publishing Corp.
300 West 43d St. New York 36, N. Y.

ENGINEERING DEGREES

(Under and Postgraduate)

E. E. Option Electronics
Earned Through Home Study
Residential Courses Also Available

PACIFIC INTERNATIONAL UNIVERSITY

American College of Engineering
Box 27724 Hollywood 27, Calif.

Superior Vacuum Tube Patents

Eleven U. S. Patents for sale or license. Cover superior, practical, standard vacuum tubes for UHF, VHF, FM, TV, Radio, Power, Transmitting, Industrial Applications.

BINNEWEG TELEVISION 5330 College Ave.
Oakland 18, Calif.

FOR SALE

EXCELLENT OPPORTUNITY—WELL ESTABLISHED (EAST) 2-way MOBILE INSTALLATION AND SERVICE BUSINESS—Fully Equipped—7 Vehicles, all Accounts under Contract—Owner Retiring.

BO-4080 Electronics

Class. Adv. Div., P. O. Box 12, NY 36, NY

REPLIES (Box No.): Address to office nearest you c/o This publication Classified Adv. Div.
NEW YORK: P. O. Box 12 (36)
CHICAGO: 520 N. Michigan Ave. (11)
SAN FRANCISCO: 68 Post St. (4)

BUSINESS OPPORTUNITIES

For Sale:—Small Electronics Laboratory in southern Florida:—Specializing in 2-Way FM, High Fidelity and Marine sales & service. Extensively equipped and well stocked laboratory. Enjoy peaceful independence in this well established profitable business. \$35,000. BO-4231, Electronics.

Looking for new fabrication in electronics (transistor) for Europe, no matter if from branch-houses or association. Immediate disposal for terms and study. Write offers to cipher P-1348 N to Publicitas Neuchatel Switzerland.

TUBES

"TAB" TESTED INSPECTED GUARANTEED!!!

"TAB" THAT'S A BUY

Table listing various vacuum tube models and their prices, organized in columns. Includes models like 0A2, 1A4, 6X4, etc., and prices in dollars and cents.

SINCE 1945 CERTIFIED TUBE TESTING AND PRESELECT FACILITIES WRITE!

THAT'S "TAB" THAT'S A BUY

PH. RECTOR 2-6245 CABLE: "TABPARTS"

Dept. 3E7 111 Liberty St., New York 6, N. Y., U. S. A.

Money Back Guarantee (Cost of Mds. Only) \$5 Min. Order FOB N. Y. C. Add shipping charges or for COD 25% Dep. Prices Subject to Change Without Notice.

TUBES

★ Brand New! Guaranteed!
★ Gigantic savings! Act now!
★ Lowest open-market quotes!

BROADCAST TUBES

Table listing various broadcast tubes such as 2H21, 3E29, 4E27, etc. with prices.

5,000 SERIES & UP

Table listing tubes from the 5,000 series and above, including 5517, 5588, 5610, etc.

RECEIVING TUBES

Table listing receiving tubes, including ruggedized (5A4, 6X4, etc.) and non-ruggedized (1A3, 6CL6, etc.) types.

RECTIFIERS & REGULATORS

Table listing rectifier and regulator tubes like OB2, OB3, OC3, etc.

SCOPE TUBES

Table listing scope tubes such as 2A1P, 2B1P, 3A1P, etc.

KLYSTRONS

Table listing klystron tubes like SRX16, 2K25, 2K28, etc.

LIGHTHOUSE TUBES

Table listing lighthouse tubes such as 2C39A, 2C40, 2C42, etc.

TR. AND ATR. TUBES

Table listing triode and atrio-triode tubes like 1B24, 1B35, 1B35A, etc.

DIODES

Table listing diode tubes like 1N21, 1N21C, 1N23B, etc.

COMPUTER TUBES

Table listing computer tubes such as 2G21, 6AN5, 6ANSWA, etc.

JUST RELEASED

Text listing newly released tube types: 1,000, 500, 6130/3C45, 250, 200, 267B, 838W, 272A, 600, 2050W.

WE BUY TUBES... Any size lots... large or small... surplus stocks... contract terminations, etc.

WRITE US TO BUY OR SELL!

FOR RAPID QUOTES:

Phone: REpublic 5-0215
Cable: VHRADLECT
TWX: LA 1460

All items F.O.B. Los Angeles, subject to prior sale and change of price without notice. Write for prices on items not listed.

V & H RADIO and ELECTRONICS

2029-2047 W. VENICE BLVD. LOS ANGELES 6, CALIF.

Large table on the right side listing various electronic components like capacitors (CAN-CAPS), tube sockets (AMPHENOL), plug caps (71-5), motor bases (GE), etc.

DUTCHESS LABS
38 Catskill Ave., Poughkeepsie, N. Y.
Tel Grover 1-2650

SRIR #22 Stranded 1000 volt wire, 75 colors \$2.95 per M, small spools

Precision resistors 1% tol. tubular carbon deposited. Insulated American carbon resistors, all tolerances.

DUMONT HIGH VOLTAGE POWER SUPPLIES



Delivers 23 kv. fully regulated and adjustable. COLOR AND PROJECTION TV. HIGH VOLTAGE TESTING, ETC.

NEW... \$49.95 ea F.O.B. BROOKLYN SEG ELECTRONICS CO., INC. 1778 Flatbush Ave. Brooklyn 10, N. Y.

ELECTRONIC

WAR TERMINATION INVENTORIES

WRITE OR WIRE FOR INFORMATION ON OUR COMPLETE LINE OF SURPLUS ELECTRONIC COMPONENTS. ALL PRICES NET F.O.B. PASADENA, CALIFORNIA



C&H
SALES CO.
2176-E East Colorado St.
Pasadena 8, California
RYan 1-7393

INVERTERS

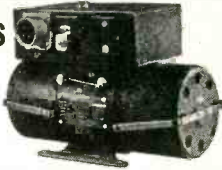

- 10042-1-A Bendix
DC Input 14 volts; output: 115 volts; 400 cycles. 1-phase; 50 watt **\$35.00**
- 12116-2-A Bendix
Output: 115 VAC; 400 cyc; single phase; 45 amp. Input: 24 VDC, 5 amps **\$35.00**
- 12117 Bendix
Output: 26 volts; 400 cycles, 6 volt amperes, 1 phase. Input: 24 VDC; 1 amp. **\$15.00**
- 12121 Bendix
Input: 24 volt D.C. 18 amp. 12000 r.p.m. Output: 115 volts, 400 cycle, 3-phase, 250 volt amp, 7 pf. **\$49.50**
- 12123 Bendix
Output: 115 V; 3 phase; 400 cycle; amps. .5 Input: 24 VDC; 12 amp. **\$49.50**
- 12126-2-A Bendix
Output: 26 volts; 3 phase; 400 cycle; 10 VA; 6 PF. Input: 27.5 volts DC; 1.25 amps. **\$24.50**
- 12130-3-B Bendix
Output: 125.5 VAC; 1.5 amps. 400 cycles single phase, 141 Va. Input: 20-30 VDC. 18-12 amps. Voltage and frequency regulated. **\$49.50**
- 12137 Bendix
Output 250 VA, 115 volts, 3 phase, 400 cycle, 1.25 amp., 0.8 pf. Input 27.5 volt DC, 20 amp. **\$59.50**
- 12142-1-A Bendix
Output: 115 volts, 3 phase, 400 cycle, 250 VA. Input: 27.5 VDC, 22 amps. Voltage and frequency regulated **\$99.50**
- 12147-1 Pioneer
Output: 115 VAC 400 cycles; single phase. Input: 24-30 VDC; 8 amps. **Price \$39.50 each**
- 778 Bendix
Output: 115 volt 400 cycle; 190 VA; single phase and 26 volt, 400 cycle, 60 VA, single phase. Input: 24 VDC. **\$37.50**
- 10285 Leland
Output: 115 volts AC; 750 VA, 3 phase, 400 cycle, .90 pf and 26 volts. 50 VA single phase, 400 cycle, .40 pf. Input: 27.5 VDC 60 amps. cont. duty, 6000 rpm. Voltage and frequency regulated. **\$59.50**
- 10339 Leland
Output: 115 volts; 190 VA; single phase; 400 cycle, .90 pf and 26 volts; 60 VA; 400 cycle, .40 pf. Input: 27.5 volts DC, 18 amps. cont. duty, voltage and freq. regulated. **\$49.50**
- 10486 Leland
Output: 115 VAC; 400 cycles; 3-phase; 175 VA; .80 pf. Input: 27.5 DC; 12.5 amps.; cont. duty. **\$70.00**
- 10563 Leland
Output: 115 VAC; 400 cycle; 3-phase; 115 VA; 75 pf. Input: 28.5 VAC; 12 amps. **\$35.00**
- PE109 Leland
Output: 115 VAC, 400 cyc.; single phase, 1.53 amp.; 8000 rpm. Input: 13.5 VDC; 29 amp. **\$50.00**
- PE218 Leland
Output: 115 VAC; single phase pf. 90; 380/500 cycle; 1500 VA. Input: 25-28 VDC; 92 amps.; 8000 rpms.; Exc. Volts 27.5. BRAND NEW **\$30.00**
- MG149F Holtzer-Cabot
Output: 26 VAC @ 250 VA; 115 V. @ 500 VA; single phase; 400 cycle. Input: 24 VDC @ 36 amps. **\$40.00**
- MG153 Holtzer-Cabot
Input: 24 VDC; 52 amps. Output: 115 volts — 400 cycles, 3-phase, 750 VA. Voltage and frequency regulated. **\$95.00**
- DMF2506M Continental Electric
24-30 volts input; 5.5-45 amps.; cont. duty. Output: 115 volts; .44 amps.; 400 cyc.; 1 phase; pf. 1.0; 50 watts **\$39.50**
- AN 3499 Eicor, Class "A"
Input: 27.5 volts at 9.2 amps. AC. Output: 115 volts 400 cycles; 3 phase 100 voltamp; continuous duty. **Price \$39.50 each**

VARIABLE SPEED BALL DISC INTEGRATORS

Forward & Reverse 4-0-4. Input shaft 5/16" dia. x 3/4" long. Output shaft 15/64" dia. x 9/16" long. Control shaft 11/64" dia. x 11/16" long. Cast aluminum construction approx. size 4 1/2" x 4 1/2" x 4".



No. 146
\$17.50 ea.

Forward & Reverse 2 1/4-0-2 1/4. Input shaft spline gear 12 teeth 9/32" dia. 3/8" long. Output shaft 15/64" dia. x 15/32" long. Control shaft 11/32" x 3/8" long. Cast aluminum construction. Approx. size 3" x 3" x 2 3/4".



No. 145
\$17.50 ea.

(All Shafts on Both Ball Bearing Supported)

SELSYNS-SYNCHROS



- 1CT Cont. Trans. 90/55V 60 cy. **\$37.50**
- 1DG Diff. Gen. 90/90V 60 cy. **37.50**
- 1F Syn. Mtr. 115/90V 60 cy. **37.50**
- 1G Gen. 115V 60 cy. **12.50**
- 1SF Syn. Mtr. 115/90V 400 cy. **7.50**
- 211F1 Gen. 115/57.5V 400 cy. **10.00**
- 211F3 Gen. 115/57.5V 400 cy. **7.50**
- 211FA1 Gen. 115/57.5V 400 cy. **5.00**
- 211G1 57.5/57.5V 400 cy. **7.50**
- 211H1 Diff. Gen. 57.5V 400 cy. **17.50**
- 215D1 Cont. Trans. 105/55V 60 cy. **17.50**
- 215F1 Cont. Trans. 105/55V 60 cy. **17.50**
- 215H1 Gen. 115/105V 60 cy. **17.50**
- 2115M1 Gen. 115/57.5V 400 cy. **34.50**
- 5CT Cont. Trans. 90/55V 60 cy. **34.50**
- 5D D.F. Mtr. 90/90V 60 cy. **34.50**
- 50DG Diff. Gen. 90/90V 60 cy. **34.50**
- 5F Syn. Mtr. 115/90VAC 60 cy. **42.50**
- 5G Syn. Gen. 115/90VAC 60 cy. **12.50**
- 5HCT Cont. Trans. 90/55V 60 cy. **25.00**
- 5SDG Diff. Gen. 90/90V 400 cy. **34.50**
- 6DG Diff. Gen. 90/90V 60 cy. **42.50**
- 6G Syn. Gen. 115/90VAC 60 cy. **17.50**
- 7G Syn. Gen. 115/90VAC 60 cy. **15.00**
- R110-2A Kearfott Cont. Mtr. 115V 400 cy. **20.00**
- R200-1-A Kearfott Cont. Trans. 26/11.8V 400 cy. **20.00**
- R210-1-A Kearfott Trans. 26/11.8V 400 cy. **20.00**
- R220-T-A Kearfott Receiver 26/11.8V 400 cy. **22.50**
- R235-1A Kearfott Resolver 26/11.8V 400 cy. **20.00**
- C56701 Type 11-4 Rep. 115V 60 cy. **20.00**
- C69405-2 Type 1-1 Transm. 115V 60 cy. **20.00**
- C69406 Syn. Transm. 115V 60 cy. **20.00**
- C69406-1 Type 11-2 Rep. 115V 60 cy. **10.00**
- C76166 Volt. Rec. 115V 60 cy. **12.50**
- C78248 Syn. Transm. 115V 60 cy. **5.00**
- C78249 Syn. Diff. 115V 60 cy. **7.50**
- C78863 Repeater 115V 60 cy. **20.00**
- C79331 Transm. Type 1-4 115V 60 cy. **7.50**
- 851 Bendix Autosyn Mtr. 22V 60 cy. **7.50**
- 403 Kollsman Autosyn. Mtr. 32V 60 cy. **19.50**
- FPE-25-11 Diehl Servo Mfr. 75/115V 60 cy. **25.00**
- FPE-43-1 Resolver 400 cy. **19.50**
- FJE-43-9 Resolver 115V 400 cy. **15.00**
- 999-C411 Kollsman 26V 400 cy. **10.00**
- 13770410 Kollsman 26V 400 cy. **20.00**
- 1515B-0410 Kollsman 26V 400 cy. **12.50**
- 10047-2-A Bendix 26V 400 cy. **15.00**
- 2900 Transicoid 115V 400 cy. **15.00 ea.**
- 15CX4a Synchro Transmitter MK 22 MOD 1

SIMPLE DIFFERENTIAL



Size: 2-5/32" long x 1 1/4" dia.; bearing one end 1/2" O.D.; Shaft Size: 1" long, threads 8-32-3/4" long, with bearing shaft 1/8" dia. x 1/4" long. Gear on shaft end 1-7/16" dia., gear on bearing end, 1 1/4" dia. Drive gear 25/32" dia.

Stock No. 101

\$3.95 ea.

SIMPLE DIFFERENTIAL



1:1 reverse ratio, 60 teeth on large gear; 1/4" shaft. Size: 3" long with 1-15/16" dia.

Stock No. 106

\$3.95 ea.

DIFFERENTIAL



Size 2-11/16" long 1-11/16" dia. 1:1 reverse ratio. 1/4" shaft on each end; one shaft 25/32" long, one shaft 15/32" long. Input and output gear 15/16" dia. 60 teeth.

Stock No. 148

\$3.30 ea.

Dual Simple Differential

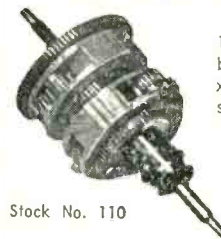

1:1 reverse ratio or both. Size: 3 1/4" long x 1-7/16" dia. Shaft size 1/8" and 5/32".

Stock No. 110

\$7.50 ea.

SMALL DC MOTORS



- (approx. size overall 3/4" x 1 1/4" dia.)
- 5067126 Delco PM, 27 VDC, 125 RPM, Governor Controlled **\$15.00 ea.**
- 5069600 Delco PA1 27.5 VDC 250 rpm **12.50**
- 5069230 Delco PA1 27.5 VDC 145 rpm **15.00**
- 5068750 Delco 27.5 VDC 160 rpm w. brake **6.50**
- 5068571 Delco PM, 27.5 VDC 10,000 rpm (1x1x2") **5.00**
- 5069625 Delco 27.5 VDC 120 rpm w/governor **15.00**
- 5069790 Delco PM, 27 VDC, 100 RPM, Governor Controlled **15.00 ea.**
- 5BA10A118 GE 24 VDC 110 rpm **10.00**
- 5BA10AJ37 GE 27 VDC 250 rpm reversible **10.00**
- 5BA10AJ52 27 VDC 145 rpm reversible **12.50**
- 5BA10AJ50, G.E., 12 VDC, 140 R.P.M., 206-1001 PM Planetary Gear Reduced Motor with Magnetic Brake. Mfgd. by Air Equipment 26 volts 600 ma 145 rpm **17.50**
- 5BA10FJ33, G.E., 12 VDC, 56 R.P.M., reversible **15.00**
- 806069 Oster series reversible 1/50 h.p. 10,000 rpm 27.5 VDC 1 5/8" x 3 1/2" **5.00**
- C-28P-1A 27 VDC 1/100 h.p. 7,000 rpm **3.00**
- 7100-B-PM Hansen 24 VDC 160 rpm **7.50**
- SSFD-6-1 Diehl PM 27.5 VDC 10,000 rpm **4.00**

BIG THINGS ARE HAPPENING at Universal YOUR RELAY HEADQUARTERS!

• **NEW NAME! UNIVERSAL RELAY CORPORATION**

Formerly Universal General Corporation

• **NEW ADDRESS!** 42 WHITE STREET, NEW YORK 13, N. Y.
3 blocks south of former location—324 Canal St.

We have consolidated the
LARGEST STOCK OF RELAYS IN THE WORLD
in one large building with **BETTER QUARTERS** and **MORE FACILITIES** for **BETTER SERVICE**

SEND FOR OUR LATEST CIRCULARS



SS5

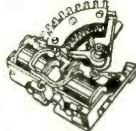

Mfd. by Western Electric; Minor Switch 10 steps and off. Contacts: Nos. R960, 975, 976 Gold plated brass; Bridging wiper; Nos. R977, 978, 979 beryllium-copper, Nonbridging wiper; Net Wt. 1 lb.

Volts DC	1 level		2 level		3 level	
	Stk.#	Price*	Stk.#	Price*	Stk.#	Price*
6- 12	R960	9.50	R977	10.50	R642	11.50
24- 36	R975	10.50	R978	11.50	R600	12.50
48- 60	R976	11.50	R979	12.50	R645	13.50
100-125	R643	12.50	R644	13.50	R646	14.50

SS6

Mfd. by Western Electric Co.; 22 step; 5 levels; Bridging wipers; Contacts; Gold plated brass. Interrupter Switch: 1 Break-Make; Net Weight: 2 lb. 2 oz. "Homing" type; 180° Wipers; Step in One Direction.

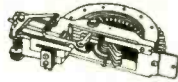

#R926; 6 to 12 VDC	13.75	#R981; 48 to 60 VDC	15.75
#R980; 24 to 36 VDC	14.75	#R615; 100 to 125 VDC	16.75

SS7

Mfd. by Western Electric Co.; 44 step; 2 levels Bridging Wipers; Contacts: Gold plated brass; Interrupter Switch: 1 Break-Make; Net Weight: 1 lb. 14 oz. "Homing" Type; 360° Wipers; Step in One Direction.

#R927; 6 to 12 VDC	13.75	#R983; 48 to 60 VDC	15.75
#R982; 24 to 36 VDC	14.75	#R616; 100 to 125 VDC	16.75

Prices listed with asterisk (*) are subject to QUANTITY DISCOUNTS

ALL MERCHANDISE IS GUARANTEED AND MAY BE RETURNED FOR FULL CREDIT

1-9	as quoted	50-99	15%
10-49	10%	over 100	20%

BC-1060A OSCILLOSCOPE

A limited number of these extra fine general purpose oscilloscopes are available from a recent production. The specifications are as follows:

The vertical response is within 3 db from 20 cycles to 20 megacycles. The horizontal response within 3 db from 10 cycles to 100 kc and the "Z-axis" response within 3 db from 30 cycles to 3 megacycles. Deflection sensitivity .1 volt rms per inch deflection. The horizontal sensitivity .9 volts rms per inch deflection. The "Z-axis" sensitivity 15 volts peak signal is enough to bring the beam from just being extinguished to normal brilliance. The instrument operates from 105 to 125 volts, 50-60 cycle source and consumes 150 watts. Physically the instrument is 16" in overall height, 17" in overall depth and 10½" in overall width. Weight: 60 lbs. Available complete with instruction book.

TS-89 VOLTAGE DIVIDER

Of new production, the TS-89 Voltage Divider provides a means of measuring high impedance pulses normally included in radar and ranging between 200 to 20,000 normally included in radar and weighing just under 4 lbs. this instrument is available from new production at\$45.00 each.

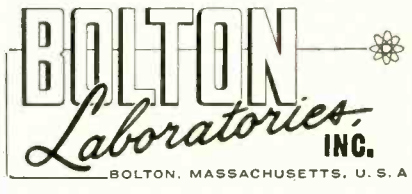

SYNCHROS

AC Motor and Generator
Bendix 115 V. 60 Cycle Type XV
Price per pair, Used Units \$2.79

SANFORD ESTES & COMPANY
Electrical Division

4548 Cottage Grove Ave. Chicago 15, Ill.

LOOK HERE!

LAD Signal Gen. 2700-2900 Mc. Sim. to TS-14. For SP or SP-1M Radar..\$95.00
G. R. Variac, Type 60 AUS-1 400 Cy. 12.00
HICKOK MOD.-59 400 Cy. Freq. Ind. meter, 350-450 Cy. 90-140 V.. 19.00
B. C.-375 Transmitter with five TU's and Ant. tuner..... 65.00
RBL-5 Regen. Receiver 15-600 KC... 65.00
Powerstat 115V-15 Amp. 60 Cy.... 29.00
Powerstat 230V- 9 Amp. 60 Cy.... 29.00
TBW-RBM gas generator 120 V. 1 phase 800 Cy. 1.18 KVA..... 125.00
LM Type Freq. meter with book.... 75.00
L&N Hoops Conductivity bridge.... 150.00
G. R. 733-A 400 Cy. Oscillator..... 45.00
Measurements Corp. Mod. 62 V.T.V.M. 60.00
L&N Mod. 4282 Ohmeter..... 60.00
G. R. Mod. 726-A V.T.V.M..... 50.00
L&N Mod. 5300 Wheatstone Bridge.. 85.00
Freq. time counter, Potter Mod. 801.150.00
Measurements Corp. Mod. 78-B Sig. Gen. 50.00
Top seven items new; others in good cond.

ALGERADIO ELECTRONICS CO.
236 N. Franklin St., Hempstead, N. Y.

Ask for
Mr. Herzog
or
Mr. Greenberg

Universal RELAY CORP.
Formerly Universal General Corp.
42 WHITE ST., NEW YORK 13, N. Y. • WALKER 5-9642

CONSISTENTLY HIGH QUALITY
ELECTRON TUBES
AT SENSIBLE PRICES!
Largest stock in the country.
• ALSO •
Large diversified selection of
TEST & COMMUNICATIONS EQUIP.
WRITE
For latest comprehensive catalog and tube price sheet
BARRY ELECTRONICS CORP.
512 Broadway, N. Y. 12, WALKER 5-7000
TWX: N. Y. 1-3731

TRANSFORMERS—CHOKES—ETC.
AUTOTRANS .85KVA 50/60C. 189/208/226/100V..... \$9.95
PLATE TR. RAYTH. PRI 145V 60C./6180V @ 157Ma..... 9.95
" 115/230V 60C./1125V @ 7A.D.C. P/O BG 448..... 24.95
" 115V/1080 V.C.T. @ 650Ma Cased..... 12.95
FIL. TR. 110/120/125V.-21/2V. @ 15A; 21/2V. @ 15A..... 3.25
" 100/1-0/120V; 10V/4 1/2A. 10V/4 1/2A. 10V/3 1/4A (All C.T.) 6.3V/1A..... 3.50
" 115V/60C. 5V/7 1/2A C.T. 5V7 1/2A C.T. 5V/7 1/2A C.T. HV. INSUL..... 2.95
" 110/115/120 50/60C. 10V/5A C.T. 10V/10A C.T. THORD..... 3.50
POWER TR. FREED 600C.T./150 Ma, 5V/3A, 6.3V/3A..... 3.25
" 120V 50-60C./1700V C.T./150Ma., 6.3V 5A, 6.3V/3A, 5V/3A..... 4.25
SPECIALS Altec Lansing TMS 217A 3000~ 250/500~..... 3.50
HVY CHOKE 8 Henry/.98A, 24 ohm 5KV INSUL..... 14.95
HYDROPHONE—Complete Undersea Mike & FM XMT..... 10.95
DISCONE ANTENNA High Gain 300-3000MC P/O Apr-4/AT49A..... 4.95
Also: Relays, Oils, Micacs, Res. Send Requirements
RADIONIC PROD CO. 325 Canal St., N.Y. 13, N.Y.

COMMUNICATIONS EQUIPMENT CO.

TIC SIGNAL GENERATOR

The type 1900 Multi-Frequency Generator is a 10 frequency, 400 cps modulated, crystal controlled oscillator intended for the preliminary alignment of stagger tuned IF amplifiers of television receivers. Crystals ranging from 17 to 40 mc can be provided to exact frequencies specified. Crystals are arranged in sequence. The frequency accuracy is better than .05% and the modulation is adjustable from zero to approximately 30% by an internal control. Frequency selection is instantly accomplished by means of a special coin silver contact rotary switch actuated by a heavy duty pulsing solenoid and front panel push button selector switch. The output signal is 0.5 volts across a 75 ohm terminated output cable 4 feet long. The output signal is capable of attenuation over a range of 1000 to 1. The power supply is electronically regulated to assure complete freedom from line voltage fluctuations from 105 to 125 volts.

The instrument is contained in a grey wrinkle finished cabinet 12 1/2" wide, 9 1/2" deep, and 8" high. Shielding is adequate to prevent excessive radiation. All units are supplied with a minimum of five crystals as follows: 25 mc, 22.75/45.5/41.2, and 32.50/45 mc. Used, excellent. **\$32.50**

PULSE TRANSFORMERS



352-7150. Primary 50 ohms. Secondary 1000 ohms. 12,000V. 12 Amp. Pulse: 1 or 2 usec. at 001 duty ratio. Fitted with magnetron well and bifilar winding for filament supply. **\$32.50**

MAGNETRON PULSE TRANS. #964: Prim. Imp. 50 ohms. 1000 v. pulse. Secondary Imp. is 1250 ohms. 12 KV pulse. Turns ratio sec:pri. is 7.5:1. Duty ratio is 0.001 at 1.2 usec. Bifilar winding 1.2A. **\$8.50**
RAYTHEON WX 4298E: Primary 4KV., 1.0 USEC. SEC. 16K-16 AMP DUTY RATIO: 001 400 CYCLE FIL. TRANS. "BUILT-IN" **\$22.50**
GE #K-2448-A: Primary: 9.33 KV, 50 ohms Imp. Secondary: 28 KV, 350 ohms. Pulse length: .05/5 usec @635/120 PPS. PK Power Out: 1.740 KW. Bifilar: 1.5 amps. **\$62.50**
GE #K-2748-A: 0.5 usec @ 2000 Pps. Pwr. out is 32 KV impedance 40:100 ohm output. Pri. volts 2.3 KV Pk. Sec. volts 11.5 KV Pk Bifilar: rated at 1.3 Amp. Fitted with magnetron well. **\$24.50**
K-2745: Primary: 3.8 KV, 50 ohms. Secondary: 14/12.6 KV 1025 ohms Z. Pulse length: 1/50 usec @ 600-600 PPS. PK. Power 200/150 KW. Bifilar: 1.3 Amp. Has "built-in" magnetron well. **\$32.50**

9000 MC RF PACKAGE

A Set of four major components to form a 35 KW (peak) RF head operating in the range of 9345-9405 mc, consisting of the following:
 (1) Pulse-forming network, 30 ohms imp, 2 usec (at 350 pps)/0.6 usec (at 2000 cps)
 (2) Pulse transformer to match 30 ohms to 1250 ohms. Primary 1.6 KV, Secondary 12 KV. Bifilar Winding: 1.2 A.
 (3) Magnetron, type 725A (Fits into magnetron well on Transformer)
 (4) Magnet for 725-A (1,850 Gauss)
 Complete Package, with Schematic diagram **\$35.00**

SYNCHROSCOPE/TS 28/UPM

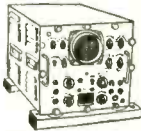

This unit is an instrument originally designed for testing beacon and radar sets, but may be used for general laboratory work. The scope is equipped with a type 50P1 CRT tube and uses triggered sweeps running from 1 to 6 usec/inch. Free-running sawtooth rates are 20 to 3000 cps. Positive and negative output triggers having rep rates of 330/500/1,000/2000 and 3000 cps are supplied. Marker periods are 2/10' and 25 usec accurate to 1%. The 2-stage video amplifier has a bandwidth of 5 mc and a gain of 100. Used, in excellent condition. **\$175.**

DYNAMOTORS

TYPE	INPUT VOLTS	AMPS	OUTPUT VOLTS	AMPS	Price
BOAR83	14		375	.150	\$6.50
POSX-15	14	2.8	270	.08	8.95
DM33A	28	7	540	.250	3.95
B-19	12	9.4	275	.110	6.95
			500	.050	
OA-3A*	28	10	300	.260	3.95
			150	.010	
			14.5	5.	
PE 73 CM	28	19	1000		10.50
BD 60	14	2.8	220	.68	8.95
DAG-33A	18	3.2	450	.06	2.50
BOAR93	28	3.25	375	.150	6.95
					Replacement for PE 94.
					1 Less Filter
PE 94—Brand New					5.95

MICROWAVE COMPONENTS

10 CM.—RG48/U Waveguide

POWER SPLITTER for use with type 726 or any 10 CM. Shepherd Klystron. Energy is fed from Klystron antenna through dual pick-up system to 2 type "N" connectors **\$12.50**
LHTR. LIGHTHOUSE ASSEMBLY: Parts of RT39 APG 5 & APG 15, Receiver and Trans. Cavities w/ assoc. Tr. Cavity and Type N C/P.L.G. To Recv. Uses 2C40, 2C43, 1B27, Tunable APX 2400-2700 MCS. Silver Plated Feed. **\$15.00**
BEACON LIGHTHOUSE cavity 1/0 UPN-2 Beacon 10 cm. Mig. Bernard Rice, each **\$27.50**
MAGNETRON TO WAVEGUIDE Coupler with 721-A Duplexer Cavity, gold plated. **\$31.50**
721A TR BOX complete with tube and tuning plungers **\$12.50**
MCNALLY KLYSTRON CAVITIES for 707B or 2K28, 2700-2900 MC **\$4.00**
HOLMDELL-TO-TYPE "N" Male Adapters. W. E. #D167284 **\$2.75**
BEACON ANTENNA AS31/APN-7 in Lucite Ball. Type "N" feed. **\$22.50**
ANTENNA, AT-49A/APR; Broadband Conical, 300-3300 MC Type "N" feed. **\$8.50**
"E" PLANE BENDS, 90 deg. less flanges. **\$12.50**
K-Band, X-Band Eqpt. Available. Send for List

X BAND - 1" x 1/2" WAVEGUIDE

90 degree elbows. "E" or "H" Plane 2 1/2" radius **\$8.50**
AT-68/UP 3 Cm Horn with type N feed for receiver measurements, etc. New **\$7.45**
ROTARY JOINT (APS-6) Sperry PT #658275, 180 deg. rotation, choke to choke. Has "Built-in" Di-Coupler, 20 DB, with "N" Takeoff. **\$22.50**
PARABOLOID DISH, 18" diam Spin Aluminum, 8" Focus. For AN/APS-6. **\$4.95**
3 CM. DIPOLE and Feed Assembly. (May be used with above dish.) 8 inches long. **\$5.00**
FLEXIBLE SECTION 9 in. long. Cover-to-Cover **\$5.50**
ROTARY JOINT (APS-6) Sperry PT #658275, 180 deg. rotation, choke-to-choke. Has "Built-in" Di-Coupler, 20 DB, with "N" Takeoff. **\$22.50**
3 CM. DIPOLE FEED, 10 1/2" Focus. **\$14.50**
3 CM. ANTENNA ASSEMBLY: Uses 17" paraboloid dish, operating from 24 vdc motor. Beam pattern: 5 deg. in both Azimuth and elevation. **\$35.00**
30" PARABOLIC DISH, aluminum Focus 10 1/2". **\$4.85**

INVERTERS

PE-218H: Input: 25/38 vdc, 92 amp. Output 115V 300/500 cy. 1500 Volt-ampere. NEW **\$32.50**
EICOR—ML 3011-5: Input: 13.75 V; 18-1A; Output: 115V/400—, 3ϕ, 0.95 PF. 100 VA. New. **\$59**

343 Canal St., New York 13, N.Y. Dept. E-3 Chas. Rosen Phone: Canal 6-4882

MINIATURE BLOWERS:

MOTOR and BLOWER—
DELCO 5068571—27 VDC Reversible PM Motor, 6000 RPM, with Blower. Overall size, including Blower: 2 1/2" x 2 1/4" x 3". Wt. 9 oz. As pic. **\$4.50**
DELCO 5069267—27 VDC, 6000 RPM, 1.5 oz. in torque. Reversible S h u n t Motor, Flang Mounted. Size: 2 1/2" x 2 1/4" L. Flange: 2 1/4" D. Shaft: 1/8" Dia. **\$2.95**
24 VOLT 10 CFM BLOWER—Housed in a cast aluminum case. Shunt Type Motor 24 VDC @ 6 A. 5000 RPM with motor noise Filter. Size: 3 1/4" x 4 1/4" L x 4 1/4" H. Wt. 1 lb. 10 oz. No. **\$5.95**
SS2345
115 VAC 400 CY. 10 CFM BLOWER—7200 RPM 1/100 HP. Bakelite blower Housing. Overall size: 3 1/2" x 3 1/4" x 4 1/4". Wt. 1 lb. 7 oz. East— **\$5.95**
ern Air Devices No. 331A
10 CFM BLOWER—OSER MOTOR C2BP-1A—27.5 VDC 1/100 HP. 7000 RPM. Bakelite Blower. Housing. Overall size: 3 1/4" x 3 1/4" x 4 1/4". Wt. 1 lb. 4 oz. Price **\$5.95**

New List— Just Out—Including many other Motors, Blowers, Dynamotors, etc. Free—Write for copy today!

115 V. 60 CYCLE BLOWERS:

At Left: 115 VAC 60 Cycle SINGLE TYPE—100 CFM— 2 1/4" intake; 2" outlet. Complete size: 5" x 6" — **\$9.95**
No. 1C880
15 VAC 60 Cycle DUAL TYPE— 100 CFM—4" intake; 2" Dis. Each Side. Complete size: 8" x 6" **\$14.95**
No. 1C880
115 VAC 60 cycle COMPACT TYPE—108 CFM— Motor built inside squirrel cage; 4 1/4" intake; 3 3/4" x 3" Dis. Complete size 4 1/4" W x 8 3/8" H x 3 3/4" D— **\$15.95**
8 1/4" D—No. 2C067
115 VAC 60 cycle FLANGE TYPE—140 CFM; 3 1/4" intake; 2 1/2" Dis. Complete size: 7 1/2" x 7 1/4" W x 8 3/4" H x 6 3/4" D. No. 1C807 **\$14.95**
115 VAC 60 cycle FLANGE TWIN—275 CFM; 4 1/4" intake; 3 1/4" x 3" Dis. Complete size: 11 3/4" W x 2 3/4" H x 8 1/16" D— **\$22.95**
No. 2C069

DYNAMOTORS

INPUT VOLTS	OUTPUT VOLTS	MA	STOCK No.	PRICES USED NEW
12 VDC	220	80	DM-34	\$2.95 \$4.95
12	625	225	DM-35	9.95
12	230	90	PE-133	4.95 6.95
12 or 24	540	450	DA-12	14.95
12 or 24	230	100	DA-14	8.95
14	220	70	DM-24	4.95 7.95

FAIR RADIO SALES • 132 SOUTH MAIN ST. LIMA, OHIO

CONSISTENTLY HIGH QUALITY ELECTRON TUBES

AT SENSIBLE PRICES!
 Largest stock in the country.
 • ALSO •
 Large diversified selection of

TEST & COMMUNICATIONS EQUIP.

WRITE

For latest comprehensive catalog and tube price sheet

BARRY ELECTRONICS CORP.

512 Broadway, N. Y. 12, Walker 5-7000 TWX: N. Y. 1-3731

UNIVERSAL CONSOLE

Flexible—accommodates any standard RMA 19" rack mounted unit. The same unit may be installed in cabinets or consoles permitting flexibility in expansion or re-arrangement.
 The universal console is designed for operator comfort, viewing ease and maximum accessibility to all controls and chassis.
 Two, three or more universal consoles may be ganged together. Thereby utilizing a minimum of space. Dimensions—Max. height: 57". Width: 19 1/2" without end bells. 27 1/8" with end bells. Distance floor to shelf: 27 3/4". Max. depth: 37 1/2". Weight: 150 lbs. approx. with end bells and shelf.

COMPLETE UNIT **\$59.50** while they last—

RED ARROW ELECTRONIC SALES CO.

12-17 Summit Ave. Union City, N. J.

COMMUNICATIONS & TEST EQUIPMENT

Top quality communications and test equipment at low prices.

Here are a few leaders

BC-375—Complete two cases, export, packed, unused ground transmitting equipment.

AN/ARN-6 & -14—Radio compass equipment.

ART-13—Transmitter 100 W Airborne or ground.

AN/APR-4—Laboratory receiver with tuning units.

TS-147D/UP—X band test equipment Signal generators.

TS-323/UR—Frequency meter.

334-E—Control box.

R-252/ARN-14 Receivers

R-122-A/ARN-12 Marker Beacon

TS-125/AP Test Equipment

TS-186/UP Test Equipment

Prices on request only
 Immediate Delivery

We buy clean communications and test equipment unmodified. Top prices.

MONTGOMERY EQUIPMENT CO.

14315 Bessemer St.

Van Nuys, California

Telephone: STate 6-4657

Telegraph Station YHV

Cable Address MONTEQUIP

CONDENSERS

4 mfd.—600 V \$.95

Inverted cylindrical cap. single term. Mount through 3/4" hole in chassis. Hardware included. Factory cartons. Qua. disc.

16 mfd.—600 V \$ 1.89

Dual 8 mfd oil filled cond. hermetically sealed and packed. Tobe type PT-SC-11 measuring 3 3/4"x2 5/8"x2 5/8". Stud mntg. centers 2". Plugs into standard four prong socket.

10 mfd.—400 V \$.65

10 mfd.—600V \$ 1.19

Pyranol. Brackets included

Table with columns for Mfd, Volts, Price, and various capacitor specifications like 50KV, 15KV, 25KV, etc.

TYPE "J" POTS \$.65

Table for Type 'J' pots with columns for Ohms, L (locking shaft), and various resistance values.

TYPE "JJ" POT \$ 1.50

Table for Type 'JJ' pots with columns for Ohms and various resistance values.

- ALSO -

Bathub Channel & Mica Condensers. Carbon & WW Pots. Pwr Resistors & Rheostats

MONMOUTH RADIO LABS

Box 159 Capital 2-0121 Oakhurst, N. J. Art Hankins, Owner

SPECIAL PURPOSE TUBES

Large table listing various vacuum tube models (e.g., OA2, OA2WA, OA3, OA5, etc.) and their prices.

ALL TUBES ARE NEW, INDIVIDUALLY CARTONED, FULLY GUARANTEED

western engineers

Orders for less than ten dollars cannot be processed

ELK GROVE, CALIFORNIA SUPPLIERS OF TUBES SINCE 1932

Prices are F O B shipping point

Write - Wire or Phone for:

NEW FREE FLYER!

Hundreds of excellent buys in air, marine and ground electronics, air frame and electrical parts, components, etc. Get your copy.

SEE INFRA-RED!

IP25A TUBE: Just released! Infra-red image converter made by Farnsworth. Limited quantity. Do not delay! Brand new. Only **\$24.95**

WIDE RANGE RECEIVER: 80-3,000 MC!
Far more sensitive than a radar receiver! We quote: "It is designed to detect radar signals beyond the effective range of the radar, to measure carrier frequencies from 80-3,000 mc and pulse repetition rates from 50-8,000 cps." In addition it is a direction finder! A special antenna installation is included for this purpose. Also includes its own power supply (115 V. 60-2400 cv.), a test oscillator for frequency calibration, audio amplifier with cathode follower output, visual indicator for tuning sharply, metered pulse amplifier and counter, and an elaborate antenna and RF detector unit. Brand new and complete with instruction and Maintenance Manual. A real steal at only **\$95.00**

ASK FOR OUR NEW RELAY CATALOG!

- Here are examples of buys to be found:
- ELECTROSTATIC RELAYS:** Plug-in, hermetically sealed, one SPST N.O., one SPST N.C., which operate on 1 mw-second of energy! No magnetic fields! No magnetic coil! No magnets - period! Uses electro-static ceramic to transfer the silver-palladium contacts when charged to 100 V. Brand new. Either one **\$9.95**
 - WESTON SENSITROL MODEL 705 TYPE 6:** SPDT. Polarity at 40 ohm coil determines which contact makes, 400 microamps (16 mv) sensitivity. Stationary contacts are permanent magnets which latch the moving contact. Contacts rated ultra-conservatively at 1 A. D.C. Resets by monetary application of 115 V., 60 cy. to the reset coil. Brand new and a **\$93.50** value **\$12.95**
 - Sigma sealed sensitive polarized SPDT octal plug-in #280030.** Snap-action contacts latch on momentary coil current. Reversing the coil polarity snaps the common to the other contact. Contacts rated 2 A at 8 V D.C. The sample we tested snapped at 0.42 ma. 5000 ohm coil sensitivity is rated 0.9 ma. New. Only **\$2.95** (Write for quantity prices.)
 - FREE!** At request, with your polarized relay order, a new brochure on the optimum design of Wheatstone Bridges for control circuitry. Equations provide vast improvement over symmetrical resistances. ALSO: Steppers, delayers, latches, etc.

PAY LESS THAN \$18.00 FOR \$800.00 FREQ. METER!

Brand new Navy, original packing, with instruction book containing schem. and operating instr. Crystal-calib. with harmonics rest 470 mc. Is Het. freq. meter and Sig Gen. Output of 10 mw either CW or 90% AM with 30 kc sine wave or 100% AM with 10 u-sec pulse at 1 kc. The AF pulse also available at 50 & 6,000 ohms. RF either CD or AM. Is at 80 fitting, 50 ohms, or radiated from antenna supplied. Input 80 or 115 v. 50 to 800 cy. This power supply alone is worth more than our GIVE-AWAY PRICE! With headset, cords & attenuator, plus complete tech manual. LU-1: 470-493.5 mc. Cat. No. 2808TY2. SHP wt 65 lbs. BRAND NEW: **\$17.95** ONLY LU-3: 465-498.5 mc. Cat. No. 2008TY1. SHP wt 65 lbs. BRAND NEW: **\$19.95** ONLY.

VHF CHECKER WITH SCOPE DISPLAY 150-240 MC

Brand new unit made for Air Forces, so you know that it is made right. Signal generator feeds pulsed RF to your receiver. Output of your receiver is displayed and measured accurately. Built in AC power supply 115 V, any frequency from 50 to 1200 cy. Also use the scope to analyze HI-FI amplifiers by pulsing its sweep from your square wave generator. Each sweep will present one complete pulse from your amplifier's output. Shpg wt 52 lbs. A \$1200 set. BRAND NEW. with **\$42.50** tubes and instruction book. TS-182. Only **\$42.50**

SIGNAL GENERATOR-WAVEMETER 155-235 MC 460-570 MC

AN/UPM-1 was designed and built as a complete analyzer of Shoran, beacon, and transponder equipment AN/APX-(), MK-III, Rebecca, Eureka, etc. Has 115 V., 60 cy power supply and accessories. Excellent condition **\$99.50**

GO/NO-GO TEST SET X-BAND WAVEMETER ECHO BOX

TS-120/UP test set wave meter assembly. 2 1/4" OD x 2 3/4" OA length. Tuned cylindrical cavity, with 2 standard flange wave guide fittings diametrically opposite each other. Flanges are 1 5/8" square and slot is 1 3/32". The entire assembly mounted by 3 faced-off threaded ears. A standard hairline indicator rides against a 2 3/4" dial calibrated 0 to 18, in 180 steps, over approximately 270 degrees of the dial circumference. Standard bakelite knob and shaft friction drive the calibrated dial, to provide restatable micrometer tuning. Brand new in original waterproof packing. This is symbol number M-102 in the test set and is the SPECIAL. Shpg. wt. 4 lbs. **\$39.50**

FRONT END FOR HARMONIC AND NOISE ANALYZER

AN/APR-1 is broad-band tuner 38-80 mc. output is 30 mc. Requires low currents at 6.3 V AC and 250 V B plus. Individually hand-calibrated curve supplements direct-reading vernier dial when greater accuracy is desired. Brand new in storage container CY-57/APR-1. **\$24.50**
A steal at only

NEW ARRIVALS
All unused Excellent condition

TS-3/AP	\$95.00
TS-3A/AP	\$25.00
TS-92/AP	\$7.50
TS-867A/AP for APA-44	\$72.50
1-203-A RF WATTMETER	
For SCH-720	\$9.50
And MANY more	What do YOU Need?

BRAND NEW IMPEDANCE-BRIDGE SPECIAL

Designed not only to measure reactance and resistance of components, but also to measure antenna and transmission line resistance and reactance of components, but also to measure antenna and transmission line resistance and reactance at frequencies from 25 kc to 5 mc. Complete with accessory box of plug-in standards and educational instruction book with a special section devoted to antenna measurements. No power is required for the bridge. Carry it anywhere you carry your signal generator. This unit will have always needed to load and trim antennas to get all the power of your customers' transmitters into the air. Here is accurate laboratory equipment, made for the U.S. Navy to exactly duplicate a commercial bridge presently being sold for \$390. SHP wt 60 **\$125.00**
All prices F.O.B. subj. to change without notice. Items subj. to prior sale.

ARROW SALES, Inc.

OFFICE AND MAIN WAREHOUSE:
7460 VARNA AVE., NO. HOLLYWOOD, CAL.
Mail to: BOX 3007-E, NO. HOLLYWOOD, CAL.
Phones: Stanley 7-0406 Poplar 5-1810
Telegraph: WUX, NO. HOLLYWOOD
Cable: ARROWSALES, NO. HOLLYWOOD
CENTRAL WAREHOUSE & SALES SHOWROOM
2441 S. MICHIGAN AVE., CHICAGO 16, ILL.
OTHER WAREHOUSES IN:
Atlanta, Ga., San Antonio, Tex., Pasco, Wash.,
Sacramento, Cal., Burbank, Cal.,
Los Angeles, Cal.

HERSHEL SPECIALS

BRAND NEW Electronic PHOTO FLASH 100 Watt Sec.



Operates on any 12 or 24 VDC. source. Complete with ignition coil, trigger housing and strobe light. Assembly includes 20 ft. cord with SYLVANIA A-1073. (Similar to Sylv. 4330.) Extra Parts Kit has Extra 1073 bulbs, tubes, vibrator, instruction Manual.

\$29.95 Ship. Wt. 60 lbs.

BUTTERFLY CONDENSERS YOUR CHOICE \$4.95



These units make the finest tuners for Ultra-high frequency transmitters, receivers, frequency meters, and oscillators.

- TYPE A: 4 1/4" Dia. Type A-106 330 mc. Resonator type
- TYPE B: 4 3/8" Dia. Type B-125 680 mc.
- TYPE C: 2 1/2" Dia. Type C-100 1000 mc. Ultra 388.5 lbs.
- TYPE D: 2 1/2" Dia. Type D-100 1000 mc. Ultra-Fred Out.

RELAYS

- 3VDC 11-OHMS D.P.D.T. 3A. CONTACTS \$1.29
- 6VDC 24-OHMS D.P.S.T. 8A. CONTACTS \$1.95
- 110VAC 15A. CONTACTS 5 P.S.T. \$1.75
- TELEPHONE TYPE 7500-OHMS S.P.D.T. 2A. CONTACTS \$2.49

OIL CONDENSER \$1.65

- 2 MFD. 3000 VDC. W/Pyranol Oil W/Mounting Brackets
- 1-1 MFD. 3000 VDC. New. Removed from equip. 4 3/4" x 4 3/4" x 2 1/2"

GE Pyranol Oil CONDENSER 95¢

- 12 MFD. 330 VDC. Removed from equip. NEW.

RCA Output Transformer \$1.95

- 6L6's 25 WATTS
- Pri. 5000 ohms output SEC. 21 500 ohms 2 800 ohms side-tie 15 to 15,000 cy. rat.

PHOTO ELECTRIC CELL 95¢

95¢ CE Vacuum Cell used in A.M.P.F.D. Sound Projector. Also useful for opening garage doors and Alarm Systems.

ALL-PURPOSE FIL TRANSFORMER \$4.95

- PRI. 117 v. 40 cyc. sec.
- 4 v. 12A
- 6 v. 10A
- 8 v. 8A
- 12 v. 5A
- 250 v. 1/2A

Hi Gain Dynamic Mike Kit \$195

Use UTC Transformer & Western Elec. Mic. Ideal for Home PA, CAP, Recording Mobile Equip. -50 DB 80 to 7500 cps. Diagram Furnished.

SWING CHOKE \$5.95

24-7H 350 MA. Thoradson T48003.

100 ASSORTED CRYSTALS \$7.95

FT-243 FT-241A FT-171B Type Holders FREQUENCY RANGE 2015 KC to 38.1 MC. Value \$50.00

HOTTEST BUY IN THE U.S.A.

ALLIGATOR CLIP 2 for 25¢

Piercing type with 3 ft. cord and test clip. TL-137.

HERSHEL RADIO CO. 5247 GRAND BLVD. Detroit 8, Michigan

TERMS: Cash with order or 25% DOWN-BALANCE C.O.D. ALL PRICES NET F.O.B. DETROIT MINIMUM ORDER \$2.00

Tyler 8-9400

CONSISTENTLY HIGH QUALITY ELECTRON TUBES

AT SENSIBLE PRICES! Largest stock in the country. ALSO Large diversified selection of TEST & COMMUNICATIONS EQUIP. WRITE For latest comprehensive catalog and tube price sheet

BARRY ELECTRONICS CORP. 512 Broadway, N. Y. 12, Walker 5-7000 TWX: N. Y. 1-3731

FOR MORE QUALITY-PER-DOLLAR, BUY RECONDITIONED

TEST EQUIPMENT

WE WILL QUOTE ON NEW AND USED TOP-QUALITY COMMERCIAL BRANDS AND SELECT MILITARY SURPLUS ITEMS IN OUR CHOICE STOCK, TO YOUR NEEDS.

AN/APR-4 LABORATORY RECEIVERS

Complete with all five Tuning Units, covering the range 38 to 4,000 Mc; wideband discone and other antennas, wavetraps, mobile accessories, 100 page technical manual, etc. Versatile, accurate, compact—the aristocrat of lab receivers in this range. Write for data sheet and quotations.

We have a large variety of other hard-to-get equipment, including microwave, aircraft, communications, radar; and laboratory electronics of all kinds. Quality standards maintained. New Reduced Prices On: LARGE POWER UNITS, DYNAMOMETERS, SHAKETABLES. SPECIAL: NEW SURPLUS RAYTHEON 5721 WIDE-BAND KLYSTRONS, \$85.00.

ENGINEERING ASSOCIATES

434 PATTERSON ROAD

DAYTON 9, OHIO

BIGGEST & BEST in Surplus Communications Eqpt.!

WESTERN ELECTRIC 250/350 WATT RADIOTELEPHONE EQPT.

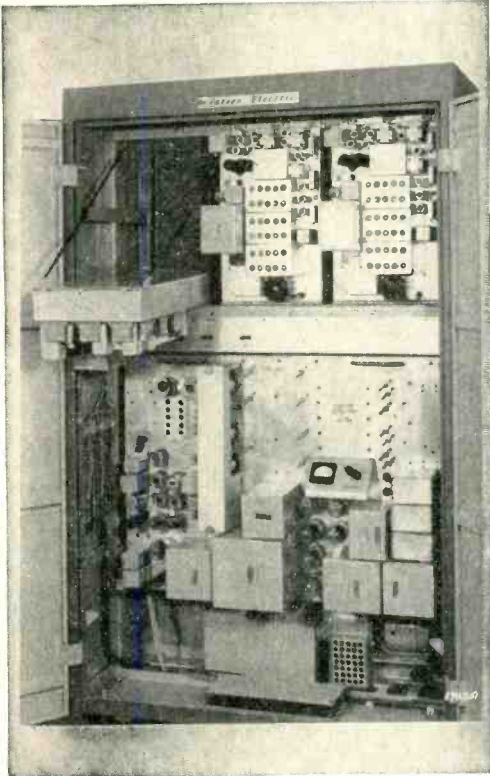

- ★ ALL NEW, UNUSED EQPT. NOT GOV'T SURPLUS.
- ★ 30 CHANNELS TRANSMIT & RECEIVE, CRYSTAL CONTROL, 2-20 MC RANGE.
- ★ MONITORS 3 SEPARATE CHANNELS SIMULTANEOUSLY.
- ★ MOTOR DRIVEN CHANNEL SWITCHING.
- ★ VOICE OPERATED CARRIER, OR PUSH-TO-TALK, AS DESIRED.
- ★ SALT AIR CORROSION RESISTANT, HERMETICALLY SEALED TRANSFORMERS, ETC.
- ★ IDEAL SUBSTITUTE FOR SCR-299, 399, OR 499 EQPT.

WRITE FOR PRICES & LITERATURE

LAB & PRODUCTION TEST EQUIPMENT AT LOW PRICES!!

TS-587/U FIELD INTENSITY METER. 15 to 400 MC. Operates from 115 V. AC. Mfd. by Stoddard Aircraft Radio Co. Excellent, clean condition.

TS-14/AP. Radar Test Set, 3200-3370 MC. Operates from 115 V. 50-800 cps AC.

TS-497A/URR SIGNAL GENERATOR. Covers 2 to 400 MC in 6 bands. Operates from 115 V. 50/60 cycles AC.

MODEL OT STANDING WAVE MEASURING EQPT. For measuring complex impedance of concentric and other antennae in 100-225 MC. range. Operates from 115/1/60 c. AC. Mfd. by RCA.

MODEL LAF SIGNAL GENERATORS. RF generator pulse modulated, range 90 to 600 MC; in portable case 26"L. x 14"W. x 18"H. Operates from 115/1/60 c. AC.

IE-36 TEST SET, used for checking SCR-522 Trans-Receiver.

IE-19A, for checking and aligning SCR-522 or equivalent UHF Trans-Receiver. Consist of 1-95 Field Strength Meter, Signal Generator-I-130A, and Battery Box-BX-33. All contained in wooden chest. Excellent condition.

TS-173/UR FREQUENCY METER. Similar to SCR-211 (BC-221) but 90.0 to 450.0 MC. Excellent condition.

BC-1236A SIGNAL GENERATOR. 2 bands, 15 to 40 MC and 90 to 230 MC. Modulation at 400, or 625, or 1623, or 8200 cps. Calibrated RF Microvolt Meter and Ferris-type microvolt attenuator. Operates from 115/1/50-60 c. AC.

MANY OTHER TYPES! ALL AT CLOSE OUT PRICES!

50 WATT FM TRANS-RECEIVING STATIONS, 30-40 MC, 110/1/60c. OPERATION X'tal Control Transmitter and Receiver. Beautiful design and construction by REL, all contained in handsome cabinet 40"H. x 21½"L. x 11½"D. Complete with handset, tubes, Instruction Book, etc. Like New Condition. Descriptive literature available. PRICE EACH.....@275.00

S04 SHIPBOARD RADAR, X BAND, AVAILABLE. NEW, COMPLETE, WITH INSTRUCTION BOOKS, EXPORT-PACKED. WRITE FOR PRICES AND LITERATURE!!!

LARGE QUANTITIES

NEW & RECONDITIONED:

BC-669 (SCR-543) RADIOTELEPHONES, NEW-UNUSED, 50 WATTS OUTPUT ON PHONE, 6 CHANNELS (CRYSTAL-CONTROLLED) FOR TRANSMITTER & RECEIVER.

SCR-300 (BC-1000) Walkie-Talkies; SCR-536 (BC-611) Handy-Talkies. SPARE PARTS for both eqpts.

BIGGEST & BEST STOCK IN: TCS Transmitters & Receivers with 12, 24, 110 DC or 110 AC Power Supplies.

50 W. PORTABLE BROADCAST STATIONS, 1,100 to 1,500 KC. NEW-COMplete, with Studio Console, 2-Speed Turntable, Studio Microphone, etc.

SCR-284; BC-224; BC-312; 342 & 348. SCR-510, SCR-511, SCR-610, SCR-619. VHF EQUIPMENT SCR-522, BC-797, SCR-624, TDQ, RCK, & VHR-401A RECEIVERS. LINK & LEAR FM MOBILE & FIXED STATION EQPT.

SCR-296A COAST ARTILLERY RADAR SETS, for surface search and artillery gun control. Accuracy ±20 yds. at 100,000 yds. max. range. Available Complete, with spares, at tremendous savings!

Finest Stock of X'MTTRS & RADIOTELEPHONES for FIXED STATION INSTALLATION, 50 Watts to 10 KW.

Write for Prices & Literature

ALL MATERIAL SUBJECT TO PRIOR SALE!
CABLE ADDRESS: TELEMARINE, N. Y.

—TELEMARINE— COMMUNICATIONS CO.

3040 W. 21 Street, Brooklyn 24, N. Y.

Phone: ES 2-4300

EXPORTERS, GOVERNMENT AGENCIES, INDUSTRIALS!

We have large stocks of Transmitters, Receivers, Walkie-Talkies, VHF Equipment, Radar, Accessories, etc. Write and tell us of your requirements. Descriptive literature and prices upon request.

MINIATURE 60MC IF STRIP uses 6 ea. 6AK5 tubes, with synchronous single tuned interstage coupling networks realizing an overall gain of 100db for a band width of 2mc. Weight 9 ounces, \$12.50.



3cm. Crystal Mount. Broad band. BNC teflon connector. Airtight. VSWR less than 1.0. Brand new \$24.50

COMPLETE RADAR PLUMBING FRONT END. c/o 2K25 local osc. mount, 2K25 beacon mount, type N adapter, crystal mount with tuning slug, variable attenuator, beacon xtal mt. beacon N adapter. Also matching duplexer assy. Latest type Navy Radar. Ideal for radar front end or as a complete laboratory bench set up. Price incl. duplexer \$52.50. Less duplexer \$42.50. Brand new electrical and mech. tested.

COAX MIXER ASSEMBLY IN21 type crystal detector RF to IF. "N" fittings, matching slug, duplex couplings, mfg G.E. New, \$18.50.

THERMISTOR MOUNT 10CM. "N" coax input. New \$18.50.

COMPLETE SURFACE SEARCH RADAR U. S. Navy type "SO" Raytheon 275kw nominal pulsed output 3000mc. "S" band. Rotating yoke plan position indicator with 2, 4, 20, 80 mile range selection. Input 115vdc. 32vdc. or 28vdc. Lightweight. Delivered complete with installation accessories, set of drawings, instruction books, export cased. Write, phone,

GUIDED MISSILE BEACON.

FILTER CAVITY F-28/APN-19 2700-2900 mc. 1.5 db max. loss at ctr. freq. over band, 3db at 15 mc band ends. JAN spec. Brand new \$37.50.

CRYSTAL MOUNT p/o AN/APN-19 and 60. 10cm. Low level converter matching RF line to crystal. New \$19.50.

RADAR BEACON RECEIVER R-149/APN-19. Comprises a microwave RF crystal detector, video amplifier stages and duty cycle limiter and blocking oscillator, plus control circuits. Operates on 2 channels in the 2100 to 3600mc. region with a band width of 300mc. when filter F-28/APN-19 (above) is not used. Used excellent condition\$125.00 ea.

POWER SUPPLY DY-30/APN 19 (for above) 19.5vdc input. Regulated output 300v60ma & 100v10ma. Bendix dynamotor DA31A\$44.50

TS46/AP FREQUENCY METER complete 3000mc band coverage with accuracy of .5mc relative, absolute plus and minus 3mc. 200 microamp. meter. Micrometer adjust. Equal to TS117. New \$35.00.

RADIO-RESEARCH INSTRUMENT Co.
550 - 5 Ave., N. Y. 36, N. Y. Tel: JU 6-4691
PAUL J. PLSHNER

10cm. Klystron mount.

Type N output. Tunable over range. For Shepard tube ie. 726 etc. Complete. Brand new. \$15.00

TS-311 ECHO BOX. Range 8730-8910mc. Dial direct reading. Accuracy plus minus 5mc. Ringtime - 4000 yards nominal. Mfg. Western Electric. Used exco. condition. \$225.00 each.

3KW 400 CYCLE SOURCE

Complete generator set. 115VDC 3HP speed regulated, compound motor. Generator output 115 volts, 400 cycle, single phase 17.4 amp. transformer. Output electronically regulated. Perfect waveform. Built to rigid U. S. Navy spec. Drive motor easily swapped for any other input you wish. A perfect source of pure 115 volt 400 cycle. Excellent condition \$385.00 each.

LORAN. RCA current type LR-8802. Complete coverage of S. L. H rate stations. Built in digital computer. Direct reading. Binary and decade counters actuated by stable 100 kc crystal osc. 115v 60 cycle input. Total 67 tubes incl. 32 type.

PRESSURIZED WINDOW 1 x ½" guide Varian V-1100 New \$5.50.

CF-1 WESTERN ELECTRIC TELEPHONE CARRIER 4 channel carrier bay. Brand new and complete. 2C51. Exe Cond. Write-Phone.



NEW YORK TUBE & MICROWAVE TEST EQUIPMENT EXCHANGE

Special! TS45 X BAND GENERATOR—\$99.00

NEW UNUSED SURPLUS TS 259 K BAND

23400-24500 MEGACYCLES SIGNAL GENERATOR

SPECIAL! 5,000 V. POWER SUPPLY

For IP25 Infrared Image Converter from 3 V. Battery Source. **\$990**

NEW MICROWAVE TEST EQUIPMENT TS148/UP SPECTRUM ANALYZER TS147D SIGNAL GENERATOR

Field Type X Band Spectrum Analyzer. Band 8430-9580 Megacycles. Will Check Frequency and Operation of various X Band equipment such as Radar Magnetrans, Klystrons, TR Boxes. It will also measure pulse width, c-w spectrum width and Q, or resonant cavities. Will also check frequency of signal generators in the X band. Can also be used as frequency modulated Signal Generator etc. Available new complete with all accessories, in carrying case.

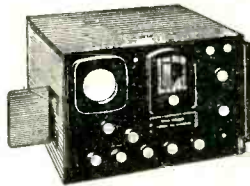

OTHER TEST EQUIPMENT USED CHECKED OUT SURPLUS

TSK1/SE	T35/AP	TS108	TS226	SURPLUS EQUIP. APA10 APA38 APS3 APS4 APR4 APR5A APT2-APT5 and many others
TS3A/AP	TS36/AP	TS110/AP	TS239A-TS239C	
RF4/AP	1-96A	TS125/AP	TS251	
TS12/AP	TS-45	TS126/AP	TS258	
TA13/AP	TS47/APR	TS147	TS270	
TS14/AP	TS63/AP	TS174/AP	TS418	
TS33/AP	TS100	TS175/AP	TR890/1	
TS34/AP	TS102A/AP	TS182	834	

SPECIAL

Thousands of tubes available at special prices

PARTIAL LIST

2AP1	6H6	307A	5691
4C27	6K8G	274A	5692
4C28	6AR6	274B	5693
5A6	5R4WGY	262B	5639
5BP4	5W4GT	328A	5814
4J52	0Z4A	357A	9001
2A4G	6AC7	450TH	9002
6C21	28D7	450TL	9003
6J5GT	VT52	957	9006
	89	MANY OTHER TYPES	

WHOLESALE and EXPORT ONLY
Minimum tube order \$25



LIBERTY ELECTRONICS, INC.

Phone: OREGON 4-7070

119 PRINCE ST.
NEW YORK 12, N. Y.
Cable: TELESERUP

SAVE dough! / HARJO!

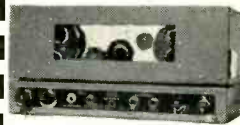

SAVE 90% PORTABLE WIRE RECORDER

Type IC/VRW-7. Manufactured by CBS for the U. S. Navy. Requires only 24-28 volts DC at 70 W. for complete operation. Ideal for recording conversations between pilot and tower. Has two inputs for mike and radio receiver, and two outputs for headphones. U. S. Navy ACQ approximately \$350.00. (Can be used on 6 and 12 V. cars, boats, etc.) with small available inverters.) **\$3500**

A HARJO SPECIAL! **FOB Burbank, Cal.**

INDUSTRIAL CONDENSERS

- A) 80 mfd. 4,000 volts. Cat. 14F204 \$49.95
 - B) 100 mfd. 4,000 volts. Cat. P15902 \$69.95
 - C) 120 mfd. 3,000 volts. Cat. 18P268 \$69.95
- (All Famous Makes)

1-222 SIGNAL GENERATOR-MICROVOLTER

Freq. range 8-15 MC. & 150-230 MC. Complete with all tubes and 5 MC. Calibrating Crystals. Self-contained 110 V. and 60 cycle power supply. With Schematic. Cost the Govt. approx. \$700.00 Brand New..... **\$49.95**

RCA TV CAMERA

NEW Surplus 100's SOLD! Only few left at this price!



Ideal for labs, industry, prisons, TV technicians, swim pools, medical—"mechanical eye" for closed circuit TV, 1840 Iconoscope, 6-stage video amplifier and clipper. THE REAL THING! Send for new, free, complete technical data: **SOLD AT FRACTION OF REAL VALUE!** Only **\$197.50**

TEST EQUIPMENT

AN/GPM-14	TS-125
LAG	TS-143
TS-10C	TS-182
TS-13	TS-184
TS-15	TS-204
TS-16	TS-251
TS-19	TS-261
TS-24	TS-268
TS-32	TS-294C
TS-33	TSX-45E
TS-34	I-56
TS-35	I-122
TS-36	I-166
TS-45	I-177
TS-47	I-222
TS-59	IE-12
TS-89	IE-19
TS-92	IE-36
TS-110	

GROUND ELECTRONICS

ARB	BC-342
ART-13	BC-344
BC-191	BC-348
BC-222	BC-375
BC-224	CRT-3
BC-312	TCS-12
BC-314	

AIRCRAFT ELECTRONICS

ARC-1	ARC-27
ARC-3	MN-62
ARC-4	MN-55
ARC-5	LP-21
ARC-12	LP-31
ARN-6	AS313-B

POWER ELECTRONICS

DY-11	PE-206
DY-12	5D2INJ3A
DY-17	
PIONEER 12143-2A	
PIONEER 12117	
PIONEER 12123	
PIONEER 12133	
PIONEER 12142	

RADAR EQUIPMENT

APA
APS-4, -6
APS-15
SCR-717, -720
SL
APQ-13
T-116/APT-5A

1,000's of other Items
Tell us your needs!

IMPORTERS—EXPORTERS!

Write us in fullest confidence. Lowest prices. Dependable merchandise, certified by CAA if desired, quick delivery and prompt action on foreign inquiries in all languages!

Harjo Sales Co.

Office-Warehouse: 503 N. VICTORY BLVD. BURBANK, CALIF. Phone: Thornwall 5-2613

Equipment - Components - Test Sets

National Communications Receiver — RBL-5. Frequency 15-600Kc. 6 Bands. Self Contained 115V. -60 Cycle Power Supply.—Labs, Schools, Industrial users have bought these from us. We supply brand new, original pack, with tech manuals (shipping wt. 100 lbs.) at a fraction of original Govt. cost—\$59.95 fob N.Y. *Tube Type 5933/807W—(Ruggedized 807). Brand new Sylvania ind. boxed. 1.59 ea.—Dozen 15.00.

Dumont Oscilloscope—Exc. operating condition (used) =224A—Clean—75.00.

*Tube Type OB2 (Min. VR Tube) Brand new, ind. boxed, ea. 65¢—Dozen 7.00.

Butterfly Tuning Unit, TN18—R.O. AN/SPRI—300-1000 Mc. 5.00

Test Set TS-45A/APN-3—New—w/Tech. Manual. 29.95

Test Set TS-56—New—Slotted Line—59.95

1% Panel Meter 0-1 Mil—4" Sq. Mirror Scale—Roller Smith—New 7.00

Modulation Transformer—Case—Mfgd by Chicago for Collins. 6000r to 6000r—20 Watts—Cases—New—ea. 1.25—10 for 10.00

Type J Potentiometer—100,000 Ohms w/sh Ea. 40c

Miniature Motor (DeJur) 0-200 w/a—New Ea. 4.00

I-208 Signal Generator—Exc. Cond. Ea. 59.95

*Bakhtov Condenser—2 Mfd—600VDC—Side Term'l Ea. 39¢; 100 for \$30.00

Power Supply TRC-5 (115V—60 cy.) Exc. 49.95

*Microphone Transf. (Mfgd by Chicago for Collins) PRI-75-Sec 125,000 CT (All Specs on Case) Ea. 1.00

*Large Quantities Available.

REX RADIO SUPPLY CO.
88 Cortlandt St., New York 7, N. Y.
Cortlandt 7-1617

FIBERGLAS BASE BAKELITE

BRAND NEW, NATURAL COLOR

Mfd. by Mica Insulator Company

30 sheets 1/16" x 36" x 36", 6# per sheet \$1.25/lb.
45 sheets 1/8" x 36" x 36", 13# per sheet... 1.00/lb.
48 sheets 3/8" x 36" x 36", 34# per sheet... .75/lb.
22 sheets 1/2" x 36" x 36", 46# per sheet... .60/lb.
.40c lb./lot price. Inspection Invited

ELECTRO SALES CO., INC.

50-58 Eastern Avenue, Boston 9, Mass.

GLASS TUBING

PYREX - NONEX - URANIUM BULB & CYLINDERS
WRITE FOR FREE MONTHLY LIST

HOJDE SUPPLY COMPANY

PHONE KEYPORT 7-1286
M. R. #1 Box 86X Keyport, N. J.

NEW ADVERTISEMENTS

received by March 4th will appear in the April issue subject to space limitations.

Classified Advertising Division

ELECTRONICS

P. O. Box 12 New York 36, N. Y.

RADAR

P.P.I. REMOTE REPEATERS

- VD-7" Upright
 - VE-7" Table Type
 - VF-5" "B" Scope "5" P.P.I.
 - VG-"24" Plotting Table
 - VJ-12" Upright
 - VK-12" Upright
 - VL-12" Upright R.H.I. IND.
- All indicators are 110v 60 cyc.

RADALAB INC.

87-17 124th St., Richmond Hill 18, New York, N. Y.

Phone Virginia 9-8181-2-3

OVERSEAS CUSTOMERS CALL US DIRECTLY BY TELEX OVERSEAS TELETYPE TWX N. Y. *4-4361

**AN/APR-4
38-4000 MC RECEIVER**



RDO

NAVY SEARCH RECEIVER

The RDO is a very elaborate radar search receiver greatly improved over the APR-4. The set uses APR-4 tuning units, but is much more versatile, having input metering, D.B. output meter, automatic noise limiter, and greater selectivity and sensitivity. The RDO is recommended when only the very best will do. Input 110v 60 cyc.



AN/ASQ-1 AIRBORNE MAGNETOMETER

This is an airborne chart recording magnetometer. The set consists of an amplifier, oscillator, detector head, chart profile recorder, power supply. The equipment has a sensitivity of 2 gamma. The AN/ASQ-1 records on an Esterline angus recorder disturbance in the earth's magnetic field. An indicator is provided that gives a bearing on a magnetic disturbance. Input is 28v DC. Weight about 130 lbs.

SHORAN

AN/APN-3-AN/CPN-2

The AN/APN-3 and AN-CPN-2 are Precision distance measuring installations. This equipment operates on 225 mc. The range is 250 miles with an accuracy of 25 feet. This equipment is widely used by geological companies for prospecting and mapping. Power input is 110v 400cyc and 28v DC.

AN/GSQ-1 SPEECH SCRAMBLER

This is a unit designed to be attached to either a radio or telephone circuit to scramble speech or code. This equipment utilizes coded cards in each terminal equipment. Unless the properly numbered card is inserted on the receiving end the speech can not be unscrambled. This provides an excellent privacy system. 24 VDC input. Mfg. Western Electric.

AN/TPS-1B

200 MILE AIR SEARCH RADAR

The TPS-1B is a very late type L-band mobile or portable air search radar. This set will detect aircraft up to 200 miles and up to 40,000 ft. The set is composed of small portable carrying cases that are bolted together to make up the set. A 7" P.P.I. and a 5" "A" scope are provided. This set is in use by the Air Force and Marine Corps. Complete sets available. P.O.R.

AN/TPS-3-AN/TPQ-3

Airsearch or artillery shell tracking radar. The AN/TPS-3 is a 600mc airsearch portable radar. The set has a range of 120 miles on aircraft up to 40,000 ft. This set has a 7" P.P.I. and a 5" "A" scope. The AN/TPQ-3 is a modification of the AN/TPS-3 to provide mortar and artillery shell tracking and plotting. A computer is provided to compute shell trajectories and provide information for counterbattery fire. This set is completely portable and can be set up in the field in a few hours. Complete sets avail. P.O.R.

AN/TRC-1-3-4

100 MC RADIO-RELAY EQUIPMENT

The AN/TRC series is a mobile portable set for duplex or simplex radio telephone point to point communication. This set will operate with the CF series carrier systems to provide multi channel operation. The TRC operates on 100 MC with an output of 10-50 watts. The set is crystal controlled. Complete sets avail. with all components. Input 110v 60 cyc.

CARRIER EQUIPMENT

- CF-1 4 CHAN. VOICE AND TELEG. TERMINAL 115v 230v A.C. 12v D.C.
- CF-2 4 CHAN. TELEGRAPH AND TELETYPE TERMINAL 115v 230v A.C. 12v D.C.
- CF-3 4 CHAN. INTERMEDIATE REPEATER 115v, 230 A.C. 12v D.C.
- CF-4 CARRIER CONVERTER. Used to adapt the CF-1 and 2 for operation on a simple 2 wire trans. line instead of using spiral 4. 115v, 230v A.C. 12v D.C.
- TH-1 TELEGRAPH TERMINAL

SCR-536 HANDI-TALKIE

Freq. range 3.7.5 Mc crystal controlled battery operated handi-talkie. The range of this equipment is approximately 2 miles. We can supply these sets to your specified freq. Completely reconditioned and guaranteed.

WE CAN SUPPLY OVER 1500 OF THESE SETS

MISC. EQUIP.

- SCR-193 1.5-18 mc field radio
- SCR-291-A 1.5-20 mc direction finder
- SCR-300 40-48 mc walkie-talkie
- SCR-399 1.5 mc-18 mc mobile radio
- SCR-499 1.5 mc-18 mc field radio
- SCR-508-528 28 mc F.M. field radio
- SCR-608-628 30 mc F.M. field radio
- SCR-506-A hand radio
- SCR-694 field radio
- AN/ARN-6 Airborne D.F.
- AN/ARN-7 Airborne D.F.
- AN/APN-9 Loran
- AN/APA-11 pulse analyzer
- AN/APA-17 300-10,000 direction finder
- AN/APR-1 38-4,000 mc receiver
- AN/APR-5 1,000-3,100 mc receiver
- AN/APR-6 3,000-10,000 mc receiver
- AN/ART-3 THRU 11 jammer
- AN/ARQ-1 THRU 12 jammers
- AN/APQ-2 THRU 9 jammers
- AN/PRT jammers
- AN/ARC-1 100-156 radio set
- AN/AN/ARC-12 200-325 mc radio set
- AN/ARC-27 200-400 mc radio set
- AN/ARS-2 THRU 34 airborne radar
- AN/PRC 6 handi-talkie FM
- AN/PRC-8, 9, 10 walkie talkie FM
- AN/GRC-9 field radio
- AN/GRC-3-8 FM field mobile radio sets
- AN/TCX-1 page printing facsimile
- AN/TRC 7 100-156 mc walkie talkie
- AN/UPN-1, 2, 3, 4 radar beacons S & X Bands
- AN/CPN-6 & 8 radar beacons S Band
- SCS-51 instrument landing systems
- RC-115B 75 mc marker ground set
- SA, SC, SK, SO, SX, other navy radars

Noise and field strength measuring equipment
Commercial mobile, portable radio sets, Motorola, G.E., Hellcrafters, RCA, Etc.
Test sets TS-1 THRU 800
We specialize in radar and radio, countermeasures equip.
Spare parts for all types of radio and radar equipment
We have many late types of MIL equip. made after WWII. Write
Many types of AN/Types of test sets in stock
If what you want is not listed write anyway

AN/ARC-12

AIRBORNE 225-350 MC TRANSCEIVER

TRANSMITTERS

Portable To High Power

RECEIVERS

All voltage inputs

SPARE PARTS

for a wide range of equipment

**COMMUNICATION ACCESSORIES,
ANTENNAS, MICROPHONES,
GENERATORS, DYNAMOTORS,
CABLES, FITTINGS, ETC.**

For all types of
**SIGNAL CORPS, MARINE
and INDUSTRIAL USE.**

Late Models Available in Quantity

AN/PRC-8-9 and 10
with spare parts.

AN/GRC-13
Field Communication Sets,
Complete.

**WE ARE NOW
AT OUR
NEW PLANT
ADDRESS**

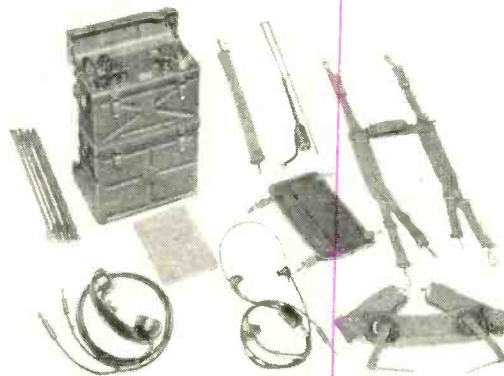

SCR 300 Portable "Walkie-Talkie" Radio Transmitter-Receiver operating on frequencies of 40.0 to 48.0 Mcs. Employs 18 miniature tubes with output of 1/2 watt. Sturdy, compact and dependable. All units completely checked for operation and guaranteed.

SPARE PARTS for (SCR-300)

5 Gang Variables, I.F. Transformers, XTALS, 6815 K.C., 4300 K.C., SOCKETS, R.F. & OSC Coils, Input - Output Transformers, Jacks, Fittings, CS-128 Cases, Plugs, Cables, Antennas (AN-130, 131), Handsets, Switches, Resistors, Condensers and Manuals.

LARGE QUANTITIES ALL NEW

GUARANTEE

- Our equipment carries with it an unqualified guarantee of satisfaction to the end user.
- Our new laboratory is equipped with the finest testing facilities available.
- Catalog and data sheets fully describing our offerings and hundreds of other items in our stock will be gladly mailed on request.

**BRAND NEW
T-350XM
RADIOTELEPHONE
RADIOTELEGRAPH
TRANSMITTER**

This transmitter is similar in characteristics to the RCA Model ET-4336. The T-350XM was manufactured by Technical Radio Corporation, San Francisco, California, for the U. S. Signal Corps. All are new, unused and export cased. Each transmitter carries our guarantee. Spare parts available. Quotations on request.
● 2,000-20,000 KCs ● 350 watts—A1 Output ● 250 Watts—A3 Output ● Built in Master Oscillator ● 5 Crystal Positions ● Multi Range Impedance Antenna Tuning Network ● Manual or High Speed Keying ● Uses 2-813 P.A. and 2-805 Modulators Hi-Level Class B ● Speech Amplifier, Remote, Mfg. by RCA ● Technical Manuals (2) with Each Transmitter ● Size 59" x 16" x 21" ● Wt-690 Lbs. Net ● Power Input: 210/250 Volts Single Phase 50/60 Cycles ● Brand new—Complete—Unused

COMPLETE STATION INSTALLATION
We can supply with the T-350XM transmitter brand new receivers and complete station operating accessories.

SEARCH RECEIVER ARD-2

Measures RF signals, 80 to 3000 mcs. and pulses from 50 to 8000 cps. Can be used as a direction finder or as a frequency meter by visual and aural indicators. Suited for military, laboratory or general purpose use. Equipment consists of the following: ANTENNA DETECTOR CMD-66AFH; AMPLIFIER CMD-50ADC with POWER SUPPLY, 115 V.A.C. 60 to 2400 cps. regulated; TEST OSCILLATOR CMD-60ABG. All cables and fittings, accessories, shock mounted rack, technical manuals; SPARE PARTS including two extra sets of spare tubes, EXPORT PACKED in original CASES, WEIGHT— \$295.00 113 lbs. PRICED LOW AT

COMMUNICATION DEVICES CO.

Cable: COMMUNIDEV, N. Y. 269 EAST SHORE ROAD, GREAT NECK, N. Y. Telephone: HUNTER-2-2320, 1, 2

TEST SETS

Hundreds of different types of test equipment, military as well as commercial types. Please advise your needs

- TS-35A/AP—X Band Signal Generator and Power Meter. Input—110/1/50—1200 cps. Can generate and measure RF power. New\$175.00
- MAG—10cm remarkable link radar, portable, operated from 6 volt battery, uses folding antenna and tripod. A pair at.....\$1750.00
- APS-3—3 cm—Airborne radar for search and homing. 5-in. scope. 10 brand new sets at \$750.00 ea
- APQ-13—Very late model airborne radar set, complete and new. One only at.....\$2,950.00
- SCR-545—Complete radar set, less vehicle, antenna and power plant, pretty fair condition, sold as-is at\$1,375.00
- TS-13/AP-X BAND RADAR TEST SET—Measures power, freq. signal-to-noise ratio, I.F. Bandpass, etc. Input—115/1/60—800
- TS-100/AP—TEST SCOPE, type A, R, J & X indications, gated & ungated sweep. Int. or Ext. trigger.
- ANTENNA ASSEMBLY—Reflector is a light-weight parabolic cylinder. Ass'y has both manual and motor drive. Ideal unit for labs, classroom demonstration, small craft, etc....\$49.50 ea

TRANSMITTERS

- SCR-284—The famous mobile and ground equipment station for field use, complete with all accessories. Range 3.8—5.8 mcs; 20 watts cw, 5 watts phone.
- SCR-510—Mobile, portable FM radio station. Operates from 6, 12, or 24 volt dc supply. Frequency range: 20.0 to 27.9 mcs.
- SCR-610—Same as SCR-510, but with built-in speaker and range of 27.0-38.9 mcs.
- SCR-528—Mobile FM radio station, operates from 12 or 24 volt dc. Frequency range: 20.0-27.9 mcs.
- SCR-628—Same as SCR-528, but with range: 27.0 to 38.9 mcs.
- BC-325—400 watts c.w., 100 watts new or voice operates from 110 or 220 volts ac. Freq. range: 1.5-18.0 mcs. Master oscillator or crystal control.
- 14C—400 watts phone or 800 watts c.w. Operates from 220 volts ac. Freq. range: 2.0-18.1 mcs. Has automatic dial selection of anyone of ten preset channels. Mfr. Western Electric.
- TCS—Collins, Navy radiotelephones for shipboard and mobile use, complete with all accessories for operation from 12, 24, 110, 230 volts d.c. and 110 or 220 volts a.c.
- TBK—High frequency transmitter, 2-20 mcs; 500 watts output. Supplied complete with m/g and starter for d.c. or a.c. operation.
- TBL—All-wave transmitter; 350 watts output; CW and phone. Supplied complete with m/g and starter for d.c. or a.c. operation.
- TAJ—Intermediate freq. transmitter, 175-550 kcs; 500 watts output. Supplied complete with m/g and starter for a.c. or d.c. operation.
- TBN—200-3,000 kcs, complete with 220/440 volt, 3 ph. 50-60c power supply—conservatively rated at 1 kw. output.

MOTOR GENERATORS CONVERTERS

50, 60, 400 and 800 cycle and DC Power Supplies

- DUAL OUTPUT GENERATOR: 115/1/400 @ 50 Amps and 28 V. DC @ 17.9 Amps. NEW, MOUNTED OR UNMOUNTED. Write
- 28dc to 110/1/800 @ 1kva.....\$49.50 (Overall length 12 inches)
- 110dc to 110/1/800 @ 350va.....150.00
- 110 ac to 110/1/800 @ 350va.....235.00
- 110/1/60 to 110/1/400 @ 2kva.....400.00
- 110dc to 28dc @ 250va.....49.50
- 110/1/60 to 28dc @ 250va.....97.50
- 220/1. 3/60 to 28dc @ 250va.....97.50
- 110dc to 110/1/60 @ 1.25kva.....135.00
- 220dc to 110/1/60 @ 1.25kva.....145.00
- 110dc to 110/1/60 @ 350va.....85.00
- 110dc to 110/1/60 @ 500va.....95.00
- 110dc to 110/1/60 @ 5kva.....285.00

SYNCHROS & SELSYNS

- 1F\$55.00
- 1SF55.00
- 1G55.00
- 1DG42.50
- 5F35.50
- 5G39.50
- 5SG45.00
- 5SDT27.50
- 6DG\$34.50
- 6G49.50
- 7G49.50
- 2J1F110.00
- 2J1G110.00
- 2J1H110.00
- AY-43 autotryn

• DESIGN, MODIFICATION, PRODUCTION, AND TESTING OF COMMUNICATIONS AND RADAR EQUIPMENT

COMPASS ELECTRONICS SUPPLY

A Division of Compass Communications Corp.

75 Varick Street
New York 13,
N. Y.



CANAL 6-7455
Cable Address:
Compradio, N. Y.

A BARGAIN FOR YOU in a....

SOLA Constant Voltage TRANSFORMER

End Fluctuating Line Voltage

BIG DISCOUNT OFF . . .

the factory price of a 1-input 2,000 VA unit! And here's another bonus! This Air Forces 2,000 VA overstock, Sola Cat. No. 30768, has 4 inputs! 90-125 V., 190-250 V., 60 cy. or 50 cy. Isolated secondary is constant 115.0 V. ± 1% from no-load to full-load of 17.4 amp. So, if you choose, use it as a 220-115 V. step-down. And slash \$97.50 off the factory 1-input price! Brand new in original wood box. 4 cu. ft. Ship. wt. 254 lbs. F.O.B. Pasco, Wash. Only. **\$147.50**



(EXPORTERS: Note choice of 50 cycles.)

THE M. R. COMPANY

P. O. Box 1220-B Beverly Hills, Calif.

SELLING

- Receivers
- Transmitters
- Radar
- Special Purpose Tubes
- Relays
- Meters
- Switches
- Connectors
- Rectifiers
- Transformers
- Motors & Generators
- Wiring Cable
- Instruments and
- All Electronic Components

WILL BUY ALL

New or Used

- Leach Relay =5059-R
- =5058
- =5055
- =5053-SM
- =5053
- Price Bros. Relay =10
- Relay =5586
- =5587
- Antenna Switching Relay
- Box # CBY 23049
- # BC-AN-198
- # BC -408
- Tubes =53A
- VT-127A VT-227A
- 35T VT-327A
- WL-530 15E

Highest prices paid for most all types of aircraft sparkplugs any condition

RADIO & ELECTRONIC SURPLUS

14000 BRUSH STREET
Detroit 3, Mich. TO 9-3403

Wholesale Only

Wholesale Only

we will pay you

TOP \$\$\$.

for an AN/ARN-6

or any of its components

AS-313 LOOP

Phone us collect

Stanley 7-0406

on above items

SIMILAR FABULOUS PRICES FOR:

- APR-9 . . . ARC-1 . . . ARN-7 . . . ART-13
- PARTS . . . BC-788-C . . . LP-21-AM, -LM, or
- MO-18A or MC-507 from these loops
- I-152C . . . R-65/APN-9 . . . TEST SETS I-100,
- TS-117, -125, -147, -148, -488.

ARROW SALES, INC. Dept. E.

7460 VARNA AVE., NO. HOLLYWOOD, CAL.

CASH PAID!

Sell your surplus electronic tubes. Want unused, clean transmitting, special purpose, receiving, TV types, magnetrons, Klystrons, Broadcast, etc. Also want military & commercial lab test and communications gear. We swap too, for tubes or choice equipment. Send specific details in first letter. For a fair deal write, wire or telephone: WALKER 5-7000

Barry, 512 Broadway, New York 12, N. Y.

TUBES NEEDED

- #6550 6336 6072 6080 5881 65R7
- 65J7 65T7 CK527AX CK5854 CK5785
- 6V6GT 6H6
- DUTCHESS LABS
- 38 Catskill Ave. Poughkeepsie, N. Y.
- Tel. Grover 1-2650

To Get Most Dough / Sell to Harjo!

We're Buying: BC-224 & BC-348 RECEIVERS.

ARC-3 ART-13 BC-788 R5/ARN-7

Cash or trade. Quick action. Top money!

HARJO SALES CO. Dept. B
503 N. Victory Blvd. Burbank, Calif.

- ART-13/T47A Transmitters\$175.00
- ART-13/T47 Transmitters\$125.00
- BC-788C Alt.\$175.00
- A R C - 3 Transceiver Complete\$325.00
- R5/ARN-7 Radio Com. pass\$160.00
- SHIP via Express C.O.D. Subject to Inspection to H. FINNEGAN, 49 Washington Ave. Little Ferry, N.J.
- WANTED
- BC-348 Rec'r Unmodifed Q and R Models \$50.00
- A R C - 1 Transceiver \$225.00
- BC-342 Rec'r ..\$ 50.00
- BC-312 Rec'r ..\$ 40.00

Current purchase of RECEIVING, TRANSMITTING AND SPECIAL PURPOSE RADIO TUBES

Send special offers with net price and types to:

W-1882, Electronics
Class. Adv. Div., P.O. Box 12, N. Y. 36, N. Y.

SAVE UP TO 70% OF WHOLESALE COST

TYPE "J" POTENTIOMETERS
2 Watt Carbon
Full Range of Values Available From Stock for Immediate Delivery
Single Type J Units \$.95 Ea.
Dual Type JJ Units 2.95 Ea.
Triple Type JJJ Units 3.95 Ea.
SEND FOR COMPLETE LISTING

TEFLON and KEL-F INSULATED HOOK-UP WIRE

In Stock for Immediate Delivery
VARIOUS COLORS and SIZES
Inquire For Complete Listing
At Money Saving Prices

PRODUCTION QUANTITIES

PRECISION POTENTIOMETERS

50K 10 Turns 0.5% Linearity—Van Dyke Instr. Miniature Type
3/4" dia. x 2-1/4" lg. \$7.95 Ea.
20K 10 Turns 0.1% Linearity—Gibbs Micropot. \$6.95 Ea.
10K 25 Turns 0.1% Linearity—Helipot. \$19.50 Ea.
10K 10 Turns 0.5% Linearity—Helipot. \$6.95 Ea.
10K 10 Turns 0.1% Linearity—Helipot. \$7.50 Ea.
2K 10 Turns 0.1% Linearity—Helipot. \$6.95 Ea.
Helipot Duo Dials available for above.

HI CURRENT FILAMENT TRANSFORMERS

AMERTRAN type W-PRI-105-125V 60cy 1 pb-SEC. 5V. 190amp. 35KV Ins Ea. \$29.50
KENYON - S-14940 - PRI - 105-125V 60cy 1 pb-SEC. 5V 115 amp. Ea. \$19.50
MIL-T-27 Type-PRI-115/230V 50/60 cy-SEC. 5V 10 AMP 10 KV Ins. Ea. \$6.25

ALL COMPONENTS 1ST QUALITY AND 100% GUARANTEED

TUBES

NEW—COMPLETELY GUARANTEED

750TL \$19.95 Ea.	807W \$1.75 Ea.
FG-172 \$15.00 Ea.	8002R \$12.95 Ea.

FULL LINE OF RECEIVING TUBES, POWER TUBES, MAGNETRONS, KLYSTRONS, CRYSTAL DIODES AVAILABLE AT SIMILARLY LOW PRICES.

IMMEDIATE DELIVERY

KOLLSMAN SERVO MOTORS WITH TACH GENERATOR

TYPE 890-0160640-MOTOR-115V-60Cy. 2 Ph. 3350 RPM-5 Watts Output. GEN. 6.5V/1000 RPM. \$59.50 Ea.
TYPE 1623B-0410120 Motor-26V-400 Cy-2 Ph.-6500 RPM .045 Watts Output. GEN. 0.34V/1000 RPM. \$42.50 Ea.

SOUND POWERED PHONES

Head and Chest Set
U. S. NAVY TYPE "M"
Heavy Duty Includes Headset, Chest Mike and 20 Ft. Cord. \$14.88 Ea.
T. S. 10 Type S.P. Handset. \$9.48 Ea.

Terms: 20% cash with order. bal. C.O.D. unless rated. All prices net F.O.B. our warehouse Phila., Pa. subject to change without notice.

Special Discounts on Quantity Purchases

WE INVITE YOUR INQUIRIES FOR ALL YOUR ELECTRONIC NEEDS

SYNCHROS

COMPLETE LINE OF COMMERCIAL ARMY AND NAVY TYPES

1CT \$37.50	5N \$22.50
1DG 37.50	5SDG 12.50
1HCT 42.50	5SF 29.50
1F 42.50	5SG 29.50
1G 37.50	6G 34.50
3D 62.50	6GD 27.50
3HCT 62.50	6HG 42.50
5B 22.50	7G 47.50
5CT 34.50	7DG 42.50
5HCT 42.50	23CX6 45.00
5F 34.50	21F1 4.95
5G 34.50	21G1 3.95

MANY OTHER TYPES IN STOCK QUOTATIONS ON REQUEST

PULSE TRANSFORMERS

OVER 50 TYPES LOW AND HIGH POWER TYPES IN STOCK FOR IMMEDIATE DELIVERY

MFD. BY UTAH, G.E., RAYTHEON, PHILCO, WESTINGHOUSE, WESTERN ELECTRIC, ETC.

132AW2F 7P1	\$6.95
134BW2F 7P4	6.95
176AW2F 7P10	7.50
139DW2F 7P13	5.95
148DW2F 7P15	7.60
Utah X124T2-9262	12.50
Utah X139T1-9278	3.75
G.E. 68G825	14.50
G.E. 68G627	16.50

SEND US YOUR INQUIRIES

POLYSTYRENE CAPACITORS

1% Tolerance
Hermetically Sealed-200VDCW-500VDC
0.5 MFD \$7.50 Ea.
1 MFD \$12.10 Ea.
Mfd. by Western Electric. Brand New

FROM ONE OF THE LARGEST INVENTORIES IN THE U.S.A.

TEST EQUIPMENT

HEWLETT-PACKARD AUDIO OSCILLATOR Model LA-20-20,000 cy. *\$85.00

BC-221 FREQUENCY METER 125 KC to 20,000KC—Accur. .05% *\$115.00

TS-33/AP FREQUENCY METER 8700-9500MC—Accur. .03% *\$145.00

TS-34/AP OSCILLOSCOPE 30cps to 1MC —Portable *\$195.00

LAE-1 Signal Gen. (510-1300MC) \$225.00

LAF Signal Gen. (90-600MC) \$325.00

LAG Signal Gen. (1200-4000MC) \$375.00

LP-5 Signal Gen. (0.5KC-50MC) \$425.00

Measurements 79B Pulse Generator \$165.00

Waterman 3" Hackscope S-12-B \$325.00

Hewlett Packard 325-B—Distortion Analyzer \$220.00

Dumont 208 Oscilloscope *\$80.00

GENERAL RADIO

GR 572B 1KC Hommer 7.50
GR 700P1 Volt. Divider 27.50
GR 713B Beat Freq. Osc. *225.00
GR 715 AE DC Amplifier 225.00
GR 720A Het. Freq. Meter 275.00
GR 723C VT Fork 1KC 85.50
GR 726A VTM (Battery Oper.) *85.00
GR 727A VTM (Battery Oper.) *105.00
All items new except where noted *Excellent Used—Guaranteed)

2.4KVA POWERSTAT

Superior 5649
Input—115/230V 60 cy. 1 ph.
Output—0-270V 9 Amps.
Brand New.
Special Price \$37.50 Ea.

WRITE FOR A COMPLETE LIST OF SURPLUS EQUIPMENT

LECTRONIC RESEARCH LABORATORIES

715-19 Arch St., Phila. 6, Pa. • Market 7-6771-2-3
Cable Address: LECTRONIC, Philadelphia

CONSISTENTLY HIGH QUALITY ELECTRON TUBES

AT SENSIBLE PRICES!
Largest stock in the country.

TEST & COMMUNICATIONS EQUIP.

WRITE
For latest comprehensive catalog and tube price sheet

BARRY ELECTRONICS CORP.
512 Broadway, N. Y. 12, Walker 5-7000
TWX: N. Y. 1-3731

New Advertisements

received by March 4th will appear in the April 1st issue subject to space limitations.

Classified Advertising Division

ELECTRONICS

P. O. Box 12 New York 36, N. Y.

KOILED KORDS 3 wires \$126
22 inches long stretches to 9 ft.

GONIOMETER

TYPE CFT-47372 — 250 to 1500 K.C.

nitelighter—Automatic light switch. Darkness throws the switch — turns lights on at dusk — off at dawn. Fools burglars who watch for signs of an empty house. Same as your city buys for \$45 on top of lamp posts. **\$1595**



TELECHRON Motors

2 RPM ... \$2.90	1 RPM ... 3.95
3 RPM ... 3.90	3 R.P. Hr. ... 2.85
4 RPM ... 2.90	1 R.P. 2Hr. ... 2.80
3.6 RPM ... 3.15	60 RPM ... 4.85
1 RPM—50 Cycles, \$1.85	

Laboratory Special 1 of Each Motor \$25

PLEASE INCLUDE POSTAGE

BLAN
EST. 1923

64 L Dey St.
New York 7,
N. Y.

General Radio **VARIACS** in stock. Special Sale on a few 200-B (1 amp.) removed from equip't. \$8.95

HAND WOUND 10 Sec. to 24 Min. **TIMER SWITCH** \$1.35

6 Watt Most **POWERFUL TELECHRON MOTOR** 110V 60 Cy
6 RPM reversible \$10.00
1 RPM \$6.50



HAYDON TIMING MOTORS

110v 60 cycle 30 RPM ... \$2.60
110v 60 cycle 1 RPM ... 2.60
230v 52 RPM 1.00
60 cy/1 RPM 1.00

HANSEN Synchro 4 rpm \$4.24
CRAMER 4 rpm \$4.65

DIEHL-DELCO

P. M. motors. Made for 24 volts. Will work at lower speed at 12v. or 6v. Battery or Rectifier. Size 1"x1"x2" **\$375**



A N C O N N E C T O R S

FAST DELIVERY

FROM STOCK

LOW PRICES

Let us quote on your requirements.

All comply with government specifications

Wilgreen Industries

99 MURRAY ST., NEW YORK 7, N. Y.
WOrth 4-2490-1-2

Cadmium or olive drab finish.

RELIABLE TUBES

1B37/6034	\$7.50	2K55	15.00	V45	500.00	723A/B	11.00	5643	6.00	5838	7.00	6035	25.00
1B60	27.50	2K56	45.00	V57	300.00	725A	30.00	5645	6.50	5839	8.00	6037	175.00
1P41	1.50	3B26	6.00	RK71/6D21	150.00	804	10.00	5646	6.50	5851	5.00	6038	10.00
2C33/233A	5.00	3D22	15.00	BL77	30.00	807	1.50	5647	7.00	5852	7.00	6098	6.00
2C40	9.50	4C33	95.00	QK103	100.00	807W/5933	3.25	5650	75.00	5857	35.00	6111	7.50
2C43	10.00	4J52	45.00	QK181	50.00	811A	3.50	5657	150.00	5876	12.50	6115A	80.00
2C46	6.00	4X150A	22.50	QK185	90.00	829B	8.50	5670	2.25	5893	15.00	6116	150.00
2C52	3.00	5JP2A	10.00	QK202	200.00	832A	7.00	5675	10.00	5894	15.00	6161	55.00
2J36A	90.00	5LP2A	17.50	QK243	175.00	CK1026	3.00	5687	2.75	5896	4.00	6167	40.00
2J41	125.00	5Y3WGTA	3.25	261A	15.00	R1111	5.00	5702	1.75	5899	4.00	6177	100.00
2K25	18.00	6AJ5	1.50	268A	3.75	R1131C	10.00	5703WA	3.00	5901	7.00	6201	3.25
2K26	45.00	6BF7W	4.00	QK278	275.00	1633	.75	5721	140.00	5902	4.00	6202	2.75
2K28	30.00	6BL6	32.00	312A	1.50	1636	.50	5744	1.75	5906	10.00	6229	240.00
2K29	35.00	6BM6	35.00	339A	4.50	CG1984	15.00	5751	2.25	5937	75.00	6326	275.00
2K33	125.00	6J4	2.00	397A	45.00	R4340	25.00	5764	50.00	5949/1754	90.00	6339	25.00
2K39	165.00	65K7W	1.00	416B/6280	40.00	5528/C6L	5.50	5787	4.50	5969	12.00	6383	75.00
2K40	100.00	6X5WGT	1.50	420A/5755	7.50	5550	22.50	5794	6.00	5976	50.00	6524	12.50
2K41	110.00	7F8W	3.00	RT434	25.00	5557/FG17	4.50	5801	4.75	5981	75.00		
2K45	45.00	PJ8/5556	10.00	UE576	35.00	5636	4.00	5814A	1.50	6021	4.00		
2K48	60.00	25Z6WGT	3.75	707B	12.00	5639	6.00	5814WA	2.75	6029	2.75		
2K50	175.00	FG27A	18.00	721B	6.75	5641	5.00	5819	40.00	6032	150.00		

ALL mdse guaranteed. 24-hour telephones take your orders any time for prompt servicing. Material subject to prior sale.

PAGE ELECTRONICS

136 Liberty Street

Cortlandt 7-4245

New York 6, N. Y.

WIRE: MAGNET

• Immediate
Delivery
from Stock

RESISTANCE,
HOOK UP:
PLASTIC,
BRAIDED,
KE-L.F.,
TEFLON

MEETING ALL MIL.
FEDERAL SPECIFICATIONS

ATLANTIC & PACIFIC WIRE & CABLE CO., Inc.

112-01 Northern Boulevard, East Elmhurst, L. I., N. Y. Hickory 6-1080

NEED METERS?

STANDARD or SPECIALS

ANY QUANTITY—NEW—MILITARY

FOR ELECTRONIC—MILITARY
AIRCRAFT—HAMS

ALL MAKES—MODELS
RANGES—SIZES

METERS REPAIRED
RESCALED
RECALIBRATED

WRITE - PHONE - WIRE

INSTRUMENT SERVICE

76-14 Woodside Ave.

Elmhurst 73, N. Y.

CAA No. 4264 Ltd. HA 9-2925

"SEARCHLIGHT" Can Help You!

Hundreds of miscellaneous business problems that confront you from time to time, can be solved through the use of the SEARCHLIGHT SECTION of ELECTRONICS.

When you want to buy or sell used or surplus new electronic equipment and/or accessories, or have other business wants — advertise them in the SEARCHLIGHT SECTION for quick, profitable results!

We offer:

FOR EXPORT ONLY

RECEIVING, TRANSMITTING & SPECIAL PURPOSE TUBES
RADIO & TELEVISION SETS & PARTS — TESTING INSTRUMENTS
CATHODE RAY TUBES — TRANSISTORS — DIODES — SEMI CONDUCTORS
PROJECTOR, REFLECTOR, GERMICIDAL & OTHER TYPE OF LAMPS
FLUORESCENT LAMPS—BALLASTS & STARTERS—ELECTRICAL CLOCKS
ELECTRICAL APPLIANCES — HOUSEHOLD & BATHROOM SCALES
HEARING AID BATTERIES — WIRE & CABLES

All merchandise direct from outstanding U. S. Manufacturers—Original Packing—No Surplus or distressed lots—We take care of Export Formalities for account of Foreign Customers. WILL QUOTE AGAINST SPECIFIC REQUEST.

MILANO BROTHERS

250 West 57th Street

Tel. Circle 6-0375

Cable: MILANBROS, NEW YORK.

CONSISTENTLY HIGH QUALITY ELECTRON TUBES

AT SENSIBLE PRICES!

Largest stock in the country.

• ALSO •

Large diversified selection of

TEST & COMMUNICATIONS EQUIP.

WRITE

For latest comprehensive
catalog and tube price sheet

BARRY ELECTRONICS CORP.

512 Broadway, N. Y. 12, Walker 5-7000
TWX: N. Y. 1-3731

ATOMIC ENERGY AN CONNECTORS

ONLY ONE OF ITS SIZE AND TYPE CAPABLE
OF CARRYING UP TO 10,000 VOLTS.

For all your voltage requirements. 20
amp. gold alloy contacts—tiny—size of
your index finger.

Available in 1 doz. lots @ .87 cents each

SANFORD ESTES & COMPANY

ELECTRICAL DIVISION

4548 Cottage Grove Chicago 15, Ill.

TUBES • ALL FAMOUS ADVERTISED BRANDS ONLY • TUBES

RMA GUARANTEE—From 10% to 95% Below Manufacturers Price—Look and Compare

Special Prices to Quantity Buyers. Most of Our Tubes are Jan.—95% are Original boxed — Brands such as R.C.A., G.E., Ken-Rad., Sylvania, Tung-Sol and Raytheon.

Table with multiple columns listing tube types (e.g., AB150, CB150, 6X4) and their prices.

Manufacturers, exporters, and large quantity users—Inquire on your letterhead for our inventory listing of receiving tubes, special purpose tubes, resistors, condensers, and other radio and television parts.

Table with multiple columns listing tube types (e.g., HY-65, REL-21, RK-34) and their prices.

FAY-BILL DISTRIBUTING CO. DEPT. E1 418 Broome St., N. Y. 13, N. Y. Telephone Canal 6-8404

COAX CONNECTORS SO239 24¢ 831R M359A 15¢ 831AD

FOR SALE Ecco Induction Heater Mfd. by Ecco High Frequency Corp. Type TO-5-1, 220V, 60 Cy., 1 Ph., 2B Amp. AC Supply, 6 KVA output, portable on wheels.

RELAYS world's largest stock

INFRARED SNOOPERSCOPE TUBE TYPE 6032—Infrared Image Converter Tube. Electrostatic focusing. Size 2x4 1/2". List \$150.00.

★ Immediate Delivery ★ Hundreds of Types ★ All Standard Makes ★ New-Inspected-Guaranteed See our ad on page 85

"TAB" THAT'S A BUY

Selected, GTD & Tested for resolution. Last image converter viewing tube. Hi-Sensitivity simplified design. Willemite screen. Resolution up to 350 lines in Tube & Data.



WESTON Model 45 Ranged-150VDC/Lab. Std. 545

G.E. MICROWAVE Sic Generator 9 to 11cm/3333 to 2724 mes op/115V/60cy. CW or Pulsed. direct reading. \$200

WESTON Model 45 Ranged-150VDC/Lab. Std. 545

G.E. MICROWAVE Sic Generator 9 to 11cm/3333 to 2724 mes op/115V/60cy. CW or Pulsed. direct reading. \$200

WESTON Model 45 Ranged-150VDC/Lab. Std. 545

G.E. Interval Meter measures elapsed time from 1/1000 to 2000 sec. in 8 ranges. 001, 003, 01, 03, 0.1, 1 & 3 sec.

G.E. Interval Meter measures elapsed time from 1/1000 to 2000 sec. in 8 ranges. 001, 003, 01, 03, 0.1, 1 & 3 sec.

TEST EQUIPMENT G.E. YZ-1 Decade Scaling Unit for high speed

TEST EQUIPMENT G.E. YZ-1 Decade Scaling Unit for high speed

TEST EQUIPMENT G.E. YZ-1 Decade Scaling Unit for high speed

TEST EQUIPMENT G.E. YZ-1 Decade Scaling Unit for high speed

TEST EQUIPMENT G.E. YZ-1 Decade Scaling Unit for high speed

TEST EQUIPMENT G.E. YZ-1 Decade Scaling Unit for high speed

TEST EQUIPMENT G.E. YZ-1 Decade Scaling Unit for high speed

TEST EQUIPMENT G.E. YZ-1 Decade Scaling Unit for high speed

TEST EQUIPMENT G.E. YZ-1 Decade Scaling Unit for high speed

TEST EQUIPMENT G.E. YZ-1 Decade Scaling Unit for high speed

TEST EQUIPMENT G.E. YZ-1 Decade Scaling Unit for high speed

TEST EQUIPMENT G.E. YZ-1 Decade Scaling Unit for high speed

TEST EQUIPMENT G.E. YZ-1 Decade Scaling Unit for high speed

TEST EQUIPMENT G.E. YZ-1 Decade Scaling Unit for high speed

New Five Way Binding Posts

Similar to Superior DF30, takes plugs, tips, 1/16 in. dia. panel, gold & nickel.

RPX050A 001 & 003 (SS) \$6.75

RPX050A Golden Treasure (DD) \$28.00

RPX050A Golden Treasure (DD) \$28.00

RPX050A Golden Treasure (DD) \$28.00

RPX050A Golden Treasure (DD) \$28.00

RPX050A Golden Treasure (DD) \$28.00

RPX050A Golden Treasure (DD) \$28.00

RPX050A Golden Treasure (DD) \$28.00

RPX050A Golden Treasure (DD) \$28.00

RPX050A Golden Treasure (DD) \$28.00

RPX050A Golden Treasure (DD) \$28.00

RPX050A Golden Treasure (DD) \$28.00

RPX050A Golden Treasure (DD) \$28.00

RPX050A Golden Treasure (DD) \$28.00

RPX050A Golden Treasure (DD) \$28.00

RPX050A Golden Treasure (DD) \$28.00

RPX050A Golden Treasure (DD) \$28.00

RPX050A Golden Treasure (DD) \$28.00

RPX050A Golden Treasure (DD) \$28.00

RPX050A Golden Treasure (DD) \$28.00

RPX050A Golden Treasure (DD) \$28.00

RPX050A Golden Treasure (DD) \$28.00

RPX050A Golden Treasure (DD) \$28.00

RPX050A Golden Treasure (DD) \$28.00

PRECISION POTENTIOMETERS

MULTIPLY 25, 100, 300, 2000, 5000, 10000, 20000 Ohms/0.5%

PRECISION RESISTORS 1% ACCURACY GTD

Shalleroes, W.E., Wilkor, I.R.C. Nepero & Others Carbofilin & Choice

Ohms Ohms Ohms Ohms Ohms Ohms

125 900 5000 253K 155K 1M

289 1500 7950 35K 250K 3.3M

375 1818 9445 47500 330K 5M

380 1830 9500 48600 333K 5.5M

380 1830 9500 48600 333K 5.5M

New Variable Voltage X-fmrs

SUPERIOR GR-STACO 0-135V/3A \$7.23

0-135V/3A \$7.23

0-135V/3A \$7.23

0-135V/3A \$7.23

0-135V/3A \$7.23

0-135V/3A \$7.23

0-135V/3A \$7.23

0-135V/3A \$7.23

0-135V/3A \$7.23

NEW G.E. PHONO CARTRIDGES

Original Boxed, Money Back Gtd.

RPX050A 001 & 003 (SS) \$6.75

RPX050A Golden Treasure (DD) \$28.00

RPX050A Golden Treasure (DD) \$28.00

RPX050A Golden Treasure (DD) \$28.00

RPX050A Golden Treasure (DD) \$28.00

RPX050A Golden Treasure (DD) \$28.00

RPX050A Golden Treasure (DD) \$28.00

RPX050A Golden Treasure (DD) \$28.00

RPX050A Golden Treasure (DD) \$28.00

RPX050A Golden Treasure (DD) \$28.00

RPX050A Golden Treasure (DD) \$28.00

RPX050A Golden Treasure (DD) \$28.00

RPX050A Golden Treasure (DD) \$28.00

RPX050A Golden Treasure (DD) \$28.00

RPX050A Golden Treasure (DD) \$28.00

ELECTRONIC FLASH! LUCKY PURCHASE \$59 SHAWLITE 40011 SPECIAL \$20

Assembled & ready to work! Not a kit. Latest Design. SUPERIOR CIRCUIT—Low cost filament

1100VDC @ 200ma. Brute Force filter, oil capacitor, Blendor, Bridge 866A Rectifiers & Fil

NEW "TAB" BUILT POWER SUPPLIES

1100VDC @ 200ma. Brute Force filter, oil capacitor, Blendor, Bridge 866A Rectifiers & Fil

AMOUNT GYRO ORDINANCE

AMOUNT GYRO ORDINANCE

"TAB" REGULATED POWER SUPPLY

LAB & HIFI, Built & ready to work. Uses "SOLA" constant voltage Filament & Power

NEW MICA CONDENSERS GTD.

Disc. Q'tys 100—May be ass'd.

Disc. Q'tys 100—May be ass'd.

"TABTRON" Rectifier Xfms

"TABTRON" Rectifier Chokes

"TABTRON" SELENIUM RECTIFIERS*

NEW "TABTRON" SELENIUM RECTIFIERS*

NEW "DIODES"

Boxed & Lead Jacketed

SYLVANIA S.A., CLEVELAND, KEMTRON

SYLVANIA S.A., CLEVELAND, KEMTRON

TEKAP-TABPAK®

High Current Power Supplies

ONE YEAR GUARANTEE

Variable 0-130 VDC

INDEX TO ADVERTISERS

Ace Electronics Associates.....	412	Bentley, Harris Mfg. Co.....	32
Acheson Colloids Co.....	371	Berkeley Div., Beckman Instruments, Inc.....	66, 67, 457
Admiral Corp.....	64	Bird & Co., Inc., Richard H.....	234
Advance Electronics Lab, Inc.....	451	Bird Electronic Corp.....	426
Aemco, Inc.....	214	Birabach Radio Co., Inc.....	486
Aeronautical Communications Equipment, Inc.....	343	Biwax Corporation.....	479
Aerovox Corp.....	320	Billley Electric Co.....	346
Ainslie Corporation.....	450	Bodnar Industries.....	463
Alreco, Inc.....	23	Boesch Mfg. Co., Inc.....	402
Air-Marine Motors Inc.....	308	Bolling Industries, Inc.....	479
Airpax Products Co.....	218, 219	Bomac Laboratories, Inc.....	291
Alcor Electronics Corp.....	359	Borg Corporation, George W.....	38
Alford Mfg. Co., Inc.....	459	Bourns Laboratories.....	372
Allegheny Ludlum Steel Corp.....	385	Brand and Co., Inc., William.....	377
Allen-Bradley Co.....	128A, 128B	Bristol Co.....	370
Allied Control Company, Inc.....	145-150	Brookhaven National Laboratory.....	440
Alpha Instrument Co.....	468	Brown & Associates Inc., W. A.....	492
Alpha Metals, Inc.....	338	Buckbee Mears Co.....	471
Alpha Wire Corp.....	440	Burdny Corporation.....	88
American Electrical Heater Co.....	248	Burnell & Co., Inc.....	9
American Lava Corporation.....	45	Burrughs Corp.....	118
American Machine & Foundry Co.....	439	Bussmann Mfg. Co.....	96
American Super-Temp Wires, Inc.....	475		
American Television & Radio Co.....	464		
Amperite Co., Inc.....	272		
AMP, Incorporated.....	93		
Ampex Corporation.....	229	CBS Hytron, A Div. of Columbia Broadcasting System, Inc.....	265
Amphenol Electronics Corp.....	222, 223	Calidyne Company.....	268
Anaconda Wire & Cable Co.....	42, 43	Cambridge Thermionic Corp.....	152, 153
Applied Science Corporation of Princeton.....	84	Camloc Fastener Corp.....	290
Arnold Engineering Co.....	13	Cannon Electric Co.....	130, 131
Astron Corp.....	273	Carborandum Company, Gobar Div.....	58, 59
Atlas Precision Products Co.....	391	Celco-Constantine Engineering Laboratories Co.....	226, 477
Automatic Metal Products Corp.....	431	Central Transformer Co.....	474
Autron Engineering, Inc.....	458	Chance Vought Aircraft, Inc.....	108, 109
Avnet.....	54	Chassis-Trak, Inc.....	444
		Chester Cable Corp.....	364
		Chicago Standard Transformer Corp.....	220
		Christie Electric Corp.....	479
		Churchill Lighting Corp.....	426
Baker Chemical Co., J. T.....	227	Cinch Mfg. Corp.....	205
Ballantine Laboratories, Inc.....	240	City of Jacksonville.....	432
Baltic Metal Products Co.....	455	Clarostat Mfg. Co., Inc.....	231
Barry Controls, Inc.....	21	Cleveland Container Co.....	334
Bartlett & Co., Fred F.....	492	Cohn Corp., Sigmund.....	456
Bausch & Lomb Optical Co.....	406	Coil Winding Equipment Co.....	78
Bead Chain Mfg. Co.....	483	Collectron Corp.....	483
Beaver Gear Works, Inc.....	447	Collins Radio Company.....	86, 87
Beckman Instruments, Inc. Process Instruments.....	476	Communication Accessories Co.....	99
Belden Manufacturing Co.....	48	Communication Products Company, Inc.....	462
Bell Aircraft Corp.....	335	Computer Instruments Corp.....	558
Bell Telephone Laboratories.....	338, 339	Computer-Measurements Corp.....	238
Bendix Aviation Corp.....		Constantin & Co., L. L.....	281
Eclipse-Pioneer Div.....	92	Continental-Diamond Fibre Div. of the Budd Company, Inc.....	33
Pacific Div.....	256	Continental Wire Corp.....	287
Scintilla Div.....	250		

ESSEX

Custom-Designs

ENCAPSULATED AND
HERMETICALLY SEALED

DELAY LINES

*to Your
Specifications*

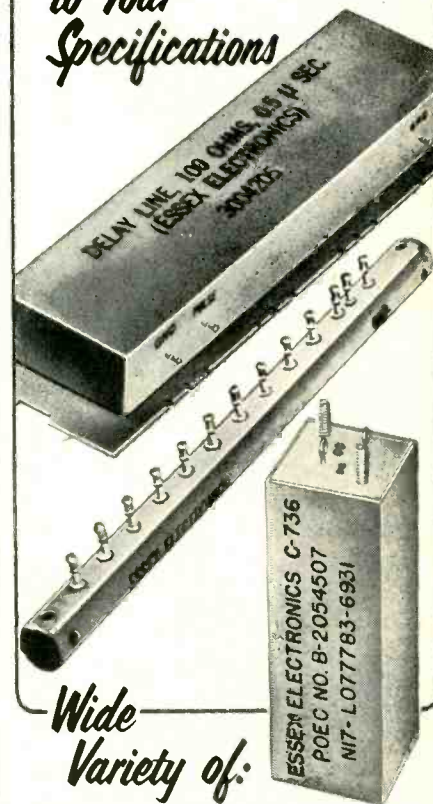

*Wide
Variety of:*

**DISTRIBUTED CONSTANT
DELAY LINES** designed for
fast rise time and low at-
tenuation made in flexible,
metal-shielded and stick
types.

**LUMPED CONSTANT
DELAY LINES** feature high
fidelity as well as compact
size.

The name, Essex Electronics, is
your reassurance of highest possible
product quality, efficiency,
performance and satisfaction.

Send specifications as detailed
as possible for prompt cost
quotations.



**ESSEX
ELECTRONICS**

Exec. Off. & Main Plant.
Berkeley Heights, New Jersey
CRestview 1-9300

Other Plants at:
7303 Atoll Ave., No. Hollywood, Calif.
Trenton, Ontario—Canada

Want more information? Use post card on last page.

NO CAMS . . . NO GEARS

NO LOSS of time with



AUMANN

High Precision

Layer Winding Assemblies
INFINITELY ADJUSTABLE TO WIRE SIZE

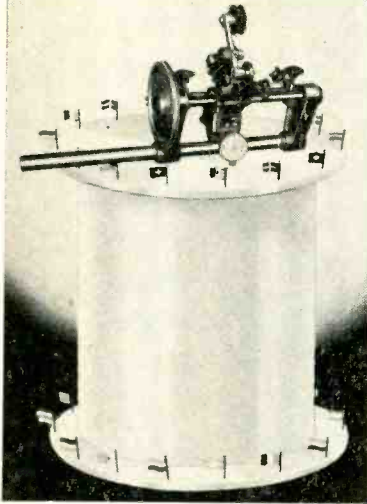

BOOTH 4405 at the I.R.E. Show
Industrial Winding Machinery Co.
HENRY W. ROEHRIG
Suite 3410, 120 Wall St., N.Y.C. 5
Whitehall 3-1754

FOR PUBLIC
ADDRESS, RADIO,
and kindred fields,
JONES 400
SERIES
PLUGS & SOCKETS

of proven quality!



P-406-CCT



S-406-AB

Socket contacts phosphor bronze cadmium plated.
Plug contacts hard brass cadmium plated. Insulation molded bakelite.
Plugs and sockets polarized. 2, 4, 6, 8, 10, 12 contacts
Steel caps with baked black crackle enamel.
Catalog No. 21 gives full information on complete line of Jones Electrical Connecting Devices — Plugs, Sockets and Terminal strips. Write

See the Jones Display at the I.R.E. Show—Booth 2535



Want more information? Use post card on last page.

Convair, A Div. of General Dynamics Corp.	332	Erle Electronics Division, Erie Resistor Corp.	428, 429
Cornell Aeronautical Laboratory Inc.	304	Essex Electronics	553
Cornell-Dubilier Electric Corp.	297	Essex Magnet Wire Division of Essex Wire Corp.	120
Corning Glass Works	97	Experimenters Supply Co.	491
Cornish Wire Co., Inc.	477		
Coto-Coil Co., Inc.	486		
Couch Company, Inc., S. H.	445		
Cross Co., H.	470		
Crucible Steel Company of America.	263		
Curtiss-Wright Corp.	488	F-R Machine Works, Inc.	243
		Fairchild Controls Corp., Components Division	383
		Fansteel Metallurgical Corp.	424, 425
Dale Products, Inc.	233	Federal Screw Products, Inc.	475
Dano Electric Co.	483	Fenwal, Inc.	245
Daven Company	3rd Cover	Filtron Co., Inc.	121
Daystrom Instrument	285	First Six	102
Daystrom Pacific Corp., A Subsidiary of Daystrom, Inc.	325	Formica Corporation	369
Daystrom Systems Division of Daystrom, Inc.	49	Frenchtown Porcelain Co.	467
DeJur-Amsco Corporation	103, 104, 105		
Delco Radio, Div. of General Motors.	110		
Delevan Electronics Corp.	282	Gamewell Co.	408
DeMornay-Bonardi	113	Gardner-Denver, Keller Tool Div.	271
Deutsch Co.	341	Garrett Corporation	260, 261
Dialight Corporation	423	General Ceramics Corp.	142
Diamond Antenna & Microwave Corp.	452	General Communication Co.	362
Diamonite Products Mfg. Co.	398	General Controls Potentiometer Div.	480
Donner Scientific Co.	432	General Electric Co. Apparatus Dept.	53, 72, 73, 241, 452
Douglas Aircraft Co., Inc.	417	Electronics Components Div.	112A, 112B 435
Dow Corning Corp.	132	Metallurgical Products Dept.	62, 63
Drakenfeld & Co., Inc., B. F.	467	Miniature Lamp Dept.	286
Driver Co., Wilbur B.	322	Semiconductor Products Dept.	48A, 48B, 48C, 48D, 48E, 48F
Driver-Harris Company	311	General Findings & Supply Co.	374
Dumont Laboratories, Inc., Allen B.	106, 107	General Mills, Mechanical Div.	376, 413
duPont de Nemours & Co. (Inc.) E. I. Polychemicals Dept.	363	General Radio Co.	17
		General Transistor Corp.	411
		Genisco, Inc.	267
		Globe Industries, Inc.	358
		Good-all Electric Mfg. Co.	307
		Grant Pulley & Hardware Corp.	353
		Graphic Systems	478
		Greater Miami Industrial Div.	467
		Green Instrument Co.	449
		Gries Reproducer Corp.	456
		Gulebrod Bros. Silk Co., Inc.	448
Eastern Precision Resistor Corp.	350	Hardwick Hindle Inc.	115
Eitel-McCullough, Inc.	90, 91	Harvey Hubbell, Inc.	50
Elco Corporation	269	Hathaway Instrument Div., Hamilton Watch Co.	321
Elcor, Inc.	555	Haydon Company, A. W.	404
Electra Manufacturing Co.	280	Haydon Mfg. Co., Inc.	394
Electro Instruments Inc.	68, 69	Heath Company	465
Electro-Measurements, Inc.	382	Heiland, a Div. of Minneapolis-Honeywell	51
Electro Motive Mfg. Co., Inc.	111	Helipot Corp., Div. of Beckman Instruments, Inc.	211, 422
Electro-Snap Switch & Mfg. Co.	305		
Electro Tec Corporation	299		
Electronic Associates Inc.	337		
Electronic Engineering Co.	306		
Electronic Fabricators, Inc.	309		
Electronic Instrument Co., Inc., (EICO)	460		
Electronic Research Associates, Inc.	302		
Electronics	126, 127		
Ellis & Watts Products, Inc.	135		
Empire Devices Products Corporation.	319		
Engineered Electronics Company.	360		
Epsco Inc.	357		

Hewlett-Packard Company	82, 83
Hexacon Electric Co.	481
Hickok Electrical Instrument Co.	276
Hitemp Wires Inc.	314
Hoffman Electronics Corp.	221
Hopkins Engineering Co.	470
Horman Associates, Inc.	493
Hudson Tool & Die Company, Inc.	367
Hughes Products, a Div. of Hughes Aircraft Co.	81, 249
Hughes Research & Development Laboratories	80
Hycon, a Sub. of Hycon Mfg. Co.	443

Indiana Steel Products Co.	136
Indium Corp. of America	242
Industrial Hardware Mfg. Co., Inc.	468
Industrial Instruments, Inc.	266
Industrial Test Equipment Co.	230
Industrial Winding Machinery Co.	554
Institute of Radio Engineers	251
Instruments for Industry, Inc.	454
Instrument Specialties Co. Inc.	437
Insuline Corp. of America	463
Interelectronics Corporation	478
International Business Machine Corp.	379
International Nickel Co., Inc.	323
International Rectifier Corp.	361
International Resistance Co.	122, 123
I-T-E- Circuit Breaker Co.	401

J-V-M Engineering Co.	446
Jet Propulsion Laboratory	403
Johns Hopkins University, Applied Physics Laboratory	310
Johnson Company, E. F.	468
Jones Div., Howard B. Cinch Mfg.	554
Jones Electronics Co., Inc., M. C.	396
Joy Manufacturing Co.	224

Kahle Engineering Co.	15
Kato Engineering Co.	469
Kay Electric Co.	29
Kearfott Co., Inc.	274
Kennedy & Co., D. S.	75
Kepeo Laboratories, Inc.	209
Kester Solder Co.	253
Kinney Mfg. Div., New York Air Brake Co.	433
Kintel (Kay Lab)	46, 47
KIP Electronics Corp.	416
Krengel Manufacturing Co.	455, 488
Kulka Electric Mfg. Co., Inc.	461

Laboratory for Electronics	420, 421
Lambda Electronics Corp.	387
Lampkin Laboratories, Inc.	475

.....SPELLMAN HIGH VOLTAGE POWER SUPPLIES.....

MODEL LAB-60 RF Type Continuously Variable 0-60 KV DC Regulated Power Supply

Current output 1 ma. at 60 KV. 2 ma. may be drawn from 50 KV to 0. Supplied with either positive polarity or negative polarity output.

LAB-60 Complete with meter.....\$695 Net
LAB-60 PN Reversible polarity model of above\$745 Net

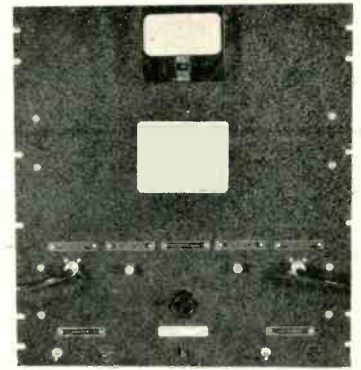

MODEL 4575 4½ KV POWER SUPPLY

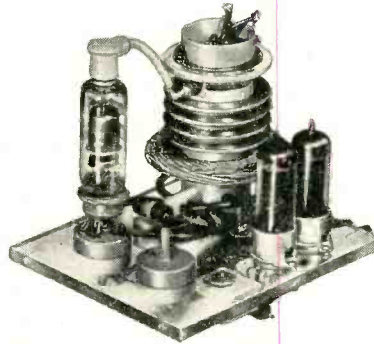

This compact, well designed, ruggedly built DC supply utilizes two 6AQ5 tubes as a parallel oscillator feeding a 1x2 rectifier tube. For an output voltage of 4½ KV DC at 1 milliamperes, the low voltage input requirement is 250 V at 50 milliamperes. By varying the DC input the output voltage can be varied from approx. 1 KV to 7½ KV. Dimensions: 5½" high x 5" deep x 4½" wide. In completely enclosed metal housing (not shown). Less low voltage DC supply \$62.50 Net

SPELLMAN TELEVISION CO., INC.

3029 WEBSTER AVENUE
N. Y. 67, N. Y.
Kingsbridge 7-0306



NEW CIRCUIT ELEMENT

Elcor's ISOPLY (Isolated Power Supply) Model A105-15A

- FEATURES EXTREMELY LOW SHUNT CAPACITANCE
- SOLVES MANY DIRECT-COUPPLING PROBLEMS
- SMALL • RUGGED • UNIQUE

This new miniature regulated power supply can be used in circuit applications requiring a power supply that is both conductively and capacitively isolated from ground.

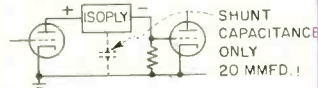

SPECIFICATIONS

Input.....110-125 v, 60 cps Dimensions 2¼" x 1½" x 5½"
Shunt capacitance...20 MMFD. Output...105 v. 0-15 ma., d.c.
Output ripple.....less than .1 volt
Regulation, no load to full load......1%
(Model A105-15F supplied with filament winding)

ELCOR, INC.

• P.O. BOX 354, McLEAN, VA.

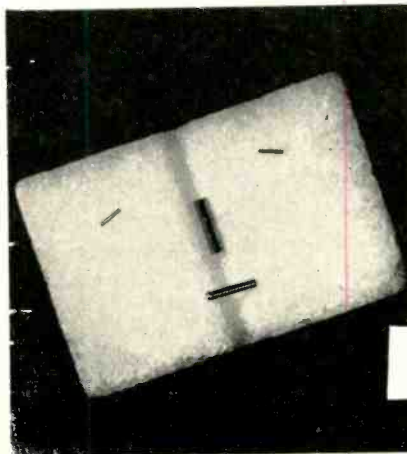

WORRIED ABOUT PRECISION PIVOTS?

Call **W**

Steel, chromium plated, or carbide precision pivots to .013" diameter. 1 RMS or finer surface finish. Diameter tolerances to .000010". Chamfers, radii, lapped ends, etc.

Also volume production lapping of flat or round production parts.

Submit your specifications

THE VAN KEUREN COMPANY
176-D WALTHAM STREET
WATERTOWN, MASS.

The photographer's nightmare at the left consists of a lump of sugar and four VK Precision Parts. The "eyes" are .080" long.

**FOR FASTER WORK
MORE PERFECT WORK**

USE **Busch**



**CUTTING BURS &
MOUNTED STONES
FOR LIFETIME SERVICE**

Control the quality of your product with these high quality German Tungsten Vanadium Steel Burs. (Famous Since 1905) . . . They are sharper . . . keep keen edge longer. Over 1001 Shapes and Sizes . . . One to meet every need . . . every operation. Can be used on any flexible shaft machine or drill on plastics, metals, etc., also Reamers and Mounted Stones.

**SAVE MONEY IN YOUR
PLANT NOW**

Write today for FREE FOLDER
& Price List.

PFINGST & CO., INC.

(Exclusive U. S. Importers)
58 Cooper Square New York 3, N. Y.

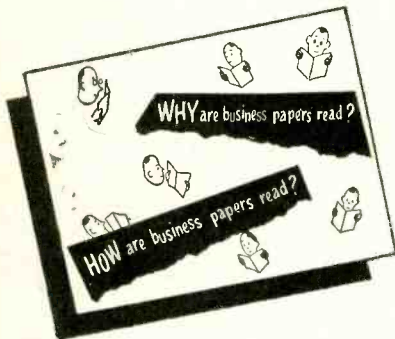

A copy of this quick-reading, 8-page booklet is yours for the asking. It contains many facts on the benefits derived from your business paper and tips on how to read more profitably. Write for the "WHY and HOW booklet."

• • • • •
McGraw-Hill Publishing Company, Room 2710, 330 West 42nd St., New York 36, N. Y.

Lapp Insulator Co., Inc.	264	Oak Mfg. Co.	79
Leach Corporation	71	Offner Electronics	457
Leach & Garner Co.	374	Omega Industries, Inc.	488
Lear, Inc.	258, 259	Opad Electric Co.	466
Leeds & Northrup Company	65	Oster Manufacturing Co., John.	138
Lennard Co., Inc., P. M.	479		
Lewis Spring & Mfg. Co.	390		
Linde Air Products Co.	44		
Lockheed Aircraft Corp., Missile Systems Div.	300, 301	Pace Electrical Instrument Co., Inc.	483
		Packard Bell Electronics, Technical Products Div.	52
		Panoramic Radio Products, Inc.	128
		Perkin-Elmer Corp.	441
MacDonald, Inc., Samuel K.	493	Perkin Engineering Corp.	25
Mack Electronics Division Inc., of Mack Trucks, Inc.	327	Perkins Machine & Gear Co.	453
Magnatran, Inc.	482	Permag Corp.	486
Magnetic Amplifiers, Inc.	324	Peters-Dalton, Inc.	39
Magnetics, Inc.	225	Phelps-Dodge Copper Products Corp. Inca Mfg. Div.	56, 57
Magnetics Research Company.	446	Pfingst & Co., Inc.	556
Maguire & Co., J. A.	493	Phalo Plastics Corp.	217
Maigne Co., O. J.	469	Philadelphia Bronze & Brass Co.	129
Mulco Tool & Mfg. Co.	435	Phileo Corporation	349
Mallory and Co., Inc., P. R.	154, 207	Phillips Control Corp.	330
Marconi Instruments, Ltd.	415	Pix Manufacturing Co., Inc.	476
Marion Electrical Instrument Co.	247	Polarad Electronics Corporation	34, 35, 237, 345
Martin Company, Glenn L.	384	Polytechnic Research & Development Co., Inc.	235
Maxson Corp., W. L.	471	Popper & Sons, Inc.	459
Maxson Instruments	445	Potter & Brumfield, Inc.	399
MB Mfg. Company a Div. of Textron Inc.	232	Potter Company, Inc.	354
McCoy Electronics Co.	244	Potter Instrument Co., Inc.	427
McGraw Hill Book Co.	356	Precision Apparatus Co., Inc.	560
Measurements Corp.	447	Precision Capacitors, Inc.	469
Melpar, Inc.	236	Precision Disc Grinding Corp.	479
Metals & Controls Corp., General Plate Div.	395	Precision Paper Tube Co.	348
Mico Instrument Co.	467	Premier Metal Products Co.	434
Micro Switch a Division of Minneapolis Honeywell Regulator Company.	94, 95	Price Electric Corp.	378
Microtran Co., Inc.	461	Progress Electronics Co.	458
Microwave Associates, Inc.	472, 473	Progressive Enterprises, Inc.	491
Midland Mfg. Co., Inc.	141	Pyramid Electric Co.	347
Millen Mfg. Co., Inc., James.	283		
Millivac Instrument Corp.	27		
Milwaukee Gas Specialty Co.	454		
Minneapolis-Honeywell Regulator Co. Boston Division	407		
Industrial Division	315	RBM Division, Essex Wire Corp.	257
Moloney Electric Co.	295	Radiation, Inc.	366
Moseley Co., F. L.	434	Radio Corporation of America	144 4th Cover
Muirhead & Co., Ltd.	5	Radio Engineering Products	292
Mullard Overseas, Ltd.	124	Radio Frequency Laboratories, Inc.	294
		Radio Receptor Co., Inc.	213, 279
		Ramo-Wooldridge Corp.	255, 455, 469
		Raybestos-Manhattan, Inc.	397
		Rawson Electrical Instrument Co.	478
		Raytheon Mfg. Company.	18, 19, 30, 31 89, 98
		Reeves Instrument Corp.	125
		Rellance Mica Co., Inc.	444
		Relay Sales, Inc.	85
		Remington Rand Univac Div. of Sperry Rand Corp.	351
		Revere Corporation of America.	400
Narda Corporation	246		
Nems-Clarke, Inc.	481		
New England Transformer Co.	382		
New Hampshire Ball Bearings, Inc.	70		
New Hermes Engraving Machine Corp.	453		
Ney Company, J. M.	344		
Northern Radio Co., Inc.	143		
Nothelfer Winding Laboratories, Inc.	278		

Rheem Manufacturing Company, Electronics Laboratory	32A-32P
Robertshaw-Fulton Controls Company...	490
Rogan Brothers	482
Rome Cable Corp.	112
Royal Metal Mfg. Co.	301

Sanborn Company	100, 101
Sanders Associates, Inc.	442
Sangamo Electric Co.	134
Sealco Corporation	318
Sel-Rex Corp.	474
Sensitive Research Instrument Corp....	448
Shallcross Mfg. Corp.	386
Shelding, Inc.	333
Sierra Electronic Corp.....	138, 139
Simpson Electric Company.....	355
Skydyne, Inc.	442
Society of the Plastics Industry, Inc. ...	469
Sola Electric Co.	36
Sorensen & Co., Inc.	4
Southern Electronic Corp.	293
Specialty Automatic Machine Corporation	449
Spellman Television Co., Inc.....	555
Spencer-Kennedy Laboratories, Inc.....	317
Sperry Gyroscope Company, Division of Sperry Rand Corp.	116, 117, 239
Sprague Electric Co.	11, 277
Stackpole Carbon Co.	303
Standard Electric Time Co.....	40, 41
Star Porcelain Co.	471
Sterling Transformer Corp.	344
Stevens Arnold, Inc.	430
Stevens Mfg. Co., Inc.	463
Stoddart Aircraft Radio Co., Inc.....	451
Stromberg-Carlson Company	405, 450
Stupakoff Div. of the Carborundum Co.	329
Superior Electric Company.....	381
Superior Electronics Corp.	465
Superior Tube Co.	409
Surprenant Mfg. Co.	316
Sylvania Electric Products, Inc....	60, 140, 484

Taylor Fibre Co.	393
Technical Appliance Builders.....	485
Technical Appliance Corp.	463
Technicraft Laboratories Inc.....	352
Technology Instrument Corp.	388
Tektronix, Inc.	133
Tele-Dynamics Inc.	74
Tensolite Specialties Inc.	342
Texas Instruments, Incorporated... ..	215, 466
Thermal American Fused Quartz Co., Inc.	216
Thompson Products, Inc.	392
Thor Ceramics, Inc.	228
Tobe Deutschmann Corp.	262
Trad Electronics Corporation.....	326

no "ghosts" with CUSIL decarbonized brazing alloy

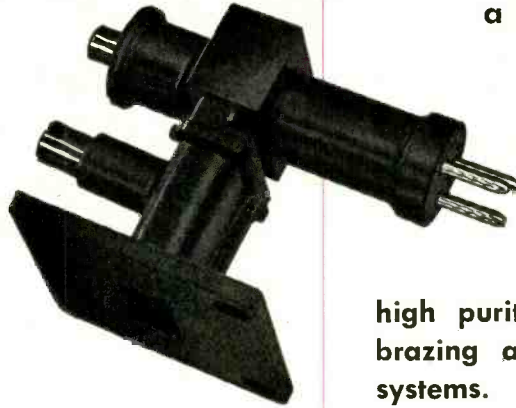

a Silver-Copper Eutectic
brazing alloy by

WESGO

... producers of
Nicoro, Nioro, In-
cosil and Incoro

high purity, low vapor pressure
brazing alloys for high vacuum
systems.

Decarbonization . . . an exclusive process for elimination of carbon and "dirt" ever present in silver brazing alloy wires. No "leakers" due to non-wetting characteristics of carbon. No free carbon particles in electron beam.

Write for additional information

Visit Us At IRE Convention — Booth 4202-4204

WESTERN GOLD & PLATINUM COMPANY
OUR NEW ADDRESS—BELMONT, CALIF.

→ → → → →
**PROTECT
YOUR PRODUCT**

at point of strain

Protect product sale-ability too — by insuring long life for cords, cables and conductors. Genuine "GRIPMASTER" Strain Reliefs provide these vital features—

- ★ Anchor cords to housing
- ★ Eliminate taping or threading
- ★ Prevent unraveling
- ★ Prevent cord pull damage
- ★ All sizes and styles
- ★ Easy to apply
- ★ Inexpensive

Gripmaster Strain Reliefs are "tremendous trifles" that make good products better!

Ask for samples.

4 WAYS TO END ALL CORD AND CABLE SERVICE FAILURES

Economically

GRIPMASTER STRAIN RELIEFS

Interruptions due to cable and cord connection failures are eliminated because they anchor the cord to the product at the point of strain. GRIPMASTER Strain Reliefs can withstand pulls up to 100 lbs., and are acceptable to Underwriters Laboratories. All types Reg. U. S. Pat. Off.

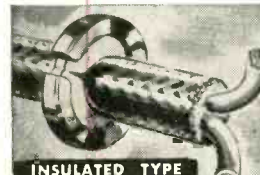

WIRE BINDING SLEEVES—Preventing fraying of cord ends, these specially-treated rubber tubes are available in five sizes to fit wires to .790



WRITE FOR SAMPLES AND LITERATURE TODAY!

GEORGE WALKER COMPANY

STRAIN RELIEF SPECIALISTS

118 AMSTERDAM AVE., PASSAIC, NEW JERSEY

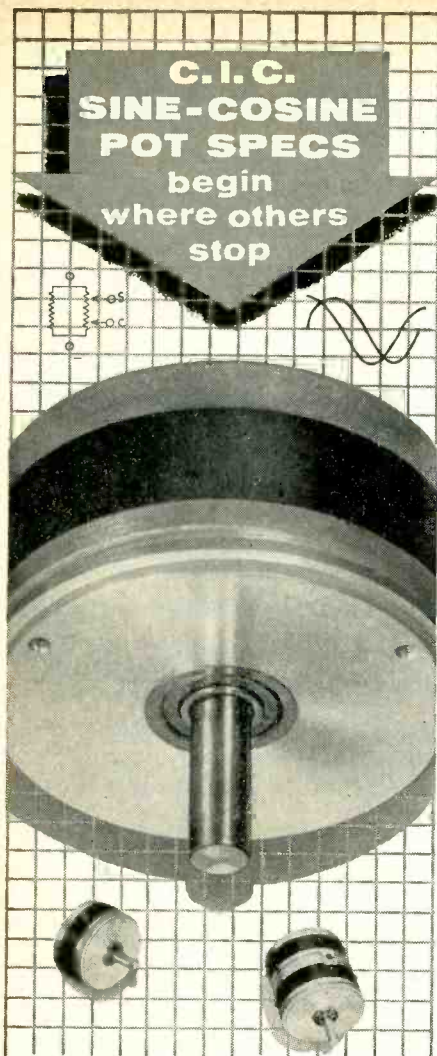

Infinite resolution and absolute dependability distinguish C.I.C. ultra-precise Potentiometers. In the generation of the sine wave C.I.C. Pots provide smooth, reliable performance, distortion free at all angles of rotation.

C.I.C. carbon film Sine-Cosine Pots, the proven product of a unique research program, provide greater accuracy in smaller case sizes. Sizes range from 1" to 5" diameter with corresponding best conformities from .3% to .03%. Compensation for loading can be provided with no loss of performance.

At speeds in excess of 1,000 r.p.m. C.I.C. guarantees life in excess of two million revolutions.

Many firms with critical specifications for industrial instrumentation, military fire control and flight guidance equipment rely only on C.I.C. Potentiometers.

Our highly qualified engineers are ready to discuss your specific requirements with you. Call us today.

"For Precision Performance ... specify C.I.C."

Detailed Technical Data Sheets available on request.

cic **COMPUTER INSTRUMENTS CORPORATION**

Ivanhoe 3-8200
92 Madison Ave. • Hempstead, Long Island, N. Y.

Want more information? Use post card on last page.

Transcoil Corp.	313	MANUFACTURERS REPRESENTATIVES	492, 493
Transitron Electronic Corp.	76, 77		
Trans-Sonics, Inc.	284		
Triad Transformer Corp.	288		
Trio Laboratories, Inc.	462		
Triplett Electrical Instrument Co.	114	PROFESSIONAL SERVICES	491
Tung-Sol Electric, Inc.	119		
Turbo Jet Products Co., Inc.	460		

Ucinite Co.	151
Union Switch & Signal Div. of Westinghouse Air Brake Company	418, 419
United-Carr Fastener Corp.	150
United Shoe Manufacturing Corp.	61
U. S. Components Inc.	336
U. S. Stoneware	275
United States Rubber	289
United Transformer Co.	2nd Cover
Uniwave, Inc.	459

Van Keuren Co., The.	555
Varflex Corporation	368
Vector Manufacturing Company	380
Vectron, Inc.	441
Veeder-Root, Inc.	373
Victoreen Instrument Co.	270
Volkers & Schaffer Mfg. Corp.	27

Waldes Kohinoor, Inc.	37
Walker Co. George	557
Waltham Watch Co.	340
Ward Leonard Electric Co.	55
Waterman Products Co., Inc.	312
Waters Manufacturing, Inc.	414
Weekesser Co.	471
Welch Scientific Co., W. M.	416
Weldmatic, Div. of Unitek Corp.	410
Western Gold & Platinum Company	557
Westinghouse Electric Corp.	365, 375, 389
Weston Electrical Instrument Corp., a Subsidiary of Daystrom, Inc.	331, 455
Wheelock Signals, Inc.	430
White Dental Mfg. Co., S. S.	328, 431
Whitso, Inc.	464
Wilton Tool Mfg. Co., Inc.	490

Zell Products Corp.	480
Zophar Mills, Inc.	459

<i>CLASSIFIED ADVERTISING</i> F. J. Eberle, Business Mgr.	
EMPLOYMENT OPPORTUNITIES	494-536
BUSINESS OPPORTUNITIES	536
EDUCATIONAL	536
EQUIPMENT (Used or Surplus New) For Sale	537-552
WANTED Equipment	548

**EMPLOYMENT OPPORTUNITIES
ADVERTISER'S INDEX**

Abbott's Employment Specialists	535
Admiral Corp.	504, 514, 523
Aeroflex Research Inc.	526
Aircraft Radio Corp.	530
Aladdin Electronics	524
Allied Research Assoc.	530
American Machine & Foundry Co.	525
Analogue Controls	520
Arma Div., American Bosch Arma Corp.	523
Armour Research Foundation of Illinois Institute of Technology	500
Avco Manufacturing Corp., Crosley Div.	506
Avion Div., ACF Industries Inc.	525
Baird Atomic Inc.	536
Balkany, John	535
Bendix Aviation Corp. Bendix-Friez Division	534
Products Div.	521
Products Division Missiles	508
Radio Division	503
York Division	522
Benrus Watch Co.	536
Burroughs Corp.	510
Carter, Frank	535
CDC Control Services Inc.	531
CGS Laboratories Inc.	526
Continental Oil Co.	533
Cooper, J.	534
Dynamic Electronics	533
Edison Inc., Thomas A.	530
Emerson Electric Electronics & Avionics Div.	512
Epseo, Inc.	528
Erco, Div. of ACF Industries	524

Federal Telecommunications Laboratories ..	521
Fidelity Personnel Service	535

General Electric Co.	
Philadelphia, Pa.	514
Syracuse, N. Y.	527
Utica, N. Y.	521
General Electronics Laboratories Inc.	533
General Motors Corp.	
AC Electronics Div.	498, 506, 529, 535
General Precision Laboratory Inc.	516
Goodyear Aircraft Corp.	
Akron, Ohio	501
Litchfield Park, Arizona.	508
Goodyear Atomic Corp.	527
Haller Raymond & Brown Inc.	522
Haloid Co.	516
Haynes Associates	533
Hoffman	513
Honeywell-Brown Instruments Division.	510
Hycor, Div. of Int'l Resistance Co.	522
Instruments for Industry.	525
International Resistance Co.	525
Kollsman Instrument Corp.	527
Lansdale Tube Co., Div. of Philco Corp. ...	528
Leeds Co., Gerard G.	518
Leeds & Northrop Co.	509
Lear Inc.	533
Machlatt Laboratories Inc.	536
Madigan Corp.	524
Magnetics Inc.	529
Martin Co., Glenn L. (Baltimore Div.) ...	500
Maryland Electronics Mfg. Corp.	502
Minneapolis Honeywell Boston Div.	504
Monarch Personnel	534
Motorola Inc.	502
Munston Mfg. Service Inc.	522
New York State Employment Service.	535
Norden-Ketay Corp.	520
Otis Elevator Co.	523
Page Communications Engineers Inc.	522
Pennsylvania State University.	532
Radio Corp. of America.	494, 495
Radio Receptor Co.	526
Raytheon Manufacturing Co.	496, 497, 507, 517
Reflectone Corp.	535
Republic Aviation	515
Sanders Associates Inc.	529
Schlumberger Well Surveying Corp.	520
Spengler, Silas	518
Stavid Engineering Inc.	498
Stromberg-Carlson Co.	
A Division of General Dynamics Corp. ...	505
	520
Sylvania Electric Products Inc.	
Buffalo, N. Y.	519
Waltham, Mass.	511
Woburn, Mass.	499
Tracerlab	532
Trans-Sonics, Inc.	531
Westinghouse—Electronic Tube Division. ...	518

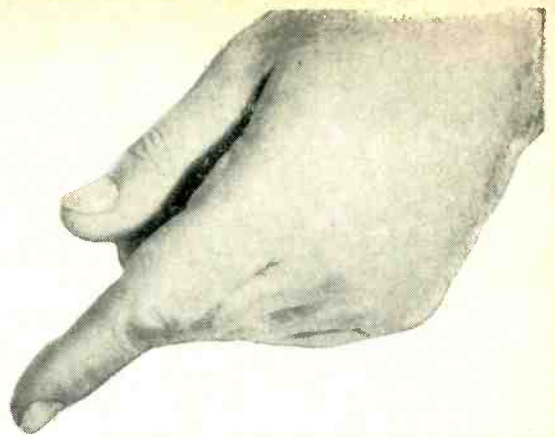

How to keep informed on the “with what” part of your business

AT YOUR FINGER TIPS, issue after issue, is one of your richest veins of job information — advertising. You might call it the “with what” type — which dovetails the “how” of the editorial pages. Easy to read, talking your language, geared specifically to the betterment of your business, this is the kind of practical data which may well help you do a job quicker, better — save your company money.

Each advertiser is obviously doing his level best to give you helpful information. By showing, through the advertising pages, how his product or service can benefit *you* and *your* company, he is taking *his* most efficient way toward a sale.

Add up all the advertisers and you've got a gold mine of current, on-the-job information. Yours for the reading are a wealth of data and facts on the very latest in products, services, tools . . . product developments, materials, processes, methods.

You, too, have a big stake in the advertising pages. Read them regularly, carefully to keep job-informed on the “with what” part of your business.

McGRAW-HILL PUBLICATIONS



MORE RANGES VISIBILITY V.O.M.

the *PRECISION* model



120

*Gives You What
You've Always
Wanted in a*

HIGH-SENSITIVITY MULTI-RANGE TEST SET

20,000 OHMS PER VOLT D.C.
5,000 OHMS PER VOLT A.C.

- ◆ **MORE RANGES** — 44 of them . . . starting lower and going higher . . . outranging any professional V.O.M. of similar size or type.
- ◆ **AN EXTRA-LOW RESISTANCE RANGE** — 2-ohm center scale range, powered by long-lived, internal 1.5 volt battery source.
- ◆ **AN EXTRA-LOW VOLTAGE RANGE** — 1.2 volts full scale, A.C. and D.C.
- ◆ **AN EXTENDED LOW CURRENT RANGE** — 60 microampere first D.C. current range.
- ◆ **A LARGER AND EASIER-READING SCALE FACE** — extra-large 5¼" meter with full 4¾" extra-wide window.
- ◆ **SIMPLE, POSITIVE RANGE SELECTION** — 18-position, positive-detenting, master range selector with low-resistance, dependable, silver-plated contacts.
- ◆ **RUGGED, POSITIVE CONTACT JACKS and PLUGS** — specially designed, low-resistance, solid brass, banana type plugs and jacks.

Compare these Wide-Spread Ranges and Special Features:

- ★ **8 DC VOLTAGE RANGES:** 20,000 ohms per v. 0-1.2-3-12-60-300-600-1200-6000 v.
- ★ **8 AC VOLTAGE RANGES:** 5,000 ohms per v. 0-1.2-3-12-60-300-600-1200-6000 v.
- ★ **8 AC OUTPUT RANGES:** same as AC volt ranges. Built-in 600 volts blocking capacitor.
- ★ **7 DC CURRENT RANGES:** 0-60-300 Microamperes. 0-1.2-12-120-600 Ma. 0-12 Amperes.
- ★ **5 RESISTANCE RANGES:** self-contained. 0-200-2000-200,000 ohms. 0-2-20 megohms.
- ★ **8 DECIBEL RANGES:** from -20 to +77 DB. 0 DB=1 Milliwatt, 600 ohms.
- ★ **EXTRA LARGE 5¼" RUGGED 'PACE' METER:** 40 microamperes sensitivity, 2% accuracy.
- ★ **1% MULTIPLIERS and SHUNTS:** wire-wound and deposited-film types employed throughout.
- ★ **ONLY 2 PLUG-JACKS SERVE ALL STANDARD RANGES:** separately identified and isolated jacks provide for extra-high ranges.
- ★ **"TRANSIT" SAFETY POSITION** on master range selector protects meter during transportation and storage.
- ★ **CUSTOM-MOLDED PHENOLIC CASE and PANEL:** compact, efficient, laboratory instrument styling. Deeply engraved panel characters afford maximum legibility.

MODEL 120: complete with internal ohmmeter batteries, banana-plug test leads and operating manual. Over-all case dimensions: 5¾ x 7 x 3¾ inches. Net Price: \$44.95



PRECISION Apparatus Company, Inc.

70-31 84th Street, Glendale 27, L. I., N. Y.

Export: 458 Broadway, New York 13, N.Y., U.S.A. • Cables: MORHANEX
Canada: Atlas Radio Corp. Ltd. • 50 Wingold Ave., Toronto 10, Ontario

SEARCHLIGHT SECTION ADVERTISER'S INDEX

Algeradio Electronics Co. 540
Arrow Sales Inc. 544, 548
Atlantic & Pacific Wire & Cable Co. 550

Barry Electronics Corp. 540, 542, 544
548, 549, 550
Belvision Inc. 538
Binneweg Television 536
Blan 549
Bolton Laboratories 540

C & H Sales Co. 539
Communications Devices Co. 547
Communications Equipment Co. 542
Compass Electronics Supply Co. 548
Cowan Publishing Corp. 536

Dutchess Labs 538, 548

Electro Sales Co. 546, 551
Engineering Associates 544
Estes & Co., Sanford. 540, 550

Fair Radio Sales 542
Fay-Bill Distributing Co. 551
Finnegan, H. 548

Harjo Sales Co. 546, 548
Hershel Radio Co. 544
Honde Supply Co. 546

Instrument Service Co. 550

JSH Sales Co. 541

Lelectronics Research Laboratories. 549
Liberty Electronics Inc. 546

M. R. Co., The. 548
McNeal Electric & Equipment Co. 551
Milano Brothers 550
Monmouth Radio Labs. 543
Montgomery Equipment Co. 542

Pacific International University. 536
Page Electronics 550

Radalab Inc. 547
Radio & Electronics Surplus. 548
Radionic Products Co. 540
Radio Research Instrument Co. 545
Red Arrow Electronics Sales Co. 542
Relay Sales Inc. 551
Rex Radio Supply Co. 546

Seg Electronics Co. Inc. 538

"TAB" 537
Telemarine Communications Co. 545

V & H Radio & Electronics. 538

Western Engineers 543
Wilgreen Industries 549

Universal Relay Corp. 540

This index is published as a service to the readers. Every care is taken to make it accurate, but ELECTRONICS assumes no responsibility for errors or omissions.

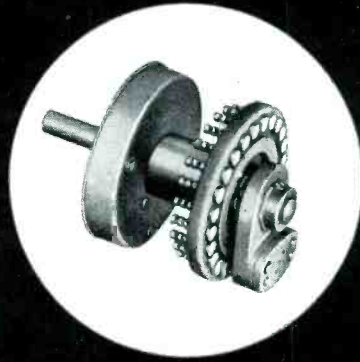

Consult DAVEN for the finest in electronics

- PRECISION WIRE WOUND RESISTORS
- ROTARY SWITCHES
- ATTENUATORS
- TEST AND MEASURING INSTRUMENTS

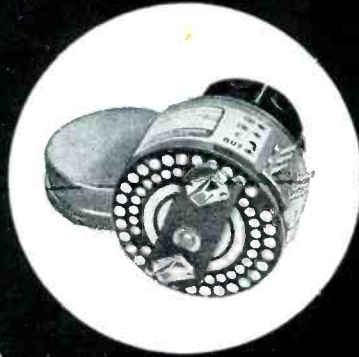

Outstanding achievement in the design of precision wire wound resistors, rotary step-type switches, attenuators and test equipment has established DAVEN as the leading producer and supplier of precision electronic components and instruments.

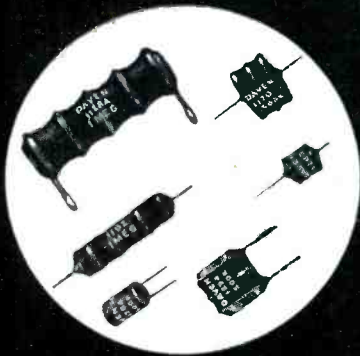

When confronted with a procurement or design problem concerning precision wire wound resistors, rotary switches, attenuators or test equipment, consult DAVEN's sales department or engineering staff first.

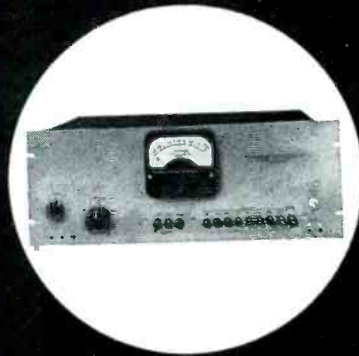

THE **DAVEN** CO.

526 West Mt. Pleasant Avenue, Livingston, New Jersey

TODAY, MORE THAN EVER, THE DAVEN  STANDS FOR DEPENDABILITY!





RCA CERAMIC-METAL POWER TUBES

...for new dimensions in military and industrial electronics

To meet the challenges posed by expanding design requirements of military and industrial electronics, RCA began years ago to design Ceramic-Metal Power Tubes. These unique power tubes utilize low-loss, high-strength ceramic bushings... provide exceptionally reliable and efficient service at higher frequency and power levels.

Today, RCA offers a selection of Ceramic-Metal Power Tubes for a large variety of applications... from compact UHF beam power types to Super-Power types providing unprecedented levels of cw power output.

VISIT RCA EXHIBIT AT I. R. E. SHOW—1st FLOOR—N. Y. COLISEUM!

RCA Ceramic-Metal Power Tubes in Class C Telegraphy Service		
Type	Max. Freq. For Full Input (Mc)	Max. Plate Input (Watts)
618T	900	2,500
6816, 6384	1,200	180
6806	1,000	60,000
6448	1,000	45,500
6949	75	1,100,000

For information on how RCA Ceramic-Metal Power Tubes can help solve your industrial and military equipment design problems, contact your RCA representative at the office nearest you.

EAST: Humboldt 5-3900
744 Broad Street
Newark 2, N. J.

MIDWEST: Whitehall 4-2900
Suite 118T,
Merchandise Mart Plaza
Chicago 54, Ill.

WEST: Raymond 3-8361
6355 East Washington Blvd.
Los Angeles 22, Calif.

For technical bulletins on specific types, write RCA Commercial Engineering, Section C19Q1, Harrison, N. J.



RADIO CORPORATION of AMERICA

® Tube Division

Harrison, N. J.